

Wiener algebras of Fourier integral operators

Original

Wiener algebras of Fourier integral operators / Elena, C., Karlheinz, G., Nicola, F., Luigi, R.. - In: JOURNAL DE MATHÉMATIQUES PURES ET APPLIQUÉES. - ISSN 0021-7824. - STAMPA. - 99:(2013), pp. 219-233.
[10.1016/j.matpur.2012.06.012]

Availability:

This version is available at: 11583/2498012 since: 2015-12-28T11:44:21Z

Publisher:

ELSEVIER

Published

DOI:10.1016/j.matpur.2012.06.012

Terms of use:





This article is made available under terms and conditions as specified in the corresponding bibliographic description in the repository

Publisher copyright

(Article begins on next page)

Article

Fungal Biota and Mycotoxins Contamination in Soybean Expeller

Gisele Maciel ^{1,*}, Claudia Carla Castellari ², Leandro Marcelo Cardoso ¹, María Bernadette Abadía ¹,
Patrizia Busato ³ and Ricardo Enrique Bartosik ¹

¹ IPADS Balcarce (INTA-CONICET), RN 226 km 73.5, Balcarce 7620, Argentina; cardoso.marcelo@inta.gob.ar (L.M.C.); abadia.maria@inta.gob.ar (M.B.A.); bartosik.ricardo@inta.gob.ar (R.E.B.)

² Laboratorio de Microbiología de Suelos y Alimentos, Facultad de Ciencias Agrarias, Universidad Nacional de Mar del Plata, RN 226 km 73.5, Balcarce 7620, Argentina; ccastellari@mdp.edu.ar

³ Interuniversity Department of Regional and Urban Studies and Planning (DIST), Polytechnic of Turin, Viale Pier Andrea Mattioli 39, 10125 Torino, Italy; patrizia.busato@polito.it

* Correspondence: maciel.gisele@inta.gob.ar

Abstract: Soybean expeller (SBE), a by-product of soybean oil extraction through the extruding-expelling process, is widely used as a protein source in animal feed and soy-based foods. This study evaluated fungal contamination and mycotoxin levels in SBE samples from 11 extruding-expelling facilities in Argentina, assessing fungal load, moisture content (MC), and mycotoxin profiles. Fungal biota was quantified through colony forming unit (CFU) counts and identified via morphological analysis, while mycotoxins were quantified using liquid chromatography and tandem mass spectrometry. CFU counts were low (0 to 4 CFU g⁻¹ DM), with *Penicillium* spp. (28.0%) and *Mucoraceae* (family) (25.6%) being the most frequently isolated genera. Deoxynivalenol (DON) and aflatoxins (AFB₁, AFB₂, AFG₁, and AFG₂) were detected in 20% to 40% of the samples. The average concentration was 215.19 µg kg⁻¹ for DON and 41.68, 0.39, and 0.34 µg kg⁻¹ for AFB₁, AFG₁, and AFG₂, respectively. Although most mycotoxin concentrations were below regulatory limits, a few samples exceeded the threshold for DON (8.6%) and AFB₁ (2.9%). Co-occurrence of two mycotoxins was observed in 60% of the samples. These results highlight the importance of monitoring fungal contamination and mycotoxin levels to ensure the safety and quality of SBE for feed and food applications.

Keywords: animal feed; extruding-expelling process; microbiological quality; soybean by-product; toxigenic microbiota



Received: 12 February 2025

Revised: 21 March 2025

Accepted: 22 March 2025

Published: 25 March 2025

Citation: Maciel, G.; Castellari, C.C.; Cardoso, L.M.; Abadía, M.B.; Busato, P.; Bartosik, R.E. Fungal Biota and Mycotoxins Contamination in Soybean Expeller. *Agronomy* **2025**, *15*, 807. <https://doi.org/10.3390/agronomy15040807>

Copyright: © 2025 by the authors. Licensee MDPI, Basel, Switzerland. This article is an open access article distributed under the terms and conditions of the Creative Commons Attribution (CC BY) license (<https://creativecommons.org/licenses/by/4.0/>).

1. Introduction

Soybean expeller (SBE), a by-product obtained during the extruding-expelling process of soybean oil extraction [1], is highly valued as a protein-rich component in animal feed and soy-based food products [2–5]. In Argentina, nearly one million tons of SBE are produced annually [6] in 373 extruding-expelling facilities, primarily located in the Pampa's region [7]. The average composition of SBE in Argentina is 7.2% moisture, 44.2% protein, and 8.1% residual oil [8,9], aligning with the values set by Standard XIX [10] for commercialization. Despite its economics and nutritional importance, SBE is susceptible to fungal contamination and mycotoxin accumulation, which can pose significant risk to both animal and human health [11,12].

Fungal contamination in soybean can occur during cultivation in the field, transportation, storage, and processing [13]. Under improper storage conditions—such as high relative humidity (>70%) and temperature [14–17]—fungus can proliferate in soybean seed and expeller, leading to the production of mycotoxins and overall quality degradation [18–22]. Common mycotoxins associated with soybean products include deoxynivalenol (DON) and aflatoxins (AFs), produced by fungal genera such as *Fusarium* and *Aspergillus* [23–26]. These toxins are a major concern due to their adverse health effects and the lack of established regulation limits in Argentina for food and feed applications.

DON is a mycotoxin produced by *Fusarium culmorum* and *Fusarium graminearum*, commonly found in various cereal crops such as wheat, maize, barley, oats, and rye [27]. These fungi synthesize mycotoxins in field crops, leading to contamination at pre-harvest stages. DON is a widespread contaminant in wheat, with a reported prevalence of 57% in 11,444 tested samples globally [28]. At the cellular level, DON inhibits DNA, RNA, and protein synthesis by targeting ribosomes, resulting in erythrocyte hemolysis [29]. Its systemic toxic effects include feed refusal, reduced weight gain, gastroenteritis, diarrhea, emesis, nutrient malabsorption, cardiotoxicity, teratogenicity, and immunotoxicity [30,31].

Aflatoxins are a class of mycotoxins produced by *Aspergillus* species, primarily *Aspergillus flavus* and *Aspergillus parasiticus* [32]. These fungi are commonly found in soil and various organic materials and are known to synthesize toxins during grain storage. While *A. flavus* strains produce only aflatoxins B₁ (AFB₁) and B₂ (AFB₂), *A. parasiticus* strains can synthesize AFB₁, AFB₂, G₁ (AFG₁), and G₂ (AFG₂) [33]. Notably, AFB₁ is the most potent hepatocarcinogen identified in mammals and is classified as a Group I carcinogen by the IARC [30,34].

Aflatoxins are among the most extensively studied mycotoxins worldwide due to their significant impact on food safety and health. They have been linked to various diseases, including aflatoxicosis in livestock, domestic animals, and humans. Their potent carcinogenicity in susceptible laboratory animals and acute toxicological effects in humans have led to heightened global concern and regulatory attention [35,36].

Previous studies have documented mycotoxin contamination in soybean and related by-products, such as soybean meal [19,37–39]; however, limited information is available regarding mycotoxin levels specifically in SBE. Additionally, mycotoxigenic species belonging to the genera *Alternaria*, *Fusarium*, *Penicillium*, and *Aspergillus* have been reported in both recently harvested and stored soybeans [19,22,40–43]. Despite the widespread use of SBE as a feed ingredient, the relationship between fungal load, moisture content (MC), and mycotoxin contamination in SBE remains poorly understood, making its microbiological safety a critical concern. However, no national or international standards specifically regulate the microbiological quality or mycotoxin presence in SBE. In response, major animal feed manufacturers have begun assessing microbiological quality based on European regulations. Mycological criteria—such as the threshold of $\leq 10^4$ CFU/g—are currently established only for other soybean-derived products used in feed [44].

This study aims to address these gaps by evaluating the microbiological quality of SBE obtained from various extruding-expelling facilities located in the Argentine Pampa's region by (1) quantifying and identifying the fungal biota, including filamentous fungi and yeasts, present in SBE; (2) assessing the correlation between SBE MC and fungal biota load; and (3) determining the presence of mycotoxins in SBE. The findings will contribute to improving quality control practices and enhancing the safety of SBE for feed and food applications.

2. Materials and Methods

2.1. Sampling of Soybean Expeller

SBE samples were obtained during the 2015 and 2016 harvest seasons from 11 extruding-expelling facilities located in the Pampa's region of Argentina, covering the provinces of Buenos Aires (6), Santa Fe (2), Córdoba (2) and Entre Ríos (1). The 11 facilities represent 3% of the extruding-expelling facilities of Argentina. In each facility, three to eight separate SBE samples (obtained in three consecutive days, 5 kg each) were collected directly from the screw press outlet (Figure 1) and placed in double hermetic plastic bags to avoid moisture variations until use ($n = 33$). The initial sampling plan considered three samples per facility; however, logistical factors allowed for additional sampling in some locations, resulting in an unbalanced dataset, which was only used for mycotoxin analysis ($n = 41$). Of each sample, approximately 4.5 kg were stored at 4 °C for fungal biota analysis, following the same procedure as described by Castellari et al. [18]. This storage was for preservation purposes, preventing fungal growth until analysis, which was conducted within seven days. Additionally, 0.5 kg was stored at −18 °C for mycotoxin determination and was analyzed within one month.

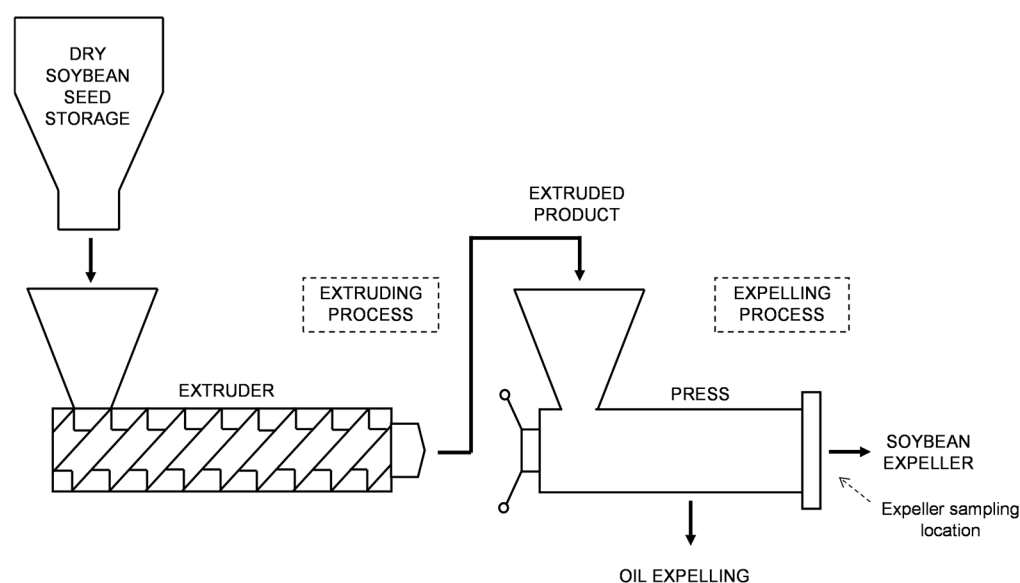

Figure 1. Conceptual diagram of extruding-expelling process.

2.2. Moisture Content Measurement

The MC of each SBE sample was determined in triplicate with the oven-drying method [45] at 103 °C for 72 h. Results were expressed on a dry basis (% d.b.).

2.3. Quantification and Identification Methods of Fungal Biota

Fungal biota (filamentous fungi and yeasts) was evaluated at the Soil and Food Microbiology Lab (FCA-INTA Balcarce, Balcarce, Argentina) by the method of serial dilutions. Ten grams of each SBE sample was homogenized in 90 mL of peptone water solution (one g casein peptone/L, Britania[®], Ciudad Autónoma de Buenos Aires, Argentina) for 15 min at 120 rpm in an orbital plane shaker (BM021, BIOMINT, Florida Oeste, Argentina), with four independent replicates. The 10th-fold serial dilution (10^{-1}) method in a tube was used, and 0.1 mL aliquots from each dilution were inoculated in duplicate in Petri dishes with potato dextrose agar (PDA, Britania[®], Ciudad Autónoma de Buenos Aires, Argentina) at 2% and 0.1 g/L of chloramphenicol (Anedra[®], Troncos del Talar, Argentina) to inhibit bacterial growth. PDA with antibiotics medium was used for the cultivation and enumeration of yeast and filamentous fungi (molds) from SBE [46]. After five to seven days of incubation

at 28 °C, filamentous fungi and yeast colonies were counted, and the results expressed as colony-forming units per gram of dry matter (CFU g⁻¹ DM) [47].

The identification of fungal biota in SBE was performed in the Petri dishes based on vegetative hyphae (in vitro culture medium: malt extract medium-MEA and sucrose medium-CYA) and microscopic (Olympus BH2, PR, USA) (asexual spores and sexual spores) characteristics [47,48]. The results were expressed as isolation frequency (Equation (1)), defined as the percentage of samples in which each genus was detected, and as relative density (Equation (2)), defined as the proportion of each genus isolated relative to the total genus isolated at each specific extruding-expelling facility [49,50].

$$\text{Isolation frequency(\%)} = \frac{ns}{N} \times 100 \quad (1)$$

where *ns* is the number of samples contaminated with a specific genus, and *N* is the total number of samples.

$$\text{Relative density(\%)} = \frac{ni}{Ni} \times 100 \quad (2)$$

where *ni* is the number of isolates belonging to a specific genus, *Ni* is the total number of genus isolated from a specific extruding-expelling facility.

2.4. Mycotoxins Analysis

The mycotoxins analysis was carried out at the Institute of Food Technology (INTA Castelar, Castelar, Argentina). The evaluated mycotoxins were AFB₁, AFB₂, AFG₁, AFG₂, nivalenol (NIV), DON, 13 acetyl DON, 15 acetyl DON, ochratoxin A, and zearalenone. The mycotoxin analysis was performed in SBE collected from all facilities except facilities 5 and 6, due to operational restrictions (*n* = 35). For mycotoxin analysis, 500 g from each SBE sample was ground in a laboratory grinder (Fw-100, Arcano, Beijing, China) and homogenized. The determination was carried out as described by Castañares et al. [51] with some experimental modifications. Firstly, 10 g of each sample was suspended in 20 mL of extraction solvent (acetonitrile: water: acetic acid; 79:20:1) with the addition of 2 g of NaCl. The samples were homogenized with Ultra-Turrax[®] (IKA Labortechnik, Staufen, Germany) for 3 min, sonicated for 60 min, and centrifuged for 5 min at 3000 rpm (LC-75R, Luguimac[®], Buenos Aires, Argentina). A volume of 10 mL extract was transferred into glass vials and evaporated to dryness at 45 °C under a stream of N₂. The samples were resuspended in 2 mL of acetonitrile:water (70:30). They were then diluted with 28 mL of ultrapure water and purified with an SPE C18 cartridge (Strata C18-E, 55 µm, 70A, 500 mg/6 mL, Phenomenex, Cheshire, UK). The cartridge was washed with 2 mL of methanol:water (1:99) and eluted with 1 mL of methanol:water (70:30). Finally, they were filtered through a 0.2 µm polyvinylidene fluoride (PVDF) membrane and injected into a liquid chromatogram/tandem mass spectrometer (LTQ-XL[™] Linear Ion Trap Thermo, San Jose, CA, USA). Chromatographic separations were performed with a C18 100 2.1 mm Hypersil[™] ODS (Thermo Fisher, Waltham, MA, USA) (5 mm particle size) column. A solution of ammonium formate (10 mM) and acetonitrile was used as a mobile phase. Samples (10 µL) were analyzed at a flow rate of 0.2 mL/min at 45 °C. The mass-spectrometer acquisition settings were electrospray ionization (ESI) negative or positive (Table A1), retention time and abundance of the confirmation ion (Ion C) relative to that of quantification ion (Ion Q) were used as identification criteria.

The quantitative determination was performed using the following Sigma-Aldrich standards: B-trichothecene mix (part number: 34134), aflatoxin mix (part number: CRM46303), ochratoxin A solution (part number: 34037), and zearalenone solution (part number: 34126). Non-detected values were assumed as half the limit of detection (LOD), and values below the limit of quantification (LOQ) were assumed as half the LOQ [52,53].

2.5. Statistical Analysis

CFU counts and SBE MC data were analyzed as a completely randomized design using the R software (version 4.3.0, 21 April 2023) [54]. Each facility was considered a different treatment, and each sample (collected over three consecutive days) represents an independent experimental unit. A non-parametric Kruskal–Wallis test was performed for CFU data, followed by a Dunn’s test with Bonferroni correction ($\alpha = 0.05$) [55,56]. In addition, a Pearson correlation analysis was carried out between counts of CFU g⁻¹ DM and SBE MC.

Mycotoxin concentration in SBE samples from different extruded-expelling facilities was characterized through descriptive statistics (means and standard deviation (SD) was performed only with quantified samples). A Pearson correlation was performed to analyze linear relationships between pairs of mycotoxins. All statistical analyses were performed using the R software (version 4.3.0, 21 April 2023) [54].

3. Results

3.1. Quantification and Identification of Fungal Biota

The Figure 2 presents the mean fungal counts (CFU g⁻¹ DM) alongside the mean MC of SBE samples from different extruding-expelling facilities. Fungal counts in SBE samples were low, with mean values ranging from 0 to 4 CFU g⁻¹ DM. The highest average was 1.66 ± 3.99 CFU g⁻¹ DM (recorded in Facility 11), while the lowest average was 0.01 ± 0.03 CFU g⁻¹ DM (Facility 3). The highest CFU g⁻¹ DM values were 16.17, 15.36, and 14.64 in one of the four replicates of samples corresponding to Facilities 8, 11, and 1, respectively. No significant differences in CFU averages were found among the facilities ($p > 0.05$ in the Dunn test).

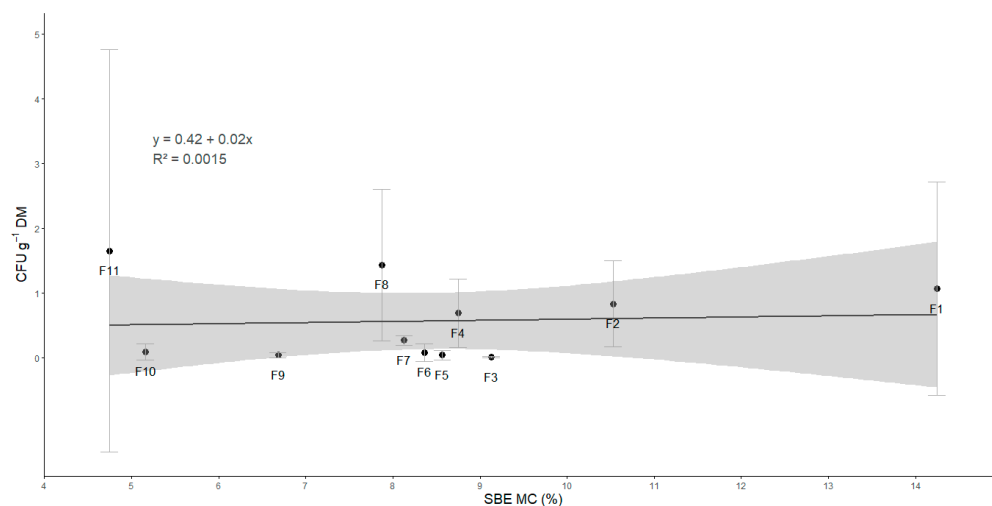

Figure 2. Relationship between average values of soybean expeller moisture content (SBE MC) and counts of colony forming units (CFU g⁻¹ DM) for different extruding-expelling facilities. The dots represent the averages, and the bars, the standard deviation. R² is the determination coefficient of the fitted linear model. F1 to F11 corresponds to Facility 1 to 11, respectively.

Seven genera of filamentous fungi belonging to upper taxonomic classes were identified in the SBE samples, including *Acremonium* sp., *Alternaria* sp., *Aspergillus* spp., *Cladosporium* sp., *Eurotium* sp., *Fusarium* sp. and *Penicillium* spp., as well as one genus from the lower taxonomic class *Mucoraceae* (family). Figure 3 shows the macroscopic morphology of some of these genera, which served as the basis for their identification. Due to unforeseen data loss, images for every detected genus could not be provided. *Penicillium* and *Mucoraceae* were the most frequently isolated (28.0% and 25.6%, respectively), followed

by *Aspergillus* (15.5%) and *Cladosporium* (14.3%). The isolation frequency of the remaining fungi were below 10%, while the yeasts exhibited an isolation frequency of 11.9%. These results indicate that no single genus predominated in the SBE samples.

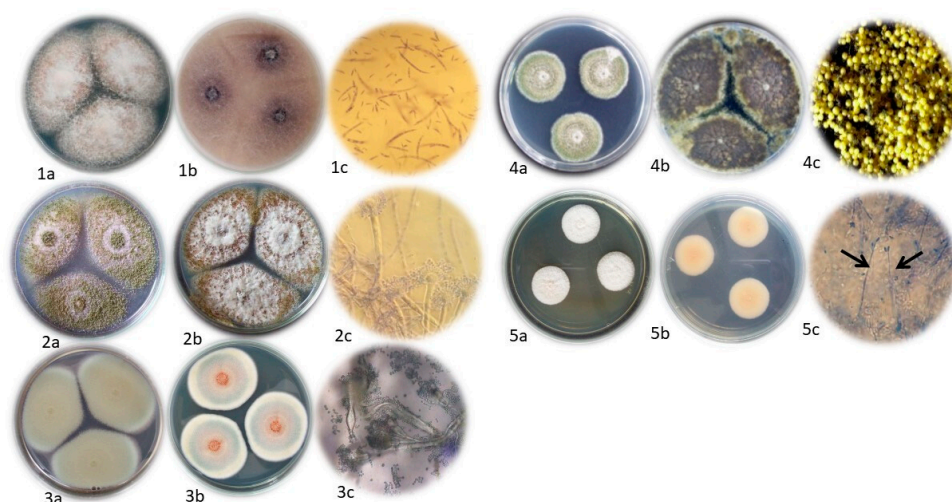

Figure 3. Macroscopic morphology of fungal colonies grown on 90 mm Petri dishes with MEA (a) and CYA (b) media, along with reproductive structures and spores of the identified fungi (c): (1a,1b) *Fusarium* sp.; (1c) asexual spores (optical microscope, 400 \times); (2a,2b) *Aspergillus flavus*; (2c) asexual reproductive structures (optical microscope, 400 \times); (3a,3b) *Penicillium* sp.; (3c) asexual reproductive structures (optical microscope, 400 \times); (4a,4b) *Eurotium* sp.; (4c) cleistothecia (optical microscope, 10 \times); (5a,5b) *Acremonium* sp.; (5c) asexual reproductive structures (optical microscope, 400 \times), black arrows indicate conidiophores. Photographs were captured using an Olympus camera (850,000 pixels, 3 \times zoom) (CAMEDIA, Tokyo, Japan).

An analysis of the relative density of extruding-expelling facilities revealed that total yeasts, *Penicillium*, and *Mucoraceae* were detected in the most of the facilities evaluated, although the percentage in the composition of the total mycobiota was variable (Table 1). Total yeasts were found in all facilities, with relative density values ranging from 0.5 to 100%. *Penicillium* was present in nine facilities, with values ranging from 1.9 to 93.8%, and *Mucoraceae* was identified in eight facilities, with relative density values between 0.9 and 79%. Among potentially mycotoxigenic genera (*Alternaria*, *Aspergillus* and *Fusarium*), *Aspergillus* was isolated in six facilities with relative density values ranging from 0.3% to 68.8%. *Alternaria* was identified in three facilities with values between 0.3 and 0.9%, while *Fusarium* was isolated in only one facility with a relative density value of 46%.

Table 1. Relative density of mycotoxigenic fungi and total yeast in soybean expeller samples discriminated by extruded-expelling facilities.

Facility ID	<i>Alternaria</i> spp.	<i>Aspergillus</i> spp.	<i>Fusarium</i> spp.	<i>Mucoraceae</i> (family)	<i>Penicillium</i> spp.	Total Yeasts	Other
Facility 1	0.5	0.5	0	77.0	7.8	3.6	10.6
Facility 2	0	6.2	46.0	0.9	4.5	37.4	5.0
Facility 3	0	0	0	0	0	100	0
Facility 4	0	0	0	2.6	7.3	52.3	37.7
Facility 5	0	68.8	0	1.3	29.0	0.5	0.3
Facility 6	0	0	0	0	0	52.6	47.4

Table 1. Cont.

Facility ID	<i>Alternaria</i> spp.	<i>Aspergillus</i> spp.	<i>Fusarium</i> spp.	<i>Mucoraceae</i> (family)	<i>Penicillium</i> spp.	Total Yeasts	Other
Facility 7	0.9	2.2	0	1.9	1.9	0.5	92.5
Facility 8	0.3	0.3	0	79.0	2.1	16.2	2.1
Facility 9	0	18.2	0	27.3	36.4	9.1	9.1
Facility 10	0	0	0	0	30.0	55.0	15.0
Facility 11	0	0	0	1.6	93.8	2.7	2.0

Note: relative density was expressed as percentage (%). Facility ID is extruding-expelling facility identification.

3.2. Relationship Between Soybean Expeller Moisture Content and Fungal Biota Load

The average MC of SBE ranged from 4.74% to 14.25% across the 11 extruding-expelling facilities (Figure 2). Despite this variability, the fungal biota load, expressed as CFUg⁻¹ DM, remained relatively constant, ranging from 0 to 4. No significant linear relationship ($p > 0.05$) was found between CFU counts and SBE MC, as evidenced by the low Pearson correlation coefficient ($r = 0.039$).

3.3. Detection and Quantification of Mycotoxins

Only DON and aflatoxins (AFs) were detected in the SBE samples (Table 2). DON and AFB₁ were quantified in 20.0% and 25.7% of samples, respectively, with average concentrations of 215.19 $\mu\text{g kg}^{-1}$ for DON and 41.68 $\mu\text{g kg}^{-1}$ for AFB₁ (Table 2). The detected DON levels ranged from 1.50 $\mu\text{g kg}^{-1}$ (quantification limit) to 2385.20 $\mu\text{g kg}^{-1}$. Among AFs, AFB₁ exhibited the highest concentration, reaching 378 $\mu\text{g kg}^{-1}$. AFG₁ and AFG₂ were quantified in 40% of the samples but at low concentrations, with average values of 0.39 $\mu\text{g kg}^{-1}$ and 0.34 $\mu\text{g kg}^{-1}$, respectively. AFB₂ levels were below the quantification limit. The other analyzed mycotoxins, including NIV, 13 acetyl DON, 15 acetyl DON, ochratoxin A and zearalenone, were not detected.

Table 2. Mycotoxins concentration in soybean expeller samples from different extruded-expelling facilities.

Facility ID	Repetition	DON	AFs			
			B ₁	B ₂	G ₁	G ₂
	LOD ($\mu\text{g kg}^{-1}$)	3	0.2	0.1	0.2	0.1
	LOQ ($\mu\text{g kg}^{-1}$)	10	0.3	0.2	0.3	0.2
Facility 1	1	nd	<LOQ	<LOQ	0.9	1.3
	2	nd	nd	nd	0.5	0.6
	3	nd	nd	nd	nd	nd
	4	nd	nd	nd	0.3	<LOQ
	5	nd	<LOQ	<LOQ	1.0	0.6
Facility 2	1	nd	nd	nd	0.7	0.9
	2	nd	<LOQ	<LOQ	0.6	0.6
	3	nd	nd	nd	0.5	0.6
Facility 3	1	nd	<LOQ	<LOQ	nd	nd
	2	nd	nd	nd	nd	nd
	3	nd	<LOQ	<LOQ	nd	0.3

Table 2. Cont.

Facility ID	Repetition	DON	AFs			
			B ₁	B ₂	G ₁	G ₂
Facility 5	1	nd	0.3	nd	nd	nd
	2	nd	0.3	nd	nd	nd
	3	nd	<LOQ	<LOQ	nd	nd
	4	nd	<LOQ	<LOQ	0.4	0.6
	5	nd	nd	nd	nd	nd
	6	nd	<LOQ	<LOQ	nd	nd
	7	nd	<LOQ	<LOQ	nd	nd
	8	nd	nd	nd	nd	nd
Facility 7	1	nd	<LOQ	<LOQ	0.3	0.5
	2	nd	<LOQ	<LOQ	0.7	0.9
	3	nd	<LOQ	<LOQ	0.7	1.1
Facility 8	1	1038.4	159.0	nd	nd	nd
	2	2385.2	256.5	nd	nd	nd
	3	741.6	127.0	nd	nd	nd
Facility 9	1	nd	<LOQ	<LOQ	0.6	0.5
	2	nd	<LOQ	<LOQ	0.7	0.6
	3	nd	<LOQ	<LOQ	<LOQ	<LOQ
Facility 10	1	nd	nd	nd	nd	nd
	2	nd	<LOQ	<LOQ	3.6	1.7
	3	nd	nd	nd	nd	nd
Facility 11	1	529.2	378.0	nd	nd	nd
	2	1573.8	231.8	nd	nd	nd
	3	706.7	180.4	nd	nd	nd
	4	514.6	122.0	nd	nd	nd
Minimum ($\mu\text{g kg}^{-1}$)		1.50	0.10	0.05	0.10	0.05
1st Quartil ($\mu\text{g kg}^{-1}$)		1.50	0.10	0.05	0.10	0.05
Median ($\mu\text{g kg}^{-1}$)		1.50	0.15	0.05	0.10	0.05
Mean ($\mu\text{g kg}^{-1}$)		215.19	41.68	0.07	0.39	0.34
3rd Quartil ($\mu\text{g kg}^{-1}$)		1.50	0.21	0.10	0.57	0.60
Maximum ($\mu\text{g kg}^{-1}$)		2385.20	378.00	0.10	3.55	1.74
Positives *		7	9	0	14	14
Percentage of positives (%)		20.0	25.7	0	40.0	40.0

Note: DON is deoxynivalenol, AFs is aflatoxins, LOD is limit of detection, LOQ is limit of quantification, nd is not detected, <LOQ is less than limit of quantification, and * is samples with a mycotoxin concentration above the limit of quantification.

Positive linear correlations were found between DON and AFB₁ (0.918), AFG₁ and AFG₂ (0.754), and between DON and AFB₂ (0.736). In contrast, a negative correlation was identified between AFB₁ and AFB₂ (−0.759) (Figure 4). Co-occurrence of two mycotoxins

was observed in 60% of the analyzed samples. The combination of AFG₁ and AFG₂ was found in 40% of the samples, while DON and AFB₁ co-occurred in 20% of the samples.

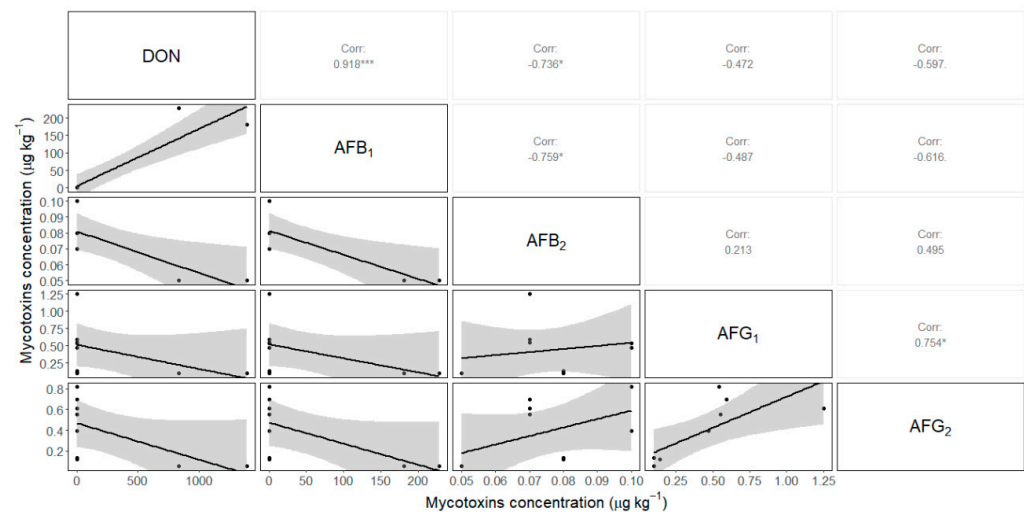

Figure 4. Correlation of mycotoxins concentrations in soybean expeller samples. Panels on the lower left side show the distribution of concentrations (in $\mu\text{g kg}^{-1}$) for each combination of two mycotoxins. Panels in the diagonal show each mycotoxin. Panels on the upper right side show the correlation coefficient for each combination of two mycotoxins. *** $p < 0.001$; * $p < 0.05$.

4. Discussion

4.1. Implications of Fungal Biota Quantification and Identification

The fungal counts reported in this study for SBE were low (ranging from 0 to 4 CFU g^{-1} DM). Currently, no specific regulations define maximum fungal load limits for SBE, and the literature on CFU counts for soybean by-products, such as SBE, is scarce, limiting comparative analyses. Nevertheless, some studies have reported CFU counts for soybeans and soybean meal. For example, Good Manufacturing Practices (GMP 14) recommend a maximum fungal load of 10^4 CFU g^{-1} DM for soybean meal [13]. The CFU counts for SBE in this study were lower than those reported by Ghaemmaghmi et al. [38] (6×10^2 CFU g^{-1} DM) for soybean meal and pellets and by Egbuta et al. [57] (10^6 CFU g^{-1} DM) for processed soybean, using similar CFU count analysis techniques. Therefore, these results indicate that the SBE exhibits good mycological quality, making it suitable for animal consumption.

The low CFU counts found in all SBE samples may be attributed to several factors. Generally, soybeans have lower microbial loads compared to other grains [19,58], which may be related to their chemical composition, particularly their low carbohydrate content [59,60]. Additionally, the processes involved in converting soybeans into SBE likely reduce fungal load [61]. Specially, the extruding-expelling process, which involves simultaneous pressure and temperature treatments, is highly effective in reducing fungal contamination. During extrusion, soybean seeds are processed through a continuous screw system that generates frictional heat (110–150 °C) and high pressure (40 MPa) for a short time (20–30 s) [1,2].

The combined effect of heat and pressure significantly reduce fungal viability [38]. For example, *Fusarium* species, such as *F. graminearum*, do not resist pressures greater than 1.01 MPa, while *A. flavus* and *A. alternata* are inhibited at pressures exceeding 0.505 MPa [62].

Temperature, by itself, also has an effect of microflora. In this study, the temperature recorded in the extruding-expelling processes in the different facilities ranged from 125 °C to 168 °C, significantly exceeding the temperature threshold (83 °C for 7 s) required to inactivate most mesophilic flora [63]. In consequence, the lack of correlation between SBE

MC and normalized CFU in our samples (Figure 2) may be attributed to the effect of high temperature/pressure treatment during the extruding process, which likely reduced the CFU levels.

The most frequently identified fungal genera in SBE samples were *Penicillium*, *Aspergillus*, *Acremonium*, *Cladosporium*, *Eurotium*, *Alternaria*, and *Mucoraceae* (family). These genera are consistent with those previously reported in soybean, although their isolation frequencies varied [13,22,43]. Differences in isolation frequencies may be attributed to variations in the fungal composition of soybean seed [64] and in the conditions of the extruding-expelling process [38], as mentioned above (high temperature and high pressure) [1,2].

The low occurrence of field fungi, such as *Fusarium* and *Alternaria*, could be explained by the low MC of the soybean before processing. Chiotta et al. [65] found that *Fusarium* and *Alternaria* were the most common fungi in recently harvested soybeans, whereas *Aspergillus* and *Penicillium*, which thrive under lower relative humidity, were more prevalent during storage. Barros et al. [40] reported that, during storage, the diversity of fungal genera decreased, with xerophytic genera (*Aspergillus* and *Eurotium*) becoming dominant, while field fungi such as *Fusarium* disappeared.

The hygienic quality of feed and food products must be ensured through proper sanitary conditions. Fungal presence is a recognized indicator of feed hygiene [66]. However, in Argentina, no specific regulations set fungal load limits for feed.

Field observations showed that surveyed extrusion-expelling facilities lack strict sanitation protocols, likely because most produce expeller for feed rather than food. However, facilities processing SBE for food adhere to strict hygiene regulations [67]. Despite this, extrusion effectively reduces fungal contamination, ensuring a microbiologically safe product. This treatment significantly impacts the viability of both somatic and reproductive fungal structures [68,69]. Previous studies [38,66,70] also found that extrusion significantly reduces microbial loads in pellets, aligning with our findings.

4.2. Implications of Soybean Expeller Moisture Content on Fungal Biota Load

The SBE MC showed significant variability across facilities (Figure 2). Some facilities produced by-products with MC below the safe storage MC, while others exceeded it [71], increasing microbiological risks during storage and posing potential safety concerns for feed and food applications. This variability can be attributed to differences in the raw material MC [72] and the conditions of the extruding-expelling process [2]. The SBE MC observed in this study, ranging from 4.74% to 14.25%, aligns with previous reports from Argentine facilities [8,9] and complies with the maximum permitted MC of 14.3% (12.5% w.b.) established by the XIX standard for commercialization in Argentina [10].

These results suggest that, within the tested MC range, fungal proliferation is not only influenced by MC, indicating that additional factors may contribute to the observed variability in fungal biota load among facilities. One possible explanation for the absence of correlation between SBE MC and CFU in our samples might be the high-temperature heat treatment during extruding process, which likely reduces CFU levels by adversely affecting most mesophilic flora, as reported in previous studies [62,63].

4.3. Assessment of Mycotoxins Contamination and Its Implications in Soybean Expeller

No studies reporting mycotoxin levels in SBE were identified. However, the presence of mycotoxins produced by *Fusarium*, *Alternaria*, and *Aspergillus* in soybean seeds and by-products, such as soybean meal, has been documented [25,65,73].

In this study, DON, AFB₁, AFG₁, and AFG₂ were the only mycotoxins quantified in SBE, with detection frequency ranging from 20 to 40% of analyzed samples (Table 2).

Similar mycotoxins were reported by Abia et al. [74] in soybean meal, though with differing occurrence rates. While DON, AFB₁, and AFG₁ were detected, AFB₂, AFG₂, and ochratoxins were absent. Soybeans do not provide a favorable matrix for fungal growth due to their low MC and composition, particularly their high protein/carbohydrate ratio [75]. For this reason, reports of mycotoxins in soybeans are scarce in Argentina, and the detected concentrations are variable.

Low levels of AFs and high levels of DON were detected in soybean samples by Barros et al. [13], while Oviedo et al. [76] identified alternariol and alternariol monomethyl ether. D'Espósito et al. [77] found a higher incidence of AFB₁ (26.66%, 1.44–7.43 µg kg⁻¹) than DON (6.66%, 297–490 µg kg⁻¹) but in soybean samples obtained from silo bags. Compared to SBE samples in this study, AFB₁ incidences were similar, while DON incidences were lower. However, the DON and AFB₁ concentration ranges in SBE were significantly higher (Table 2).

DON is commonly associated with *Fusarium* species, which produce the toxin in the field [78,79]. Reports from Argentina (Córdoba province) confirm the presence of *F. graminearum* and DON during the grain filling and ripening of soybean under high humidity conditions [65,80]. AFs are significant food and feed contaminants produced mainly by *A. flavus* (producing AFB) and *A. parasiticus* (producing both AFB and AFG) [73,81–83]. Only 25–40% of *A. flavus* strains produce AFs [84]. AFB₁, AFG₁, and AFG₂ were quantified in SBE samples at varying concentrations and frequencies (Table 2). AFB₁ was quantified in 25.7% of the SBE samples, with no direct correlation to the low relative density of *Aspergillus* spp. (Table 1). Greco et al. [79] reported AFs in 50% of feed samples containing SBE, with a mean concentration of 2.82 µg kg⁻¹, significantly lower than the mean concentration in this study (10.62 µg kg⁻¹).

The presence of AFG₁ and AFG₂ in SBE samples, not previously reported, suggest contamination of *A. parasiticus*, despite its absence in these samples. AFG concentrations were lower than AFB, indicating *A. flavus* as a likely contributor, given its adaptation to temperate conditions [85].

Mycotoxin contamination does not always correlate with fungal isolation, as toxins can persist after fungal growth ceases due to unfavorable conditions [79]. Industrial processes, such as extrusion, can reduce mycotoxin concentrations [23,86]. However, the effect on each mycotoxin can be different. While DON degrades above 150 °C [44] to 180 °C [87–89], AFs are thermally stable, decomposing only at temperatures from 237 °C (AFG) to 306 °C (AFB) [90]. Consequently, the temperatures reached during the extrusion process likely influenced the observed mycotoxin level in the SBE [91].

Notably, a significant positive correlation was observed between DON and AFB₁, as well as between AFG₁ and AFG₂. Conversely, a significant negative correlation was found between DON and AFB₂ and between AFB₁ and AFB₂ (Figure 4). Co-occurrence of mycotoxins was noted in 60% of SBE samples, with 40% showing AFG₁ and AFG₂, and 20% showing DON and AFB₁ (Table 2). Such co-occurrence aligns with studies indicating frequent multi-mycotoxin contamination in raw materials and feed ingredients [39,52,57,92].

DON and AFs concentration in SBE highlights a potential risk to animal and human health. In 8.6% of the samples, DON level exceeded the European Union threshold of 750 ppb (or 750 µg kg⁻¹) for feed ingredients [93]. For AFs in food and feed ingredients, the accepted levels are 20 and 300 µg kg⁻¹, respectively [94]. In the present study, the mean levels of AFB₁, AFG₁, and AFG₂ were 41.70, 0.39, and 0.38 µg kg⁻¹, respectively. These levels exceeded the specification for food but fell below the specification for feed. However, AFB₁ concentrations also surpassed food safety limits in isolated cases, reaching 378 µg kg⁻¹ (2.9% of samples). Since there are no local regulations in Argentina regarding mycotoxin levels in SBE, the results were compared with international standards and

regulations to assess their safety and quality. This comparison ensures that the findings align with widely recognized guidelines, helping to establish a clearer context for SBE usage in the industry.

Given widespread use of SBE in feed and food formulations, these findings underscore the need for systematic monitoring and adherence to Good Manufacturing Practices (GMP). This study provides clear evidence of raw material (soybean) contamination with mycotoxigenic fungi and their associated mycotoxins, either in the field or during storage. While fungal presence is controlled during the extruding process, as previously explained, mycotoxins are not inactivated during processing. Consequently, the final product may remain contaminated, posing potential health risks to animals consuming SBE directly or as a component of feed formulations. Implementing GMP measures, including drying soybeans, optimizing storage conditions, and regular facility cleaning [95], is critical for minimizing fungal growth and mycotoxin contamination [96–98]. However, the facilities analyzed in this study currently lack mycotoxin control measures, further emphasizing the need for preventive strategies to ensure the safety and quality of soybean by-products for industrial use.

5. Conclusions

The low CFU counts observed in SBE samples suggest that the product is generally of good quality for animal consumption. No correlation was found between the SBE MC and the CFU of fungal biota, probably due to the heat treatment applied during the extruding process. *Penicillium* and *Mucoraceae* (family) were the most frequently isolated fungal genera, among five others. While the concentrations of DON and AFs (B₁, B₂, G₁, and G₂) in the SBE were generally low, some samples exceeded established regulatory limits for food and feed. This suggests that, although thermal treatment during extrusion reduces fungal load, it might not be sufficient to substantially lower mycotoxin concentration. Notably, 60% of SBE samples presented a co-occurrence of at least two mycotoxins.

These findings emphasize the critical importance of monitoring and controlling the SBE MC during storage and conducting regular mycotoxin testing in both whole soybeans and the resulting SBE to ensure safety and quality. Furthermore, the detection of mycotoxins exceeding regulatory thresholds in some SBE samples underscores a potential risk to both animal and human health, emphasizing the need for stringent quality control measures.

Author Contributions: Conceptualization, G.M. and R.E.B.; Data curation, G.M.; Formal analysis, G.M., C.C.C., L.M.C. and M.B.A.; Funding acquisition, L.M.C., P.B. and R.E.B.; Investigation, C.C.C. and M.B.A.; Methodology, G.M. and C.C.C.; Project administration, R.E.B.; Resources, L.M.C. and R.E.B.; Supervision, R.E.B.; Writing—original draft, G.M.; Writing—review and editing, C.C.C., L.M.C., M.B.A., P.B. and R.E.B. All authors have read and agreed to the published version of the manuscript.

Funding: This research was funded by the Instituto Nacional de Tecnología Agropecuaria (INTA) Projects P.E. I119, P.E. I120 and REC I165.

Data Availability Statement: Dataset available on request from the authors.

Acknowledgments: The authors are grateful to Leandro S. Cambareri, Martín Mansilla, and Diego Cristos for their technical support.

Conflicts of Interest: The authors declare no conflicts of interest.

Abbreviations

The following abbreviations are used in this manuscript:

SBE	Soybean expeller
MC	Moisture content
CFU	Colony forming unit
DON	Deoxynivalenol
AF	Aflatoxin
d.b.	Dry basis
w.b.	Wet basis
DM	Dry matter
PDA	Potato dextrose agar
LOD	Limit of detection
LOQ	Limit of quantification
ANOVA	Analysis of variance
SD	Standard deviation
GMP	Good Manufacturing Practices

Appendix A

Table A1. List of analytes determined in the negative or positive ionization mode and parameters for mass-spectrometry.

Analyte Name	Ionization	Precursor Ion (<i>m/z</i>)	Ion Species	Product Ion (<i>m/z</i>)		Collision Cell
				Ion Q	Ion C	
DON	ESI+	297	[M+H] ⁺	249	231	39
Nivalenol	ESI-	311	[M−H] [−]	183	281	39
13 acetyl DON	ESI+	339	[M+H] ⁺	231	213	39
15 acetyl DON	ESI+	339	[M+H] ⁺	321	137	39
Nivalenol	ESI-	371	[M+OAc] [−]	311	281	45
AFB ₁	ESI+	313	[M+H] ⁺	284	241	25
AFB ₂	ESI+	315	[M+H] ⁺	286	259	28
AFG ₁	ESI+	329	[M+H] ⁺	243	200	25
AFG ₂	ESI+	331	[M+H] ⁺	313	245	28

Note: Ion C is qualification product ions, Ion Q is quantification product ions, ESI is electrospray ionization, [M+H]⁺ is protonated adduct, [M−H][−] is deprotonated adduct, and [M+OAc][−] is acetate adduct.

References

- Nelson, A.I.; Wijeratne, W.B.; Yeh, S.W.; Wei, T.M.; Wei, L.S. Dry Extrusion as an Aid to Mechanical Expelling of Oil from Soybeans. *J. Am. Oil Chem. Soc.* **1987**, *64*, 1341–1347. [[CrossRef](#)]
- Bargale, P.C.; Ford, R.J.; Sosulski, F.W.; Wulfsohn, D.; Irudayaraj, J. Mechanical Oil Expression from Extruded Soybean Samples. *J. Am. Oil Chem. Soc.* **1999**, *76*, 223–229.
- Bragachini, M.; Ustarroz, F.; Saavedra, A.E.; Méndez, J.M.; Mathier, D.; Bragachini, M.; Sosa, N.; Alladio, R.M.; Accoroni, C.; Hennung, H. *Evolución Del Sistema Productivo Agropecuario Argentino*; Manfredi: Córdoba, Argentina, 2017.
- Medic, J.; Atkinson, C.; Hurburgh, C.R. Current Knowledge in Soybean Composition. *J. Am. Oil Chem. Soc.* **2014**, *91*, 363–384. [[CrossRef](#)]
- Papier, K.; Tong, T.Y.; Appleby, P.N.; Bradbury, K.E.; Fensom, G.K.; Knuppel, A.; Perez-Cornago, A.; Schmidt, J.A.; Travis, R.C.; Key, T.J. Comparison of Major Protein-Source Foods and Other Food Groups in Meat-Eaters and Non-Meat-Eaters in the Epic-Oxford Cohort. *Nutrients* **2019**, *11*, 824. [[CrossRef](#)]
- SAGyP. Molienda de Granos Oleaginosos, Producción de Aceites, Pellets y Expellers. Available online: [https://www.magyp.gob.ar/sitio/areas/ss_mercados_agropecuarios/areas/granos/_archivos/000058_Estad%C3%ADsticas/000032_Evolucion%20de%20la%20Molienda%20\(Cereales%20y%20Oleaginosas\)/000002_Evoluci%C3%B3n%20de%20la%20Molienda%20Mensual%20-%20Oleaginosas/000002_Evoluci%C3%B3n%20de%20la%20Molienda%20Mensual%20-%20Oleaginosas.php](https://www.magyp.gob.ar/sitio/areas/ss_mercados_agropecuarios/areas/granos/_archivos/000058_Estad%C3%ADsticas/000032_Evolucion%20de%20la%20Molienda%20(Cereales%20y%20Oleaginosas)/000002_Evoluci%C3%B3n%20de%20la%20Molienda%20Mensual%20-%20Oleaginosas/000002_Evoluci%C3%B3n%20de%20la%20Molienda%20Mensual%20-%20Oleaginosas.php) (accessed on 25 September 2024).

7. RUCA-MAGyP. Registro Único de La Cadena Agroalimentaria. Available online: <https://ruca.magyp.gob.ar/padron/> (accessed on 24 November 2023).
8. Maciel, G.; Wagner, J.R.; Juan, N.A.; San Martino, S.; Bartosik, R.E. Assessment of the Main Sources of Variability of Soybean (Glycine Max) Expeller Composition and Quality: A Field Study. *Agric. Eng. Int. CIGR J.* **2020**, *22*, 211–220.
9. Juan, N.A.; Massigogue, J.I.; Errasquin, L.; Méndez, J.M.; Ochandio, D.C.; Saavedra, A.E.; Paolilli, M.C.; Alladio, R.M.; Accoroni, C.; Behr, E.F. *Calidad de la Soja Procesada y del Expeller Producido por la Industria de Extrusado-Prensado en Argentina*; Ediciones INTA: Buenos Aires, Argentina, 2015.
10. SAGPyA. *Resolución SAGPyA N° 317/99. Norma XIX: Subproductos de Oleaginosos*; SAGPyA: Buenos Aires, Argentina, 1999; p. 10.
11. Kumar, C.; Karim, M.A.; Joardder, M.U.H. Intermittent Drying of Food Products: A Critical Review. *J. Food Eng.* **2014**, *121*, 48–57. [[CrossRef](#)]
12. Smith, J.E.; Solomons, G.; Lewis, C.; Anderson, J.G. Role of Mycotoxins in Human and Animal Nutrition and Health. *Nat. Toxins* **1995**, *3*, 187–192. [[CrossRef](#)]
13. Barros, G.G.; Oviedo, M.S.; Ramirez, M.L.; Chulze, S.N. Safety Aspect in Soybean Food and Feed Chains: Fungal and Mycotoxins Contamination. In *Soybean—Biochemistry, Chemistry and Physiology*; IntechOpen: London, UK, 2011; pp. 7–20.
14. Fleurat-Lessard, F. Integrated Management of the Risks of Stored Grain Spoilage by Seedborne Fungi and Contamination by Storage Mould Mycotoxins—An Update. *J. Stored Prod. Res.* **2017**, *71*, 22–40. [[CrossRef](#)]
15. Magan, N.; Sanchis, V.; Aldred, D. The Role of Spoilage Fungi in Seed Deterioration. In *Fungal Biotechnology in Agricultural, Food and Environmental Applications*; CRC Press: Boca Raton, FL, USA, 2004; Chapter 28; pp. 311–323.
16. Sirohi, R.; Tarafdar, A.; Kumar Gaur, V.; Singh, S.; Sindhu, R.; Rajasekharan, R.; Madhavan, A.; Binod, P.; Kumar, S.; Pandey, A. Technologies for Disinfection of Food Grains: Advances and Way Forward. *Food Res. Int.* **2021**, *145*, 110396. [[CrossRef](#)]
17. Suleiman, R.A.; Rosentrater, K.A.; Bern, C.J. Effects of Deterioration Parameters on Storage of Maize. In Proceedings of the ASABE Annual International Meeting, Kansas City, MO, USA, 21–24 July 2013; p. 51.
18. Castellari, C.C.; Cendoya, M.G.; Marcos Valle, F.J.; Barrera, V.; Pacin, A.M. Factores Extrínsecos e Intrínsecos Asociados a Poblaciones Fúngicas Micotoxigénicas de Granos de Maíz (*Zea mays* L.) Almacenados En Silos Bolsa En Argentina. *Rev. Argent. Microbiol.* **2015**, *47*, 350–359. [[CrossRef](#)]
19. Garcia, L.P.; Savi, G.D.; Santos, K.; Scussel, V.M. Fumonisin and Fungi in Dry Soybeans (*Glycine max* L.) for Human Consumption. *Food Addit. Contam. Part B Surveill.* **2016**, *9*, 79–84. [[CrossRef](#)] [[PubMed](#)]
20. Gomes, D.P.; Kronka, A.Z.; Barrozo, L.M.; Silva, R.P.D.; Souza, A.L.; Silva, B.M.S.e.; Panizzi, R.D.C. Efeito Da Colhedora, Velocidade e Ponto de Coleta Na Contaminação de Sementes de Soja Por Fungos. *Rev. Bras. Sementes* **2009**, *31*, 160–166. [[CrossRef](#)]
21. Njobeh, P.B.; Dutton, M.F.; Koch, S.H.; Chuturgoon, A.; Stoev, S.; Seifert, K. Contamination with Storage Fungi of Human Food from Cameroon. *Int. J. Food Microbiol.* **2009**, *135*, 193–198. [[CrossRef](#)] [[PubMed](#)]
22. Zelaya, M.J.; González, H.H.L.; Resnik, S.L.; Pacin, A.M. Mycobiota and Potential Mycotoxin Contamination of Soybean RR in Different Production Areas in Argentina. *Int. Res. J. Plant Sci.* **2013**, *4*, 133–143.
23. Bullerman, L.B.; Bianchini, A. Good Food-Processing Techniques: Stability of Mycotoxins in Processed Maize-Based Foods. In *Mycotoxin Reduction in Grain Chains*; John Wiley & Sons: Hoboken, NJ, USA, 2014; pp. 89–100.
24. Kumera, N.; Mohammed, A. Mycotoxin Occurrence in Grains and the Role of Postharvest Management as a Mitigation Strategies. A Review. *Food Cont.* **2017**, *78*, 412–425.
25. Schollenberger, M.; Müller, H.M.; Rühle, M.; Suchy, S.; Plank, S.; Drochner, W. Natural Occurrence of 16 Fusarium Toxins in Grains and Feedstuffs of Plant Origin from Germany. *Mycopathologia* **2006**, *161*, 43–52. [[CrossRef](#)]
26. Waskiewicz, A. Natural Occurrence of Mycotoxins in Food. *Encycl. Food Microbiol.* **2014**, *2*, 880–886.
27. Mishra, S.; Ansari, K.M.; Dwivedi, P.D.; Pandey, H.P.; Das, M. Occurrence of Deoxynivalenol in Cereals and Exposure Risk Assessment in Indian Population. *Food Control* **2013**, *30*, 549–555. [[CrossRef](#)]
28. WHO. Safety Evaluation of Certain Mycotoxins in Food. In *FAO Food and Nutrition Paper 74*; WHO Food Additives Series 47; WHO: Genève, Switzerland, 2001; pp. 419–455.
29. Rotter, B.A.; Prelusky, D.B.; Pestka, J.J. Invited Review: Toxicology of deoxynivalenol (vomitoxin). *J. Toxicol. Environ. Health* **1996**, *48*, 1–34. [[CrossRef](#)]
30. International Agency for Research on Cancer. Monographs on the Evaluation of Carcinogenic Risk of Chemicals to Humans: Some Naturally Occurring Substances: Food Items and Constituents, Heterocyclic Aromatic Amines and Mycotoxins. *Hum. Papillomaviruses* **1993**, *56*, 609.
31. Amuzie, C.J.; Pestka, J.J. Suppression of Insulin-Like Growth Factor Acid-Labile Subunit Expression—A Novel Mechanism for Deoxynivalenol-Induced Growth Retardation. *Toxicol. Sci.* **2010**, *3*, 412–421.
32. Ellis, W.O.; Smith, J.P.; Simpson, B.K.; Oldham, J.H.; Scott, P.M. Aflatoxins in Food: Occurrence, Biosynthesis, Effects on Organisms, Detection, and Methods of Control. *Crit. Rev. Food Sci. Nutr.* **1991**, *30*, 403–439. [[CrossRef](#)] [[PubMed](#)]
33. Bennett, J.; Klich, M. Mycotoxins: Clinical Microbiology Reviews. *ASM* **2003**, *16*, 497–516.

34. International Agency for Research on Cancer. *Monographs on the Evaluation of Carcinogenic Risk of Chemicals to Humans: Some Traditionally Herbal Medicines, Some Mycotoxins, Naphthalene and Styrene*; WHO: Genève, Switzerland, 2002; Volume 82, p. 601.
35. Arapcheska, M.; Jovanovska, V.; Jankuloski, Z.; Hajruali–Musliu, Z.; Uzunov, R. Impact of Aflatoxins on Animal and Human Health. *Int. J. Innov. Sci. Eng. Technol.* **2015**, *2*, 156–161.
36. Joint FAO/WHO Expert Committee on Food Additives. *Safety Evaluation of Certain Food Additives and Contaminants*; Joint FAO/WHO Expert Committee on Food Additives AFLA: Geneva, Switzerland, 1998.
37. Bhat, R.; Reddy, K.R.N. Challenges and Issues Concerning Mycotoxins Contamination in Oil Seeds and Their Edible Oils: Updates from Last Decade. *Food Chem.* **2017**, *215*, 425–437. [[CrossRef](#)]
38. Ghaemmaghami, S.S.; Modirsaneii, M.; Khosravi, A.R.; Razzaghi-Abyaneh, M. Study on Mycoflora of Poultry Feed Ingredients and Finished Feed in Iran. *Iran J. Microbiol.* **2016**, *8*, 47–54.
39. Gutleb, A.C.; Caloni, F.; Giraud, F.; Cortinovis, C.; Pizzo, F.; Hoffmann, L.; Bohn, T.; Pasquali, M. Detection of Multiple Mycotoxin Occurrences in Soy Animal Feed by Traditional Mycological Identification Combined with Molecular Species Identification. *Toxicol. Rep.* **2015**, *2*, 275–279. [[CrossRef](#)]
40. Barros, G.; Gacía, D.; Oviedo, M.S.; Ramirez, M.L.; Torres, A.; Chulze, S. Influencia Del Almacenamiento Sobre La Micoflora de Soja Utilizada Para La Producción de Harina. In *VI Congreso Latinoamericano de Micología*; Asociación Latinoamericana de Micología: Mar del Plata, Argentina; Buenos Aires, Argentina, 2008.
41. Boca, R.T.; Pacin, A.M.; González, H.H.L.; Resnik, S.L.; Souza, J.C. Soja y Mocotoxinas: Flora Fúngica—Variedades—Prácticas Agronómicas. *Aceites Grasas* **2003**, *Tomo XIII*, 510–515.
42. Broggi, L.E.; Pacin, A.M.; Gasparovie, A.; Sacchi, C.; Rothermel, A.; Gallay, A.; Resnik, S. Natural Occurrence of Aflatoxins, Deoxynivalenol, Fumonisin and Zearalenone in Maize from Entre Ríos Province, Argentina. *Mycotoxin Res.* **2007**, *23*, 59–64. [[CrossRef](#)]
43. Garrido, C.E.; González, H.L.; Salas, M.P.; Resnik, S.L.; Pacin, A.M. Mycoflora and Mycotoxin Contamination of Roundup Ready Soybean Harvested in the Pampean Region, Argentina. *Mycotoxin Res.* **2013**, *29*, 147–157.
44. Gimeno, A.; Martins, M.L. *Micotoxinas y Micotoxicosis en Animales y Humanos*, 3rd ed.; Special Nutrients, Inc.: Miami, FL, USA, 2011.
45. *ASAE Standard—S352.2; Moisture Measurement—Unground Grain and Seeds*. ASAE: St. Joseph, MI, USA, 2003; p. 593.
46. Atlas, R.M. *Handbook of Microbiological Media*, 3rd ed.; CRC Press: Boca Raton, FL, USA, 2004; ISBN 978-0-429-12903-2.
47. Pitt, J.I.; Hocking, A.D. *Fungi and Food Spoilage*; Springer International Publishing: Berlin/Heidelberg, Germany, 2009; ISBN 978-0-387-92206-5.
48. Nelson, P.E.; Toussoun, T.A.; Marasas, W.F.O. *Fusarium Species. An Illustrated Manual of Identification*; The Pennsylvania State University Press: University Park, PA, USA, 1983.
49. Barbosa, T.S.; Pereyra, C.M.; Soleiro, C.A.; Dias, E.O.; Oliveira, A.A.; Keller, K.M.; Silva, P.P.O.; Cavaglieri, L.R.; Rosa, C.A.R. Mycobiota and Mycotoxins Present in Finished Fish Feeds from Farms in the Rio de Janeiro State, Brazil. *Int. Aquat. Res.* **2013**, *5*, 3. [[CrossRef](#)]
50. Zelaya, M.J. *Estudio de La Micoflora Contaminante Del Germoplasma de Soja En Argentina*; Universidad de Buenos Aires: Buenos Aires, Argentina, 2006.
51. Castañares, E.; Martínez, M.; Cristos, D.; Rojas, D.; Lara, B.; Stenglein, S.; Dinolfo, M.I. Fusarium Species and Mycotoxin Contamination in Maize in Buenos Aires Province, Argentina. *Eur. J. Plant Pathol.* **2019**, *155*, 1265–1275. [[CrossRef](#)]
52. Calori-Domingues, M.A.; Iwahashi, P.M.R.; Ponce, G.H.; Gloria, E.M.d.; Dias, C.T.d.S.; Button, D.C.; De Camargo, A.C. Aflatoxin B1 and Zearalenone in Soybeans: Occurrence and Distribution in Whole and Defective Kernels. *Food Addit. Contam. Part B Surveill.* **2018**, *11*, 273–280. [[CrossRef](#)] [[PubMed](#)]
53. Schothorst, R.; van Egmond, H.P. Report from SCOOP Task 3.2.10 “Collection of Occurrence Data of Fusarium Toxins in Food and Assessment of Dietary Intake by the Population of EU Member States” Subtask: Trichothecenes. *Tox. Lett.* **2004**, *153*, 133–143. [[CrossRef](#)] [[PubMed](#)]
54. R Core Team. *R: A Language and Environment for Statistical Computing*; R Core Team: Vienna, Austria, 2023; Available online: <https://www.r-project.org/> (accessed on 21 April 2023).
55. Kruskal, W.H.; Wallis, W.A. Use of Ranks in One-Criterion Variance Analysis. *J. Am. Stat. Assoc.* **1952**, *47*, 583–621. [[CrossRef](#)]
56. Dunn, J.T. Multiple Comparisons Using Rank Sums. *Technometrics* **1964**, *6*, 241–252. [[CrossRef](#)]
57. Egbuta, M.A.; Mwanza, M.; Phoku, J.Z.; Chilaka, C.A.; Dutton, M.F. Comparative Analysis of Mycotoxigenic Fungi and Mycotoxins Contaminating Soya Bean Seeds and Processed Soya Bean from Nigerian Markets. *Adv. Microbiol.* **2016**, *06*, 1130–1139. [[CrossRef](#)]
58. Roigé, M.B.; Aranguren, S.M.; Riccio, M.B.; Pereyra, S.; Soraci, A.L.; Tapia, M.O. Mycobiota and Mycotoxins in Fermented Feed, Wheat Grains and Corn Grains in Southeastern Buenos Aires Province, Argentina. *Rev. Iberoam. Micol.* **2009**, *26*, 233–237. [[CrossRef](#)]

59. Ochandio, D.; Bartosik, R.; Gastón, A.; Abalone, R.; Arias Barreto, A.; Yommi, A. Modelling Respiration Rate of Soybean Seeds (*Glycine max* (L.)) in Hermetic Storage. *J. Stored Prod. Res.* **2017**, *74*, 36–45. [[CrossRef](#)]
60. Piotrowska, M.; Śliżewska, K.; Biernasiak, J. Chapter 8: Mycotoxins in Cereal and Soybean-Based Food and Feed. In *Soybean—Pest Resistance*; El-Shemy, H.A., Ed.; InTech: Rijeka, Croatia, 2013; pp. 185–230; ISBN 978-953-51-0978-5.
61. Coradi, P.C.; De Lacerda Filho, A.F.; Paes Chaves, J.B.; De Castro Melo, E. Effects of the Feed Processing in the Reduction of the Microbiological Contamination on the Final Product. *Rev. Bras. Prod. Agroindustriais* **2013**, *15*, 81–92.
62. Buerman, E.C.; Worobo, R.W.; Padilla-Zakour, O.I. High Pressure Processing of Spoilage Fungi as Affected by Water Activity in a Diluted Apple Juice Concentrate. *Food Cont.* **2019**, *8*, 106779. [[CrossRef](#)]
63. Okelo, P.O.; Wagner, D.D.; Carr, L.E.; Wheaton, F.W.; Douglass, L.W.; Joseph, S.W. Optimization of Extrusion Conditions for Elimination of Mesophilic Bacteria during Thermal Processing of Animal Feed Mash. *Anim. Feed Sci. Technol.* **2006**, *129*, 116–137. [[CrossRef](#)]
64. Zelaya, M.J.; González, H.L.; Resnik, S.L.; Martínez, M.J. Microflora Contaminante En Soja Cosechada En La Principal Zona de Producción de La República Argentina. In Proceedings of the X Congreso Argentino de Ciencia y Tecnología de Alimentos. Primer Simposio Internacional de Nuevas Tecnologías, Mar del Plata, Argentina, 18–20 May 2005; p. 318.
65. Chiotta, M.L.; Fumero, M.V.; Cendoya, E.; Palazzini, J.M.; Alaniz-Zanon, M.S.; Ramirez, M.L.; Chulze, S.N. Toxicogenic Fungal Species and Natural Occurrence of Mycotoxins in Crops Harvested in Argentina. *Rev. Argent. Microbiol.* **2020**, *52*, 339–347. [[CrossRef](#)] [[PubMed](#)]
66. Del Pilar Monge, M.; Magnoli, C.E.; Chiacchiera, S.M. Survey of *Aspergillus* and *Fusarium* Species and Their Mycotoxins in Raw Materials and Poultry Feeds from Córdoba, Argentina. *Mycotoxin Res.* **2012**, *28*, 111–122. [[CrossRef](#)]
67. CAA. *Código Alimentario Argentino Capítulo II: Condiciones Generales de Las Fábricas y Comercios de Alimentos*; CAA: Buenos Aires, Argentina, 2023; p. 78.
68. Jay, J.M.; Loessner, M.J.; Golden, D.A.; García de Fernando Minguillón, G.D. *Microbiología Moderna de Los Alimentos*; Acribia: Zaragoza, España, 2009; ISBN 84-200-1125-8.
69. Hong, T.D.; Ellis, R.H.; Moore, D. Development of a Model to Predict the Effect of Temperature and Moisture on Fungal Spore Longevity. *Ann. Bot.* **1997**, *79*, 121–128. [[CrossRef](#)]
70. Dalcerio, A.; Magnoli, C.; Luna, M.; Ancasi, G.; Reynoso, M.M.; Chiacchiera, S.; Miazzo, R.; Palacio, G. Mycoflora and Naturally Occurring Mycotoxins in Poultry Feeds in Argentina. *Mycopathologia* **1998**, *141*, 37–43. [[CrossRef](#)]
71. Maciel, G.; de la Torre, D.A.; Cardoso, L.M.; Cendoya, M.G.; Wagner, J.R.; Bartosik, R.E. Determination of Safe Storage Moisture Content of Soybean Expeller by Means of Sorption Isotherms and Product Respiration. *J. Stored Prod. Res.* **2020**, *86*, 101567. [[CrossRef](#)]
72. Zhu, S.; Riaz, M.N.; Lusas, E.W. Effect of Different Extrusion Temperatures and Moisture Content on Lipoxigenase Inactivation and Protein Solubility in Soybeans. *J. Agric. Food Chem.* **1996**, *44*, 3315–3318. [[CrossRef](#)]
73. Pacin, A. ¿Existe UN Diagnóstico Sobre Micotoxinas en Soja en Argentina? In Proceedings of the Workshop Calidad de la Producción y Granos con Valor Agregado, Mercosoja, Rosario-Santa Fe, Argentina, 2006; pp. 285–287.
74. Abia, W.A.; Warth, B.; Sulyok, M.; Krska, R.; Tchana, A.N.; Njobeh, P.B.; Dutton, M.F.; Moundipa, P.F. Determination of Multi-Mycotoxin Occurrence in Cereals, Nuts and Their Products in Cameroon by Liquid Chromatography Tandem Mass Spectrometry (LC-MS/MS). *Food Control* **2013**, *31*, 438–453. [[CrossRef](#)]
75. Pereira, C.S.; Cunha, S.C.; Fernandes, J.O. Prevalent Mycotoxins in Animal Feed: Occurrence and Analytical Methods. *Toxins* **2019**, *11*, 290. [[CrossRef](#)]
76. Oviedo, M.S.; Ramirez, M.L.; Barros, G.G.; Chulze, S.N. Influence of Water Activity and Temperature on Growth and Mycotoxin Production by *Alternaria Alternata* on Irradiated Soya Beans. *Int. J. Food Microbiol.* **2011**, *149*, 127–132. [[CrossRef](#)] [[PubMed](#)]
77. D'Espósito, R.E.; Jimeno, M.A.; Metz, M.P.; Cardozo, G. Aislamiento Micotoxinas En Silos Bolsa Con Granos de Maíz y Soja. In Proceedings of the I Jornada Nacional de Agroalimentos y Sustentabilidad, Córdoba, Argentina, 7 June 2019; pp. 1–3.
78. Joint FAO/WHO Expert Committee on Food Additives. *Summary and Conclusions. Seventy-Second Meeting of the Joint FAO/WHO Expert Committee on Food Additives (JECFA/72/SC)*; WHO: Geneva, Switzerland, 2010; p. 16.
79. Greco, M.; Pardo, A.; Pose, G. Mycotoxigenic Fungi and Natural Co-Occurrence of Mycotoxins in Rainbow Trout (*Oncorhynchus Mykiss*) Feeds. *Toxins* **2015**, *7*, 4595–4609. [[CrossRef](#)] [[PubMed](#)]
80. Barros, G.; Alaniz Zanon, M.S.; Abod, A.; Oviedo, M.S.; Ramirez, M.L.; Reynoso, M.M.; Torres, A.; Chulze, S. Natural Deoxynivalenol Occurrence and Genotype and Chemotype Determination of a Field Population of the *Fusarium Graminearum* Complex Associated with Soybean in Argentina. *Food Addit. Contam. Part A Chem. Anal. Control. Expo. Risk Assess.* **2012**, *29*, 293–303. [[CrossRef](#)] [[PubMed](#)]
81. Ahammed, S.K.; Anandam, R.J.; Prasad Babu, G.; Munikrishnaiah, M.; Gopal, K. Studies on Seed Mycoflora of Soybean and Its Effect on Seed and Seedling Quality Characters. *Legume Res.* **2006**, *29*, 186–190.
82. EFSA. *Aflatoxins (Sum of B1, B2, G1, G2) in Cereals and Cereal-derived Food Products*; EFSA: Parma, Italy, 2013; p. 11.

83. Vaamonde, G.; Degrossi, C.; Comerio, R.; Fernandez Pinto, Y.V. Provincia de cordoba (argentina): Características diferenciales y capacidad aflatoxicogénica. *Bol. Soc. Argent. Bot.* **1995**, *30*, 191–198.
84. Abarca, M.L.; Bragulat, M.R.; Castella, G.; Cabanes, F.J. *Mycoflora and Aflatoxin-Producing Strains in Animal Mixed Feeds*; Elsevier: Amsterdam, The Netherlands, 1994; Volume 57, pp. 256–258.
85. Gourama, H.; Bullerman, L.B. *Aspergillus Flavus and Aspergillus Parasiticus: Aflatoxigenic Fungi of Concern in Foods and Feeds T: A Review. J. Food Prot.* **1995**, *58*, 1395–1404.
86. Ricca, A.P. Gestión de La Inocuidad En Los Granos Para Potenciar Su Valor Agregado. In *Integración Asociativa del Campo a la Gondola*; Ediciones, I., Ed.; 1° Congreso de Valor Agregado en Origen; Manfredi: Córdoba, Argentina, 2012; pp. 225–229.
87. Ehling, G.; Cockburn, A.; Snowdon, P.; Buschhaus, H. The Significance of the Fusarium Toxin Deoxynivalenol (DON) for Human and Animal Health. *Cereal Res. Commun.* **1997**, *25*, 443–447.
88. Hazel, C.M.; Patel, S. Influence of Processing on Trichothecene Levels. *Toxicol. Lett.* **2004**, *153*, 51–59. [[CrossRef](#)]
89. Lori, G.A.; Rizzo, I. Deoxinivalenol. In *Micotoxinas en Alimentos*; Editorial Díaz de Santos, S.A.: Madrid, Spain, 2007; pp. 269–292; ISBN 978-84-9969-962-2.
90. Jalili, M. A Review on Aflatoxins Reduction in Food. *Iran. J. Health Saf. Environ.* **2015**, *3*, 445–459.
91. Cazzaniga, D.; Basílico, J.C.; González, R.J.; Torres, R.L.; De Greef, D.M. Mycotoxins Inactivation by Extrusion Cooking of Corn Flour. *Lett. Appl. Microbiol.* **2001**, *33*, 144–147. [[CrossRef](#)]
92. Binder, E.M.; Tan, L.M.; Chin, L.J.; Handl, J.; Richard, J. Worldwide Occurrence of Mycotoxins in Commodities, Feeds and Feed Ingredients. *Anim. Feed Sci. Technol.* **2007**, *137*, 265–282. [[CrossRef](#)]
93. Regulation EC. *Regulation (EC) N° 1881/2006. Setting Maximum Levels for Certain Contaminants in Foodstuffs*; EU: Brussels, Belgium, 2006; Volume L 364.
94. FDA. *Guidance for Industry: Action Levels for Poisonous or Deleterious Substances in Human Food and Animal*; FDA: Silver Spring, MD, USA, 2000.
95. Abadía, B.; Bartosik, R. *Manual de Buenas Prácticas En Poscosecha de Granos: Hacia El Agregado de Valor En Origen de La Producción Primaria*; Bernadette, A., Bartosik, R., Eds.; Ediciones INTA: Buenos Aires, Argentina, 2013; ISBN 978-987-679-264-6.
96. Lusas, E.W. Soybean Processing and Utilization. In *Soybeans: Improvement, Production, and Uses*; American Society of Agronomy, Crop Science Society of America, Soil Science Society of America: Madison, WI, USA, 2004; Volume 16, pp. 949–1045.
97. Magan, N.; Aldred, D.; Baxter, E.S. Good Postharvest Storage Practices for Wheat Grain. In *Mycotoxin Reduction in Grain Chains*; John Wiley & Sons: Hoboken, NJ, USA, 2014.
98. Toomer, O.T.; Oviedo, E.O.; Ali, M.; Patino, D.; Joseph, M.; Frinsko, M.; Vu, T.; Maharjan, P.; Fallen, B.; Mian, R. Current Agronomic Practices, Harvest & Post-Harvest Processing of Soybeans (*Glycine max*)—A Review. *Agronomy* **2023**, *13*, 427. [[CrossRef](#)]

Disclaimer/Publisher’s Note: The statements, opinions and data contained in all publications are solely those of the individual author(s) and contributor(s) and not of MDPI and/or the editor(s). MDPI and/or the editor(s) disclaim responsibility for any injury to people or property resulting from any ideas, methods, instructions or products referred to in the content.