

A state-of-the-art survey on IRS-NOMA for integrated sensing and communication

Original

A state-of-the-art survey on IRS-NOMA for integrated sensing and communication / Nath Sur, Samarendra; Kumar Singh, Arun; Tran, Huu Q.; Vishwakarma, Pradeep; Imoize, AGBOTINAME LUCKY; Li, Chun-Ta. - In: IEEE ACCESS. - ISSN 2169-3536. - ELETTRONICO. - 12:(2024), pp. 186087-186123. [10.1109/ACCESS.2024.3512998]

Availability:

This version is available at: 11583/2998095 since: 2025-03-05T15:28:46Z

Publisher:

Institute of Electrical and Electronics Engineers

Published

DOI:10.1109/ACCESS.2024.3512998

Terms of use:

This article is made available under terms and conditions as specified in the corresponding bibliographic description in the repository

Publisher copyright

(Article begins on next page)

Received 10 November 2024, accepted 2 December 2024, date of publication 9 December 2024, date of current version 18 December 2024.

Digital Object Identifier 10.1109/ACCESS.2024.3512998

SURVEY

A State-of-the-Art Survey on IRS-NOMA for Integrated Sensing and Communication

SAMARENDRA NATH SUR¹, (Senior Member, IEEE),
ARUN KUMAR SINGH¹, (Member, IEEE), **HUU Q. TRAN²**, (Member, IEEE),
PRADEEP VISHWAKARMA¹, **AGBOTINAME LUCKY IMOIZE^{3,4}**, (Senior Member, IEEE),
AND CHUN-TA LI⁵, (Senior Member, IEEE)

¹Department of Electronics and Communication Engineering, Sikkim Manipal Institute of Technology, Sikkim Manipal University, Gangtok, Sikkim 737136, India

²Faculty of Electronics Technology (FET), Industrial University of Ho Chi Minh City, Ho Chi Minh City 70000, Vietnam

³Consorzio Nazionale Interuniversitario per le Telecomunicazioni (CNIT), 43124 Parma, Italy

⁴Department of Electronics and Telecommunications (DET), Politecnico di Torino, 10129 Turin, Italy

⁵Bachelor's Program of Artificial Intelligence and Information Security, Graduate Institute of Applied Science and Engineering, Fu Jen Catholic University, New Taipei City 24205, Taiwan

Corresponding author: Chun-Ta Li (157278@mail.fju.edu.tw)

The work of Chun-Ta Li was supported in part by the National Science and Technology Council in Taiwan under Contract NSTC 113-2410-H-030-077-MY2, and in part by Fu Jen Catholic University in Taiwan under Contract A0112014. The work of Agbotiname Lucky Imoize was supported by European Commission through Horizon Europe (HE)-Marie Skłodowska-Curie Actions (MSCA)-Doctoral Networks (DN)-INTEGRATE Project under Grant 101072924.

ABSTRACT In recent years, the rapid advancements in wireless communication technologies have necessitated more efficient and integrated systems. An emerging paradigm addressing this need is the integration of Intelligent Reflecting Surfaces (IRS) with Non-Orthogonal Multiple Access (NOMA) for Integrated Sensing and Communication (ISAC). This paper offers a comprehensive survey of the state-of-the-art IRS-NOMA technologies, emphasizing their potential to enhance ISAC systems. We examine the fundamental principles of IRS and NOMA, investigating how their combined integration can markedly improve spectral and energy efficiencies, system capacity, and overall performance. The survey methodically categorizes and reviews recent research contributions, highlighting key innovations, design methodologies, advancements in the sophisticated algorithms, and performance metrics. Furthermore, we address the practical challenges and implementation issues associated with IRS-NOMA in ISAC, such as hardware limitations, signal processing complexities, and security concerns. Additionally, we outline open research directions and future prospects, aiming to stimulate further advancements in this promising field. Also, we highlight the interplay between the IRS assisted ISAC NOMA with the other emerging technologies towards the realization of 6G. Lastly, we present and summarize the lessons learned from this study. This survey serves as an invaluable resource for researchers and practitioners interested in understanding and advancing IRS-NOMA for next-generation integrated sensing and communication systems.

INDEX TERMS 6G, ISAC, IRS, NOMA, optimization, sensing, wireless communication.

I. INTRODUCTION

The introduction of fifth-generation (5G) wireless communication networks has ushered in a new era of connectivity, marked by extraordinary data speeds, ultra-reliable low-latency communications (URLLC) [1], [2], and massive

The associate editor coordinating the review of this manuscript and approving it for publication was Walid AL-Hussaibi¹.

machine-type communications (mMTC) [3]. As we advance toward sixth-generation (6G) networks, the integration of cutting-edge technologies becomes essential to satisfy the increasing demand for more efficient, dependable, and versatile communication systems. Among the many innovative technologies, Integrated Sensing and Communication (ISAC), Non-Orthogonal Multiple Access (NOMA), and Intelligent Reflecting Surfaces (IRS) are prominent as key

enablers for the next generation of wireless networks. ISAC is a revolutionary concept that combines the functions of wireless communication and radio sensing into a single framework. This dual capability enables the concurrent transmission of data and the gathering of environmental information, which can be utilized for various applications, including autonomous driving, smart cities, and industrial automation [4]. The integration of sensing and communication promotes the more efficient use of spectral resources, lowers hardware costs, and enables new services that were previously unattainable with traditional communication systems. ISAC systems are designed to harness the synergy between communication and sensing, thereby improving overall performance and unlocking new opportunities for innovation in wireless networks [5]. In [6], the authors introduced an innovative online learning strategy using the multi-armed bandit (MAB) framework to effectively manage inter-functionality interference (IFI) in a ISAC-NOMA environment. Their approach addresses interference by jointly optimizing the communication unit (CU)-radar target (RT) pairing, power allocation (PA) at both the base station (BS) and communication units (CUs), and the design of the receiver beamformer. The proposed optimization problem carefully balances the intricate relationship between the communication rates of CUs and the radar estimation information rate (REIR) of RTs in the uplink scenario.

NOMA is a multiple access technique designed to enhance the spectral efficiency of wireless communication systems by enabling multiple users to share the same frequency and time resources. Unlike traditional orthogonal multiple access schemes such as Time Division Multiple Access (TDMA) or Frequency Division Multiple Access (FDMA), NOMA differentiates users based on their power levels or code sequences [7]. By superimposing signals from different users and using advanced signal processing techniques at the receiver, NOMA can significantly boost network capacity and support a larger number of simultaneous users [8], [9], [10], [11], [12], [13]. The inherent ability of NOMA to deliver high spectral efficiency, low latency, and massive connectivity makes it a promising candidate for 6G networks [14]. IRS is an emerging technology that uses programmable metasurfaces to control the propagation environment of electromagnetic waves. By dynamically adjusting the phase, amplitude, and polarization of incident signals, IRS can create favorable propagation conditions, thereby enhancing the performance of wireless communication systems [15], [16]. IRS can be deployed on building facades, walls and other structures to mitigate signal blockages, extend coverage, and improve signal quality in challenging environments [17]. The reconfigurability and low power consumption of IRS make it a cost-effective solution for boosting the efficiency and reliability of wireless networks [18]. The integration of ISAC, NOMA, and IRS represents a powerful synergy that can revolutionize the landscape of wireless communication. By combining the sensing capabilities of ISAC, the spectral

efficiency of NOMA, and the environmental control offered by IRS, it is possible to develop highly efficient and intelligent communication systems. This integrated approach can address the limitations of individual technologies and provide comprehensive solutions for the challenges faced by future wireless networks [19]. For instance, ISAC can utilize the environmental information provided by sensing to optimize NOMA power allocation and IRS configuration, thereby enhancing overall system performance [20]. The application of ISAC-NOMA-IRS in various domains such as smart cities, autonomous driving, and industrial automation holds immense potential. In smart cities, this integrated framework can support a wide range of services, from enhanced mobile broadband (eMBB) to URLLC, ensuring seamless connectivity and efficient resource management [21]. In autonomous driving, real-time sensing and communication capabilities can enable safer and more efficient vehicle-to-everything (V2X) communication [22].

Over the years, the potential of ISAC in advancing the objectives of 6G has been extensively explored. The ISAC system is set to deliver high-resolution sensing, localization, imaging, and environmental reconstruction capabilities, enhancing communication performance while simultaneously expanding the range of network service scenarios. Broadly the use cases of the ISAC can be categorized [23] as shown in Figure 1.

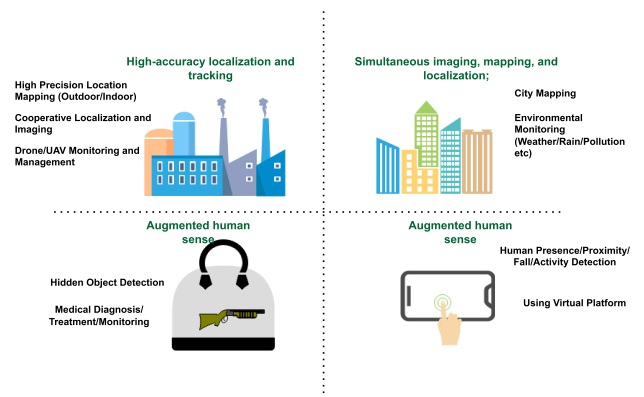

FIGURE 1. Broad categories of ISAC use cases in 6G.

Thus, the significance of ISAC for the future generation of society is evident. The potential of ISAC to enhance societal well-being motivates the authors to explore its capabilities and investigate the integration of ISAC with NOMA and IRS. However, achieving these goals requires addressing numerous challenges. The deployment of ISAC-NOMA-IRS presents significant obstacles, including the need for sophisticated algorithms for joint optimization, the complexity of hardware implementation, and potential security and privacy concerns associated with integrated sensing [24]. Motivated by these challenges, the authors have addressed all the related issues in this review.

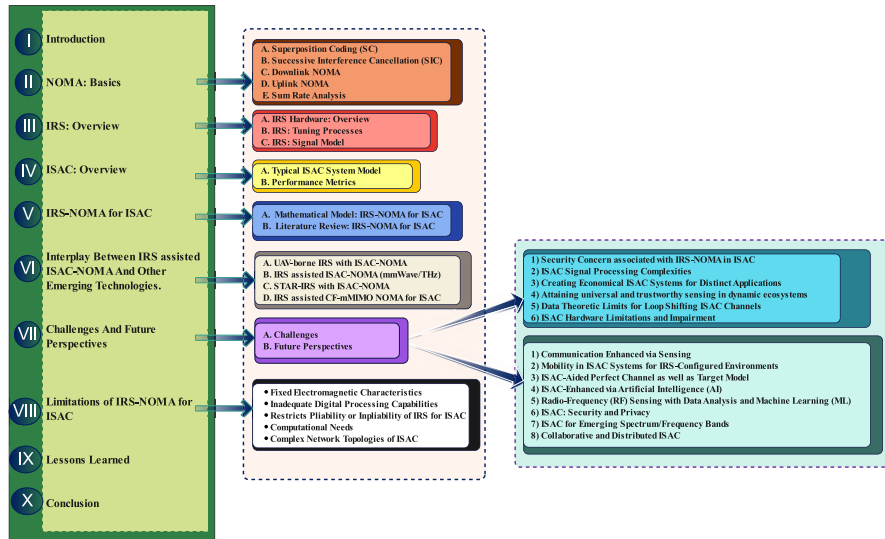

FIGURE 2. Organization of the paper.

TABLE 1. List of acronyms and corresponding definitions.

Acronym	Definition
NOMA	Non-Orthogonal Multiple Access
SC	Superposition Coding
SIC	Successive Interference Cancellation
BS	Base Station
UE	User Equipment
DL	Downlink
UL	Uplink
UE	User Equipment
LOS	Line of Sight
NLoS	Non-Line of Sight
IRS	Intelligent Reflecting Surface
AWGN	Additive white Gaussian noise
ISAC	Integrated Sensing and Communication
RCC	Radar-Communication Coexistence
DFRC	Dual-functional Radar-Communication
SCNR	Signal to Clutter Plus Noise Ratio
SNR	Signal to Noise Ratio
Pd	Probability of Detection
Pfa	Probability of False Alarm
MSE	Mean Squared Error
CRB	Cramér-Rao Bound
FIM	Fisher's Information Matrix
EC	Ergodic Capacity
OC	Outage Capacity

A. CONTRIBUTIONS

We summarize the main contributions of this paper as follows:

- It provides a comprehensive overview on the NOMA and IRS along with related mathematical modeling. Tuning of IRS elements is the most critical aspect of the IRS-assisted networks as it greatly influence the overall system performance. It provides an outline about the tuning process involves in the IRS.
- A comprehensive overview on the ISAC is presented including its architectural overview, frequency band of operation, application areas and present technological standards. It also highlights the relative merits and demerits of different configurations.

- It provides a comprehensive overview of the performance matrices to evaluate the performance of the radar and communication system for an ISAC system.
- It highlights the fundamental mathematical model for the IRS-NOMA assisted ISAC system along with the progress of the IRS-NOMA assisted ISAC related works. This includes a tabulated overview of system metric utilization, a comparison of algorithms related to IRS-NOMA-aided ISAC, and distinct IRS-NOMA approaches within ISAC systems, along with a thorough discussion on the objective, methodology, IRS deployment strategies, and related achievements.
- It further emphasizes the interplay between IRS-aided ISAC NOMA and augment other emerging technologies towards the connectivity framework of 6G. It lays out the broader framework for how these integrated technologies may align with the vision for forthcoming wireless communications.
- Addressing Implementation Challenges: We discuss the significant practical challenges and implementation issues associated with IRS-NOMA in ISAC, related to algorithmic complexities, i.e., signal processing complexities, hardware limitations and impairment, and security and privacy concerns associated with IRS-NOMA in ISAC, and also highlight future perspectives.
- It also highlights the limitations associated with the integration of IRS, NOMA, and ISAC. Furthermore, we have summarized the lessons learned from this study.

B. RELATED WORK AND EXISTING SURVEYS

The up-to-date list of surveys [25], [29], magazine [26], [27], [28] and mini survey paper [30] that have discussed IRS are shown in Table 2. To the best of the authors' knowledge, the present survey paper addresses a wide range of topics

TABLE 2. A comprehensive list of the existing survey papers and magazine articles and comparison.

Reference	Year	Type	NOMA	IRS	ISAC-A	ISAC-PM	INI	CHN	FP	Lim	LL
[25]	2024	Survey	×	✓	×	×	×	✓	✓	×	×
[26]	2024	Magazine	✓	×	✓	×	×	×	✓	×	×
[27]	2023	Magazine	×	✓	✓	×	×	✓	✓	×	×
[28]	2023	Magazine	×	✓	✓	✓	×	✓	✓	×	×
[29]	2023	Survey	×	✓	×	×	×	✓	✓	×	×
[30]	2023	Mini-Review	×	✓	×	×	×	✓	×	×	×
This work		Survey	✓	✓	✓	✓	✓	✓	✓	✓	✓

ISAC-Architecture: ISAC-A; ISAC-Performance Matrices: ISAC-PM; IRS-NOMA for ISAC: INI; Challenges: CHN; Future Perspective: FP; Limitations: Lim; Lesson Learned: LL [Discussed: ✓; Not Discussed: ×]

related to the IRS–NOMA assisted ISAC in comparison to the existing survey papers. Emphasizing the novelty and uniqueness of this survey compared to existing surveys. This survey paper provides a novel contribution to the field by offering the first comprehensive investigation of IRS-assisted NOMA systems specifically applied to ISAC as per the authors knowledge. It highlights both technical and practical challenges, outlines state-of-the-art solutions, and proposes potential research directions, setting a foundation for future research and development in next-generation wireless networks.

C. ORGANIZATION OF THE PAPER

The rest of the paper is structured as follows: Section II provides a basic understanding of NOMA and related signal processing techniques. An overview of IRS is presented in Section III, including discussions on related signal processing approaches and various tuning techniques. Section IV covers the fundamentals of ISAC and its different configurations, highlighting the relative merits and demerits of these system configurations, as well as addressing key parameter metrics [18]. Section V discusses IRS-NOMA-assisted ISAC and related works. Section VI highlights the possible interplay between the IRS assisted ISAC NOMA with the other technologies. The challenges and future perspectives are highlighted in Section VII. Several limitations are discussed in Section VIII. In Section IX, we provide the lessons learned through this study. Finally, Section X summarizes the paper. More detailed about the organization of the paper is depicted in Figure 2. The list of abbreviations used in this survey paper is presented in Table 1.

II. NOMA: BASICS

This section highlights the basic concept of the Superposition Coding and Successive Interference Cancellation methods. It also includes the basic signal processing model for downlink/uplink NOMA.

A. SUPERPOSITION CODING (SC)

The idea of SC was first introduced in [31]. In this approach of the SC scheme is used to enable the transmission of information from a single source to multiple receivers. The SC scheme is further investigated in [32]. Further in [33], the authors have implemented the SC based transmission

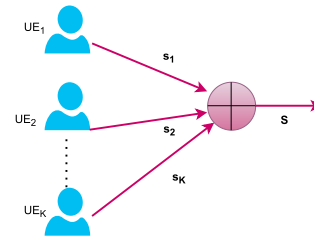

FIGURE 3. Superposition Coding (SC) scheme.

scheme. In this scheme, multiple user’s data (Here, K UEs) are superimposed to produce the composite signal for the transmission and the same is depicted in Figure 3. The composite signal (s) can be expressed as

$$s = \sum_m^K \sqrt{\alpha_m P} s_m, \tag{1}$$

where, s_m is the information from the mth UE, α_m is the power coefficients (∑_{i=1}^K α_i = 1) corresponding to mth UE and the total power allocation for the K UEs is limited to P. To counter the interference due to this superimposition, it is required to implement SIC at the receiver side.

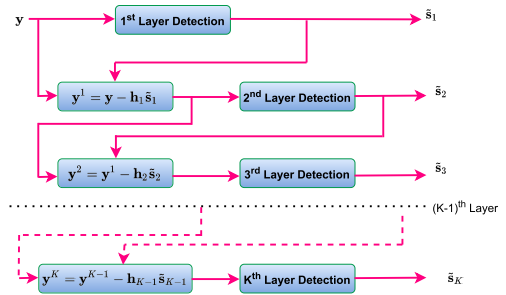

FIGURE 4. Successive Interference Cancellation (SIC) receiver.

B. SUCCESSIVE INTERFERENCE CANCELLATION (SIC)

The basic architecture of the SIC scheme is depicted in Figure 4. The SCI [34] is particularly important to decode the UE signal from the superimposed coded signal. The basic operation of the SIC relies on exploiting the power differences among UEs (who’s signal are superimposed). In this iterative algorithm, the data is decoded according to the decreasing

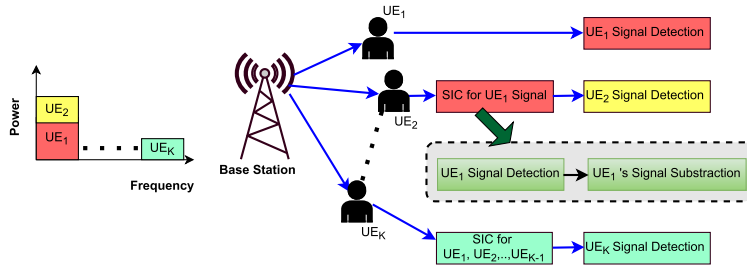

FIGURE 5. Downlink NOMA.

power levels. It means that data corresponding to the UE having strongest power is decoded first, then the data of UE having the next highest power is decoded. The process will continue till all the user's data are decoded.

With the brief description of SC and SIC, the following section provides an overview of NOMA in downlink and uplink networks along with a relative comparison between OMA and NOMA techniques.

C. DOWNLINK NOMA

As in Figure 5, at the transmitter side, the BS transmits the combined signal towards the users. The combined signal in a DL-NOMA networks is basically a superposition of the desired signals corresponding to the multiple users with user specific power coefficients. The selection of the power coefficient depends on the channel condition corresponding to each users and in an inversely proportionate. Under this scheme, lesser power is allocated for the user with good channel condition and higher power towards the user with bad channel condition. The heart of receiver signal processing is the SIC processor, which is discussed in detail in the later part of this section. In a brief, in SIC, the receiver at the user end first detect the stronger signals and are subtracted from the received signal. This process continues until the desired user is able to extract its own signal.

In DL scenario, the BS transmits s_i signal to towards the i^{th} UE considering the corresponding power coefficients α_i ($\sum_{i=1}^K \alpha_i = 1$). The total power allocation for the K UEs is limited to P . Therefore, the superimposed signal transmitted from the BS can be represented as,

$$S = \mathbf{w} \sum_{i=1}^K \sqrt{\alpha_i P} s_i \quad (2)$$

Based on the concept of NOMA, the order of the channel gains are assumed to be $|h_1^2| \leq |h_2^2| \leq \dots \leq |h_K^2|$ corresponding to the power coefficients order $\alpha_1 \geq \alpha_2 \geq \dots \geq \alpha_K$. The channel gain can be maximized using the precoding matrix \mathbf{w} . The received signal (y_m) corresponding to the m^{th} UE can be expressed as

$$y_m = \mathbf{w} h_m \sum_{i=1}^K \sqrt{\alpha_i P} s_i + n_m, \quad (3)$$

where $n_m \sim CN(0, \sigma^2)$ and h_m is the channel coefficient corresponding to m^{th} UE.

D. UPLINK NOMA

Figure 6 represents a uplink NOMA (UL-NOMA) network. As in Figure 6, each UE transmits its signal towards the BS. SIC process is carried out to detect the signal corresponding to each UEs. Considering the same channel conditions and power coefficients as discussed in the DL scenario, the received signal at the BS under the UL scenario can be expressed as

$$y = \mathbf{w} \sum_{i=1}^K h_i \sqrt{\alpha_i P} s_i + n, \quad (4)$$

where $n \sim CN(0, \sigma^2)$ and h_i is the channel coefficient corresponding to i^{th} UE. P is the maximum transmission power and it is assumed to be common for all UEs. The received precoding matrix is denoted by \mathbf{w} .

E. SUM RATE ANALYSIS

This section deals with the overview on the sum rate of the DL-NOMA and UL-NOMA. Considering the signal model as in (3), the SNIR [35], [36] corresponding to the m^{th} UE can be expressed as,

$$SNIR_m = \frac{\alpha_m \gamma |\mathbf{w} h_m|^2}{\gamma |\mathbf{w} h_m|^2 \sum_{i=m+1}^K \alpha_i + 1}, \quad (5)$$

The DL-NOMA rate corresponding to the m^{th} UE can be expressed as

$$\begin{aligned} R_m^{DL-NOMA} &= \log_2 (1 + SNIR_m) \\ &= \log_2 \left(1 + \frac{\alpha_m \gamma |\mathbf{w} h_m|^2}{\gamma |\mathbf{w} h_m|^2 \sum_{i=m+1}^K \alpha_i + 1} \right), \quad (6) \end{aligned}$$

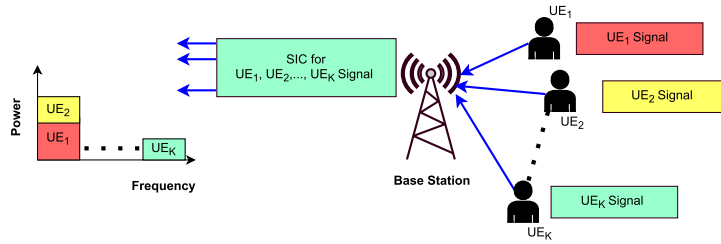

FIGURE 6. Uplink NOMA.

Here, γ represents the SNR ($\gamma = P/\sigma^2$). Thus, the sum rate of DL-NOMA can be expressed as

$$\begin{aligned}
 R_{sum}^{DL-NOMA} &= \sum_{m=1}^K \log_2 (1 + SNIR_m) \\
 &= \sum_{m=1}^{K-1} \log_2 \left(1 + \frac{\alpha_m \gamma |wh_m|^2}{\gamma |wh_m|^2 \sum_{i=m+1}^K \alpha_i + 1} \right) \\
 &\quad + \log_2 (1 + \alpha_K \gamma |wh_K|^2), \quad (7)
 \end{aligned}$$

The last term in (7) represents the SINR of the K^{th} UE.

Similarly, the sum rate can be done for UL-NOMA system. As in [36], corresponding to the m^{th} UE ($m \neq 1$) can be expressed as,

$$SNIR_m = \frac{\alpha_m \gamma |wh_m|^2}{\gamma \sum_{i=1}^{m-1} \alpha_i |wh_i|^2 + 1}. \quad (8)$$

The sum rate of UL-NOMA can be expressed as

$$\begin{aligned}
 R_{sum}^{UL-NOMA} &= \sum_{m=1}^K \log_2 (1 + SNIR_m) \\
 &= \log_2 (1 + \alpha_1 \gamma |wh_1|^2) \\
 &\quad + \sum_{m=2}^K \log_2 \left(\frac{\alpha_m \gamma |wh_m|^2}{\gamma \sum_{i=1}^{m-1} \alpha_i |wh_i|^2 + 1} \right), \quad (9)
 \end{aligned}$$

where the first term ($\alpha_1 \gamma |wh_1|^2$) represents the SNIR corresponding to the first UE.

III. IRS: OVERVIEW

This section highlights the hardware aspect of the IRS design along with the discussion on the tuning processes. Furthermore, it also highlights the mathematical modeling for the single/multi IRS system.

A. IRS HARDWARE: OVERVIEW

The IRS is composed of a programmable metasurface that can fully control the phase shifts corresponds to the scattering elements [37], [38], [39], [40], [41]. This can be achieved by subjecting the scattering elements to an external stimulus that changes their physical properties and thereby alter the EM properties of the metasurface [37], [39], [42]. A typical IRS structure is presented in Figure 7.

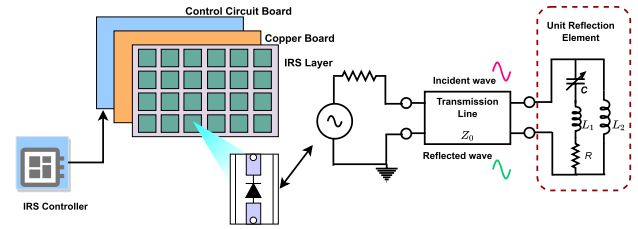

FIGURE 7. IRS structure.

As in Figure 7, IRS comprising three distinct layers and a smart controller. The first layer, referred to as the IRS layer, consists of a dielectric substrate hosting multiple tunable and reconfigurable metallic patches to directly manipulate incoming waves. In most cases, copper is employed in the second layer to mitigate transmission power losses arising from IRS reflection. The third layer comprises a control integrated board, responsible for both excitation and real-time controlling the reflection amplitudes and phase shifts of the individual reflecting elements.

Within this context, the metasurface plays a pivotal role in the effective implementation of the IRS [43]. This metasurface comprises a multitude of scattering elements, often composed of metal and dielectric materials. It leverages its scattering, focusing, and polarization properties to craft the desired beam pattern [44], [45]. As detailed in [46] and [39], advancements in micro-electro-mechanical systems (MEMS), field-effect transistors (FET), liquid crystals, graphene, varactors, and PIN diodes have made it economically viable to create metasurfaces. Once a metasurface is fabricated with a specific structure, it exhibits fixed electromagnetic properties.

However, to be effective for IRS, a metasurface must be reconfigurable. In the case of a metasurface, altering the surface impedance causes an abrupt change in the incoming signal. This fundamental principle is harnessed in IRS to generate the desired beam formation. In simpler terms, it means that the reflection coefficient of each element within the metasurface should be tunable to accommodate user mobility. The development of MEMS, FETs, and PIN diodes has made this reconfigurability feasible. In practical applications, a controller, often implemented using a field-programmable gate array (FPGA), comes into play. As illustrated in Figure 7,

TABLE 3. Tuning processes.

Type	Element	Band Compatibility	Control Method
Circuit Tuning	Varactor Diode [48]	M/MW	Bias Voltage
	PIN Diode [49]	M/MW	Bias Voltage
	Complementary Metal-Oxide-Semiconductor (CMOS) Transistor [50]	T	Bias Voltage
	High-Electron Mobility Transistors (HEMTs) [51]	T	Bias Voltage
Geometric Tuning	Micro electromechanical systems (MEMS) [52]	T	Bias Voltage
	High impedance surfaces (HIS) [48]	T	Bias Voltage
Material Tuning	Ferroelectric films [53], [54]	M/MW	Bias Current
	$[Ba_{0.6}Sr_{0.4}TiO_3]$ (BST)	T	Bias Current
	Ga-Sb-Te (SGT) [55]	T	Bias Voltage
	Liquid crystal [56]	T	Bias Voltage
	Graphene [57], [58]	T	Bias Voltage
Vanadium Dioxide (VO_2) [59]	MW/T	Joule Heating	

Microwave Band: M; Millimeter-wave: MW; Terahertz: T

an embedded controller has the capability to interface with the external world, facilitating the reconfiguration of each metasurface element by disseminating optimized phase information [15], [37].

There are several research works where the first layer is completely build with the passive elements but this approach leads to a significant challenge in channel estimation. Furthermore, dedicated sensors may be strategically deployed within the first layer, potentially interwoven with the IRS's passive reflecting elements. The approach of combining passive elements with the strategically placed active elements improve the optimization of the reflection coefficients, thereby enhancing the IRS's ability to adapt to its environment [37]. Although there are studies, where researchers are dividing the IRS elements into subgroups to reduce the overhead for the channel estimation [47].

B. IRS: TUNING PROCESSES

Hence, it becomes evident that configurability or tunability stands as a critical factor in unlocking the full potential of the IRS. In the realm of tuning processes within the context of IRS, researchers have identified three fundamental categories as elucidated in the literature: Circuit Tuning, Geometric Tuning, and Material Tuning. Each of these categories plays a crucial role in tailoring the performance of IRS to meet specific objectives. Circuit Tuning encompasses the fine-tuning of IRS by adjusting individual impedance elements within the unit cell circuit model. This intricate process involves the strategic deployment of adjustable capacitors and switches, both within the unit cells themselves and at inter-cellular connections. Through these adjustments, the electrical characteristics of the IRS can be precisely controlled, allowing for dynamic impedance changes to optimize its performance for various applications. Geometric Tuning takes a more physically transformative approach. In this method, modifications are made to the shape or structure of the unit cell itself. These alterations have a profound impact on the corresponding circuit model, resulting in significant changes to the IRS's electromagnetic

behavior. Material Tuning, revolves around the manipulation of material properties within the IRS. This involves altering the characteristics of the substrate or specific segments within unit cells to influence the reactivity and attributes of the substrate layer or specific components of the unit cell.

In the pursuit of impedance reconfigurable surfaces, it's essential to consider these three tuning processes, as they collectively enable precise control and optimization of IRS behavior. The elements related to these tuning processes are summarized for your reference in Table 3. Additionally, the literature [55] also highlights the significance of phase-change materials in the context of IRS. A comprehensive discussion of various phase-change materials and their potential contributions to IRS technology can be found in [55].

C. IRS: SIGNAL MODEL

This section presents the pictorial representation and mathematical signal model for various scenarios, considering both single and multiple IRS configurations.



(a) With LoS link



(b) In absence of LoS link

FIGURE 8. IRS assisted communication system with single user.

1) SINGLE-IRS SINGLE USER

In Figure 8, we illustrate a simplified communication system featuring an IRS that assists in DL communication. In this setup, a single IRS is deployed to support a user or mobile station (MS). The IRS comprises N_e discrete reflecting

elements, each MS is equipped with N_m antennas, and the BS is equipped with N_b antennas. The system configuration involves both direct/LoS and a NLoS/reflected path. In this context, we denote the channel between BS and MS as $h_{bm} \in \mathbb{C}^{N_b \times N_m}$. Additionally, we use $h_{im} \in \mathbb{C}^{N_b \times N_e}$ to represent the channel matrix between the MS and IRS. Similarly, we refer to $h_{bi} \in \mathbb{C}^{N_e \times N_m}$ as the channel matrix associated with the link between the IRS and BS. The expression for the received signal at the user corresponding to the transmitted signal \mathbf{x} is as follows:

$$\mathbf{y} = (\mathbf{h}_{bm} + \mathbf{h}_{im}\boldsymbol{\psi}\mathbf{h}_{bi}) \mathbf{p}\mathbf{x} + \mathbf{u} \quad (10)$$

$$\mathbf{y} = \underbrace{(\mathbf{h}_{bm}\mathbf{p}\mathbf{x})}_{\text{Uncontrollable}} + \underbrace{(\mathbf{h}_{im}\boldsymbol{\psi}\mathbf{h}_{bi}) \mathbf{p}\mathbf{x}}_{\text{Controllable}} + \mathbf{u}, \quad (11)$$

Here, \mathbf{u} represents the AWGN channel, and \mathbf{p} represents the precoding matrix employed by the BS for the specific MS. Notably, the path denoted as h_{bm} is uncontrollable, whereas the reflected path can be actively managed by leveraging the phase ($\boldsymbol{\psi}$) distribution of the IRS elements.

2) MULTI-IRS MULTI USER

Figure 9 and Figure 10 depict the configuration of an IRS-assisted communication system, illustrating both the UL and DL scenarios. In this setup, multiple (L) IRSs are incorporated within the network to provide service to the K MSs. It is important to note that within this system, there exists a direct communication link between each MS and the BS. Moreover, the communication path involves a cascaded channel, which includes reflections at the IRS, adding a layer of complexity and adaptability to the overall communication process.

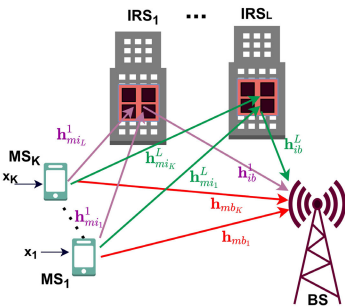

FIGURE 9. IRS-assisted UL communication system: multi-IRS and multi-user.

In the diagram presented in Figure 9, we have several key channel matrices representing different segments of the communication system; $h_{mk} \in \mathbb{C}^{N_b \times N_m}$ signifies the channel matrix corresponding to the k^{th} MS's link to the BS. The $h_{mi}^l \in \mathbb{C}^{N_e \times N_m}$ denotes the channel matrix representing the connection between the k^{th} MS and the l^{th} IRS. Similarly, $h_{ib}^l \in \mathbb{C}^{N_b \times N_e}$ is the channel matrix associated with the path between the l^{th} IRS and the BS. The advantages of utilizing IRS can be harnessed through careful design of the phase matrix and the phase shift matrix,

denoted as $\boldsymbol{\psi} = \varrho \text{diag}(e^{j\phi_1}, \dots, e^{j\phi_{N_e}})$. Here, each $\phi_i \in [0, 2\pi]$, where $i = 1, \dots, N_e$, represents the phase shift corresponding to the i^{th} element of the IRS, and $\varrho \in [0, 1]$ signifies the reflection coefficient. Furthermore, to specify the phase matrix associated with the l^{th} IRS, we use the notation $\boldsymbol{\psi}^l$. This approach allows for precise control over the reflected signals, enabling optimization and enhancement of the communication system's performance.

Considering the system as illustrated in Figure 9, the received signal at the BS corresponding to the transmitted signal \mathbf{x}_k from the k^{th} MS is given by:

$$\mathbf{y} = \sum_{k=1}^K \left(\mathbf{h}_{mk} + \sum_{l=1}^L \mathbf{h}_{ib}^l \boldsymbol{\psi}^l \mathbf{h}_{mi}^l \right) \mathbf{p}_k \mathbf{x}_k + \mathbf{u} \quad (12)$$

where, \mathbf{u} denotes the complex valued AWGN channel and \mathbf{p}_k represents the precoding matrix corresponding to the k^{th} MS. The received signal at the BS can be processed to estimate the transmitted signal, \mathbf{x} . This estimation, denoted as $\hat{\mathbf{x}}$, is achieved by utilizing an appropriate filter represented as \mathbf{W} , as follows: $\hat{\mathbf{x}} = \mathbf{W}^H \mathbf{y}$. Here, $\hat{\mathbf{x}}$ represents the estimated signal at the BS, and \mathbf{W} denotes the filter used for this purpose.

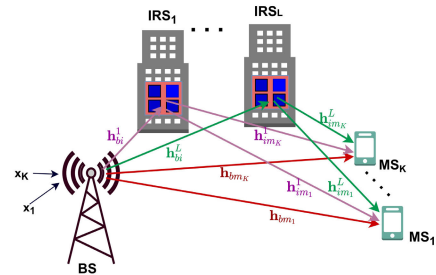

FIGURE 10. IRS-assisted DL communication system: multi-IRS and multi-user.

Here, BS allocate $N_{x,k}$ streams for each MSs and \mathbf{x}_k is the signal transmitted towards the k^{th} MS. In above Figure 10, $h_{mk} \in \mathbb{C}^{N_b \times N_m}$ represents the channel matrix corresponding to k^{th} MS to BS. And $h_{imk}^l \in \mathbb{C}^{N_b \times N_e}$ denotes the channel matrix between the k^{th} MS and l^{th} IRS. Similarly, $h_{bi}^l \in \mathbb{C}^{N_e \times N_m}$ is the channel matrix related to the path between the l^{th} IRS and BS. Similarly, considering the system as in Figure 10 the received signal at the k^{th} MS corresponding to the transmitted signal \mathbf{x}_k can be expressed as

$$\mathbf{y}_k = \left(\mathbf{h}_{mk} + \sum_{l=1}^L \mathbf{h}_{imk}^l \boldsymbol{\psi}^l \mathbf{h}_{bi}^l \right) \sum_{k=1}^K \mathbf{p}_k \mathbf{x}_k + \mathbf{u}_k \quad (13)$$

Similar to the previous case, the signal corresponding to each MS can be estimated ($\hat{\mathbf{x}}_k$) by utilizing appropriate filter (\mathbf{W}_k), i.e. $\hat{\mathbf{x}}_k = \mathbf{W}_k^H \mathbf{y}_k$.

This section outlines a fundamental signal processing model for IRS-assisted system. When applied in the context of communication, localization and energy harvesting etc, there exist exciting prospects for the development of novel signal processing algorithms. These algorithms can

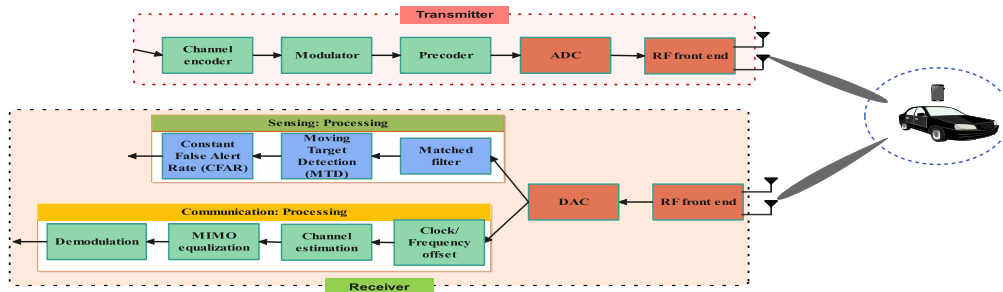

FIGURE 11. Simplified ISAC block diagram.

effectively tackle various aspects, including; Scaling Laws, Near-Field Propagation Challenges, Channel Modeling with Sparsity, Mutual Coupling and IRS Mobility etc. In essence, the research challenges in IRS-assisted signal processing encompass system modeling, algorithm design, and optimization to harness the full potential of IRS technology and achieve maximal signal gain in various applications. These challenges present exciting opportunities for innovation and advancement in the field of future generation wireless communication system.

IV. ISAC: OVERVIEW

The development of next-generation wireless networks, encompassing beyond 5G (B5G) and 6G, has been heralded as a pivotal advancement with the potential to empower a wide range of emerging applications. To meet the demands of these applications effectively, these networks must offer not only high-quality wireless connectivity but also unparalleled sensing capabilities. The role of sensing in B5G/6G networks is envisioned to surpass previous levels of importance and significance [60], [61]. At the same-time, telecommunications companies are actively exploring avenues for re-purposing spectrum that is currently allocated for other purposes. Radar frequency bands emerge as highly promising options for sharing with diverse communication systems due to the substantial spectrum resources they offer [5], [62]. Consequently, there exists a mutually beneficial scenario through the integration of radar and communication systems. This has sparked interest in the emerging research area known as *Integrated Sensing and Communications* (ISAC) [63]. A simplified block diagram is depicted in Figure 11.

Specifically, there are two primary research directions within this field: Radar-Communication Coexistence (RCC) and Dual-functional Radar-Communication (DFRC) [64]. RCC endeavors to advance effective interference management techniques, enabling the concurrent operation of both systems without causing undue interference [65], [66]. In contrast, DFRC techniques are geared toward creating integrated systems capable of seamlessly conducting wireless communication and remote sensing simultaneously [66], [67]. Typical system models for RCC and DFRC are pre-

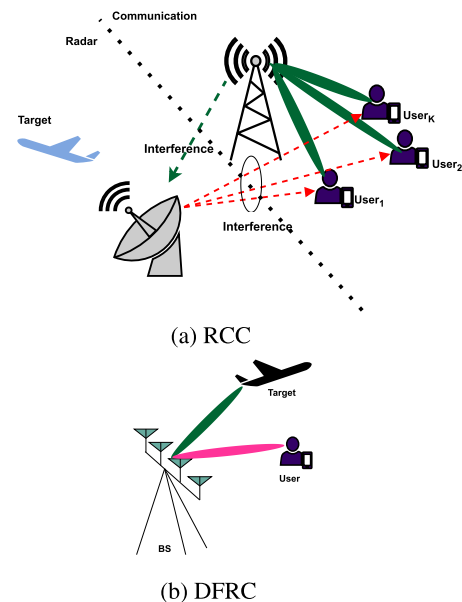

FIGURE 12. Joint radar communication system.

sented in 12a and 12b respectively. Considering the RCC system architecture, there are several limitations such as, it need for two different systems with proper coordination, severe interference, synchronization and compatibility [5]. In case of a DFRC system, this integrated approach offers several advantages, including improved efficiency in terms of size, power consumption, and cost when compared to the RCC systems. However, it's important to note that because radar and communication functionalities share critical resources like spectrum, power, and antennas, DFRC methods often come with a trade-off, resulting in some degradation in both radar and communication performance [68]. In this regard a summary of the coexistence of the radar and communication system is presented in Table 4.

Based on the target location and ISAC transmitter and receiver sections, the ISAC system configuration can be characterized into four categories [83]. The architectures corresponding to each categories are presented in Figure 13.

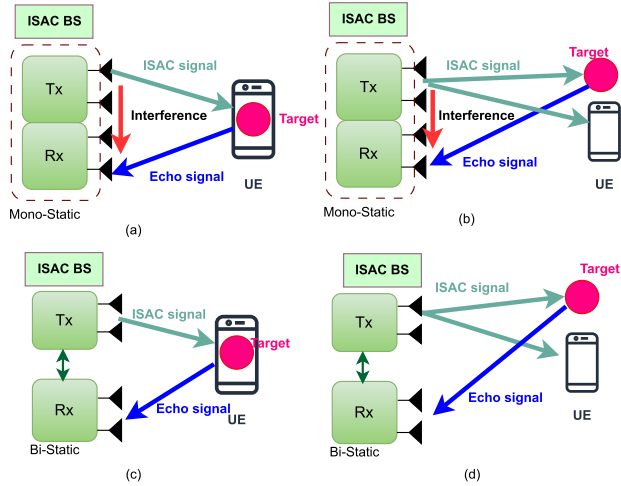

FIGURE 13. System configurations of ISAC. (a) Mono-static ISAC BS and radar-targeted UE. (b) Mono-static ISAC BS and non-targeted UE. (c) Bi-static ISAC BS and radar-targeted UE (d) Bi-static ISAC BS and non-targeted UE.

Table 5 summarized the features and challenges corresponding to each category.

A. TYPICAL ISAC SYSTEM MODEL

Figure 14 illustrates a DL-ISAC system, wherein N_t transmitter antennas (Tx) are utilized at the ISAC-BS, and N_r receiver antennas (Rx) are employed. Here, the User Equipment (UE) is equipped with a signal antenna system. The overall system signal model can be segregated into two components: the sensing model and the communication model. Subsequent sections provide concise mathematical models for these components. Initially, we address the sensing model. As in Figure 14, we assume that there are L paths [One LoS and $L - 1$ NLoS Paths]. And for the simplification we assume that LoS path contains desired target information and NLoS paths are from clutter source.

Let $\mathbf{x} = [x_0, x_1, \dots, x_{L-1}]^T \in \mathbb{C}^{L \times 1}$ be the transmitted signal from the ISAC-BS. Therefore, the received signal at the ISAC-BS can be expressed as in (14),

$$\mathbf{y}_r = \underbrace{\alpha_0 \sqrt{p_0} \mathbf{b}(\theta_0) \mathbf{a}^H(\theta_0) \mathbf{F} \mathbf{x}}_{\text{LoS Path}} + \sum_{l=1}^{L-1} \underbrace{\alpha_l \sqrt{p_l} \mathbf{b}(\theta_l) \mathbf{a}^H(\theta_l) \mathbf{F} \mathbf{x}}_{\text{NLoS Path}} + \mathbf{n}_r, \quad (14)$$

where α_0 and $\alpha_l (\forall l, \dots, L-1)$ represents the reflection coefficients corresponding to the desired target and the l^{th} clutter. The transmitted powers corresponding to LoS and NLoS path are represented by p_0 and p_l respectively. Here, the angles corresponding to the target and the l^{th} clutter are denoted by θ_0 and θ_l respectively. The transmit and receive steering vectors are represented by $\mathbf{a}(\theta)$ and $\mathbf{b}(\theta)$. $\mathbf{F} = [\mathbf{f}_0, \mathbf{f}_1, \dots, \mathbf{f}_{L-1}] \in \mathbb{C}^{N_t \times L}$ represents the transmit beamforming matrix. The additive white Gaussian noise (AWGN) vector is denoted by \mathbf{n}_r with variance of $\sigma_{n_r}^2$. As in [92], the received sensing signal after the receiver

beamforming at the ISAC-BS can be expressed as in (15),

$$\mathbf{y}_s = \alpha_0 \sqrt{p_0} \mathbf{w}^H \mathbf{b}(\theta_0) x_0 + \sum_{l=1}^{L-1} \alpha_l \sqrt{p_l} \mathbf{w}^H \mathbf{b}(\theta_l) x_l + \mathbf{w}^H \mathbf{n}_r, \quad (15)$$

where \mathbf{w} is the receiver beamforming matrix and it is so formulated to maximize the overall signal to clutter plus noise ratio (SCNR). The overall SCNR can be expressed as in (16),

$$\text{SCNR} = \frac{|\alpha_0 \sqrt{p_0} \mathbf{w}^H \mathbf{b}(\theta_0) x_0|^2}{\sum_{l=1}^{L-1} |\alpha_l \sqrt{p_l} \mathbf{w}^H \mathbf{b}(\theta_l) x_l|^2 + \mathbf{w}^H \mathbf{w} \sigma_{n_r}^2} \quad (16)$$

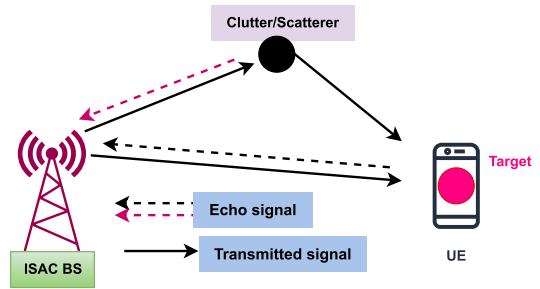

FIGURE 14. Mono-static ISAC system.

As a part of the communication signal modeling, it is assumed that channel information is available to receiver (a communication user (UE)). As in Figure 13, the received communication signal is composed of the LoS and NLoS components. The received signal can be expressed as

$$y_c = \mathbf{h}^H \mathbf{F} \mathbf{x} + n_c, \quad (17)$$

where $\mathbf{h} \in \mathbb{C}^{N_t \times 1}$ represents the channel vector and n_c denotes the AWGN noise with the variance $\sigma_{n_c}^2$. Considering the system model, based on [92], the communication signal to noise ratio can be expressed as in (18),

$$\text{SNR} = \frac{|\mathbf{h}^H \mathbf{F} \mathbf{x}|^2}{\sigma_{n_c}^2} \quad (18)$$

B. PERFORMANCE METRICS

In this section, we first introduce basic sensing and communication performance metrics with some insights. All the performance matrices are summarized in Figure 15.

1) PERFORMANCE METRICS FOR SENSING

In this segment, we outline the essential performance metrics crucial for characterizing the sensing, communication, and ISAC systems.

Three primary categories can be used to classify sensing tasks: detection, estimate, and recognition. These tasks involve assessing gathered signals or information in light of the detected objects [61], [93].

Detection: It is basically refers to the process related to making binary or multiple decision about the intended

TABLE 4. Summary: Radar-Communication coexistence.

Frequency Band	Radar System	Communication System	Reference
L Band	Long-range radar, ATC radar	LTE, 5G NR	[69], [70]
S Band	Moderate-range radar, ATC radar, airborne early warning radar	IEEE 802.11b/g/n/ax/ya WLAN, LTE, 5G NR, NB-IoT	[71]–[74]
C Band	Weather radar, ground surveillance radar, vessel traffic service radar	IEEE 802.11a/h/j/n/p/ac/ax WLAN.	[62], [75]
Ku Band	Military radar	Satellite Communication, NASA's Tracking Data Relay Satellite	
mmWave Band	Automotive radar, High resolution imaging radar	IEEE 802.11 ad/ay WLAN, 5G NR	[75]–[78]
THz Band	Active covert Terahertz imager (ACTI), Concealed weapon imager, Human activity recognition (HAR).	Indoor communication systems, fiber-equivalent wireless links.	[79]–[82]

TABLE 5. Summary: System configurations of ISAC.

Configuration	Features	Challenges	Reference
10(a)	<ul style="list-style-type: none"> The ISAC Tx and radar Rx are co-located in ISAC BS, The radar Rx can use the transmitted signal . No additional time and frequency synchronizations are needed as the Tx and Rx share the same clock and oscillator. 	Self-interference signal can degrade radar sensing performance.	[84], [85]
10(b)	Same as in for 10(a)	Optimization in waveform to minimize the Interference.	[86], [87]
10(c)	<ul style="list-style-type: none"> The ISAC Tx and radar Rx are separated from each other. No additional time and frequency synchronizations are needed as the Tx and Rx share the same clock and oscillator. 	<ul style="list-style-type: none"> The radar Rx do have access of pure reference signal. Time and Frequency Synchronization. Optimal power allocation. Inability to detect targets due to insufficient range resolution or overwhelming transmitted signal strength. 	[88], [89]
10(d)	Same as in for 10(c)	Apart from challenges as in for 10(c), Optimization in waveform to minimize the Interference.	[90], [91]

target under the noisy or under the influence on interference. Usually, binary or multi-hypothesis testing problems can be used to describe detection problem. In case of binary detection problem, two hypotheses are considered, \mathcal{H}_1 : target present and \mathcal{H}_0 : target absent. Generally the performance of any sensing system is assess by probability of detection (Pd) and probability of false alarm (Pfa). Pd is the likelihood that, in light of the occurrence of \mathcal{H}_1 , hypothesis \mathcal{H}_1 is decided. Pfa is the likelihood that, in light of \mathcal{H}_0 events, hypothesis \mathcal{H}_1 is decided. The ability of a detector to attain a specific Pd and Pfa for a particular SNR is used to gauge the detector's performance. Understanding the detection performance can be gained by looking at the receiver operating characteristic (ROC) curves.

Estimation: The process of obtaining valuable information about the sensed object from noisy or interfered-with observations is known as estimation. The estimation performance is generally measured by mean squared error (MSE) and Cramér-Rao Bound (CRB). Furthermore, Weiss-Weinstein Bound (WWB) and Ziv-Zakai Bound (ZZB) can be utilized for the same. The MSE defined the mean squared error between a parameter's estimate (say, $\hat{\theta}$) and true value (θ). The inverse of the Fisher Information (FI), or CRB, is a lower bound on the variance of any unbiased estimator over θ . As in [94], the MSE can be defined as

$$MSE_{\theta} = \mathbb{E} \left[\left(\theta - \hat{\theta} \right) \left(\theta - \hat{\theta} \right)^H \right] \quad (19)$$

Several literature [94], [95] have provided lower constraints on MSE_{θ} in order to obtain more insights. One of the most well-known is the CRB. This CRB can be calculated as it pertains to an unbiased estimator,

$$CRB_{\theta} = I^{-1}(\theta) \quad (20)$$

where $I(\theta)$ is the Fisher's information matrix (FIM) with $(m, n)^{th}$ element $[I(\theta)]_{m,n} = \mathbb{E} \left[\frac{\partial \ln p(y;\theta)}{\partial \theta_m} \frac{\partial \ln p(y;\theta)}{\partial \theta_n} \right]$. The probability function for predicting the unknown deterministic parameter vector θ from the measurements y is denoted by $p(y; \theta)$. When the parameters are random variables with a known prior distribution, the CRB can also be applied [96]. The CRB with prior distribution knowledge is referred to as the posterior CRB. The posterior CRB can be found using

$$CRB_{\theta}^{post} = (I_L + I_{prior})^{-1} \quad (21)$$

where $I_L = \mathbb{E} [I(\theta)]$ is the FIM related to the measurement and I_{prior} is the FIM corresponding to the prior distribution $p(\theta)$ with $(m, n)^{th}$ element $[I_{prior}]_{m,n} = \mathbb{E}_{\theta} \left[\frac{\partial \ln p(\theta)}{\partial \theta_m} \frac{\partial \ln p(\theta)}{\partial \theta_n} \right]$. Bayesian lower bounds, which consider the parameters as random variables with known prior distributions for each, have subsequently been proposed to increase the tightness. Two delegates in the Weiss-Weinstein Bound (WWB) and Ziv-Zakai Bound (ZZB) fall under this group. Although they are more difficult to assess overall, WWB and ZZB both outperform CRB over a large range of SNRs. More details about the WWB and ZZB can be found in [97].

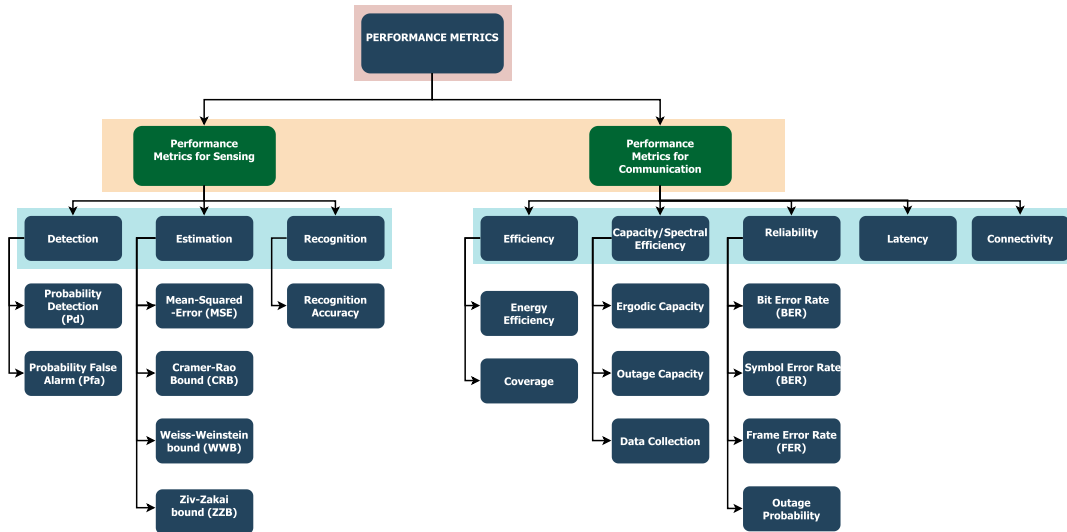

FIGURE 15. Performance metrics: ISAC.

Recognition: Understanding the nature of the detected item based on noisy and/or disturbed observations is known as recognition. At the application layer, recognition is commonly described as a classification task whose performance is assessed using the recognition accuracy metric.

2) PERFORMANCE METRICS FOR COMMUNICATION

We discuss PHY performance indicators for communications in this section. Generally speaking, the performance of a communication system can be evaluated through efficiency, and reliability. Further classification can be made and discussed in the following sections.

Efficiency: The efficiency and the success of the communication system depends on the efficient utilization of the resources, like, frequency-band, spatial resources and power resources etc. Given the restricted resources, the efficiency of a communication system is a indicative parameter that assesses the amount of information that is successfully transferred between the source and destination [98]. Most commonly “spectral efficiency” and “energy efficiency,” are used to highlights the efficiency of a communication system. Furthermore, coverage is also a crucial efficiency measures. Although the spectral efficiency is equal to the capacity normalized by bandwidth and is further detailed in the following section.

Capacity: When the coding block length is long enough, Shannon capacity quantifies the greatest communication rate in bits per transmission at which the likelihood of error can be arbitrarily small. The Shannon capacity refer to the maximum mutual information $I(X, Y)$ corresponding to the channel input X and output Y . The same can be expressed as, $C = \max I(X, Y)$. Furthermore, considering the AWGN channel (with noise variance σ^2) and input signal X with the average power P , the Shannon capacity can be formulated as, $C = \log_2(1 + \frac{P}{\sigma^2})$. As further quantification, ergodic

capacity (EC) and outage capacity (OC) are often used. The EC represents the average maximum data rate corresponding to a communication system under given time varying channel conditions. It is also assumed the CSI is perfectly known to the receiver. Appropriate for fast-fading channels where it matters more to achieve an average performance over time. For each particular instance of the channel, it offers no guarantees. OC refer to the maximum data rate of a communication that can be reliably transmitted over a channel with a certain probability of outage. An outage is a communication breakdown caused by extremely poor channel conditions that allow the transmission rate to surpass the immediate channel capacity. It stands for the capacity with proven reliability in particular. Furthermore, it can be applied to situations requiring strict quality of service or to slow-fading environments. The bit error rate (BER), frame error rate (FER), symbol error rate (SER), and outage probability are examples of frequently used metrics.

Reliability: The ability of a communication system to reliably transfer correct data from a sender to a recipient without errors, lags, or loss is referred to as reliability in communication. Ensuring accurate and effective transmission of information despite various impairments like fading, interference, noise, jamming and other distortions is a crucial feature of communication networks.

Latency: Latency refers to message transmission delays, and essential measurements include round-trip time (RTT), one-way delay, and jitter. Lower latency leads to faster and more responsive communication.

Connectivity: Wireless connectivity is critical since it has a direct impact on the dependability, quality, and efficiency of data transmission. Strong connectivity provides seamless network access, allowing for continuous communication for voice conversations, video streaming, and real-time apps. Connectivity measures the stability and reliability of network links using Network Uptime, Signal Strength, and

Connection Drop Rate. Metrics such as bandwidth utilization and throughput assess the network's data handling capacity.

A comparative analysis related to the exploration of the performance matrices used in different literature are summarized in Table 6.

V. IRS-NOMA FOR ISAC

Integrating IRS with NOMA enhances wireless network capabilities by boosting spectrum and energy efficiency, extending coverage, and accommodating a greater number of users [111], [112], [113]. When paired with NOMA—which allows multiple users to access the same frequency resources—IRS maximizes spectral efficiency and reduces energy consumption, offering a cost-effective and efficient solution for advanced networks like 5G and 6G, which demand high user density and robust coverage [113], [114]. This integration is thus well-suited for ISAC systems. This section provides a foundational mathematical model for an IRS-NOMA-enhanced ISAC system and reviews and compares existing studies in this area.

A. MATHEMATICAL MODEL: IRS-NOMA FOR ISAC

This section presents the mathematical model for an IRS-assisted NOMA system in the context of ISAC, as illustrated in Figure 16.

In the proposed system, a BS is equipped with N_t antennas, serving $2U$ single-antenna UEs, along with T radar targets, and an IRS comprising M reflecting elements. It is assumed that there are no direct links between the UEs and the radar targets. Consequently, the IRS plays a crucial role in establishing virtual line-of-sight (LoS) links between the BS, UEs, and radar targets. As shown in Figure 16, the UEs are distributed across U clusters, with each cluster containing two UEs. Within each cluster, the UEs are supported by the NOMA protocol to ensure efficient resource allocation.

1) COMMUNICATION MODEL

The communication signal transmitted by the BS can be expressed as,

$$\mathbf{x} = \sum_{u=1}^U \mathbf{w}_u \left(\sqrt{\beta_{u,n}} s_{u,n} + \sqrt{\beta_{u,f}} s_{u,f} \right), \quad (22)$$

where $\mathbf{w}_u \in \mathbb{C}^{N_t \times 1}$ denotes the active beamforming vector corresponding to u^{th} cluster. The communication signals corresponding to the near UE ($UE(u, n)$) and far UE ($UE(u, f)$) in the u^{th} cluster are denoted by $s_{u,n}$ and $s_{u,f}$. The power coefficient corresponding to the $UE(u, n)$ and $UE(u, f)$ UEs are denoted by $\beta_{u,n}$ and $\beta_{u,f}$ respectively. And P_{max} represents the maximum transmit power of BS for all UEs in each cluster.

As depicted, there are no direct path between the BS and UEs. The communication links are established via IRS. Let, $\mathbf{H} \in \mathbb{C}^{M \times N_t}$ represents the channel between the BS and IRS. And also, the channel coefficients between the IRS and UEs are represented by $\mathbf{h}_{u,i} \in \mathbb{C}^{M \times 1}$ [where, $i \in n, f$].

Furthermore, the passive beamforming is realized utilizing the IRS element phase shift $\phi_m \in [0, 2\pi)$ and the passive beamforming vector is represented by $\mathbf{F} = [e^{i\phi_1} e^{i\phi_2} \dots e^{i\phi_M}]$. Therefore the received signal at the UEs can be expressed as

$$y_{u,i} = \underbrace{\left(\mathbf{h}_{u,i}^H \Phi \mathbf{H} \right) \mathbf{w}_u \sqrt{\beta_{u,i}} s_{u,i}}_{\text{Desired Signal}} + \underbrace{\left(\mathbf{h}_{u,i}^H \Phi \mathbf{H} \right) \mathbf{w}_u \sqrt{\beta_{u,l}} s_{u,l}}_{\text{Intra-Cluster Interference}} + \underbrace{\left(\mathbf{h}_{u,i}^H \Phi \mathbf{H} \right) \sum_{v \neq u} \mathbf{w}_v \sum_{j \in n, f} \sqrt{\beta_{v,j}} s_{v,j}}_{\text{Inter-Cluster Interference}} + \underbrace{z_{u,i}}_{\text{Noise}}, \quad (23)$$

where $l, i \in n, f$, $l \neq i$ and $\Phi = \text{diag}(\mathbf{F})$ represents the diagonal phase matrix corresponds to the IRS. The additive white Gaussian noise (AWGN) component associated with u^{th} cluster and i^{th} UE is denoted by $z_{u,i} \sim \mathcal{CN}(0, \sigma^2)$. Considering that SIC is applied for the UEs to decode the signal and following [109], the achievable rate for $UE(u, n)$ to decode the signal of $UE(u, f)$ can be expressed as

$$R_{u,f \rightarrow n} = \log_2 \left(1 + \frac{\beta_{u,f} |\mathbf{h}_{u,n}^H \Phi \mathbf{H} \mathbf{w}_u|^2}{I_{u,n}^{\text{intra}} + I_{u,n}^{\text{inter}} + \sigma^2} \right), \quad (24)$$

where $I_{u,n}^{\text{intra}} = \beta_{u,n} |\mathbf{h}_{u,n}^H \Phi \mathbf{H} \mathbf{w}_u|^2$ and $I_{u,n}^{\text{inter}} = \sum_{v \neq u} |\mathbf{h}_{u,n}^H \Phi \mathbf{H} \mathbf{w}_v|^2$. Furthermore, with the successful decoding of $UE(u, n)$'s own signal, the rate can be expressed as

$$R_{u,n} = \log_2 \left(1 + \frac{\beta_{u,n} |\mathbf{h}_{u,n}^H \Phi \mathbf{H} \mathbf{w}_u|^2}{I_{u,n}^{\text{inter}} + \sigma^2} \right) \quad (25)$$

The corresponding SINR can be expressed as

$$\gamma(u, n) = \left(\frac{\beta_{u,n} |\mathbf{h}_{u,n}^H \Phi \mathbf{H} \mathbf{w}_u|^2}{I_{u,n}^{\text{inter}} + \sigma^2} \right) \quad (26)$$

Considering the same approach as in [109], the achievable rate for $UE(u, f)$ to decode its own signal can be expressed as

$$R_{u,f \rightarrow f} = \log_2 \left(1 + \frac{\beta_{u,f} |\mathbf{h}_{u,f}^H \Phi \mathbf{H} \mathbf{w}_u|^2}{I_{u,f}^{\text{intra}} + I_{u,f}^{\text{inter}} + \sigma^2} \right), \quad (27)$$

where $I_{u,f}^{\text{intra}} = \beta_{u,n} |\mathbf{h}_{u,f}^H \Phi \mathbf{H} \mathbf{w}_u|^2$ and $I_{u,f}^{\text{inter}} = \sum_{v \neq u} |\mathbf{h}_{u,f}^H \Phi \mathbf{H} \mathbf{w}_v|^2$. As in 27, the required SINR for the $UE(u, f)$ to decode its own signal can be expressed as

$$\gamma(u, f) = \left(\frac{\beta_{u,f} |\mathbf{h}_{u,f}^H \Phi \mathbf{H} \mathbf{w}_u|^2}{I_{u,f}^{\text{intra}} + I_{u,f}^{\text{inter}} + \sigma^2} \right) \quad (28)$$

Following [109], [115], and [116], the achievable rate for $UE(u, f)$ is given by

$$R_{u,f} = \min(R_{u,f \rightarrow n}, R_{u,f \rightarrow f}). \quad (29)$$

TABLE 6. Exploration of system metrics utilization.

Ref.	Year	IRS	BS	No. of users	CSI	Algorithm	Performance Metrics	Achievement	Limitation
[99]	2024	BH-IRS	Terrestrial	Multiple	Perfect and Imperfect	Composite Distance and Angle-based (CDA), Channel-Oriented Adaptive (COA), Alternative Optimization (AO), and Successive Convex Approximation (SCA)	Sensing -Total Sensing Power and Beampattern Gain; Communication -Average Sum Rate	Boosted the overall communication throughput and strengthened the total target sensing power.	When error tolerance increases, performance declines as channel errors contribute to the overall noise.
[100]	2024	IRS	Terrestrial	Multiple	Perfect	AO and SCA	Sensing -Beampattern Gain; Communication -Sum Secrecy Rate	Sum secrecy rate maximization and reliable target detection.	As the number of BS antennas rises, the sum secrecy rate levels off.
[101]	2024	IRS	Terrestrial	Multiple	Perfect	SCA and AO	Sensing -Transmit Power; Communication -Sum Secrecy Rate and Sum Eavesdropping Rate	Optimization of the sum secrecy rate and simultaneously guaranteeing precise sensing performance.	As the jamming signal threshold's decoding rate rises, more power is devoted to the jamming signal, leading to a slight decline in user transmission rates.
[102]	2024	STAR-IRS	Terrestrial	Multiple	Perfect	SCA and Semidefinite Programming (SDP)	ISAC Fairness (Fairness between communication users and the sensing target)	Optimizing the minimum of the signal-to-interference-plus-noise ratio (SINR) and the signal-to-clutter-and-noise ratio (SCNR). More precisely, optimizing the fairness across the sensing target and communication users.	Since STAR-RIS is totally passive, the phase-shift coefficients for both reflection and transmission can grow interdependent in real-world scenarios, thus complicating the design of passive beamforming.
[103]	2024	Active-IRS	Terrestrial	Multiple	Imperfect	Imperfect successive interference cancellation (i-SIC)	Sensing -Received Sensing SINR at the BS, and Normalized Beampattern; Communication -Outage Probability, Ergodic Rate, and System Throughput	Enhancement of outage probability, ergodic rate, system throughput, and SINR alongside beam-pattern analysis.	Performance might decline more when the angle between the active IRS and the target is wrongly estimated, particularly in highly mobile conditions.
[104]	2024	IRS	Aerial	Multiple	Perfect (potential eavesdropper CSI not available)	AO, SCA, Manifold Optimization (MO), and Dinkelbach's	Sensing -NA; Communication -Average Achievable Rate (AAR), Average Secrecy Rate (ASR), and Energy Efficiency	Improvement of the average achievable rate as well as energy efficiency.	The UAV's optimized trajectory burns more energy in order to optimize the AAR, which reduces the energy efficiency.
[105]	2024	IRS	Terrestrial	Multiple	Perfect	AO, SCA, and Penalty Method	Sensing -Minimum Beampattern Gain; Communication -NA	Enhancing the minimum beampattern gain under the communication rate constraints.	Sensing performance degrades when communication requirements are more stringent.
[106]	2024	STAR-IRS	Terrestrial	Multiple	Perfect	SCA, Block Coordinate Descent (BCD) reliant Integral Matrix (BCDM), Penalty-reliant Method, and BCD reliant Element-Wise (BCDE)	Sensing -Minimum Beampattern Gain; Communication -NA	Enhancing the minimum beampattern gain satisfying the communication and power consumption requirements.	As the number of sensing targets increased, the minimum beampattern gain tumbled.
[107]	2024	Distributed-IRS	Aerial	Single	Perfect	Modified Cramer-Rao Lower Bound (CRLB)-reliant Estimation of Distribution Algorithm (EDA)	Sensing -Angle Estimation, and Localization; Communication -Mutual Information,	Maximized trade-off between the communication and localization performance.	Improving the communication performance would degrade the localization performance and vice versa.
[108]	2023	IRS	Terrestrial	Multiple	Perfect and Imperfect	Dinkelbach, AO, Semidefinite Relaxation (SDR), and Sequential Rank-One Constraint Relaxation (SROCR)	Sensing -NA; Communication -Achievable Rate/Achievable Unicast Rate	Enhancing the uni-cast achievable rate while preserving the minimum target illumination power and multicast rate.	With a fixed transmit power, a higher minimum rate requirement leads to decreased uni-cast achievable rates.
[109]	2023	IRS	Terrestrial	Multiple	Perfect	Iterative BCD (IBCD), SDR, SCA, Sequential Rank-one Constraint Relaxation (SRCR), Iterative AO (IAO.) and SDP	Sensing -Minimum Beampattern Gain/Normalized Beampattern Gain, and Illumination Power; Communication -	Optimization of the minimum beampattern gain.	The minimum beampattern gain shrinks as the transmit power at BS drops.
[110]	2022	IRS	Terrestrial	Multiple	Perfect	AO, SCA, and SRCR	Sensing -Minimum Beampattern Gain/Normalized Beampattern Gain, and Illumination Power; Communication -	Maximization of the minimum beampattern gain.	When transmit power at BS decreases, the minimum beampattern gain monotonically shrinks.

2) RADAR MODEL

For the sensing part, as depicted, it is assumed that the IRS also assists in detecting or sensing the targets. The IRS

reflects the transmitted signal from the BS towards the targets, and the reflected signal from the target is received at the BS. The channel coefficients between the IRS and targets are

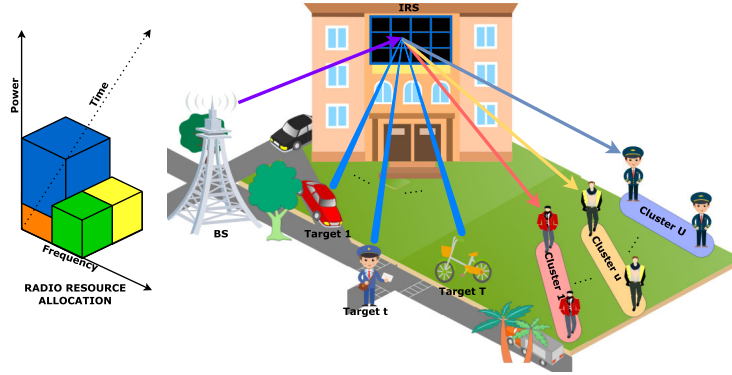

FIGURE 16. IRS-NOMA for ISAC.

represented by $\mathbf{h}_t \in \mathbb{C}^{M \times 1}$. The received sensing signal at the BS can be expressed as,

$$\mathbf{y}_t = \alpha \mathbf{H} \phi \mathbf{h}_t^H \mathbf{w}_u s_u + z_t \quad (30)$$

where s_u is the same communication signal used for the sensing, and $z_t \sim \mathcal{CN}(0, \sigma^2)$ represents the sensing noise. And the reflection coefficient of the target is modeled by α . The sensing SNR at the BS can be expressed as

$$\gamma_t = \frac{|\alpha \mathbf{H} \phi \mathbf{h}_t^H \mathbf{w}_u|^2}{\sigma^2} \quad (31)$$

3) OPTIMIZATION

This section highlights the joint optimization objective formulation. Let w_u^n and w_u^f represents the weights corresponding to the near and far UEs related to the u^{th} cluster. And λ represents the weights for the sensing rate.

The overall objective function combines both the communication and sensing objectives. The goal is to maximize the sum rate of the NOMA users in the communication system and the sensing signal-to-noise ratio (SNR). This can be expressed as the combination of two weighted objectives as given below,

$$\underbrace{\max}_{\beta_{u,n}, \beta_{u,f}, \Phi} \sum_{u=1}^U \left(w_u^n \log_2(1 + \gamma(u, n)) + w_u^f \log_2(1 + \gamma(u, f)) \right) + \lambda \log_2(1 + \gamma_t), \quad (32)$$

The optimization problem as stated in (32) is under the constraints of $\beta_{u,n} + \beta_{u,f} \leq P_{max}, \forall u$ (Power Constraints). Each NOMA cluster has a power limit at the BS. The total power assigned to both the near and far UEs in each cluster must not exceed the maximum permissible transmit power (P_{max}). And the IRS phase shift constraints $\phi_m \in [0, 2\pi), \forall m \in 1, 2, \dots, M$.

This problem is non-convex due to the linkage of power allocation and IRS phase changes in the SINR and SNR equations. There are numerous ways to solve this type of joint optimization problem:- *Alternating Optimization (AO)*: In AO, we alternately optimize the power allocation $\beta_{u,n}, \beta_{u,f}$

and the IRS phase shifts Φ while keeping the other set of variables fixed. The iterative procedure continues until convergence is reached. *Successive convex approximation (SCA)*: The non-convex goal functions (SINR and SNR expressions) can be approximated by convex functions via Taylor series expansions or other linearization approaches. SCA solves the convex approximation iteratively. *Semidefinite relaxation (SDR)*: The IRS phase optimization can be expressed as a semidefinite programming (SDP) issue, with SDR relaxing non-convex constraints to make the problem solvable using convex optimization techniques. The solution is then projected back to meet the initial non-convex restrictions. *Block Coordinate Descent (BCD)*: BCD is another strategy that divides the optimization issue into blocks (for example, optimizing power allocation first, then phase shifts) and optimizes each block iteratively.

B. LITERATURE REVIEW: IRS-NOMA FOR ISAC

IRS and NOMA have emerged as promising technologies to enhance the performance of ISAC systems. ISAC aims to unify sensing and communication functions within a single framework, allowing for efficient resource utilization and improved system capabilities. A typical scenario is presented in Figure 16. By leveraging IRS and NOMA, ISAC systems can achieve higher spectral efficiency, improved sensing accuracy, and more reliable communication links.

IRS, also known as reconfigurable intelligent surfaces, consists of a large array of passive reflecting elements that can adjust the phase and amplitude of incident electromagnetic waves. By smartly configuring these elements, IRS can manipulate the propagation environment to enhance signal quality and coverage. In ISAC systems, IRS can facilitate simultaneous communication and sensing by steering and focusing signals towards desired directions, thereby improving the sensing accuracy and communication reliability. One significant advantage of IRS in ISAC systems is the ability to create virtual line-of-sight (LoS) paths in environments where direct LoS is unavailable. This is particularly useful in urban areas or indoor environments with many obstacles.

By reflecting signals towards intended receivers or sensing targets, IRS can mitigate the impact of blockages and enhance the overall system performance [117]. NOMA is a multiple access technique that allows multiple users to share the same frequency and time resources by superimposing their signals with different power levels. This approach contrasts with traditional OMA schemes, where users are allocated separate resources. By enabling the concurrent transmission of multiple users' signals, NOMA can significantly enhance the spectral efficiency and user capacity of ISAC systems. This improved efficiency is crucial for meeting the high demands of next-generation wireless networks, facilitating more robust and extensive connectivity [118]. In the context of ISAC, NOMA enables efficient resource sharing between communication and sensing tasks. By adjusting the power allocation among users and tasks, NOMA ensures that communication links maintain high quality while also providing sufficient power for accurate sensing. This dynamic resource allocation is essential in scenarios where communication and sensing requirements vary over time, allowing the system to adapt and optimize performance continuously [119]. By leveraging NOMA, ISAC systems can achieve a balance between robust communication and precise sensing, making them more versatile and capable of meeting the diverse demands of next-generation wireless networks [120]. The integration of IRS and NOMA in ISAC systems offers synergistic benefits. IRS can improve the channel conditions for NOMA users, enhancing their ability to decode superimposed signals. Simultaneously, NOMA can optimize the power allocation for users, ensuring that both communication and sensing tasks are performed effectively [15]. For instance, IRS can be utilized to create favorable propagation paths for weaker NOMA users, thereby balancing the received power levels and enhancing decoding performance. This capability is particularly advantageous in scenarios where users experience significant disparities in channel conditions. By strategically adjusting the IRS's reflective elements, it is possible to improve signal quality for users with weaker connections, leading to more equitable performance across the network. Additionally, the reflective elements of IRS can be dynamically reconfigured to adapt to the changing requirements of both communication and sensing tasks, ensuring optimal performance and resource utilization in diverse and evolving network conditions [121]. IRS with NOMA for ISAC represents a revolutionary strategy to boost the efficiency and performance of wireless networks. By utilizing the programmable features of IRS, the propagation environment can be dynamically controlled, enhancing signal quality and minimizing interference. When paired with NOMA, which enables multiple users to utilize the same frequency and time resources, IRS can further enhance spectral efficiency and support a greater density of connected devices. This combination facilitates more accurate sensing and reliable communication, proving especially beneficial in scenarios such as autonomous driving, smart cities, and

industrial automation. The simultaneous optimization of IRS configuration and NOMA power allocation, guided by real-time environmental sensing, can significantly elevate system performance, offering a promising solution to the challenges faced by next-generation wireless networks [122].

By observing the tremendous potential researchers are looking for the integration of IRS and NOMA for the improvement of ISAC. As in [110], the authors examine how IRS might enhance radar sensing in an ISAC network that is enabled by NOAM. By simultaneously optimizing power allocation coefficients, passive beamforming, and active beamforming, the goal is to maximize the lowest radar beam-pattern gain. The authors suggest a successful joint optimization approach that uses sequential rank-one constraint relaxation (SRCR), successive convex approximation (SCA), and alternating optimization to tackle the non-convex issue. The recommended algorithm-equipped IRS-assisted ISAC-NOMA system performs better than the IRS-assisted ISAC system without NOMA, according to numerical results. In [109] a novel ISAC system that simultaneously transmits NOMA communication signals for target sensing and user communications has been proposed. It does this by using a dual-functional base station. Furthermore, a novel sensing structure helped by a IRS is suggested, in which a specific IRS establishes virtual LoS links for radar targets to reduce major path loss or obstruction during sensing activities. In [108], the author investigated the application of an IRS in an Integrated Sensing and Multicast-Unicast Communication (ISMUC) system supported by NOMA. In this system, the unicast signal is exclusively used for communication, but the multicast signal is used for both sensing and communication. The aim is to ascertain if, in imperfect and perfect SIC scenarios, the IRS improves the NOMA-ISMUC system's performance. In order to accomplish this, the author defines a non-convex problem with the following goals: minimum target illumination power, multicast rate maintenance, and unicast rate maximization. It demonstrate that the IRS-assisted NOMA-ISMUC system maintains a similar rate under defective SIC but achieves a greater rate with perfect SIC than NOMA-ISMUC without IRS. The author of [123] has covered DFRC methods. The EE of DFRC systems can be greatly increased with the use of an IRS, which is essential for real-world applications. However, channel limitations and radar performance requirements may place restrictions on the EE obtained with the sum-rate approach. By simultaneously optimizing transmit beamforming and the IRS phase shift matrix under both perfect and imperfect CSI conditions, this work explores the EE maximization problem in an IRS-assisted DFRC system. In [105], an ISAC system, the optimization of IRS is investigated. And NOMA in the power domain is taken into consideration to handle the growing number of devices. In this work by using joint power allocation, active beamforming, and IRS phase shift design, it ensure communication rate limitations while optimizing the sensing beampattern by formulating a max-min issue.

TABLE 7. Summary of works: IRS-NOMA For ISAC.

Year	Ref.	Objective	Methodology	Environmental Setup	IRS Deployment	Achievement
2024	[124]	Maximization of the covert rate.	By exploiting the joint optimization of the transmission beamforming at BS and reflection beamforming at active-IRS, subject to QoS requirements of NOMA public user, constraint of CRB for multi-target estimations, and covertness level against warden.	The targets is consider to fly at low altitudes, resulting in strong LoS links between BS and targets, while active-IRS is deployed far away from targets resulting in weak reflection links. All the links are assumed to experience Rician fading with the distance-dependent path-loss.	Single Active-IRS deployed.	Proposed two superposition transmission schemes, namely, the w-DSS and w/o-DSS schemes to enhance the covert communication and sensing performances.
2024	[99]	Enhanced the overall communication throughput, and strengthened the total target sensing power.	Optimization of the transmit beamformer at the BS, the power allocation factors within each cluster, and the phase shifts at the IRS.	Obstructed link between BS and UEs.	Backscatter-enabled hybrid IRS deployed.	Enhanced overall performance through joint optimization and composite distance and angle-based (CDA) and channel-oriented adaptive (COA) algorithm for grouping users into clusters with fixed base station and IRS positions,
2024	[100]	Maximization of Sum secrecy rate.	By optimizing the beamforming vectors of the BS and the phase shifts of IRS under the constraints of total transmit power, communication quality of service, and sensing quality.	With both LoS and reflected paths. It considered quasi-static block fading channels	Single IRS deployed.	The proposed IRS-assisted ISAC-NOMA scheme achieves more than 50% secrecy than that of the ISAC, and this gain grows with power.
2024	[101]	Maximization of the sum secrecy rate, under the constraint of the echo signal requirement towards the target.	Optimization of the transmit jamming and precoding vectors and the phase reflecting matrix.	Presence of Rayleigh faded LoS component. And IRS to UE link is characterized by Rician distribution.	Single IRS deployed.	Improved sum secrecy rate while ensuring the reliable sensing functioning over the OMA based ISAC.
2024	[102]	Maximization of the fairness between communication UEs and the sensed target.	By exploiting the joint optimization of the transmit beamforming vectors of the BS and transmission and reflection coefficient matrices of the STAR-IRS Optimization.	No direct path from the BS to the sensing target and the UEs.	Single STAR-IRS deployed.	Proposed SCA based low-complexity algorithm for joint optimization. The proposed STAR-IRS-NOMA out performs the conventional-IRS-NOMA and Conventional-IRS-OMA in-terms of ISAC fairness.
2024	[103]	Maximization of outage probability, Ergodic rate, system throughput and SINR.	Proposed a framework considering independent homogeneous Poisson point processes (PPP) for spatial arrangement of the NOMA-enabled BSs and UEs.	Obstructed LoS between the BS and UEs and is modeled with Rayleigh-distributed channel. Other paths are characterized by Nakagami-m fading channels.	Active -IRS deployed.	Improved performance over the IRS-OMA system.
2024	[104]	Maximization of the average achievable rate and energy efficiency.	By exploiting the joint optimization of the transmit power allocation, the scheduling of users and targets, the phase shifts at IRS, and the trajectory and velocity of the UAV.	The propagation paths corresponding to all the targets and users are having LoS components and the Doppler frequency shift caused by the movement of the UAV. The UAV act as a BS.	Single IRS deployed.	Improved achievable rate and energy efficiency for an IRS assisted UAV-ISAC networks against a potential eavesdropper with unknown CSI.
2024	[105]	Optimization of the sensing beampattern under the constraints of communication rate.	By exploiting the joint power allocation, active beamforming and IRS phase shift design.	Obstructed LoS path between the BS and communication UE and radar targets.	Single IRS deployed.	Improved minimum beampattern gain (MBPG) in comparison to the existing work.
2024	[106]	Maximization of minimum beampattern gain.	By exploiting the joint optimization of the user power allocation, the active beamforming at BS and the passive beamforming at STAR-RIS under the constrain of minimum requirements for communication and power consumption requirements.	The direct links between the BS to the communication users and radar targets are blocked.	A STAR-IRS empowered full space DL ISAC system.	Proposed a block coordinate descent (BCD) based integral matrix (BCD-M) algorithm and BCD based element-wise (BCD-E) algorithm. The proposed system achieve higher minimum beampattern gain with less mismatch error.
2024	[107]	Optimized balance the communication and localization performance.	Modified CRLB-based beamforming algorithm over using the SNR metric.	Quasi-static block-fading channels with LoS component.	Distributed IRS system	Superior performance of the proposed IRS-aided Non-orthogonal-ISAC system to the IRS aided time-division ISAC system in terms of mutual information and angle estimation.
2023	[108]	Maximization of the uni-cast communication rate at the near user under the target illumination power constraint with perfect and imperfect SIC scenarios.	Exploiting Dinkelbach method to transform the optimization problem into an equivalent one. Afterward, resolved it by utilizing alternating optimization algorithm and semidefinite relaxation (SDR) with Sequential Rank-One Constraint Relaxation (SROCR).	Rayleigh channel in presence of direct and reflected path.	Single IRS deployed.	Improved achievable rate against the system without NOMA with perfect and imperfect SIC.
2023	[109]	Maximization of the minimum radar beampattern gain.	By exploiting the joint optimization of the active beamforming at the BS, power allocation coefficients among NOMA users and passive beamforming at the IRS.	The radar targets are distributed in the NLoS region of the BS and the LoS links are blocked. The IRS scheme is explored to provide virtual LoS links and reflection links for radar sensing and communication system respectively.	Single IRS deployed.	Proposed iterative block coordinate descent (IBCD) algorithm with iterative alternating optimization (IAO) algorithm. The proposed scheme outperforms the IRS assisted ISAC system without NOMA in terms of beampattern gain.
2022	[110]	Maximization of the minimum radar beampattern gain	Joint optimization of the active beamforming, power allocation coefficients and passive beamforming.	The direct links between the BS to the communication users and radar targets are blocked.	Single IRS deployed.	The proposed scheme outperforms the IRS assisted ISAC system without NOMA.

TABLE 8. Comparison between the Algorithms associated with IRS-NOMA aided ISAC.

Algorithms Used	Definition	Method	Drawback
Successive Convex Approximation (SCA)	It is an iterative optimization technique which is used for non-convex problems. The main idea behind SCA is to approximate a non-convex problem by a series of convex problems that are easier to solve.	<p>Initial Problem: Start with a non-convex optimization problem that you want to solve.</p> <p>Convex Approximation: At each iteration, approximate the non-convex function with a convex function, often using first-order Taylor expansion that yields a convex surrogate.</p> <p>Solve the Convex Problem: Solve the resulting convex optimization problem, yielding a solution that, while not optimal for the original non-convex issue, usually improves on the previous iteration.</p> <p>Update and Iterate: Update the parameters on the obtained solution and repeat. Each iteration refines the approximation, ideally converging to a solution for the original non-convex problem.</p> <p>Convergence: In some cases, the SCA method can converge to a non-convex problem's local minimal.</p>	SCA is particularly useful because it transforms complex optimization problems into a series of simpler ones, making them more tractable. However, the quality of the final solution can depend on the choice of the initial approximation and the properties of the problem at hand.
Sequential Rank-One Constraint Relaxation (SRCR)	It is a method for solving non-convex optimization problems, especially with matrix variables. The approach involves: <p>Non-Convex Problems: Many optimization problems, like low-rank matrix approximation, are non-convex and difficult to solve directly.</p> <p>Rank-One Constraints: SRCR iteratively relaxes matrix variables rank constraints, gradually relaxing the fixed rank need to allow a more flexible solution search.</p> <p>Sequential Approach: The algorithm sequentially adds rank-one constraint at each step, guiding the optimization towards feasible solutions that meet the rank criteria.</p> <p>Convex Relaxation: Solving a series of convex problems of an original non-convex problem, SRCR efficiently explores solution space and enhances initial estimates.</p>	<p>Initialization: Start with an initial guess for the matrix variable.</p> <p>Solve Relaxed Problem: Solve a relaxed version of the original problem that may allow for higher rank.</p> <p>Update Constraints: Based on the solution from the previous step, introduce a new rank-one constraint that refines the search space.</p> <p>Iterate: Repeat the process, progressively adding constraints and solving the relaxed problems until convergence criteria are met.</p> <p>Final Solution: Once the iterations converge, the final output is typically a solution that satisfies the desired rank conditions while being optimal with respect to the original problem. The SRCR algorithm leverages the balance between flexibility and structure in optimization, making it a powerful tool for tackling challenging non-convex problems.</p>	<p>Computational Complexity: The computational complexity increases as its steps involve solving complex problems.</p> <p>Convergence Speed: The convergence rate can be slow, particularly if the rank constraints are not effectively managed. In some cases, the algorithm may require many iterations to reach a satisfactory solution.</p> <p>Numerical Stability: The numerical stability of the algorithm can be a concern, especially in cases where matrix operations are involved, potentially leading to inaccuracies or divergence in certain scenarios.</p>
Modified Cramer-Rao Lower Bound (CRLB)	It is a critical tool in estimation theory that extends the classical CRLB to accommodate a broader range of estimation scenarios, providing insights into the limitations of various estimators.	<p>The Modified CRLB is used in contexts where the classical assumptions of unbiasedness do not hold or when dealing with biased estimators. It adapts the original CRLB to account for situations like:</p> <ol style="list-style-type: none"> Nonlinear transformations of parameters. Estimation in the presence of noise or certain constraints. Problems involving multiple parameters or complex models. <p>The Modified CRLB provides a more general bound, often involving adjustments for bias and the structure of the estimator. It allows for a better understanding of the trade-offs between bias and variance in parameter estimation.</p>	<p>Assumptions: The Modified CRLB relies on specific assumptions about the statistical model, like regularity conditions for Fisher information. If these assumptions are not met, the bound may be invalid.</p> <p>Bias Considerations: The Modified CRLB considers biased estimators, precisely detecting the bias and its impact on variance can be complex, making its application challenging.</p> <p>Complexity of Calculation: Deriving the Modified CRLB can be mathematically complex, especially in nonlinear contexts, making practical installation difficult.</p> <p>Local Behavior: The CRLB offers a local bound based on Fisher information at a point, which may not reflect the global behavior of the estimator across the parameter space.</p> <p>Sensitivity to Model Mis-Specification: If the model is mis-specified, the Modified CRLB may give inaccurate insights into estimator performance.</p> <p>Dependence on Parametrization: The bound may vary significantly with different parameter definitions, leading to inconsistencies in interpretation.</p>
Iterative Block Coordinate Descent (IBCD)	The Iterative Block Coordinate Descent (IBCD) algorithm is an optimization technique used for solving problems with a large number of variables, particularly those that can be decomposed into smaller blocks. It's particularly effective in scenarios where the objective function can be expressed as a sum of functions, each depending on a subset of the variables.	<p>Block Coordinate Descent: The basic idea of coordinate descent is to optimize one variable (or a block of variables) while keeping the others fixed. IBCD iteratively repeats for different blocks of variables.</p> <p>Iterative Process: The algorithm proceeds by:</p> <ol style="list-style-type: none"> Dividing the variable set into smaller blocks. Optimize the chosen block and fix other blocks. Update various blocks cyclically and iteratively till convergence. <p>Objective Function: IBCD is often used to minimize an objective function that can be expressed as a sum of functions of different blocks, making it versatile in handling wide objective forms.</p> <p>Convergence: IBCD is guaranteed to converge to a local minimum under specific criteria. Block choice and problem structure direct convergence.</p>	<p>Convergence to Local Minima: In non-convex problems, the algorithm may converge to a local minimum rather than a global one.</p> <p>Choice of Blocks: The performance can be sensitive to how the variable blocks are defined. Poor choices can lead to slow convergence.</p> <p>Non-Uniform Convergence Rates: Depending on the structure of the problem, some blocks may require more iterations than others, leading to inefficient updates.</p>

TABLE 8. (Continued.) Comparison between the Algorithms associated with IRS-NOMA aided ISAC.

Dinkelbach Method and Semidefinite relaxation (SDR) with Sequential Rank-One Constraint Relaxation (SROCR)	The Dinkelbach method is an iterative algorithm used to solve nonlinear fractional programming problems. Semidefinite relaxation (SDR) with Sequential Rank-One Constraint Relaxation (SROCR) is an advanced optimization technique, especially relevant for non-convex problems.	In SDR, we lift the problem by reformulating scalar variables into matrices, typically symmetric positive semidefinite (PSD) matrices. This removes non-convex constraints, like the rank-one condition, making the problem convex and solvable via standard semidefinite programming methods. While SDR offers a convex approximation, the solution obtained is not always of rank one—a desirable property in many applications like beamforming, where optimal solutions are often expected to have this structure. SROCR is a post-processing method applied after SDR to refine the solution and recover a rank-one solution iteratively.	SDR involves lifting the problem to a higher-dimensional matrix space, meaning that if the original problem has n variables, SDR leads to a matrix of size $n \times n$. Solving the semidefinite program (SDP) requires algorithms with complexity $O(n^6)$ for large matrices, making it computationally expensive for high-dimensional problems. SDR + SROCR may become infeasible for real-time applications with strict latency requirements.
With Dedicated Sensing Signal (W-DSS) and Without Dedicated Sensing Signal (W/O-DSS)	In the W-DSS approach, the system transmits a dedicated signal specifically designed for sensing tasks (like radar or environmental detection) alongside communication signals. This signal is optimized to improve sensing performance, such as by enhancing target detection or object localization. In the W/O-DSS approach, the communication signal itself is reused for sensing purposes without transmitting an additional dedicated signal. This approach leverages the existing communication waveform (like OFDM or 5G signals) to perform both communication and sensing tasks.	Key Features of W-DSS: Separate Waveforms: The system allocates resources to communication and sensing signals (e.g., time, frequency, or power). High Sensing Performance: A dedicated sensing waveform can be tailored with properties like low side-lobes or high time-frequency resolution. Coexistence Techniques: Some systems may use time-division multiplexing (TDM) or frequency-division multiplexing (FDM) to separate sensing and communication functions. Key Features of W/O-DSS: Single Signal for Dual Use: A single waveform serves communication and sensing, reducing extra resource needs. Minimal Overhead: No need to allocate additional bandwidth, time, or power for sensing. Signal Reuse: Communication signals like OFDM subcarriers are analyzed for sensing tasks (e.g., object detection, velocity estimation).	W-DSS: Resource Overhead: Using a separate sensing signal consumes additional time, power, or bandwidth. Complex Design: Requires coordination between sensing and communication signals, especially in real-time scenarios. W/O-DSS: Lower Sensing Performance: Communication waveforms are not optimized for sensing, leading to reduced accuracy (e.g., degraded range or Doppler estimation). Interference Management: Communication signals may introduce interference or noise, affecting sensing quality. Signal Design Trade-offs: Optimizing a signal for both communication and sensing can lead to compromises in performance for one or both tasks.
Composite Distance and Angle-based (CDA) and Channel-Oriented Adaptive (COA)	The CDA algorithm optimizes wireless communication by considering both distance and angle of arrival (AoA) of signals between a transmitter and receiver. It uses geometric properties of the communication channel, such as the physical location of users and the propagation angle, to improve performance through beamforming or antenna selection. The COA algorithm dynamically adapts communication parameters based on the instantaneous channel conditions, such as channel gain, noise, or interference levels. This approach is well-suited for fading environments and time-varying channels, commonly seen in mobile networks.	Concept of CDA: 1. Distance-based optimization ensures that users closer to the transmitter receive higher priority or enhanced beamforming gain. 2. Angle-based optimization uses the angle of arrival (AoA) or angle of departure (AoD) to select the best antennas or beams that align with the user's direction, reducing interference and maximizing signal strength. Concept of COA: 1. Instead of relying on static settings, the COA algorithm adapts transmission power, modulation schemes, or beamforming directions in real time to match the changing channel quality. 2. This algorithm leverages channel state information (CSI), such as SNR, channel gain, or fading coefficients, to make optimal decisions for each transmission.	Limitations of CDA Algorithm: High Computational Complexity: Requires real-time computation of distance and angle metrics for multiple users. Dependency on Accurate Location Data: CDA needs precise AoA and user distance information, which may require complex hardware like angle estimation sensors. Limitations of COA Algorithm: Channel Feedback Overhead: Requires frequent feedback of CSI, which increases signaling overhead. Latency Issues: Real-time adaptation can introduce delays, especially if channel conditions change rapidly. Computational Complexity: Continuous monitoring and adaptation require high processing capabilities.
Successive Convex Approximation (SCA) Approach based on the first-order Taylor Expansion and the Second-Order Cone (SOC)	The SCA approach based on the first-order Taylor expansion and SOC is an optimization method widely used in wireless communications and signal processing to solve non-convex problems efficiently. This technique approximates a non-convex function with a sequence of convex subproblems, which are easier to solve. By leveraging both the first-order Taylor expansion and second-order cone programming (SOCP), this method finds locally optimal solutions for problems such as power control, beamforming, and resource allocation.	Problem Setup: The initial optimization problem may have a non-convex objective or constraints. The aim is to transform it into a series of convex subproblems that are easier to solve. First-Order Approximation: Each iteration uses a first-order Taylor expansion over the current solution to approximate the objective or constraints x^k . Convex Reformulation Using SOCP: The linearized constraints or quadratic functions are expressed as SOC constraints, which can be efficiently solved using SOCP solvers. Update and Iterate: The solution from the convex subproblem is used as the starting point for the next iteration. The process continues until convergence.	Local Optimality Only: Since the approach is based on local approximations, it may converge to a local optimum instead of the global optimum. Computational Complexity: Each iteration involves solving an SOCP, which can be computationally intensive for large-scale problems. Requires Good Initialization: The performance of SCA depends on the initial point, as a poor starting point may lead to slow convergence or suboptimal solutions.
Block Coordinate Descent (BCD)-based Integral Matrix	The BCD-based integral matrix algorithm is an iterative optimization method designed to solve non-convex problems involving integral (discrete) variables and large-scale matrices. BCD is widely used in wireless communications, machine learning, and signal processing, especially when the optimization problem involves multiple coupled variables or matrix structures that can be decomposed into smaller subproblems (blocks).	Integral Matrix Representation: BCD splits an integral matrix into blocks or sub-matrices in order to optimize it. Iterative Optimization: At every stage, every sub-matrix is optimized uniquely. This makes the problem more manageable and allows for simpler computations in each block. Convergence: Every block proceeds with this process repeatedly until the overall matrix optimization meets a stopping need, like minimal change between iterations or a maximum number of iterations.	Local Convergence: BCD generally converges to a local optimum, as it only optimizes one block at a time. Rounding Errors (in Integer Problems): When applying convex relaxation, rounding can introduce errors or suboptimal solutions. Slow Convergence: Convergence can be slow, especially if the blocks are highly interdependent.

The author suggest a low-complexity alternating optimization (AO) approach to solve the non-convex problem with a non-smooth objective function. The outcomes of the simulation show that the suggested algorithm is efficient in raising the minimum beampattern gain (MBPG) in comparison to alternative baselines. Furthermore, the simulation results are used to analyze and show the trade-off between sensing and communication. Motivated by its potential, the authors in [106] suggest a novel full-space ISAC framework that benefits from NOAM. By utilizing STAR-IRS to expand half-space into full-space ISAC coverage, the competition for wireless resources becomes more fierce. To lessen this competition and ensure ISAC performance, cluster-based NOMA (CB-NOMA) is used to conserve combined communication and sensing beams. Moreover, in addition to separate sensing beams, combined beams support radio sensing functions. A BCD-based element-wise technique is suggested to further minimize the complexity of passive BF design by optimizing the combined phase shift and amplitude coefficients of each STAR-IRS element individually. Furthermore, in [102], the authors investigate the fairness of ISAC systems that have been improved by STAR-IRS and NOMA in order to remove interference from sensing signals before decoding communication signals. The objective is to maximize fairness between communication users and the sensing target by jointly building the STAR-IRS coefficient matrices and BS transmit beamforming vectors. By determining the optimal transmit beamforming vectors and STAR-IRS coefficient matrices, the authors propose a low-complexity solution based on semidefinite programming (SDP) and sequential convex approximation (SCA) techniques to solve this challenging optimization problem. Based on simulation results, the proposed STAR-IRS-NOMA assisted ISAC system performs more fairly than the conventional IRS-NOMA and IRS-OMA assisted ISAC systems. This research [104] examines secure transmission in UAV-ISAC networks with the assistance of IRS. Serving multiple communication UEs and providing IRS support for the detection of several targets, the UAV serves as a dual-purpose ISAC BS. An eavesdropper using an unknown channel and state information attempts to intercept confidential data sent from the UAV to UEs. By optimizing UE and target scheduling, IRS phase shifts, UAV trajectory and velocity, and transmit power allocation simultaneously, the suggested secure transmission technique aims to maximize the average attainable rate. The authors in [103] explore the possibility of integrating IRS, MIMO, NOMA and ISAC for a range of Internet of Things (IoT) applications with the introduction of 6G communication. When integrating ISAC into a MIMO heterogeneous network (HetNets), it is required to reevaluate the network's performance, particularly in terms of ergodic rates and outage probability. This work presents a novel analytical tool to evaluate downlink transmissions in MIMO HetNets. Using independent homogeneous Poisson point processes (PPP), it predicts the spatial arrangement of users and base stations (BSs) with NOMA capabilities. This research derives approximations for beampattern, system

throughput, and ergodic rates in terms of sensor performance. Through the work in [101], the authors suggest that IRS-assisted secure transmission technique maximizes the cumulative secrecy rate while satisfying the target's echo signal requirement by simultaneously optimizing jamming, active transmit precoding at the BS, and passive phase reflecting at the IRS. In [100], the authors have introduced a framework to enhance target recognition and secure communication, this research describes the usage of IRS in an ISAC system assisted by NOMA. The technique simultaneously propagates radar and NOMA signals via reflected and direct links. A secure optimization problem arises when the beamforming vectors and RIS phase shifts of the base station are jointly developed while considering constraints on total transmit power, communication quality of service, and sensing quality. The simulation's findings demonstrate that the recommended approach significantly enhances secure communication and precise target identification. In [99], the researchers examine the performance of a hybrid-IRS-NOMA network with backscattering capabilities in order to enable ISAC. Increasing sensor power for target detection and enhancing overall communication throughput are the main objectives. To achieve these objectives, two novel dynamic user clustering algorithms are proposed: channel-oriented adaptive (COA) and composite distance and angle-based (CDA). These techniques leverage successive interference cancellation (SIC) to enable efficient communication between every pair of UEs with fixed placements for the BS and RIS. The work presents a broad optimization problem with the twin objectives of maximizing the sum rate and sensing power. For this, it is necessary to optimize the transmit beamformer at the BS, phase shifts at the IRS, and power distribution factors within each cluster. It proposed a novel iterative method based on successive convex approximation (SCA) and alternating optimization (AO) is proposed. In order to maximize the covert rate in an ISAC wireless system inspired by NOMA, this paper [124] makes use of active IRS to improve covert communications. In the presence of a warden, a dual-function BS sends a superposition signal to perceive numerous targets while guaranteeing secure and reliable covert communications for both public and covert NOMA users. The transmission beamforming at the BS and the reflection beamforming at the active-IR are jointly optimized to achieve the maximum covert rate, taking into account the covertness level against the warden, the Cramér-Rao bound constraint for multi-target estimations, and the quality-of-service (QoS) requirements of the NOMA public UE. Two superposition transmission systems are examined: w-DSS, which has a specific sensing signal, and w/o-DSS, which does not (w-DSS). For both schemes, the optimization problems for joint transmission and reflection beamforming are developed and presented in this paper. The numerical findings show that in terms of covert rate and the trade-off between sensing performance metrics and covert communication, the active-IRS-aided ISAC-NOMA system performs better than its counterparts

with and without IRS. Additionally, by allocating greater transmit power for covert transmissions while preserving similar multi-target sensing capabilities, the w/o-DSS method delivers a higher covert rate compared to the w-DSS strategy. A comparative analysis between the related works is presented in Table 7. And also in Table 8, we have presented a comparison between different associated algorithms.

VI. INTERPLAY BETWEEN IRS-NOMA ASSISTED ISAC AND OTHER EMERGING TECHNOLOGIES

The section highlights the possible application scenario for the IRS assisted ISAC-NOMA for 6G. Figure 17 illustrates some application scenarios in which IRS-NOMA-assisted ISAC can be efficiently utilized to realize next-generation wireless communication networks.

A. UAV-BORNE IRS WITH ISAC-NOMA

Non-Terrestrial Network (NTN) technology such as UAVs, high-altitude platform stations (HAPS), and satellites improve the coverage and performance of Integrated Sensing and Communication (ISAC) systems. This is largely owing to their mobility and the robust line-of-sight (LoS) links that connect the air and ground. Furthermore, NTN supports cooperative sensing and target identification, allowing for the fusion of sensing data from several platforms, hence increasing the effectiveness of both communication and sensing capabilities. Although such networks face numerous challenges, including UAV trajectory optimization, power constraints, inter-beam interference, high RF chain energy consumption, and location estimation errors, these issues must be addressed effectively to ensure optimal performance. These challenges can be effectively addressed by through the utilization of IRS and NOMA. By ISAC with NOMA, this setup optimizes resource allocation, improves spectral efficiency, and extends coverage. The UAV's mobility allows dynamic IRS positioning, while NOMA enhances user multiplexing, making the system more flexible and efficient for various applications like surveillance, disaster management, and 5G networks. It also opens up new opportunities to enhance the performance of the ISAC system by effectively integrating UAVs, IRS, and NOMA through the joint optimization of UAV trajectory, power allocation, IRS deployment, and IRS phase configuration.

B. IRS ASSISTED ISAC-NOMA (MMWAVE/THZ)

IRS with ISAC using NOMA in mmWave and THz bands offers potential for high communication rates and precise sensing resolution due to their broad bandwidth and narrow-focused beams. Implementing ISAC in these bands presents issues such as near-field beamforming, range-dependent bandwidth, and the necessity for particular channel models [125]. Wide bands in mmWave/THz systems can cause beam squint, leading to signal deviations from intended directions. The high path loss at these frequencies requires precise IRS placement and enhanced reflective capabilities, making design and deployment complex. Moreover the

effective channel estimation is challenging due to dynamic environments and high-frequency fading, demanding sophisticated algorithms for reliable performance. Apart from all these challenges interference management, security in the high-frequency spectrum are also some critical concerns. Furthermore, ISAC systems need immense power for communication and sensing, particularly at high-frequency bands like mmWave as well as terahertz (THz). Engineering hardware with the ability to properly regulate power usage while retaining functionality is a vital task. Handling such hardware impairment challenges is pivotal towards the fruitful creation and installation of ISAC mechanisms, which permit the incorporation of sensing as well as communication abilities for aiding elegant applications in a wide range of sectors [126], [127].

It is expected that ultra-massive MIMO, which is more feasible at higher frequencies, would increase the range of both sensing along with communication while enabling more IoT devices with more spatial flexibility. Nevertheless, ultra massive MIMO's actual deployment was hampered by its immense complexity as well as the signal processing it needed. With the goal to achieve ultra massive MIMO at minimal complexities of hardware along with expense, meta-surface antennas featuring meta elements of continuous or discrete are currently attracting a lot of interest [128], [129]. Further, it is believed that directly regulated meta-surface antennas are going to be able to sense the holographic picture of neighbouring IoT gadgets at higher new frequencies as well as enable holographic beamforming along with modulation. Feeding and controlling meta-surface antennas to build several beams for various missions, notably sensing as well as communication, along with perceiving their surroundings would be a challenging yet fascinating area of study in this regard. Researchers additionally feel that deep learning along with ML are essential for effectively controlling the meta-surface and interpreting the holographic picture that the antennas are perceiving [130]. Overcoming these issues is crucial for robust 6G networks. Thus there are tremendous scopes for the researchers to improve the ISAC.

C. STAR-IRS WITH ISAC-NOMA

The combination of Simultaneous Transmitting and Reflecting (STAR)-IRS and ISAC with NOMA (ISAC-NOMA) represents a promising approach to next-generation wireless networks. STAR-RIS can dynamically modify transmission and reflection coefficients, resulting in flexible, multi-functional surfaces with optimal signal coverage. When used with ISAC-NOMA, which integrates communication and sensing capabilities while maximizing spectrum utilization, it improves connection and environmental awareness. This collaboration enables low-latency, high-capacity networking and precise sensing, and energy efficiency improvement which are essential for applications like smart cities and self-driving cars. Together, STAR-RIS and ISAC-NOMA

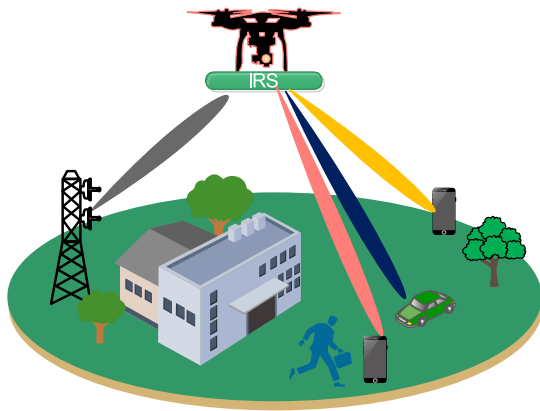

(a) UAV-Borne IRS with ISAC-NOMA

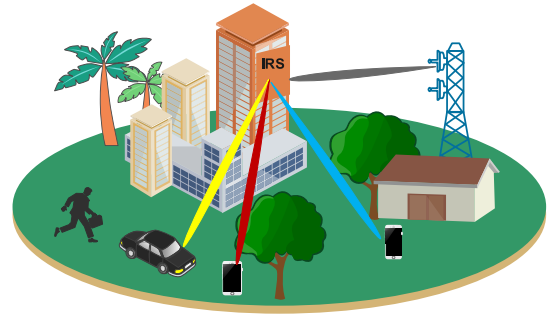

(b) IRS assisted ISAC-NOMA (mmWave/THz)

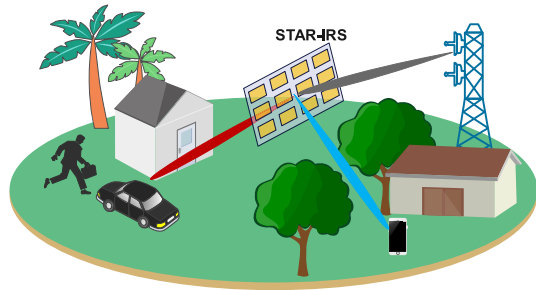

(c) STAR-IRS with ISAC-NOMA

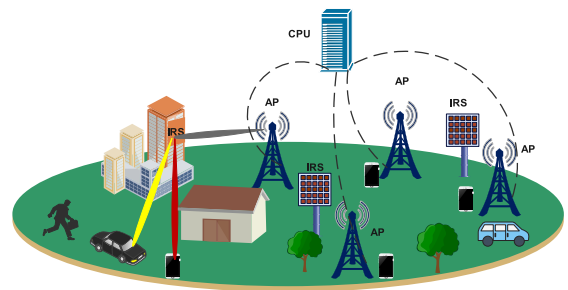

(d) IRS aided CF NOMA for ISAC

FIGURE 17. Application of IRS assisted ISAC-NOMA in the framework of 6G enabling technologies.

increase network efficiency, user capacity, and environmental flexibility.

STAR-IRS with ISAC-NOMA poses distinct challenges. First, efficient channel estimate for STAR-IRS is difficult because it must maximize/optimize both transmission and reflection for multiple users. Second, minimization of interference in ISAC-NOMA with STAR-IRS is difficult due to simultaneous sensing and communication in a shared spectrum, demanding advanced interference cancellation algorithms. Furthermore, developing energy-efficient algorithms for the dense STAR-IRS configuration and assuring low-latency, real-time processing necessitate significant computational resources. Finally, physical security and privacy concerns arise, as STAR-IRS may unintentionally increase eavesdropping risks in open communication settings.

D. IRS AIDED CF-MMIMO NOMA FOR ISAC

Cell-free (CF) [131] mMIMO with IRS and NOMA is a cutting-edge approach in ISAC systems. This architecture enhances spectral efficiency and coverage by distributing antennas across a wide area, rather than concentrating them in a single cell. ISAC implementation can benefit from cell-free MIMO networks, which include several distributed access points. However, the successful implementation of

ISAC requires cooperative design and resource allocation optimization. A key challenge in ISAC systems is the need to manage the trade-off between sensing and communication performance due to the shared resources—time, frequency, power, and spatial dimensions. This complexity increases in ISAC massive MIMO cell-free architectures that employ joint transmission and joint reception techniques. However, this trade-off can be effectively addressed by utilizing existing communication signals for sensing tasks or by incorporating sensing signals while maintaining desired communication performance levels. Although significant advancements have been made in this area, there remains a critical demand for innovative processing and resource allocation strategies that can simultaneously fulfill the requirements of both communication and sensing. Continued research and development in these areas are essential for optimizing the functionality and efficiency of future ISAC systems.

Furthermore, a comparative analysis is presented in Table 9, highlighting various design approaches, performance evaluation metrics, and associated challenges.

VII. CHALLENGES AND FUTURE PERSPECTIVES

In the current section, authors have highlighted challenges as well as several relevant studies for future perspectives.

TABLE 9. Different IRS-NOMA approaches within ISAC systems.

Approach	Objective	Design Approach	Performance Metrics	Challenges
UAV-Borne IRS with ISAC-NOMA	<ul style="list-style-type: none"> Optimization of the average achievable rate. Energy efficiency maximization. Extension of coverage area. Enhancement of sum secrecy rate. Communication secrecy rate optimization. Maximization of the weighted sum of average sum rate. Average sensing SNR maximization. Sensing performance enhancement. 	<ul style="list-style-type: none"> Transmit power allocation enhancement. Scheduling of communication users and targets. Maximization of IRS phase shift. UAV's trajectory optimization. UAV's velocity optimization. Enhancement of UAV acceleration. IRS-UAV deployment optimization. Artificial noise (AN) power maximization. Optimization of transmit beamforming. UAV receive beamforming improvement. Dual-function radar-communication beamforming (DFRC-BF) optimization. 	<ul style="list-style-type: none"> Average Achievable Rate. Average Sum Rate. Energy Efficiency. Sum Secrecy Rate. Normalized Beampattern Gain. Achievable Average Sum Rate. Average Sensing SINR. Angle Estimation. 	<ul style="list-style-type: none"> UAV's optimized trajectory uses additional energy, which reduces energy efficiency. Increasing the SNR threshold shrinks the sum secrecy rate. Sensing performance improvement will sacrifice the secrecy rate of the system. Enhancing channel power gain decreases average sensing SNR. As jamming signal power increases, received sensing SNR decreases. Jamming signal power rises, sum rate becomes lower.
STAR-IRS with ISAC-NOMA	<ul style="list-style-type: none"> Maximization of the sum secrecy rate. Minimum beampattern gain maximization. Satisfying communication and power consumption needs. Matching error minimization. Optimizing communication user's minimum rate needs. Maximization of the minimum of the SINR. Minimum of the SCNR optimization. Enhancement of fairness across sensing targets and communication users. 	<ul style="list-style-type: none"> Transmit beamforming vector optimization. Optimization of artificial jamming. Maximization of STAR-IRS passive transmission. Reflection beamforming vector optimization of STAR-IRS. User power allocation factors maximization. Enhancing time allocation variables. STAR-IRS coefficient matrix optimization. Optimizing the STAR-IRS passive beamforming. 	<ul style="list-style-type: none"> Achievable Rate. Sum Secrecy Rate. The minimum Beampattern Gain. Amplitude Adjustment Coefficient. Matching Error. ISAC Fairness between Communication Users. ISAC Fairness between Sensing Targets. Mutual Information. 	<ul style="list-style-type: none"> Stricter beampattern gain results in reduced sum secrecy rate. Higher beampattern gain directs more power towards target and lowers transmission rate. Minimum beampattern gain drop as sensing target numbers rose. Sensing target directly isn't ideal for STAR-IRS. Rosed transfer phase-shift coefficients complex passive beamforming design. STAR-IRS's passive design raises reflection's coefficient, challenging passive beamforming design.
IRS-aided Cell-Free (CF) NOMA for ISAC	<ul style="list-style-type: none"> Maximization of minimum spectral efficiency (SE). Enhancement of sensing mainlobe-to-average-sidelobe ratio (MASR). Minimization of sensing beampattern matching mean square error (MSE). Maximization of sum rate/communication rate. Sum of sensing SINR maximization. Sensing beampattern gain enhancement. Location error rate (LER) optimization. Detection probability maximization. 	<ul style="list-style-type: none"> Access point (AP) operation mode selection design. AP power control design. Uplink pilot training. Pilot allocation optimization. Target AP pairing. Transmit beamforming optimization. Optimization of IRS phase shift. Optimizing power budget of the network. Joint information optimization. 	<ul style="list-style-type: none"> Average Minimum SE. Sensing Beampattern. Sum Rate. Amount of Transmit Data. Sum of Sensing SINR. Average Running Time. Beampattern Gain. The Sum of Communication Rate. Sensing Localization Estimation Rate. Detection Probability. 	<ul style="list-style-type: none"> Achievable downlink SE drops as AP number shrinks. The amount of transmit data declines as pilot sequence rises. Sensing performance shrinks as communication SINR needs roses. As the number of users grows, sensing performance declines. As AP increases, the memory usage of all methods also increases. Smaller relative communication symbols, leading to poorer communication performance. As the communication SINR threshold rises, the detection performance shrinks.
IRS-assisted ISAC-NOMA (mmWave/THz)	<ul style="list-style-type: none"> Sum rate maximization. Optimization of sensing power. Enhancing secure communication. Enhancement of sensing capabilities. Maximization of sum secrecy rate. Optimization of outage probability. Maximization of ergodic rate. System throughput optimization. Maximization of minimum radar beampattern gain. Unicast rate maximization. Optimization of minimum target illumination power. 	<ul style="list-style-type: none"> Optimizing active/transmit beamforming. Power allocation factors within each cluster optimization. IRS phase shift optimization. Optimizing transmit jamming. Optimizing target power budget. Target illumination power optimizing. Optimizing power allocation coefficient. 	<ul style="list-style-type: none"> Average Sum Rate. Total Sensing Power. Achievable Sum Secrecy Rate/Secrecy Rate of Users. Data Rate/System Throughput. Normalized/Minimum Beampattern Gain. Transmit Power. Optimized Rate. Outage Probability. Ergodic Rate. BS Received SINR. Angle Estimation for Localization. Mutual Information. Illumination Power. 	<ul style="list-style-type: none"> Average sum rate shrinks due to added inter-cluster interference. As normalized parameter rises, total sensing power drops. Added inner-cluster/backscatter noise declines average sum rate. Sum secrecy rate level-off and drops as antenna numbers rise. Jamming signal threshold rate rise declines user transfer rates. Ergodic rate drops when the number of IRS elements rises. Efficacy drops if angle across IRS and target is wrongly estimated. Strict communication needs result in sensing performance decline. Minimum beampattern gain shrinks as transmit power drops.

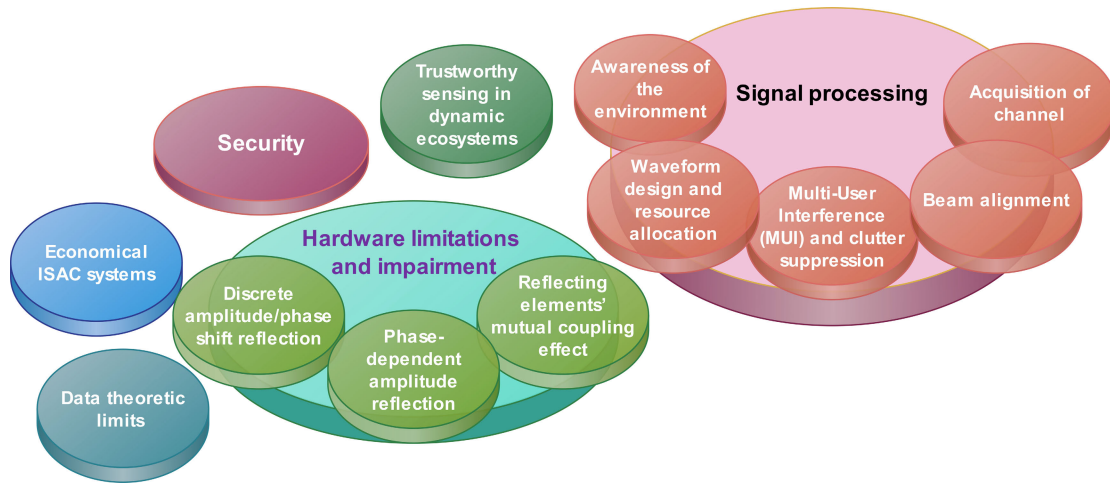

FIGURE 18. Challenges.

A. CHALLENGES

Sensing offerings that employ transmission waveforms for sensing as well as utilizing ubiquitous internet connections offer the potential to constitute a fundamental feature of the forthcoming wireless communications systems. But multiple challenges, as presented in Figure 18 must be overcome.

1) SECURITY CONCERN ASSOCIATED WITH IRS-NOMA IN ISAC

When IRS-NOMA is installed in ISAC, it makes the system notable much better at detecting targets, mitigating interference, and working over a wider range of frequencies [132], [133]. Target parameter interference mitigation as well as non-line-of-sight (NLoS) target identification are enhanced by IRS-NOMA-assisted ISAC. Interestingly, IRS-NOMA-aided ISAC is highly susceptible to eavesdropping and jamming interventions since air-ground channels for communication have been dominated by LoS. Security problems arise with wireless transmission because of the broadcasting nature of the medium. This also brings to light the problem of safely transferring information in the IRS-NOMA-aided ISAC systems. The literature has a number of papers on physical layer security (PLS) for IRS and NOMA systems [134], [135], [136], [137]. Therefore, there is a lot of opportunity to investigate whether it will be feasible to keep information security while putting the IRS-NOMA-aided ISAC systems into operation. Furthermore, non-authorized and malignant UAVs deliver fresh threats to ISAC systems of communication [137], [138].

The installation of IRS-NOMA in ISAC systems has revealed encouraging outcomes since it could establish virtual LoS paths to enable sensing along with communication, hence augmenting capacity. Whereas a number of earlier studies [139], [140], [141] examined the significance of IRS-NOMA in ISAC along with its capability to improve target sensing capabilities, the majority of these studies

made the assumption that the target could not intercept the transmitting signals. The transmitted signal in ISAC systems includes communication and sensing signals that are vulnerable to interception by strangers. Moreover, authors of [142] built a PLS framework and phrased the optimization issue as fractional programming (FP) for minimizing the SINR at the radar targets as well as for maximizing the secrecy rate in the ISAC system via artificial noise (AN) at the transmitting nodes. The numerical findings showed that, even if the greatest secrecy rate was attained, the model assumed that the target's exact position and perfect CSI were both known at BS. Because of this, PLS strategies created for the conventional ISAC systems are worthless when IRS-NOMA is present [137], [143]. Hence, it can be challenging to acquire current IRS-NOMA-assisted ISAC systems for mobile future-generation networks, including the upcoming THz and mmWave connections, due to the rising risk of security breaches via eavesdroppers or non-authorized users.

2) ISAC SIGNAL PROCESSING COMPLEXITIES

Significant real-world signal processing complexities emerge when IRS-NOMA is implemented into ISAC systems. These challenges include multi-path signal integration via IRS-NOMA, tackling clutter through IRS-NOMA-aided links, estimating channels for the additional signal paths introduced by IRS-NOMA, designing waveforms and allocating resources considering IRS-NOMA deployment into account, and resolving the complex computational issues of jointly optimizing IRS-NOMA parameter values.

a: AWARENESS OF THE ENVIRONMENT

For mitigating target-linked ambiguity, precise sensing efficiency advantages arise from preexisting awareness of the environment. For example, in order for the transmitter of DFRC to produce precise beams targeting IRS, the IRS's geolocation needs to be traceable [38], [144]. When

DFRC and IRS are both fixed, this is intuitive, but in a mobile circumstance, it becomes complicated. These applications comprise IRS-installed UAVs and vehicles with DFRCs. In order to regulate the IRS and determine if the received signals are NLoS or LoS, the DFRC employs the use of the scene's geometry [145]. Additionally, prior to tracking operations, the target position knowledge has to be obtained. Hence, in order to estimate the target directions, the DFRC ought to initially employ DF strategies (like MUSIC (Multiple Signal Classification)) [146].

b: WAVEFORM DESIGN AND RESOURCE ALLOCATION

One of the foremost really challenging signal processing problems in ISAC is waveform design and allocating resources, as both sensing and communication capabilities must be incorporated together. The allocation of resources in DFRC layout is being carried out in several transmission methods without the assistance of IRS-NOMA, notably entirely unified (communication-centric, sensing-centric, or hybrid layout) or non-overlapping (frequency/time/code division/spatial multiplexing) structures [5]. The newly developed strategies have assured both sensing and communication performance but come with increased hardware and signal processing complexity, whereas the older strategies were simpler for implementing but resulted in reduced system efficiency. However, ISAC's primary objective is to develop a single waveform believed to handle communication and sensing duties while simultaneously tackling clutter and mitigating interference. In this scenario, the waveform design gets much more challenging when IRS-NOMA techniques are integrated into ISAC [147].

The majority of research into hybrid sensing and communication design is focused mainly upon hybrid waveform design. The most significant challenge with hybrid waveform design revolves around the conflicting key performance metrics (KPMs) for communications and sensing. For instance, the major goal to feed communications is to optimize spectral efficiency, whereas the optimal waveform design to acquire sensing is to estimate resolution along with precision. As Cyclic shift (CS)-Orthogonal frequency-division multiplexing (OFDM) has proved to function as an excellent substitute for communication, numerous investigators have examined using it for sensing as well [64]. On the other hand, the waveform of frequency modulated continuous wave (FMCW) that was originally employed in radar is incapable of transmitting data at the speed of transmission needed for communication services. Several researchers suggested tweaking the waveform of FMCW to make it more friendly for communication. Apart from the numerous advances in this specific field of research, the authors of [148] have suggested employing up-chirp for communication along with down-chirp for radar, as well as the authors of [149] have launched the modulation of trapezoidal frequency modulation continuous-wave (TFMCW), which multiplexes the communication along with radar cycles in the time

domain. Moreover, such strategies may efficiently multiplex data from communication into sensing signals; they typically exhibit lower spectral efficiency because of the presence of chirp-like signals.

c: MULTI-USER INTERFERENCE (MUI) AND CLUTTER SUPPRESSION

In the communication environment, MUI presents a challenge, while in radar back-scatter, the problem often arises from clutter or reflections off unintended objects like the ground, vehicles, buildings, and vegetation. IRS-NOMA can be beneficial in cluttered conditions because it creates an extra LoS path, which optimizes effectiveness when the target is obstructed, particularly within indoor applications for sensing [145], [150]. The covariance matrix of clutter, which needs an earlier understanding regarding the clutter, may be used to mitigate the clutter's effect via taking advantage of the signal dependency of the clutter interference. Moreover, in the IRS-NOMA-aided ISAC circumstance, the BS may efficiently mitigate the clutter through the transmission of a specific sensing signal [151]. A further challenging situation could involve prioritizing the targets identified or monitored through the similar IRS-NOMA system. Addressing this problem might need earlier awareness of the radar environment so that the DFRC system beforehand can prioritize targets and allocate resources to radar appropriately [147].

d: ACQUISITION OF CHANNEL

In wireless communications, the CSI is estimated to enhance the efficiency of data transmission. Unlike traditional massive MIMO systems, IRS-NOMA-aided designs need the estimation of several channel links, including BS-IRS-NOMA and IRS-NOMA-user connections. The integrated processing regarding messages from users alongside radar back-scatter renders the channel estimate for IRS-NOMA-aided ISAC drastically more challenging. Furthermore, pilot communication signals are conveyed to users in order to estimate CSI, whereas omnidirectional probing signals typically get delivered by radars in order to look for potential targets. Radar probing signals might be utilized as pilot signals to fix problems. With the estimated CSI being sent back to the BS, this enables the users to receive the pilot signals via IRS-NOMA [145]. However, a consistent waveform for sensing along with communication which accounts for clutter and interference is a vital ISAC characteristic. In this regard, the designing of waveform problem becomes exceedingly challenging when the IRS-NOMA techniques are assigned to the ISAC.

e: HYBRID RADAR AND COMMUNICATION ASSISTED CHANNEL ESTIMATION ALONG WITH BEAM ALIGNMENT

As a consequence of the rapid evolution of channels for communication along with the large scale of massive MIMO antennas, channel estimation continues to be an insurmountable challenge. CSI needs to be updated on a

regular basis. Hence, the total expense of channel estimate along with CSI transmission is likely to be extremely high, resulting in an enormous challenge of declining efficiency of the spectrum [152], [153]. Hybrid radar and communication strategies might accomplish reciprocal channel estimates via leveraging MIMO antennas along with multi-carrier signals. Additionally, the propagation properties of radar and communication electromagnetic waves are comparable [154]. The radar functionality may estimate communication channels by analyzing motion characteristics along with raw echo on the array antenna. This data includes arrival degree as well as latency/time delay. For attaining the necessary faster rate of data within high-mobility settings, training-reliant sweeping of beam is presently regarded as the major strategy. But, this strategy has substantial overhead because to the constant beam training needed [155].

3) CREATING ECONOMICAL ISAC SYSTEMS FOR DISTINCT APPLICATIONS

ISAC technologies are distinct, and their use cases have varying expectations of performance for sensing precision with communication quality of service. In order to evaluate distinct systems along with techniques under the ISAC framework, performance metrics derived from communication as well as sensing technologies must be examined. Within wireless connectivity, the objective aims to provide an uninterrupted experience for users irrespective of ambient conditions; hence, peak and average data rates, along with latency, must be maintained across distinct link densities of devices per square kilometre, accessibility of kilometres per hour, as well as traffic capability of an area of megabits per second per square metre. The primary objective of RF sensing is to identify, discover, or trace a number of objects with high precision, regardless of ambient conditions. For instance, within industrial IoT circumstances wherein a robot must do highly dependable along with precise operations of sub-centimetre-level precision with millisecond single-dire latency as well as up to 99.9999 % dependability could possibly be needed [23], [156]. Supporting ultra-low latency, extremely dependable, yet accurate industrialized applications poses a challenge for ISAC architecture. With restricted resources, creating an economical ISAC that meets expectations of performance by combining its communication as well as sensing features presents novel challenges for system architecture along with implementation. For that purpose, several key areas of research encompass boosting efficiency through cross-layer as well as cross-component architecture and exploring high-fidelity channel as well as destination models to aid system architecture [157].

4) ATTAINING UNIVERSAL AND TRUSTWORTHY SENSING IN DYNAMIC ECOSYSTEMS

Sensing in the current investigation is usually performed in a single ecosystem using an unvarying setting of geometric. Hence, a variety of parameters may exert a major impact on

the performance of sensing, including the relative distance among the intended object and transmitters or receivers, the quantity of objects within the region, along with the RF waveforms utilized for sensing. Additionally, the reciprocal influence along with backing among sensing as well as communication are not well-explored. Therefore, it is imperative to employ joint sensing, communication-aided sensing, and sensing-aided communication for optimizing the system, attain satisfactory implementation gain, as well as establish a sensing ecosystem with SDN along with dispersed edge computing for attaining universal and trustworthy sensing in dynamic ecosystems [157].

5) DATA THEORETIC LIMITS FOR LOOP SHIFTING ISAC CHANNELS

In most experimental real-world scenarios, channels as well as sensing modes tend to be loop-shifting, meaning they stay fixed across a single standard phrase and are not independent and identically distributed (i.i.d.). Evidently, there is currently little research on the basic constraints of loop-shifting ISAC channels. A significant challenge in illustrating the capability deformation zone for the loop-shifting ISAC channel occurs as below. Under a conventional communication setting, the loop-shifting ISAC channel transforms into a loop-fading channel. For that instance, the area of Shannon's capacity has been clearly established, assuming perfect channel state information at the transmitter (CSIT). Nevertheless, with loop-shifting ISAC channels, assuming flawless CSI might not be realistic, particularly wherever the communication channel also serves as the sensing channel. Through self-sensing, the carrier/transmitter might receive only an imperfect CSIT or CSI response by its recipient. This necessitates accounting for the expenses of CSIT recuperation or state sensing, as well as the consequences of imperfect CSIT, while evaluating the area of capability deformation, which is quite challenging. In reality, with imperfect CSIT, Shannon's capacity might not be accurately characterized. Consequently, the loop-shifting ISAC channels of capability deformation have to be investigated further [61].

6) ISAC HARDWARE LIMITATIONS AND IMPAIRMENT

Among those, the most significant challenge to the effective deployment of the IRS-assisted ISAC system is hardware impairment [126]. In real-world hardware constraints might influence sensors along with communication effectiveness as well as transmission security [127]. Processing in real time for sensing and communication activities is critical. It necessitates incredibly effective and low-delay hardware layouts capable of handling large data workloads. Matching the functionality needs of sensing and communication may be challenging. Highly efficient sensing might require different hardware features than communication at high speed. The hardware convergence technique enables reciprocal sensing and communication, enabling compensation as well as distortion calibration. Figure 19 depicts frequent hardware impairments in the ISAC transmission system.

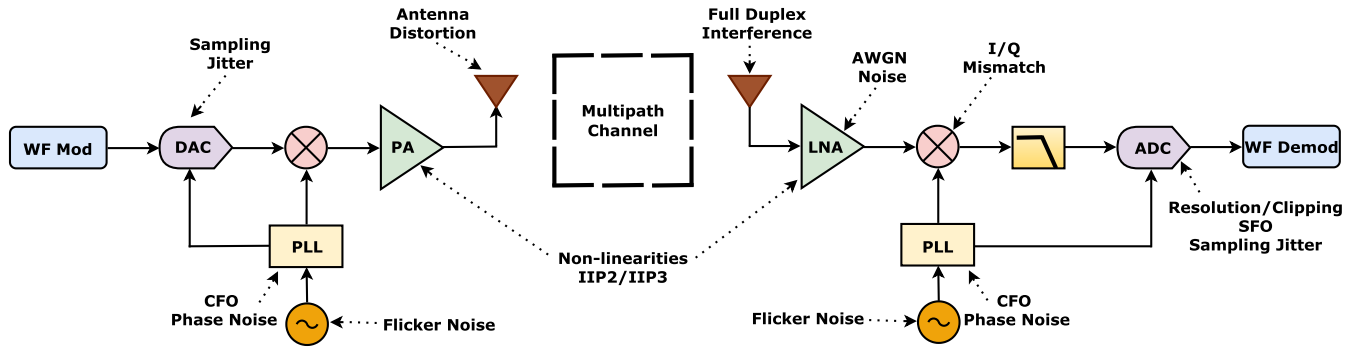

FIGURE 19. Hardware impairments in the ISAC transmission system.

The sensing and communication effectiveness, as well as the transmitting security, may be jeopardized by the practical implementation challenges with IRS-NOMA in ISAC systems in real-world or practical scenarios due to hardware limitations. In ISAC systems, IRS-NOMA is vulnerable to a number of hardware limitations and practical imperfections that might restrict their ability to reflect signals. These include the discrete amplitude/phase shift reflection and phase-dependent amplitude reflection, along with their mutual coupling effect. It has sparked significant efforts to research currently to examine the passive beamforming and practical IRS channel estimation architectures liable to various hardware limitations and imperfections, which will be addressed.

a: DISCRETE AMPLITUDE/PHASE SHIFT REFLECTION

It is practically challenging to achieve the ideal IRS-NOMA reflection model that features frequently flexible/tweakable amplitude or phase shift, regardless of the fact that it proves ideal for optimization as well as offers helpful performance bounds. This is because developing high-resolution amplitude or phase shift controllers is quite expensive. Since every element merely requires a few control bits, it is more economical to implement the IRS-NOMA with discrete along with finite amplitude or phase shift levels, like two level (0 - π) phase shift control or two level (absorbing or reflecting) amplitude control. In order to minimize the channel estimation error, a near-orthogonal discrete Fourier transform (DFT)-Hadamard-reliant reflection matrix for training had been built via appropriate quantization strategies in [158] and [159], which examined the IRS-NOMA distributed channel estimation challenge pursuant to the limitation of IRS-NOMA discrete phase shifts. Afterwards, this research evolved in [160], where the authors refined the original DFT-Hadamard-reliant reflection matrix for training to reduce channel estimate error via the element-wise Block Coordinate Descent (BCD) optimization strategy.

Apart from this, a simple method for maximizing communication efficacy in the IRS-NOMA passive beamforming architecture with discrete phase shifts is to thoroughly search through every phase shift level. For IRS-NOMA featuring

high-resolution phase shifts along with increased reflecting elements, that might result in an unreasonably complex computational environment [161]. In [162] and [163], the branch and bound strategy has been employed to provide a high-quality sub-optimal solution along with a lower average computational complexity; nevertheless, in the worst scenario, exponential complexity is still incurred. Through first solving the approximation issue via relaxed continuous phase limitations afterward employing the next-best phase quantization strategy onto the optimized phase shifts, the relax and quantize methodology had been suggested in [158] and [162] for designing sub-optimal IRS-NOMA reflections, further reducing the complexity. However, this strategy could lose performance due to round-off errors, particularly if every phase shift has a low resolution.

b: MUTUAL COUPLING EFFECT OF REFLECTING ELEMENTS

The mutual coupling effect, in which every single element's impedance is influenced because of its neighbours, is unavoidably caused by the sub-wavelength narrow distances across IRS-NOMA reflecting elements. This results in meticulously coupled coefficients for reflection between reflecting elements' [164], [193]. The IRS-NOMA channel estimation along with passive beamforming architectures are exceedingly complicated in the traditional IRS-NOMA hardware paradigm, which implies independent control of reflection across distinct reflecting elements. Accurately acquiring the element wise distributed channels independently is an immense challenge when dealing with IRS-NOMA channel estimation involving mutual coupling. Within the finest of our understanding, such a problem is yet to be addressed in the body of currently available research. A viable and realistic approach includes reverting towards the element grouping technique [47] and [121], that unites neighbouring elements forming a subsurface; beneath these, the subsurface's might have moderate mutual coupling between them. This prevents the effect of mutual coupling alongside lowers training overhead since only the subsurface level channels have to be estimated. To really comprehend how to combine neighbouring elements appropriately for avoiding unfavourable mutual coupling yet attaining sufficient efficacy

in the IRS-NOMA channel estimation along with passive beamforming architecture, additional thorough research is recommended. The received signal-to-noise ratio of the impedance-reliant channel framework is comparable to that of the communication theoretic frameworks [37], but it's exceedingly challenging to handle because of the phase-dependent amplitude, the presence of self impedance, along with mutual coupling.

c: PHASE-DEPENDENT AMPLITUDE REFLECTION

Every IRS reflecting element's reflection amplitude seems essentially non-constant as well as non-linear with regard to its phase shift, as illustrated in [165] and [166], regardless of the fact that the majority of the IRS-NOMA works currently available have presumed independent control within the IRS-NOMA reflection phase shift along with its amplitude. At zero phase shift value, the IRS-NOMA's amplitude of reflection frequently reaches its most minimal value; whenever the phase shift goes to $-\pi$ or π , it grows systematically and asynchronously towards its highest value of one. Practical IRS-NOMA channel estimation along with passive beamforming architectures have been rendered extremely challenging with this sort of phase-dependent amplitude under control, as the traditional method of separately optimizing the IRS-NOMA phase shift along with amplitude is not practicable. Employing the BCD optimization strategy, the researchers in [160] proposed a tweaked IRS-NOMA training pattern for reflection to reduce the channel estimation error as well as overwhelm the challenges of IRS-NOMA channel estimation. This strategy proved to be more effective in practice as compared to the traditional training layout that assumed independent phase shift along with amplitude control. Several optimization techniques were successfully set out to construct the IRS-NOMA passive beamforming employing the amplitude phase-dependent controlling model in light of the CSI. Most notably, [165] employed the element wise BCD technique to continuously optimizing for every phase shift while holding the remainder constant and accounting for the impact on the reflection's amplitude.

B. FUTURE PERSPECTIVES

The subsequent subsection highlights key research domains for future perspectives.

1) COMMUNICATION ENHANCED VIA SENSING

An extensive investigation has been conducted into leveraging current communication channels for sensing purposes. Simultaneously, sensing ought to enhance communication, particularly in high-frequency bands like mmWave as well as terahertz (THz). Because of the substantial propagation degradation within these frequency groups, beamforming with narrow beams is frequently utilized as a remedy for path loss. Whenever either the recipients or broadcasters undergo movement, the linkages of communication, such as the path of rays, need to be continually tweaked in order to

maintain acceptable orientations and thereby ensure adequate throughput. Beam reorganization by means of training as well as refining may prove costly, particularly in a narrow beam such as a pencil beam layout with rapid movement. However, in the event the spot as well as the trajectories of recipients are readily estimated or variations in the immediate vicinity are predictable, the beam may be tweaked in real time, greatly decreasing the necessity for beam training or refining. As an illustration, in automotive networks, tracking and forecasting vehicle kinematic characteristics might help to decrease beam tracking overhead [5], [157].

Perhaps it's noteworthy to demonstrate that, alongside the growing interest in 6G THz dissemination, sensing has become an increasingly vital element to enable communications. New and promising strategies like intelligent reflecting surface (IRS) might be deployed to enhance the range of communication via smart beamforming, that is strongly reliant on current time surveillance of the ecosystem for environment-sensitive beamforming [167]. To efficiently exploit sensing data to enhance communication in forthcoming wireless technologies, more investigation for future perspectives in modeling, test-bed development, simulation, along with certification is needed [157].

2) MOBILITY IN ISAC SYSTEMS FOR IRS-CONFIGURABLE ENVIRONMENTS

Mobility is an essential component of ISAC systems that has yet to be thoroughly researched. ISAC systems are ideal for automotive applications that include self-driving automobiles [168] as well as unmanned aerial vehicles (UAV) due to their intrinsic hardware, power, expenses, along with dimension reductions [169]. Moreover, the functionality of sensing frequently entails monitoring traveling objects instead of just detecting them immediately. IRSs, unlike ISAC systems, are usually immobile and placed at predetermined spots. Yet, new advancements indicate that [170] IRS are capable of being implanted in automobiles that move, resulting in uncertain locations and perspectives, further complicating ISAC systems.

Catering for mobility in ISAC systems for IRS-configured environments presents numerous research options. For instance, the placement and installation of IRSs may influence the trajectories of cellular systems, advocating a joint strategy for design for trajectories along with beamforming in IRS-configured ISAC. Additionally, tracing cellular objects during certain time periods may be improved by the joint layout of IRS reflection sequences with ISAC signaling systems. Ultimately, mobility has an influence on the underlying paradigm for communication as well as sensing channels. Although no trajectories or objects that move are needed, they should be part of signal processing scheme architecture [28].

3) ISAC-AIDED PERFECT CHANNEL AS WELL AS TARGET MODEL

Previous research has concentrated upon either one or many sensing activities requiring numerous sensing transmissions

as well as recipients. Studies like these provide evidence that sensing applications are feasible; nevertheless, the installation of systems as well as the demands of application may frequently have an impact on effectiveness. To combine such sensing properties for increasingly sophisticated activities while assisting the growing IoT applications of the smart world, it's necessary to pursue an infinitely large as well as further complex system made up of numerous activities in order to grasp an elementary knowledge of the layout challenges along with anticipated initial effectiveness before actual deployment. For this endeavor, a perfect modeling of the channel along with target were needed [157].

Achieving perfect target modeling within ISAC is crucial. Inside the ecosystem of wireless sensing, the spacing across the signal transmitter as well as the target can frequently be lesser compared to conventional radar systems; hence, the target shouldn't be treated as a mere point target. Instead, it must be treated as a stretched target that has several spreading centres modeled by radar cross-section. Several studies have used electromagnetic methodologies to compute reflected rays or bounce off a target [171], [172]. However, such strategies are extremely computational for real-world ray creation in system-level modeling. An optimal channel model must strike a compromise among precision and complexities, taking into consideration the varying polarization orientations of broadcaster and reception antennas. Additionally, in order to attain beneficial sensing, the time-shifting channel features, particularly the target, must be perfectly modeled.

4) ISAC-ENHANCED VIA ARTIFICIAL INTELLIGENCE (AI)

AI is projected as being fundamental and entirely embedded in 6G systems. Algorithms for AI that are sophisticated and powered by data open up novel possibilities for both wireless connectivity along with ISAC technology. Inside rich in data and complicated ISAC situations, particularly those that have weak interior as well as exterior channel circumstances, there are numerous multifaceted, inverse, yet chaotic/noisy findings, along with the physical parameters of the system's nonlinear signal qualities that may be undefined or challenging to estimate [173]. Conventional mathematical paradigms along with signal processing approaches solely lack the ability to address the difficult joint communication as well as sensing issues in these complicated ISAC settings. AI techniques may be used to simulate system behaviour, such as exacerbated communication as well as sensing channels, the immediate surroundings, as well as numerous system uncertainties. These models of AI enable the creation of higher-performing and resilient ISAC systems via integrating the positive aspects of data as well as model driven techniques. Additionally, ISAC systems may also supply a large amount of data to be used for AI model training and maturation because of their excellent sensing and communication capabilities. Thus, investigating the interaction of AI, sensing, as well as communication in ISAC-Enhanced via AI systems is of great interest [61].

5) RADIO-FREQUENCY (RF) SENSING WITH DATA ANALYSIS AND MACHINE LEARNING (ML)

ML, notably deep learning, have demonstrated an outstanding capacity to convert data acquired across diverse systems into more meaningful information, facilitating smart choice-making along with automated operation. ML proved amazing growth in numerous fields, namely empowering the cleverness of IoT devices, thanks to high-speed computation (edge or cloud computation) and sophisticated communication and network techniques [174]. To employ ML and data analysis within radar sensing, it's necessary to grasp the application's needs for performance, that is., precision as well as delay, and the characteristics of the accessible sensing data. Additionally, an organized structure is needed for facilitating ML at numerous levels as well as elements, allowing distributive along with transferable learning, and offering an empirical basis for ML, including resilience as well as explainability. Incorporating ML within radar sensing opens new future perspective multidisciplinary research opportunities, notably radar sensing with ML, sensing installation, along with it's procedures. Very low-delay radar analysis of data was enabled by ML, as well as ultra-low-delay and very dependable connectivity [157].

6) ISAC: SECURITY AND PRIVACY

An ISAC system comprises multiple elements and layers. Every element and their interconnections might be vulnerable to assault. Sensing and infrastructure for communication might become vulnerable to a variety of attacks, compromising the system's accessibility, reliability, and security. As an outcome, it's necessary to thoroughly investigate the system's different vulnerabilities and implement strategies to comprehend the implications of prospective hazards, along with creating preventative measures to protect ISAC systems. As an illustration, the most prevalent hazard within a sensing system is inept or compromised devices. The authors of [175] conducted an in-depth analysis on locating and acknowledging IoT gadgets. The authors reviewed current ML techniques for acknowledging gadgets based on patterns of wireless signals and traces of system traffic.

The ISAC system is also vulnerable to eavesdropping and jamming because of the shared waveform of sensing and communication. As an outcome, suitable preventative measures ought to be addressed in the physical layer layout for preventing data obtained from escaping to obnoxious sensing objects or passive radar recipients via the object's echoes. Safe communication mechanisms, especially low-cost authentication and encryption, ought to be explored in order to hinder messages being deciphered by eavesdroppers [176]. Furthermore, the efficiency consequences of security and privacy-preventative strategies that affect the ISAC system deserve further examination.

7) ISAC FOR EMERGING SPECTRUM/FREQUENCY BANDS

ISAC within the sub-THz and THz frequencies may be created from scrape without relying on current standardization.

As an outcome, several multifaceted ISAC architectures may be created, each with its own set of capabilities and distinct sensing as well as communication effectiveness trade offs. Researchers think that an information conceptual examination of the ISAC beneath novel channel attributes uncovers an inherent trade off within sensing and communication, leading to a fresh layout of system specs. To develop novel waveforms for certain channel types and applications, consider the layout of system requirements, including signal processing at broadcasters and recipients. Furthermore, frameworks such as extremely massive antennas for pen-like beamforming along with IRSs that sculpt channel propagation conditions beneficial to ISAC ought to be investigated in order to deal with substantial path losses in sub-THz and THz frequencies. In the entire system architecture, ML, along with deep learning, will serve critical roles in sensing and detection of data while managing the pattern of beam and reflection and absorption patterns of IRS [130].

8) COLLABORATIVE AND DISTRIBUTED ISAC

Previously noted, in order to support ubiquitous IoT gadgets that are able to sense, compute, and communicate, forthcoming IoT systems may deploy several IRS along with UAVs in addition to BS [177]. In addition to producing diverse sensory input, these ISAC constituents also provide correlated data. Analyzing and communicating the sensory input dispersed throughout the network to extract desired characteristics along with data for a variety of applications, such as regression, is another essential field for investigation [178]. The majority of RF sensing devices in operation presently are very reliant on the environment and sensor placement, and they are designed to target a single application. Collaborative sensing is an integral empowering technique that helps systems for sensing efficiently respond to real-world scenarios as well as capitalize on the universal accessibility of wireless gadgets. Several gadgets can work together within a team in collaborative sensing for gathering more data regarding the environment around them [157]. Three potential strategies for installing collaborative sensing are portrayed in Fig. 20. In the primary installation, as presented in Fig. 20(a), numerous STATIONs may transmit their sensing data straight to the initiator, subsequent to analyzing the CSI metrics. The access point initiator can then aggregate all of the sensing information to reach a conclusion. A one-bit response received from every STATION indicating its proximity position ought to be taken into consideration in certain usage scenarios, like presence detection. In the secondary installation, as shown in Fig. 20(b), as the initiator functions as a processor and processes the CSI data directly, numerous STATIONs may provide feedback on respective CSI measures in an ordered manner. As the raw measures of several channels might become available, the access point could then gather more data regarding its surrounding environment. In the tertiary installation, as illustrated in Fig. 20(c), the initiator serves as both a processor as well as

a receiver. The initiator first sends a trigger packet to every STATION. If a responder is willing to take part in sensing, it responds to the trigger message by sending a CTS-to-self packet. Every STATION that consented to be involved then receives a fresh transmission of the trigger packet from the initiator. In response, every STATION sounds the channel by sending a null data packet (NDP) one at a time [157].

VIII. LIMITATIONS OF IRS-NOMA FOR ISAC

In addition to the research challenges aforementioned above for IRS-NOMA in ISAC, there are certain fundamental limitations that are unique to IRS for ISAC. The IRS limitations for ISAC upcoming wireless communication technologies are multifaceted and can be summarized as follows:

- **Fixed electromagnetic characteristics:** Electromagnetic characteristics are fixed shortly thereafter, fabricating an IRS (metamaterial) for ISAC with a distinct physical structure. The lack of flexibility hinders its ability to tweak and makes it unsuitable towards dynamic shifts. The metamaterial is restricted to a specific purpose or range of frequency, allowing for the development and production of a new metamaterial capable of handling various tasks or frequency ranges.
- **Inadequate digital processing capabilities:** IRS components were created with principles of analog beamforming notions in mind and don't have integrated sensing guidance for features like digital processing. IRS works primarily in the analog world, in comparison to particular relay platforms, which may incorporate advanced versions of digital signal processing algorithms to improve effectiveness. The aforementioned limitation might hamper the pliability of the system as well as engineering capacity for optimization, hampering its capability to effectively supervise diversified integrated sensing and communication scenarios.
- **Restricts pliability or inpliability of IRS for ISAC:** The inpliability of IRS for ISAC derives through the requirement for redesigning and rebuilding whenever a newer function or range of frequencies are needed. IRS is inpliable because the dimensional properties of the propagation units that constitute the metamaterial must be adjusted based on the requirements for application. A fresh calibration requires a difficult computational synthesis methodology. IRS's capability to switch to real-world or switching wireless ecosystems is limited by the need to rethink and recalculate.
- **Computational needs:** The synthetic methodology for reevaluating parameters related to structure raises the complexity of computation of the design process of the architecture. This computation need might be a substantial constraint/limitation, with particular regard to real-world updates or complex wireless communication scenarios. These constraints/limitations may result in delays in deployment or increased design expenses.

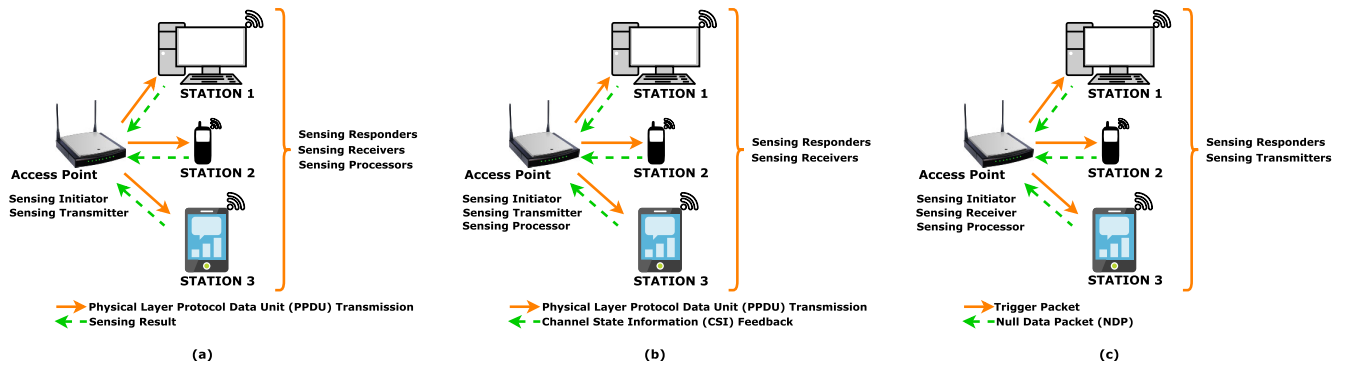

FIGURE 20. Three potential installations for collaborative WiFi or Wireless Local Area Network (WLAN) sensing. (a) Primary installation, (b) Secondary installation, and (c) Tertiary installation.

- **Complex network topologies of ISAC:** One of the basic limitations is the network topologies of ISAC, which are developed by combining sensing as well as communication network topologies. Such as assume mono-static interference networks, wherein numerous transmitters and receivers communication units conflict with one another, where every transmission transmitter serves as a transmitter for radar for detecting objects that are shifting. These limitations might result in complex network topologies of ISAC, increasing design costs.

IX. LESSONS LEARNED

The survey paper on IRS-NOMA for integrated sensing and communication sheds valuable insights into the potential benefits of IRS-NOMA technologies, highlighting their role in boosting ISAC systems and forthcoming wireless communication networks. Numerous critical lessons and favourable outcomes can be gleaned from the paper:

- **Holistic overview of NOMA:** The present survey paper covers a holistic overview of NOMA and linked signal processing techniques, covering NOMA in downlink and uplink networks along with sum rate analysis. This knowledge is critical for grasping the practical features of NOMA to improve the spectral efficiency of wireless communication networks.
- **Comprehensive overview of IRS:** The research article delivers a comprehensive overview of IRS, including IRS hardware along with equivalent RLC circuits and tuning processes of IRS. The tuning of IRS elements is portrayed as a critical feature in IRS-assisted networks, as it significantly impacts the overall system performance. This insight serves as pivotal for grasping the physical architecture needed in installing IRS in real-world wireless networks.
- **IRS mathematical modeling:** The paper delves into the visual representation and mathematical signal processing model for different scenarios, including both single and multiple IRS configurations. This knowledge proves pivotal for researchers in mathematical modeling of IRS-assisted systems.
- **Pliable setup for real-time efficiency:** The IRS's ability for evolving and tweaking its setup for real-time efficiency is vital for enhancing wireless communication. Such pliability has the potential to improve sensing and communication while reducing signal limitation or interference in future networks.
- **Detailed overview of ISAC:** The research paper covers a detailed overview of ISAC, covering its architecture, frequency bands of operation, application areas, and current technological standards. It also highlights the relative merits and demerits of various configurations.
- **Performance metrics of ISAC:** The survey paper emphasizes a thorough overview of the performance matrices of ISAC to evaluate the performance of the radar and communication system for an ISAC system. These performance metrics will be invaluable in characterizing the sensing, communication, and ISAC systems.
- **IRS-NOMA assisted ISAC:** The article summarizes the advancement of the IRS-NOMA assisted ISAC-related research, with an in-depth explanation of objectives, methodologies, IRS deployment strategies, and related achievements. Additionally, with tabulation, it summarizes and compares the works that are on the IRS-NOMA assisted ISAC system, exploration of system metrics utilization, a comparison of algorithms associated with IRS-NOMA-aided ISAC, and different IRS-NOMA approaches within ISAC systems. This research proves pivotal for leveraging IRS-NOMA assisted ISAC systems to achieve higher spectral efficiency, improved sensing accuracy, and more reliable communication links in the practical scenario of wireless communication systems.
- **Mathematical modeling for IRS-NOMA assisted ISAC:** The paper delves into the mathematical model for an IRS-NOMA assisted ISAC system, covering a detailed overview of the communication model, radar model, and optimization. This knowledge proves pivotal for researchers in mathematical modeling and for grasping the physical architecture needed in installing IRS-NOMA assisted ISAC in real-world wireless networks.

- *Interplay of IRS-aided ISAC NOMA with emerging technologies for 6G realization*: The manuscript emphasizes the potential application scenario for the IRS-aided ISAC NOMA, which can communicate with and augment other cutting-edge technologies on the pathway to 6G connectivity. This highlights the broader context of how these integrated technologies might fit into the vision of next-generation wireless communications.
- *Challenges and future perspectives*: The manuscript acknowledges the benefits of an IRS-NOMA assisted ISAC system while highlighting significant practical challenges and implementation issues associated with IRS-NOMA in ISAC, notably algorithmic complexities, i.e., signal processing complexities, hardware limitations and impairment, and security and privacy concerns associated with IRS-NOMA in ISAC. Acknowledging and overcoming these challenges will be essential to identifying future perspectives and accelerating the real-world implementation of ISAC-NOMA-IRS in wireless networks.
- *Limitations of IRS-NOMA for ISAC*: The manuscript additionally stresses the key limitations linked with the integration of IRS, NOMA, and ISAC. Addressing and resolving these limitations will be critical for discovering future opportunities and speeding up the application of ISAC-NOMA-IRS networks.

In a nutshell, the survey paper conveys the current state-of-the-art in ISAC using NOMA techniques, encompassing topics notably NOMA, IRS along with its mathematical modeling, ISAC along with performance metrics, IRS-NOMA assisted ISAC along with its mathematical modeling, and interplay off IRS-aided ISAC NOMA and strengthen other emerging technologies on the journey towards 6G connectivity. It not only acknowledges the benefits that an IRS-NOMA assisted ISAC system promises but also addresses the challenges and limitations, paving the way for future perspectives in the field.

X. CONCLUSION

In this survey, we have explored the current state-of-the-art in ISAC using NOMA techniques. We examined the key advancements, challenges, and future directions in this emerging field, highlighting how IRS-NOMA can significantly enhance the efficiency and performance of integrated systems. By leveraging IRS, these systems can optimize signal reflection to improve data transmission and sensing accuracy, while NOMA allows multiple users to access resources simultaneously, enhancing network efficiency. This study reveals that IRS-NOMA holds great promise for advancing wireless network capabilities by improving spectrum utilization, enhancing data rates, and enabling efficient sensing capabilities. The integration of IRS with NOMA techniques presents a synergistic approach that leverages the strengths of both technologies to address the growing demands for high-speed, reliable, and versatile wireless com-

munication systems. However, several challenges remain, including the need for robust algorithms, effective resource allocation strategies, and improved hardware designs to fully realize the potential of IRS-NOMA. Future research should focus on addressing these challenges and exploring innovative solutions to further optimize system performance and scalability. As the field continues to evolve, IRS-NOMA is expected to play a pivotal role in shaping the future of integrated sensing and communication systems. By advancing both theoretical and practical aspects, researchers and engineers can contribute to the development of more efficient, intelligent, and adaptive networks that meet the demands of next-generation applications.

REFERENCES

- [1] A. Pourkabirian, M. S. Kordafshari, A. Jindal, and M. H. Anisi, "A vision of 6G URLLC: Physical-layer technologies and enablers," *IEEE Commun. Standards Mag.*, vol. 8, no. 2, pp. 20–27, Jun. 2024.
- [2] L. Bing, Y. Gu, L. Hu, T. Aulin, Y. Yin, and J. Wang, "QoS provision for industrial IoT networking: Multiantenna NOMA based on partial CSIT," *IEEE Trans. Ind. Informat.*, vol. 20, no. 6, pp. 8239–8250, Jun. 2024.
- [3] O. Elgarhy, L. Reggiani, M. M. Alam, A. Zoha, R. Ahmad, and A. Kuusik, "Energy efficiency and latency optimization for IoT URLLC and mMTC use cases," *IEEE Access*, vol. 12, pp. 23132–23148, 2024.
- [4] J. A. Zhang, Md. L. Rahman, K. Wu, X. Huang, Y. J. Guo, S. Chen, and J. Yuan, "Enabling joint communication and radar sensing in mobile networks—A survey," *IEEE Commun. Surveys Tuts.*, vol. 24, no. 1, pp. 306–345, 1st Quart., 2022.
- [5] F. Liu, C. Masouros, A. P. Petropulu, H. Griffiths, and L. Hanzo, "Joint radar and communication design: Applications, state-of-the-art, and the road ahead," *IEEE Trans. Commun.*, vol. 68, no. 6, pp. 3834–3862, Jun. 2020.
- [6] A. Nasser, A. Celik, and A. M. Eltawil, "Joint user-target pairing, power control, and beamforming for NOMA-aided ISAC networks," *IEEE Trans. Cognit. Commun. Netw.*, early access, Jul. 15, 2024, doi: 10.1109/TCCN.2024.3427781.
- [7] Z. Ding, Y. Liu, J. Choi, Q. Sun, M. ElKashlan, I. Chih-Lin, and H. V. Poor, "Application of non-orthogonal multiple access in LTE and 5G networks," *IEEE Commun. Mag.*, vol. 55, no. 2, pp. 185–191, Feb. 2017.
- [8] L. Dai, B. Wang, Y. Yuan, S. Han, I. Chih-lin, and Z. Wang, "Non-orthogonal multiple access for 5G: Solutions, challenges, opportunities, and future research trends," *IEEE Commun. Mag.*, vol. 53, no. 9, pp. 74–81, Sep. 2015.
- [9] Y. Liu, Z. Qin, M. ElKashlan, Z. Ding, A. Nallanathan, and L. Hanzo, "Nonorthogonal multiple access for 5G and beyond," *Proc. IEEE*, vol. 105, no. 12, pp. 2347–2381, Dec. 2017.
- [10] H. Q. Tran, P. Q. Truong, C. V. Phan, and Q.-T. Vien, "On the energy efficiency of NOMA for wireless backhaul in multi-tier heterogeneous CRAN," in *Proc. Int. Conf. Recent Adv. Signal Process., Telecommun. Comput. (SigTelCom)*, Jan. 2017, pp. 229–234.
- [11] H. Q. Tran, C. V. Phan, and Q.-T. Vien, "On the performance of regenerative relaying for SWIPT in NOMA systems," in *Proc. 26th Int. Conf. Telecommun. (ICT)*, Apr. 2019, pp. 1–5.
- [12] R. O. Ogundokun, J. B. Awotunde, A. L. Imoize, C.-T. Li, A. T. Abdulahi, A. B. Adelodun, S. N. Sur, and C.-C. Lee, "Non-orthogonal multiple access enabled mobile edge computing in 6G communications: A systematic literature review," *Sustainability*, vol. 15, no. 9, p. 7315, Apr. 2023.
- [13] H. Q. Tran and S. N. Sur, "Effective capacity analysis of full-duplex-cooperative non-orthogonal multiple access systems," *TELKOMNIKA (Telecommun. Comput. Electron. Control)*, vol. 22, no. 5, p. 1083, May 2024.
- [14] Z. Ding, P. Fan, and H. V. Poor, "Impact of user pairing on 5G nonorthogonal multiple-access downlink transmissions," *IEEE Trans. Veh. Technol.*, vol. 65, no. 8, pp. 6010–6023, Aug. 2016.
- [15] Q. Wu and R. Zhang, "Towards smart and reconfigurable environment: Intelligent reflecting surface aided wireless network," *IEEE Commun. Mag.*, vol. 58, no. 1, pp. 106–112, Jan. 2020.

- [16] S. Rajak, I. Muniraj, P. Selvaprabhu, V. B. Kumaravelu, M. A. L. Sarker, S. Chinnadurai, and D. S. Han, "A novel energy efficient IRS-relay network for ITS with Nakagami- m fading channels," *ICT Exp.*, vol. 10, no. 3, pp. 507–512, Jun. 2024.
- [17] C. Huang, A. Zappone, G. C. Alexandropoulos, M. Debbah, and C. Yuen, "Reconfigurable intelligent surfaces for energy efficiency in wireless communication," *IEEE Trans. Wireless Commun.*, vol. 18, no. 8, pp. 4157–4170, Aug. 2019.
- [18] M. Di Renzo, A. Zappone, M. Debbah, M.-S. Alouini, C. Yuen, J. de Rosny, and S. Tretyakov, "Smart radio environments empowered by reconfigurable intelligent surfaces: How it works, state of research, and the road ahead," *IEEE J. Sel. Areas Commun.*, vol. 38, no. 11, pp. 2450–2525, Nov. 2020.
- [19] X. Liu, T. Huang, N. Shlezinger, Y. Liu, J. Zhou, and Y. C. Eldar, "Joint transmit beamforming for multiuser MIMO communications and MIMO radar," *IEEE Trans. Signal Process.*, vol. 68, pp. 3929–3944, 2020.
- [20] W. Tang, M. Z. Chen, X. Chen, J. Y. Dai, Y. Han, M. Di Renzo, Y. Zeng, S. Jin, Q. Cheng, and T. J. Cui, "Wireless communications with reconfigurable intelligent surface: Path loss modeling and experimental measurement," *IEEE Trans. Wireless Commun.*, vol. 20, no. 1, pp. 421–439, Jan. 2021.
- [21] R. Q. Hu and Y. Qian, "An energy efficient and spectrum efficient wireless heterogeneous network framework for 5G systems," *IEEE Commun. Mag.*, vol. 52, no. 5, pp. 94–101, May 2014.
- [22] W. Lai, W. Ni, H. Wang, and R. P. Liu, "Analysis of average packet loss rate in multi-hop broadcast for VANETs," *IEEE Commun. Lett.*, vol. 22, no. 1, pp. 157–160, Jan. 2018.
- [23] D. K. Pin Tan, J. He, Y. Li, A. Bayesteh, Y. Chen, P. Zhu, and W. Tong, "Integrated sensing and communication in 6G: Motivations, use cases, requirements, challenges and future directions," in *Proc. 1st IEEE Int. Online Symp. Joint Commun. Sens. (JC&S)*, Feb. 2021, pp. 1–6.
- [24] X. Zhang, Z. He, Y. Sun, S. Yuan, and M. Peng, "Joint sensing, communication, and computation resource allocation for cooperative perception in fog-based vehicular networks," in *Proc. 13th Int. Conf. Wireless Commun. Signal Process. (WCSP)*, Oct. 2021, pp. 1–6.
- [25] M. Rihan, A. Zappone, S. Buzzi, G. Fodor, and M. Debbah, "Passive versus active reconfigurable intelligent surfaces for integrated sensing and communication: Challenges and opportunities," *IEEE Netw.*, vol. 38, no. 3, pp. 218–226, May 2024.
- [26] X. Mu, Z. Wang, and Y. Liu, "NOMA for integrating sensing and communications towards 6G: A multiple access perspective," *IEEE Wireless Commun.*, vol. 31, no. 3, pp. 316–323, Jun. 2024.
- [27] R. Liu, M. Li, H. Luo, Q. Liu, and A. L. Swindlehurst, "Integrated sensing and communication with reconfigurable intelligent surfaces: Opportunities, applications, and future directions," *IEEE Wireless Commun.*, vol. 30, no. 1, pp. 50–57, Feb. 2023.
- [28] S. P. Chepuri, N. Shlezinger, F. Liu, G. C. Alexandropoulos, S. Buzzi, and Y. C. Eldar, "Integrated sensing and communications with reconfigurable intelligent surfaces: From signal modeling to processing," *IEEE Signal Process. Mag.*, vol. 40, no. 6, pp. 41–62, Sep. 2023.
- [29] Z. Zhang, Z. Wang, X. Mu, J. Chen, and Y. Liu, "STARS for integrated sensing and communications: Challenges, solutions, and future directions," 2023, [arXiv:2309.17321](https://arxiv.org/abs/2309.17321).
- [30] M. Asif Haider and Y. D. Zhang, "RIS-aided integrated sensing and communication: A mini-review," *Frontiers Signal Process.*, vol. 3, May 2023, Art. no. 1197240.
- [31] T. M. Cover, "Broadcast channels," *IEEE Trans. Inf. Theory*, vol. IT-18, no. 1, pp. 2–14, Jan. 1972.
- [32] S. Vanka, S. Srinivasa, Z. Gong, P. Vizi, K. Stamatiou, and M. Haenggi, "Superposition coding strategies: Design and experimental evaluation," *IEEE Trans. Wireless Commun.*, vol. 11, no. 7, pp. 2628–2639, Jul. 2012.
- [33] L. E. Li, R. Alimi, R. Ramjee, J. Shi, Y. Sun, H. Viswanathan, and Y. R. Yang, "Superposition coding for wireless mesh networks," in *Proc. 13th Annu. ACM Int. Conf. Mobile Comput. Netw. (MobiCom)*, 2007, pp. 330–333.
- [34] R. M. Buehrer, "Equal BER performance in linear successive interference cancellation for CDMA systems," *IEEE Trans. Commun.*, vol. 49, no. 7, pp. 1250–1258, Jul. 2001.
- [35] R. C. Kizilirmak, "Non-orthogonal multiple access (NOMA) for 5G networks," in *Towards 5G Wireless Networks: A Physical Layer Perspective*. London, U.K.: InTech, Dec. 2016.
- [36] M. Aldababsa, M. Toka, S. Gökçeli, G. K. Kurt, and O. Kucur, "A tutorial on non-orthogonal multiple access for 5G and beyond," *Wireless Commun. Mobile Comput.*, vol. 2018, pp. 1–24, Jun. 2018.
- [37] Q. Wu, S. Zhang, B. Zheng, C. You, and R. Zhang, "Intelligent reflecting surface-aided wireless communications: A tutorial," *IEEE Trans. Commun.*, vol. 69, no. 5, pp. 3313–3351, May 2021.
- [38] C. Pan, G. Zhou, K. Zhi, S. Hong, T. Wu, Y. Pan, H. Ren, M. D. Renzo, A. Lee Swindlehurst, R. Zhang, and A. Y. Zhang, "An overview of signal processing techniques for RIS/IRS-aided wireless systems," *IEEE J. Sel. Topics Signal Process.*, vol. 16, no. 5, pp. 883–917, Aug. 2022.
- [39] S. N. Sur and R. Bera, "Intelligent reflecting surface assisted MIMO communication system: A review," *Phys. Commun.*, vol. 47, Aug. 2021, Art. no. 101386.
- [40] S. N. Sur, A. K. Singh, D. Kandar, A. Silva, and N. D. Nguyen, "Intelligent reflecting surface assisted localization: Opportunities and challenges," *Electronics*, vol. 11, no. 9, p. 1411, Apr. 2022.
- [41] H. Zhang, S. Ma, Z. Shi, X. Zhao, and G. Yang, "Sum-rate maximization of RIS-aided multi-user MIMO systems with statistical CSI," *IEEE Trans. Wireless Commun.*, vol. 22, no. 7, pp. 4788–4801, Jul. 2023.
- [42] S. N. Sur, D. Kandar, A. L. Imoize, and R. Bera, "An overview of intelligent reflecting surface assisted UAV communication systems," in *Unmanned Aerial Vehicle Cellular Communications*. Cham, Switzerland: Springer, Jun. 2022, pp. 67–94.
- [43] S. Gong, X. Lu, D. T. Hoang, D. Niyato, L. Shu, D. I. Kim, and Y.-C. Liang, "Toward smart wireless communications via intelligent reflecting surfaces: A contemporary survey," *IEEE Commun. Surveys Tuts.*, vol. 22, no. 4, pp. 2283–2314, 4th Quart., 2020.
- [44] H. Yang, X. Cao, F. Yang, J. Gao, S. Xu, M. Li, X. Chen, Y. Zhao, Y. Zheng, and S. Li, "A programmable metasurface with dynamic polarization, scattering and focusing control," *Sci. Rep.*, vol. 6, no. 1, pp. 1–11, Oct. 2016.
- [45] X. Wan, M. Q. Qi, T. Y. Chen, and T. J. Cui, "Field-programmable beam reconfiguring based on digitally-controlled coding metasurface," *Sci. Rep.*, vol. 6, no. 1, p. 20663, Feb. 2016.
- [46] S. V. Hum and J. Perruisseau-Carrier, "Reconfigurable reflectarrays and array lenses for dynamic antenna beam control: A review," *IEEE Trans. Antennas Propag.*, vol. 62, no. 1, pp. 183–198, Jan. 2014.
- [47] Y. Yang, B. Zheng, S. Zhang, and R. Zhang, "Intelligent reflecting surface meets OFDM: Protocol design and rate maximization," *IEEE Trans. Commun.*, vol. 68, no. 7, pp. 4522–4535, Jul. 2020.
- [48] J. P. Turpin, J. A. Bossard, K. L. Morgan, D. H. Werner, and P. L. Werner, "Reconfigurable and tunable metamaterials: A review of the theory and applications," *Int. J. Antennas Propag.*, vol. 2014, pp. 1–18, May 2014.
- [49] A. R. Katko, A. M. Hawkes, J. P. Barrett, and S. A. Cummer, "RF limiter metamaterial using p-i-n diodes," *IEEE Antennas Wireless Propag. Lett.*, vol. 10, pp. 1571–1574, 2011.
- [50] S. Venkatesh, X. Lu, H. Saiedi, and K. Sengupta, "A high-speed programmable and scalable terahertz holographic metasurface based on tiled CMOS chips," *Nature Electron.*, vol. 3, no. 12, pp. 785–793, Dec. 2020.
- [51] S. Rout and S. R. Sonkusale, "A low-voltage high-speed terahertz spatial light modulator using active metamaterial," *APL Photon.*, vol. 1, no. 8, Aug. 2016, Art. no. 086102.
- [52] J. Oberhammer, "THz MEMS—Micromachining enabling new solutions at millimeter and submillimeter frequencies," in *Proc. Global Symp. Millim. Waves (GSMM) ESA Workshop Millimetre-Wave Technol. Appl.*, Jun. 2016, pp. 1–4.
- [53] H. Ruan, T. G. Saunders, H. Giddens, H. Zhang, A. A. Ihalage, J. F. Kolb, M. Blunt, S. Haq, H. Yan, and Y. Hao, "Microwave characterization of two Ba_{0.6}Sr_{0.4}TiO₃ dielectric thin films with out-of-plane and in-plane electrode structures," *J. Adv. Ceram.*, vol. 12, no. 8, pp. 1521–1532, Aug. 2023.
- [54] P. Pitchappa, A. Kumar, S. Prakash, H. Jani, T. Venkatesan, and R. Singh, "Chalcogenide phase change material for active terahertz photonics," *Adv. Mater.*, vol. 31, no. 12, Jan. 2019, Art. no. 1808157.
- [55] R. Matos and N. Pala, "A review of phase-change materials and their potential for reconfigurable intelligent surfaces," *Micromachines*, vol. 14, no. 6, p. 1259, Jun. 2023.
- [56] S. Savo, D. Shrekenhamer, and W. J. Padilla, "Liquid crystal metamaterial absorber spatial light modulator for THz applications," *Adv. Opt. Mater.*, vol. 2, no. 3, pp. 275–279, Jan. 2014.

- [57] M. Tamagnone, S. Capdevila, A. Lombardo, J. Wu, A. Centeno, A. Zurutuza, A. M. Ionescu, A. C. Ferrari, and J. R. Mosig, "Graphene reflectarray metasurface for terahertz beam steering and phase modulation," 2018, *arXiv:1806.02202*.
- [58] Y. Malevich, M. S. Ergoktas, G. Bakan, P. Steiner, and C. Kocabas, "Video-speed graphene modulator arrays for terahertz imaging applications," *ACS Photon.*, vol. 7, no. 9, pp. 2374–2380, Aug. 2020.
- [59] M. R. M. Hashemi, S.-H. Yang, T. Wang, N. Sepúlveda, and M. Jarrahi, "Electronically-controlled beam-steering through vanadium dioxide metasurfaces," *Sci. Rep.*, vol. 6, no. 1, p. 35439, Oct. 2016.
- [60] W. Saad, M. Bennis, and M. Chen, "A vision of 6G wireless systems: Applications, trends, technologies, and open research problems," *IEEE Netw.*, vol. 34, no. 3, pp. 134–142, May 2020.
- [61] F. Liu, Y. Cui, C. Masouros, J. Xu, T. X. Han, Y. C. Eldar, and S. Buzzi, "Integrated sensing and communications: Toward dual-functional wireless networks for 6G and beyond," *IEEE J. Sel. Areas Commun.*, vol. 40, no. 6, pp. 1728–1767, Jun. 2022.
- [62] H. Griffiths, L. Cohen, S. Watts, E. Mokole, C. Baker, M. Wicks, and S. Blunt, "Radar spectrum engineering and management: Technical and regulatory issues," *Proc. IEEE*, vol. 103, no. 1, pp. 85–102, Jan. 2015.
- [63] Y. Cui, F. Liu, X. Jing, and J. Mu, "Integrating sensing and communications for ubiquitous IoT: Applications, trends, and challenges," *IEEE Netw.*, vol. 35, no. 5, pp. 158–167, Sep. 2021.
- [64] B. Paul, A. R. Chiriyath, and D. W. Bliss, "Survey of RF communications and sensing convergence research," *IEEE Access*, vol. 5, pp. 252–270, 2017.
- [65] L. Zheng, M. Lops, Y. C. Eldar, and X. Wang, "Radar and communication coexistence: An overview: A review of recent methods," *IEEE Signal Process. Mag.*, vol. 36, no. 5, pp. 85–99, Sep. 2019.
- [66] A. Martone and M. Amin, "A view on radar and communication systems coexistence and dual functionality in the era of spectrum sensing," *Digit. Signal Process.*, vol. 119, Dec. 2021, Art. no. 103135.
- [67] A. Hassani, M. G. Amin, E. Aboutanos, and B. Himed, "Dual-function radar communication systems: A solution to the spectrum congestion problem," *IEEE Signal Process. Mag.*, vol. 36, no. 5, pp. 115–126, Sep. 2019.
- [68] T. Huang, X. Xu, Y. Liu, N. Shlezinger, and Y. C. Eldar, "A dual-function radar communication system using index modulation," in *Proc. IEEE 20th Int. Workshop Signal Process. Adv. Wireless Commun. (SPAWC)*, Jul. 2019, pp. 1–5.
- [69] H. Wang, J. Johnson, C. Baker, L. Ye, and C. Zhang, "On spectrum sharing between communications and air traffic control radar systems," in *Proc. IEEE Radar Conf. (RadarCon)*, May 2015, pp. 1545–1550.
- [70] H. Wang, J. T. Johnson, and C. J. Baker, "Spectrum sharing between communications and ATC radar systems," *IET Radar, Sonar Navigat.*, vol. 11, no. 6, pp. 994–1001, Jun. 2017.
- [71] J. H. Reed, A. W. Clegg, A. V. Padaki, T. Yang, R. Nealy, C. Dietrich, C. R. Anderson, and D. M. Mearns, "On the co-existence of TD-LTE and radar over 3.5 GHz band: An experimental study," *IEEE Wireless Commun. Lett.*, vol. 5, no. 4, pp. 368–371, Aug. 2016.
- [72] S. Kim, J. Choi, and C. Dietrich, "PSUN: An OFDM-pulsed radar coexistence technique with application to 3.5 GHz LTE," *Mobile Inf. Syst.*, vol. 2016, pp. 1–13, Apr. 2016.
- [73] F. Hesar and S. Roy, "Spectrum sharing between a surveillance radar and secondary Wi-Fi networks," *IEEE Trans. Aerosp. Electron. Syst.*, vol. 52, no. 3, pp. 1434–1448, Jun. 2016.
- [74] S. Bhattarai, P. R. Vaka, and J.-M. Park, "Co-existence of NB-IoT and radar in shared spectrum: An experimental study," in *Proc. IEEE Global Commun. Conf. (GLOBECOM)*, Dec. 2017, pp. 1–6.
- [75] P. Kumari, J. Choi, N. González-Prelcic, and R. W. Heath, "IEEE 802.11ad-based radar: An approach to joint vehicular communication-radar system," *IEEE Trans. Veh. Technol.*, vol. 67, no. 4, pp. 3012–3027, Apr. 2018.
- [76] W. Roh, J.-Y. Seol, J. Park, B. Lee, J. Lee, Y. Kim, J. Cho, K. Cheun, and F. Aryanfar, "Millimeter-wave beamforming as an enabling technology for 5G cellular communications: Theoretical feasibility and prototype results," *IEEE Commun. Mag.*, vol. 52, no. 2, pp. 106–113, Feb. 2014.
- [77] J. Choi, V. Va, N. Gonzalez-Prelcic, R. Daniels, C. R. Bhat, and R. W. Heath, "Millimeter-wave vehicular communication to support massive automotive sensing," *IEEE Commun. Mag.*, vol. 54, no. 12, pp. 160–167, Dec. 2016.
- [78] P. Kumari, N. Gonzalez-Prelcic, and R. W. Heath, "Investigating the IEEE 802.11ad standard for millimeter wave automotive radar," in *Proc. IEEE 82nd Veh. Technol. Conf. (VTC-Fall)*, Sep. 2015, pp. 1–5.
- [79] W. D. C. Henry O. Everitt and J. T. Richard, "Terahertz (THz) radar: A solution for degraded visibility environments (DVE)," Army Res. Develop. Eng. Command, Redstone Arsenal, AL, USA, Tech. Rep. TR-RDMR-WD-16-49, 2016.
- [80] Z. Zhou, Z. Cao, and Y. Pi, "Dynamic gesture recognition with a terahertz radar based on range profile sequences and Doppler signatures," *Sensors*, vol. 18, no. 1, p. 10, Dec. 2017.
- [81] H.-J. Song and T. Nagatsuma, "Present and future of terahertz communications," *IEEE Trans. THz Sci. Technol.*, vol. 1, no. 1, pp. 256–263, Sep. 2011.
- [82] C. Castro, R. Elschner, T. Merkle, C. Schubert, and R. Freund, "Long-range high-speed THz-wireless transmission in the 300 GHz band," in *Proc. 3rd Int. Workshop Mobile THz Syst. (IWMTS)*, Jul. 2020, pp. 1–4.
- [83] K. Kim, J. Kim, and J. Joung, "A survey on system configurations of integrated sensing and communication (ISAC) systems," in *Proc. 13th Int. Conf. Inf. Commun. Technol. Converg. (ICTC)*, Oct. 2022, pp. 1176–1178.
- [84] J. Mu, Y. Gong, F. Zhang, Y. Cui, F. Zheng, and X. Jing, "Integrated sensing and communication-enabled predictive beamforming with deep learning in vehicular networks," *IEEE Commun. Lett.*, vol. 25, no. 10, pp. 3301–3304, Oct. 2021.
- [85] A. Tang, S. Li, and X. Wang, "Self-interference-resistant IEEE 802.11ad-based joint communication and automotive radar design," *IEEE J. Sel. Topics Signal Process.*, vol. 15, no. 6, pp. 1484–1499, Nov. 2021.
- [86] Z. Xiao and Y. Zeng, "Full-duplex integrated sensing and communication: Waveform design and performance analysis," in *Proc. 13th Int. Conf. Wireless Commun. Signal Process. (WCSP)*, Oct. 2021, pp. 1–5.
- [87] Z. Xiao and Y. Zeng, "Waveform design and performance analysis for full-duplex integrated sensing and communication," *IEEE J. Sel. Areas Commun.*, vol. 40, no. 6, pp. 1823–1837, Jun. 2022.
- [88] M. Chiani, A. Giorgetti, and E. Paolini, "Sensor radar for object tracking," *Proc. IEEE*, vol. 106, no. 6, pp. 1022–1041, Jun. 2018.
- [89] J. M. Park, J. Cho, S. Noh, and H. Yu, "Optimal pilot and data power allocation for joint communication-radar air-to-ground networks," *IEEE Access*, vol. 10, pp. 52336–52342, 2022.
- [90] L. Yin and B. Clerckx, "Rate-splitting multiple access for dual-functional radar-communication satellite systems," in *Proc. IEEE Wireless Commun. Netw. Conf. (WCNC)*, Apr. 2022, pp. 1–6.
- [91] L. Pucci, E. Matricardi, E. Paolini, W. Xu, and A. Giorgetti, "Performance analysis of a bistatic joint sensing and communication system," in *Proc. IEEE Int. Conf. Commun. Workshops (ICC Workshops)*, May 2022, pp. 73–78.
- [92] S. Lu, F. Liu, and L. Hanzo, "The degrees-of-freedom in monostatic ISAC channels: NLoS exploitation vs. reduction," *IEEE Trans. Veh. Technol.*, vol. 72, no. 2, pp. 2643–2648, Feb. 2023.
- [93] Y. Ma, G. Zhou, and S. Wang, "WiFi sensing with channel state information: A survey," *ACM Comput. Surv.*, vol. 52, no. 3, pp. 1–36, Jun. 2019.
- [94] V. M. Chiriach, Q. He, A. M. Haimovich, and R. S. Blum, "Ziv-Zakai bound for joint parameter estimation in MIMO radar systems," *IEEE Trans. Signal Process.*, vol. 63, no. 18, pp. 4956–4968, Sep. 2015.
- [95] A. Weiss and E. Weinstein, "A lower bound on the mean-square error in random parameter estimation (Corresp.)," *IEEE Trans. Inf. Theory*, vol. IT-31, no. 5, pp. 680–682, Sep. 1985.
- [96] C. Hue, J.-P. Le Cadre, and P. Perez, "Posterior Cramer-Rao bounds for multi-target tracking," *IEEE Trans. Aerosp. Electron. Syst.*, vol. 42, no. 1, pp. 37–49, Jan. 2006.
- [97] A. Liu, Z. Huang, M. Li, Y. Wan, W. Li, T. X. Han, C. Liu, R. Du, D. K. P. Tan, J. Lu, Y. Shen, F. Colone, and K. Chetty, "A survey on fundamental limits of integrated sensing and communication," *IEEE Commun. Surveys Tuts.*, vol. 24, no. 2, pp. 994–1034, 2nd Quart., 2022.
- [98] D. Tse and P. Viswanath, *Fundamentals of Wireless Communication*. Cambridge, U.K.: Cambridge Univ. Press, May 2005.
- [99] F. Nassar, K. Singh, S. Prakriya, B. Hazarika, C.-P. Li, and Z. Ding, "Dynamic user clustering and backscatter-enabled RIS-assisted NOMA ISAC," *IEEE Trans. Wireless Commun.*, vol. 23, no. 8, pp. 9173–9189, Aug. 2024.

- [100] C. Jiang, C. Zhang, C. Huang, J. Ge, M. Debbah, and C. Yuen, "Exploiting RIS in secure beamforming design for NOMA-assisted integrated sensing and communication," *IEEE Internet Things J.*, vol. 11, no. 17, pp. 28123–28136, Sep. 2024.
- [101] D. Li, Z. Yang, N. Zhao, Z. Wu, and T. Q. S. Quek, "NOMA aided secure transmission for IRS-ISAC," *IEEE Trans. Wireless Commun.*, vol. 23, no. 9, pp. 10911–10925, Sep. 2024.
- [102] Y. Wang, Z. Yang, J. Cui, P. Xu, G. Chen, T. Q. S. Quek, and R. Tafazolli, "Optimizing the fairness of STAR-RIS and NOMA assisted integrated sensing and communication systems," *IEEE Trans. Wireless Commun.*, vol. 23, no. 6, pp. 5895–5907, Jun. 2024.
- [103] A. S. Parihar, K. Singh, V. Bhatia, C.-P. Li, and T. Q. Duong, "Performance analysis of NOMA-enabled active RIS-aided MIMO heterogeneous IoT networks with integrated sensing and communication," *IEEE Internet Things J.*, vol. 11, no. 17, pp. 28137–28152, Sep. 2024.
- [104] J. Zhang, J. Xu, W. Lu, N. Zhao, X. Wang, and D. Niyato, "Secure transmission for IRS-aided UAV-ISAC networks," *IEEE Trans. Wireless Commun.*, vol. 23, no. 9, pp. 12256–12269, Sep. 2024.
- [105] W. Lyu, Y. Xiu, X. Li, S. Yang, P. L. Yeoh, Y. Li, and Z. Zhang, "Hybrid NOMA assisted integrated sensing and communication via RIS," *IEEE Trans. Veh. Technol.*, vol. 73, no. 5, pp. 7368–7373, May 2024.
- [106] N. Xue, X. Mu, Y. Liu, and Y. Chen, "NOMA-assisted full space STAR-RIS-ISAC," *IEEE Trans. Wireless Commun.*, vol. 23, no. 8, pp. 8954–8968, Aug. 2024.
- [107] Z. Yu, X. Hu, C. Liu, and M. Peng, "IRS-aided non-orthogonal ISAC systems: Performance analysis and beamforming design," *IEEE Trans. Green Commun. Netw.*, vol. 8, no. 4, pp. 1930–1942, Dec. 2024.
- [108] Y. Gou, Y. Ye, G. Lu, L. Lv, and R. Q. Hu, "Is the performance of NOMA-aided integrated sensing and multicast-unicast communications improved by IRS?" in *Proc. IEEE Int. Conf. Commun. Workshops (ICC Workshops)*, May 2023, pp. 219–224.
- [109] J. Zuo, Y. Liu, C. Zhu, Y. Zou, D. Zhang, and N. Al-Dhahir, "Exploiting NOMA and RIS in integrated sensing and communication," *IEEE Trans. Veh. Technol.*, vol. 72, no. 10, pp. 12941–12955, Oct. 2023.
- [110] J. Zuo and Y. Liu, "Reconfigurable intelligent surface assisted NOMA empowered integrated sensing and communication," in *Proc. IEEE Globecom Workshops (GC Wkshps)*, Dec. 2022, pp. 1028–1033.
- [111] G. Yang, X. Xu, and Y.-C. Liang, "Intelligent reflecting surface assisted non-orthogonal multiple access," in *Proc. IEEE Wireless Commun. Netw. Conf. (WCNC)*, May 2020, pp. 1–6.
- [112] T.-A. Nguyen, H.-V. Nguyen, D.-T. Do, and S. N. Sur, "Performance analysis of two IRS-NOMA users in downlink," in *Advances in Communication, Devices and Networking*, Cham, Switzerland: Springer, 2023, pp. 661–674.
- [113] D. Sarkar, Yogita, S. S. Yadav, V. Pal, N. Kumar, and S. K. Patra, "A comprehensive survey on IRS-assisted NOMA-based 6G wireless network: Design perspectives, challenges and future directions," *IEEE Trans. Netw. Service Manage.*, vol. 21, no. 2, pp. 2539–2562, Apr. 2024.
- [114] S. Kumar, P. Yadav, M. Kaur, and R. Kumar, "A survey on IRS NOMA integrated communication networks," *Telecommun. Syst.*, vol. 80, no. 2, pp. 277–302, Apr. 2022.
- [115] K. Wang, J. Cui, Z. Ding, and P. Fan, "Stackelberg game for user clustering and power allocation in millimeter wave-NOMA systems," *IEEE Trans. Wireless Commun.*, vol. 18, no. 5, pp. 2842–2857, May 2019.
- [116] J. Zhu, Y. Huang, J. Wang, K. Navaie, and Z. Ding, "Power efficient IRS-assisted NOMA," *IEEE Trans. Commun.*, vol. 69, no. 2, pp. 900–913, Feb. 2021.
- [117] Q. Wu and R. Zhang, "Intelligent reflecting surface enhanced wireless network via joint active and passive beamforming," *IEEE Trans. Wireless Commun.*, vol. 18, no. 11, pp. 5394–5409, Nov. 2019.
- [118] Z. Ding, F. Adachi, and H. V. Poor, "The application of MIMO to non-orthogonal multiple access," *IEEE Trans. Wireless Commun.*, vol. 15, no. 1, pp. 537–552, Jan. 2016.
- [119] N. Baskar, P. Selvaprabhu, V. B. Kumaravelu, S. Chinnadurai, V. Rajamani, V. Menon U, and V. Kumar C, "A survey on resource allocation and energy efficient maximization for IRS-aided MIMO wireless communication," *IEEE Access*, vol. 12, pp. 85423–85454, 2024.
- [120] L. Dai, B. Wang, Z. Ding, Z. Wang, S. Chen, and L. Hanzo, "A survey of non-orthogonal multiple access for 5G," *IEEE Commun. Surveys Tuts.*, vol. 20, no. 3, pp. 2294–2323, 3rd Quart., 2018.
- [121] B. Zheng and R. Zhang, "Intelligent reflecting surface-enhanced OFDM: Channel estimation and reflection optimization," *IEEE Wireless Commun. Lett.*, vol. 9, no. 4, pp. 518–522, Apr. 2020.
- [122] Y. Liu, X. Liu, X. Mu, T. Hou, J. Xu, M. Di Renzo, and N. Al-Dhahir, "Reconfigurable intelligent surfaces: Principles and opportunities," *IEEE Commun. Surveys Tuts.*, vol. 23, no. 3, pp. 1546–1577, 3rd Quart., 2021.
- [123] W. Zhong, Z. Yu, Y. Wu, F. Zhou, Q. Wu, and N. Al-Dhahir, "Resource allocation for an IRS-assisted dual-functional radar and communication system: Energy efficiency maximization," *IEEE Trans. Green Commun. Netw.*, vol. 7, no. 1, pp. 469–482, Mar. 2023.
- [124] M. Zhu, P. Chen, L. Yang, A.-A. A. Boulogeorgos, T. A. Tsiftsis, and H. Liu, "Active-RIS-Aided covert communications in NOMA-inspired ISAC wireless systems," 2024, *arXiv:2407.00579*.
- [125] A. Magbool, H. Sarridddeen, N. Kouzayha, M.-S. Alouini, and T. Y. Al-Naffouri, "Terahertz-band non-orthogonal multiple access: System- and link-level considerations," *IEEE Wireless Commun.*, vol. 30, no. 1, pp. 142–149, Feb. 2023.
- [126] P. Vishwakarma, D. Bhattacharjee, S. Dhar, and S. N. Sur, "A comprehensive review on beamforming optimization techniques for IRS assisted energy harvesting," *Arch. Comput. Methods Eng.*, vol. 2024, pp. 1–69, May 2024.
- [127] Z. Wei, C. Masouros, and F. Liu, "Secure directional modulation with few-bit phase shifters: Optimal and iterative-closed-form designs," *IEEE Trans. Commun.*, vol. 69, no. 1, pp. 486–500, Jan. 2021.
- [128] C. Huang, S. Hu, G. C. Alexandropoulos, A. Zappone, C. Yuen, R. Zhang, M. D. Renzo, and M. Debbah, "Holographic MIMO surfaces for 6G wireless networks: Opportunities, challenges, and trends," *IEEE Wireless Commun.*, vol. 27, no. 5, pp. 118–125, Oct. 2020.
- [129] N. Shlezinger, G. C. Alexandropoulos, M. F. Imani, Y. C. Eldar, and D. R. Smith, "Dynamic metasurface antennas for 6G extreme massive MIMO communications," *IEEE Wireless Commun.*, vol. 28, no. 2, pp. 106–113, Apr. 2021.
- [130] M. Nemati, Y. H. Kim, and J. Choi, "Toward joint radar, communication, computation, localization, and sensing in IoT," *IEEE Access*, vol. 10, pp. 11772–11788, 2022.
- [131] Ö. T. Demir, E. Björnson, and L. Sanguinetti, "Foundations of user-centric cell-free massive MIMO," *Found. Trends Signal Process.*, vol. 14, nos. 3–4, pp. 162–472, 2021.
- [132] X. Wang, Z. Fei, J. Huang, and H. Yu, "Joint waveform and discrete phase shift design for RIS-assisted integrated sensing and communication system under Cramer–Rao bound constraint," *IEEE Trans. Veh. Technol.*, vol. 71, no. 1, pp. 1004–1009, Jan. 2022.
- [133] H. Luo, R. Liu, M. Li, Y. Liu, and Q. Liu, "Joint beamforming design for RIS-assisted integrated sensing and communication systems," *IEEE Trans. Veh. Technol.*, vol. 71, no. 12, pp. 13393–13397, Dec. 2022.
- [134] Z. Qin, Y. Liu, Z. Ding, Y. Gao, and M. ElKashlan, "Physical layer security for 5G non-orthogonal multiple access in large-scale networks," in *Proc. IEEE Int. Conf. Commun. (ICC)*, May 2016, pp. 1–6.
- [135] L. Hu, X. Zheng, and C. Chen, "Physical layer security in nonorthogonal multiple access wireless network with jammer selection," *Secur. Commun. Netw.*, vol. 2019, pp. 1–9, Nov. 2019.
- [136] M. Wijewardena, T. Samarasinghe, K. T. Hemachandra, S. Atapattu, and J. S. Evans, "Physical layer security for intelligent reflecting surface assisted two-way communications," *IEEE Commun. Lett.*, vol. 25, no. 7, pp. 2156–2160, Jul. 2021.
- [137] D. Li, H. Yang, Z. Yang, N. Zhao, Z. Wu, and T. Q. S. Quek, "NOMA-enhanced IRS-ISAC: A security approach," in *Proc. IEEE Wireless Commun. Netw. Conf. (WCNC)*, Apr. 2024, pp. 1–6.
- [138] K. Meng, Q. Wu, J. Xu, W. Chen, Z. Feng, R. Schober, and A. L. Swindlehurst, "UAV-enabled integrated sensing and communication: Opportunities and challenges," *IEEE Wireless Commun.*, vol. 31, no. 2, pp. 97–104, Apr. 2024.

- [139] X. Song, D. Zhao, H. Hua, T. X. Han, X. Yang, and J. Xu, "Joint transmit and reflective beamforming for IRS-assisted integrated sensing and communication," in *Proc. IEEE Wireless Commun. Netw. Conf. (WCNC)*, Apr. 2022, pp. 189–194.
- [140] R. Liu, M. Li, Y. Liu, Q. Wu, and Q. Liu, "Joint transmit waveform and passive beamforming design for RIS-aided DFRC systems," *IEEE J. Sel. Topics Signal Process.*, vol. 16, no. 5, pp. 995–1010, Aug. 2022.
- [141] Z.-M. Jiang, M. Rihan, P. Zhang, L. Huang, Q. Deng, J. Zhang, and E. M. Mohamed, "Intelligent reflecting surface aided dual-function radar and communication system," *IEEE Syst. J.*, vol. 16, no. 1, pp. 475–486, Mar. 2022.
- [142] N. Su, F. Liu, and C. Masouros, "Secure radar-communication systems with malicious targets: Integrating radar, communications and jamming functionalities," *IEEE Trans. Wireless Commun.*, vol. 20, no. 1, pp. 83–95, Jan. 2021.
- [143] F. Naeem, M. Ali, G. Kaddoum, C. Huang, and C. Yuen, "Security and privacy for reconfigurable intelligent surface in 6G: A review of prospective applications and challenges," *IEEE Open J. Commun. Soc.*, vol. 4, pp. 1196–1217, 2023.
- [144] S. Buzzi, E. Grossi, M. Lops, and L. Venturino, "Foundations of MIMO radar detection aided by reconfigurable intelligent surfaces," *IEEE Trans. Signal Process.*, vol. 70, pp. 1749–1763, 2022.
- [145] F. Wang, H. Li, and J. Fang, "Joint active and passive beamforming for IRS-assisted radar," *IEEE Signal Process. Lett.*, vol. 29, pp. 349–353, 2022.
- [146] A. M. Elbir, K. V. Mishra, and S. Chatzinotas, "Terahertz-band joint ultra-massive MIMO radar-communications: Model-based and model-free hybrid beamforming," *IEEE J. Sel. Topics Signal Process.*, vol. 15, no. 6, pp. 1468–1483, Nov. 2021.
- [147] A. M. Elbir, K. V. Mishra, M. R. B. Shankar, and S. Chatzinotas, "The rise of intelligent reflecting surfaces in integrated sensing and communications paradigms," *IEEE Netw.*, vol. 37, no. 6, pp. 224–231, Nov. 2023.
- [148] G. N. Saddik, R. S. Singh, and E. R. Brown, "Ultra-wideband multifunctional communications/radar system," *IEEE Trans. Microw. Theory Techn.*, vol. 55, no. 7, pp. 1431–1437, Jul. 2007.
- [149] L. Han and K. Wu, "Joint wireless communication and radar sensing systems—State of the art and future prospects," *IET Microw., Antennas Propag.*, vol. 7, no. 11, pp. 876–885, Aug. 2013.
- [150] T. Wei, L. Wu, K. V. Mishra, and M. R. B. Shankar, "Multiple IRS-assisted wideband dual-function radar-communication," in *Proc. 2nd IEEE Int. Symp. Joint Commun. Sens. (JC&S)*, Mar. 2022, pp. 1–5.
- [151] C. Liao and F. Wang, "Beamforming design for IRS-assisted integrated sensing and communication systems in clutter environments," in *Proc. IEEE 24th Int. Workshop Signal Process. Adv. Wireless Commun. (SPAWC)*, Sep. 2023, pp. 96–100.
- [152] Z. Liu, L. Zhang, and Z. Ding, "Exploiting bi-directional channel reciprocity in deep learning for low rate massive MIMO CSI feedback," *IEEE Wireless Commun. Lett.*, vol. 8, no. 3, pp. 889–892, Jun. 2019.
- [153] Y. Wang, P. Xu, and Z. Tian, "Efficient channel estimation for massive MIMO systems via truncated two-dimensional atomic norm minimization," in *Proc. IEEE Int. Conf. Commun. (ICC)*, May 2017, pp. 1–6.
- [154] C. Shi, S. Salous, F. Wang, and J. Zhou, "Low probability of intercept-based adaptive radar waveform optimization in signal-dependent clutter for joint radar and cellular communication systems," *EURASIP J. Adv. Signal Process.*, vol. 2016, no. 1, pp. 1–13, Oct. 2016.
- [155] N. González-Prelcic, R. Méndez-Rial, and R. W. Heath Jr., "Radar aided beam alignment in MmWave V2I communications supporting antenna diversity," in *Proc. Inf. Theory Appl. Workshop (ITA)*, Jan. 2016, pp. 1–7.
- [156] H. Xu, W. Yu, D. Griffith, and N. Golmie, "A survey on industrial Internet of Things: A cyber-physical systems perspective," *IEEE Access*, vol. 6, pp. 78238–78259, 2018.
- [157] J. Wang, N. Varshney, C. Gentile, S. Blandino, J. Chuang, and N. Golmie, "Integrated sensing and communication: Enabling techniques, applications, tools and data sets, standardization, and future directions," *IEEE Internet Things J.*, vol. 9, no. 23, pp. 23416–23440, Dec. 2022.
- [158] C. You, B. Zheng, and R. Zhang, "Channel estimation and passive beamforming for intelligent reflecting surface: Discrete phase shift and progressive refinement," *IEEE J. Sel. Areas Commun.*, vol. 38, no. 11, pp. 2604–2620, Nov. 2020.
- [159] C. You, B. Zheng, and R. Zhang, "Intelligent reflecting surface with discrete phase shifts: Channel estimation and passive beamforming," in *Proc. IEEE Int. Conf. Commun. (ICC)*, Jun. 2020, pp. 1–6.
- [160] W. Yang, H. Li, M. Li, Y. Liu, and Q. Liu, "Channel estimation for practical IRS-assisted OFDM systems," in *Proc. IEEE Wireless Commun. Netw. Conf. Workshops (WCNCW)*, Mar. 2021, pp. 1–6.
- [161] J. Xu, W. Xu, and A. L. Swindlehurst, "Discrete phase shift design for practical large intelligent surface communication," in *Proc. IEEE Pacific Rim Conf. Commun., Comput. Signal Process. (PACRIM)*, Aug. 2019, pp. 1–5.
- [162] Q. Wu and R. Zhang, "Beamforming optimization for wireless network aided by intelligent reflecting surface with discrete phase shifts," *IEEE Trans. Commun.*, vol. 68, no. 3, pp. 1838–1851, Mar. 2020.
- [163] B. Di, H. Zhang, L. Song, Y. Li, Z. Han, and H. V. Poor, "Hybrid beamforming for reconfigurable intelligent surface based multi-user communications: Achievable rates with limited discrete phase shifts," *IEEE J. Sel. Areas Commun.*, vol. 38, no. 8, pp. 1809–1822, Aug. 2020.
- [164] E. Björnson, H. Wymeersch, B. Matthieson, P. Popovski, L. Sanguinetti, and E. de Carvalho, "Reconfigurable intelligent surfaces: A signal processing perspective with wireless applications," *IEEE Signal Process. Mag.*, vol. 39, no. 2, pp. 135–158, Mar. 2022.
- [165] S. Abeywickrama, R. Zhang, Q. Wu, and C. Yuen, "Intelligent reflecting surface: Practical phase shift model and beamforming optimization," *IEEE Trans. Commun.*, vol. 68, no. 9, pp. 5849–5863, Sep. 2020.
- [166] F. Costa and M. Borgese, "Electromagnetic model of reflective intelligent surfaces," *IEEE Open J. Commun. Soc.*, vol. 2, pp. 1577–1589, 2021.
- [167] H. Sarrideen, N. Saeed, T. Y. Al-Naffouri, and M.-S. Alouini, "Next generation terahertz communications: A rendezvous of sensing, imaging, and localization," *IEEE Commun. Mag.*, vol. 58, no. 5, pp. 69–75, May 2020.
- [168] D. Ma, N. Shlezinger, T. Huang, Y. Liu, and Y. C. Eldar, "Joint radar-communication strategies for autonomous vehicles: Combining two key automotive technologies," *IEEE Signal Process. Mag.*, vol. 37, no. 4, pp. 85–97, Jul. 2020.
- [169] X. Jing, F. Liu, C. Masouros, and Y. Zeng, "ISAC from the sky: UAV trajectory design for joint communication and target localization," *IEEE Trans. Wireless Commun.*, vol. 23, no. 10, pp. 12857–12872, Oct. 2024.
- [170] K. Keykhosravi, B. Denis, G. C. Alexandropoulos, Z. S. He, A. Albanese, V. Sciancalepore, and H. Wymeersch, "Leveraging ris-enabled smart signal propagation for solving infeasible localization problems: Scenarios, key research directions, and open challenges," *IEEE Veh. Technol. Mag.*, vol. 18, no. 2, pp. 20–28, Jun. 2023.
- [171] M. Vahidpour and K. Sarabandi, "Millimeter wave RCS and Doppler spectrum of walking human and dog," in *Proc. IEEE Antennas Propag. Soc. Int. Symp.*, Jun. 2007, pp. 4004–4007.
- [172] S. Sundar Ram and H. Ling, "Simulation of human microDopplers using computer animation data," in *Proc. IEEE Radar Conf.*, May 2008, pp. 1–6.
- [173] C. De Lima, D. Belot, R. Berkvens, A. Bourdoux, D. Dardari, M. Guillaud, M. Isomursu, E.-S. Lohan, Y. Miao, A. N. Barreto, M. R. K. Aziz, J. Saloranta, T. Sanguanpuak, H. Sarrideen, G. Seco-Granados, J. Suutala, T. Svensson, M. Valkama, B. Van Liempd, and H. Wymeersch, "Convergent communication, sensing and localization in 6G systems: An overview of technologies, opportunities and challenges," *IEEE Access*, vol. 9, pp. 26902–26925, 2021.
- [174] W. G. Hatcher and W. Yu, "A survey of deep learning: Platforms, applications and emerging research trends," *IEEE Access*, vol. 6, pp. 24411–24432, 2018.
- [175] Y. Liu, J. Wang, J. Li, S. Niu, and H. Song, "Machine learning for the detection and identification of Internet of Things devices: A survey," *IEEE Internet Things J.*, vol. 9, no. 1, pp. 298–320, Jan. 2022.
- [176] S. Goel and R. Negi, "Guaranteeing secrecy using artificial noise," *IEEE Trans. Wireless Commun.*, vol. 7, no. 6, pp. 2180–2189, Jun. 2008.
- [177] M. Nemati, S. R. Pokhrel, and J. Choi, "Modelling data aided sensing with UAVs for efficient data collection," *IEEE Wireless Commun. Lett.*, vol. 10, no. 9, pp. 1959–1963, Sep. 2021.
- [178] J. Choi, "Data-aided sensing for Gaussian process regression in IoT systems," *IEEE Internet Things J.*, vol. 8, no. 9, pp. 7717–7726, May 2021.



SAMARENDRA NATH SUR (Senior Member, IEEE) received the M.Tech. degree in digital electronics and advanced communication from Sikkim Manipal University, in 2012, and the Ph.D. degree in MIMO signal processing from the National Institute of Technology (NIT), Durgapur, in 2019. Since 2008, he has been associated with Sikkim Manipal Institute of Technology, India, where he is currently an Assistant Professor (SG) with the Department of Electronics and Communication Engineering. He has published more than 120 SCI/Scopus indexed international journal and conference papers. His current research interests include wireless communications, non-orthogonal multiple access (NOMA), energy harvesting (EH), intelligent reflecting surface (IRS), the Internet of Things (IoT) and remote sensing, and radar image/signal processing (soft computing). He is a member of the IEEE-IoT and Institution of Engineers (India) (IEI). He is also serving as an Associate Editor for *International Journal on Smart Sensing and Intelligent Systems* (S2IS) (SCOPUS, ESCI). Additionally, he had the privilege of serving as the Guest Editor for topical collections and special issues in reputable journals published by Springer Nature, MDPI, and Hindawi.



ARUN KUMAR SINGH (Member, IEEE) received the B.Tech. degree in electronics and communication engineering and the master's degree in digital electronics and advanced communications from Sikkim Manipal Institute of Technology, Sikkim Manipal University, in 2009 and 2012, respectively, and the Ph.D. degree in beamforming for sensing and communication toward intelligent transportation system from the National Institute of Technology, Durgapur, in 2024. He is has been an Assistant Professor with the Department of Electronics and Communication Engineering, Sikkim Manipal Institute of Technology, Sikkim Manipal University, since 2012. He has published more than 30 research papers in international/national journals and conferences. His research interests include antenna and signal processing.



HUU Q. TRAN (Member, IEEE) received the M.S. degree in electronics engineering from Ho Chi Minh City University of Technology and Education (HCMUTE), Vietnam, in 2010, and the Ph.D. degree from the Faculty of Electrical and Electronics Engineering, HCMUTE. He is currently a Lecturer with the Faculty of Electronics Technology, Industrial University of Ho Chi Minh City (IUH), Vietnam. His research interests include wireless communications, non-orthogonal multiple access (NOMA), energy harvesting (EH), wireless cooperative relaying networks, cognitive radio (CR), heterogeneous networks (HetNet), cloud radio access networks (C-RAN), unmanned aerial vehicles (UAV), reconfigurable intelligent surfaces (RIS), short-packet communication (SPC), and the Internet of Things (IoT).



PRADEEP VISHWAKARMA received the B.Tech. degree in electronics and communication engineering from the RCC Institute of Information Technology, West Bengal, India, in 2015, and the M.Tech. degree in electronics and communication engineering from the MCKV Institute of Engineering, West Bengal, in 2020. He is currently pursuing the Ph.D. degree in electronics and communication engineering with Sikkim Manipal Institute of Technology, Sikkim, India. His current research interests include intelligent reflecting surface (IRS)/reconfigurable intelligent surface (RIS), SWIPT, wireless energy harvesting, MIMO, NOMA, and wireless communications.



AGBOTINAME LUCKY IMOIZE (Senior Member, IEEE) has been a Research Scholar with Ruhr University, Bochum, Germany, under the sponsorship of Nigerian Petroleum Technology Development Fund (PTDF) and German Academic Exchange Service (DAAD) through Nigerian-German Postgraduate Program. He is currently a Marie Skłodowska-Curie Fellow with the Consorzio Nazionale Interuniversitario per le Telecomunicazioni (CNIT) and the Politecnico di Torino, Italy. He is a Lecturer with the Department of Electrical and Electronics Engineering, University of Lagos, Nigeria. Before joining the University of Lagos, he was a Lecturer with the Bells University of Technology, Nigeria. He previously worked as a Core Network Products Manager of ZTE, Nigeria, and a Network Switching Subsystem Engineer with Globacom, Nigeria. His research interests include 6G wireless communications, reconfigurable holographic surfaces, wireless security systems, and artificial intelligence. He was awarded the Fulbright Fellowship as a Visiting Researcher with the Wireless@VT Laboratory, Bradley Department of Electrical and Computer Engineering, Virginia Tech, USA. He is the Vice Chair of the IEEE Communication Society Nigeria Chapter and a Registered Engineer with the Council for the Regulation of Engineering in Nigeria.



CHUN-TA LI (Senior Member, IEEE) received the Ph.D. degree in computer science and engineering from National Chung Hsing University, Taiwan, in 2008. He was formerly a full-time Professor with the Department of Information Management, Tainan University of Technology. He is currently a full-time Professor with the Program of Artificial Intelligence and Information Security, Fu Jen Catholic University, New Taipei City, Taiwan. His research interests include information security, wireless sensor networks, mobile computing, and security protocols for the IoTs and ad hoc networks. He has published more than 100 international journal articles and international conference papers on the above research fields. He received the 2011 IJICIC Most Cited Paper Award from the *International Journal of Innovative Computing, Information and Control*. He also served as a reviewer for many SCI-index journals.

...