

Evaluation of the influence of rain on air surface temperature measurements

Original

Evaluation of the influence of rain on air surface temperature measurements / Nielsen, Jan; Bottacin, Alberto; Østergaard, Peter; Nielsen, Tommy; Rasmussen, Morten Karstoft; Musacchio, Chiara; Coppa, Graziano; Merlone, Andrea. - In: MEASUREMENT SCIENCE & TECHNOLOGY. - ISSN 0957-0233. - 36:2(2025), pp. 1-8. [10.1088/1361-6501/ada1ea]

Availability:

This version is available at: 11583/2996303 since: 2025-01-07T12:30:33Z

Publisher:

IOP Publishing

Published

DOI:10.1088/1361-6501/ada1ea

Terms of use:

This article is made available under terms and conditions as specified in the corresponding bibliographic description in the repository

Publisher copyright

(Article begins on next page)

PAPER • OPEN ACCESS

Evaluation of the influence of rain on air surface temperature measurements

To cite this article: Jan Nielsen *et al* 2025 *Meas. Sci. Technol.* **36** 025801

View the [article online](#) for updates and enhancements.

You may also like

- [Optimized path planning for underground coal mine filling: an greedy adaptive directional bidirectional rapidly-exploring random tree](#)
Zihang Zhang, Yang Liu, Lei Bo et al.

- [Advancing machine fault diagnosis: a detailed examination of convolutional neural networks](#)
Govind Vashishtha, Sumika Chauhan, Mert Sehri et al.

- [Research on a cloud-edge collaborative adaptive detection system for AC series arc faults](#)
Guanghai Bao, Zhaorui Wang and Jiantao He



UNITED THROUGH SCIENCE & TECHNOLOGY

ECS The Electrochemical Society
Advancing solid state & electrochemical science & technology

**248th
ECS Meeting
Chicago, IL
October 12-16, 2025
Hilton Chicago**

**Science +
Technology +
YOU!**

**SUBMIT
ABSTRACTS by
March 28, 2025**

SUBMIT NOW

Evaluation of the influence of rain on air surface temperature measurements

Jan Nielsen¹, Alberto Bottacin^{2,3,*} , Peter Østergaard¹, Tommy Nielsen¹, Morten Karstoft Rasmussen¹, Chiara Musacchio² , Graziano Coppa²  and Andrea Merlone² 

¹ Danish Technological Institute, Taastrup, Denmark

² Istituto Nazionale di Ricerca Metrologica, Turin, Italy

³ Politecnico di Torino, Turin, Italy

E-mail: a.bottacin@inrim.it

Received 6 September 2024, revised 4 December 2024

Accepted for publication 20 December 2024

Published 31 December 2024



CrossMark

Abstract

Reliable measurements of surface air temperature are crucial in meteorology and climatology. Thermometers must be shielded to avoid atmospheric influence factors, such as solar radiation and rainfall, compromise their accuracy. In the standard document ISO 17714, which defines test methods for performance comparison of different screens, potential error sources caused by rainfall are mentioned. Besides the well-known psychrometric effect, an error on the temperature reading related to the difference between air and rain temperature causing heat transfer from water to the thermometer is identified. Despite the high relevance, no studies are available in literature that analyze this effect. The work described in this paper aims at quantifying the influence of the rain on the readings of temperature sensors, with radiation screens of different types. The study was performed by introducing an artificial rainfall generator where the water temperature and rain intensity was controlled and comparing the readings of thermometers under the generated rainfall with respect to a developed reference system not affected by rain. The tests show that the error for especially naturally ventilated thermometers can be unacceptably large, up to -4.0 (0.2) K, whereas for the artificially ventilated air thermometers the errors observed are less significant, smaller than -1.1 (0.2) K. This preliminary study underscores the critical influence of rain temperature and intensity on thermometer readings and highlights the importance of further research to develop standardized testing protocols. The reported methodology can also help to develop future standardized test protocol to qualify the device with regards to the measurement error.

Keywords: rain temperature, metrology, air temperature, rain generator

1. Introduction

Near-surface atmospheric air temperature is a key variable in meteorology and climatology. Atmospheric factors, such as

wind, rainfall, solar radiation and relative humidity influence the air temperature measurement, thus compromising the accuracy of meteorological thermometers. One of the most studied effects is the over-heating of the sensor due to solar radiation, which produces an error on the air temperature measurement (World Meteorological Organization (WMO) 2018). Solar screens are used to protect the sensor and reduce the radiative error affecting the measurements, but they are not perfect and expose the thermometer to a microclimate condition which may not be representative of the ambient conditions (Lin *et al* 2001). For these reasons, field intercomparisons of artificially/naturally ventilated screens have been

* Author to whom any correspondence should be addressed.



Original content from this work may be used under the terms of the [Creative Commons Attribution 4.0 licence](https://creativecommons.org/licenses/by/4.0/). Any further distribution of this work must maintain attribution to the author(s) and the title of the work, journal citation and DOI.

conducted to analyze the error affecting the air temperature measurement inside the screen with respect to a chosen reference system (Brandsma and van der Meulen 2008, van der Meulen and Brandsma 2008). Despite these efforts, a complete uncertainty budget for air temperature is not yet defined.

A major effect causing biases and uncertainty in air temperature measurements is the influence of rain on the temperature sensor and its protecting screen. Although the psychrometric effect is well known (ISO 2007), another error on the temperature readings due to rainfall have been recognized in the standard ISO 17714 (2007), which recommends test methods for characterizing air thermometers with their radiation screen. In annex A of this documentary standard, it is written: ‘Another effect is that the temperature of the precipitation is generally lower than the temperature of the air [...] This can suddenly cool the screen at a different rate than the air (up to 5 K in 5 min)’. Even though the high impact that this effect can have on measurements, there is no further information that quantifies it and no studies are available in literature. For this reason, the work presented here aims to highlight the influence of the rain in the readings of temperature sensors in automatic weather stations, with radiation screens of different types, such as naturally and artificially ventilated.

The study is conducted by introducing an artificial rainfall generator and an adequate system to measure air temperature. The first is necessary to simulate controlled rainfall with varying water temperature and intensity, whereas the latter is needed since ‘There is no recognized reference system for measuring the true air temperature’ (ISO 17714 2007). Then the measurements of the sensors under rainfall conditions are then compared to the reference system and the results are analyzed and discussed. Finally, additional recommendations on a test method and further work are advised.

2. Methods

This section describes how the test setup has been designed and constructed, including a detailed description of the artificial rainfall simulator and of the reference system for air temperature measurement.

For practical reasons, the test setup, shown in figure 1, is built in a tarpaulin covered outdoor shaft, next to the laboratory building. The tests are performed by comparing sensors, with screens of different manufacturers and operating under rainfall conditions, with respect to the reference system, which is used to accurately measure air temperature in dry condition.

The operating principle of the test set-up is described here following. Tap-water is used for the rainfall generator and its temperature is controlled for testing at different rain temperatures. Cooling of water is performed by means of a plate heat-exchanger connected to a brine cooling system. The resulting water temperature, T_w , is monitored using a PT500 sensor. Experiments are performed with water temperatures between 6 °C and 14 °C. The flow rate is controlled with a manual control valve regulating the water supply pressure and

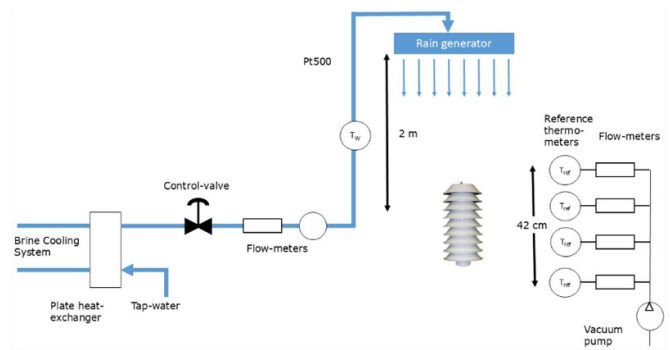

Figure 1. Schematics of the set-up for testing the performance of meteorological air-thermometers under influence of rain.

checked with a flowmeter. The accumulated volume is also measured with a mechanical flow meter. The air temperature is not controlled. Meteorological thermometers of different design are placed under the rainfall simulator and measurements are made relative to the reference system. The latter consists of four aspirated thermometers, designed and constructed at Danish Technological Institute (DTI). The aspiration is obtained through a vacuum pump, whereas the flow rate is controlled with a valve and measured with a flowmeter. The reference thermometers are positioned beside the device under test (DUT) for measuring the air temperature but protected from being directly exposed to the rain.

All the equipment used for the measurements is placed in a waterproof box. For data acquisition a LabVIEW® program is developed, whereas data analysis is conducted using MATLAB®. Design details of the rainfall generator and of the reference system are given in sections 2.1 and 2.2.

2.1. Rain generator

The design of an artificial rain generator must ensure realistic amount of rain, which at the same time must be evenly distributed above the test area. Different approaches have been tested but it was found that using a spiral shaped perforated water hose was the best since it generates a rainfall intensity in an acceptable range and area distribution. The water hose is suspended approximately two meters above the reference thermometer setup and the DUT (see figure 2(a)). Rainfall intensities from approximately 0–100 mm h⁻¹ can be reached using this setup by regulating the water supply pressure.

The rainfall intensity corresponding to the manually set flow rate is reported in table 1. Moreover, the spatial variation of the rainfall intensity is measured. Several identical laboratory measuring cups are positioned in a matrix below the rainfall and, after a given period, the generator is shut off and the water level in each of the glasses is measured. The estimated spatial distribution of the rainfall intensity is then plotted as shown in figure 2(b). It is observed that the maximum intensity is not centered over the experimental area. Nevertheless, the DUT is placed in the center since a suitable intensity is

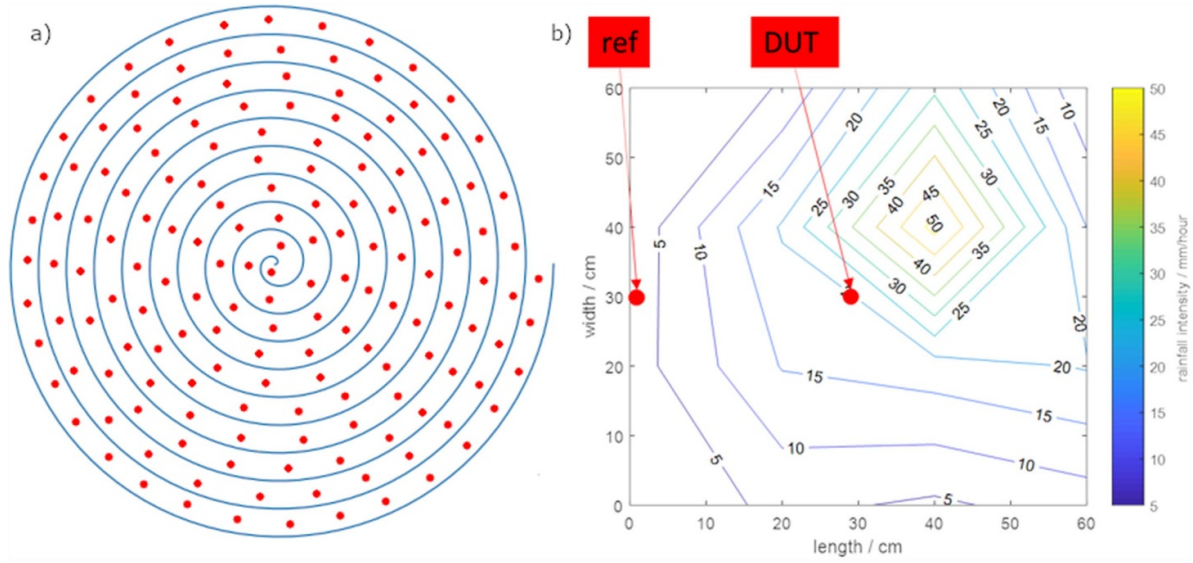

Figure 2. (a) Schematics of the rain generator. A standard water hose is perforated with equal distances between each hole and curled up in a spiral. The rain generator is placed approximately 2 meters above the reference thermometer setup and the DUT. (b) The spacial rain intensity over the rain area is measured. The red boxes ‘ref’ and ‘DUT’ indicates where the thermometer reference setup and the DUT instrument are placed, respectively.

Table 1. Estimations of the measurement error $T_{DUT} - T_{REF}$ (with associated standard uncertainty) for DUT1 and DUT2, at different rain-air temperature differences and flow rates (FR).

DUT	FR = 0.2 l min ⁻¹		FR = 0.4 l min ⁻¹		FR = 0.6 l min ⁻¹	
	$T_{DUT} - T_{REF}$	$T_W - T_{REF}$	$T_{DUT} - T_{REF}$	$T_W - T_{REF}$	$T_{DUT} - T_{REF}$	$T_W - T_{REF}$
1	-0.5 (0.1) K	-2.8 (0.8) K	-4.0 (0.2) K	-13.4 (1.4) K	-3.6 (0.3) K	-13.6 (1.2) K
2	-0.3 (0.1) K	-3.4 (0.7) K	-0.9 (0.3) K	-12.1 (1.1) K	-1.1 (0.2) K	-12.1 (1.1) K

achieved. At the boundary of the area, the intensity is below 5 mm h⁻¹, thus being a suitable spot to place the reference system. Tests were made where the position of the DUT in the rain area is changed to see if an uneven distribution of water has any effect and no significant change was found. The droplet size was not controlled or measured during the tests. As the drops were created passively, their diameter is expected to be in between 2 and 4 mm, as smaller droplets would stick to the generator, and larger droplets are unstable and will break into multiple smaller droplets.

2.2. Reference system for air temperature measurement

When constructing a contact thermometer for air temperature measurement the thermodynamics raises several general issues that need consideration to reduce measuring errors (e.g. Baker et al 1961, Michalski et al 2001). The convection heat flux from air to the sensor element must be increased and the errors by conduction and radiation must be decreased.

When constructing the reference measurement standard the following issues were taken into account:

- The time constant of the reference measurements system needs to be faster than the DUT and, because the air temperature is not actively controlled, fast enough to avoid lag errors become an issue.

- The sensor need to be sufficiently shielded to reduce radiation error.
- Using resistance thermometers, self-heating of the reference sensors is an issue.

To achieve a fast time constant and optimization of the heat flux from air to sensor the following strategy was realized: a sensor with small dimensions was chosen and the heat transfer from the air to the sensor was optimized by increasing the air-flow around the sensor. Self-heating effects were reduced by using low measuring currents for the resistance thermometers and thereby limiting the power dissipated in the sensor.

Concerning dimensions, thermistors are a good choice due to their small size and fast reaction times. Glass encapsulated thermistors have proven to be reliable in practical air temperature applications (van Geel et al 2015, Nielsen and Barendregt 2004, Bosma and Peruzzi 2014) and a guideline of the consultative committee for thermometry on the calibration, linearization, and uncertainty evaluation is available (CCT, 2014). Because of these qualities, negative temperature coefficient glass encapsulated thermistors are chosen, with a nominal resistance of 10 kΩ at 25 °C was chosen.

A Fluke 1586 A Super-DAQ Precision Temperature Scanner® is chosen as indicator since it uses a sufficiently low and constant measurement current of 10 μA, limiting

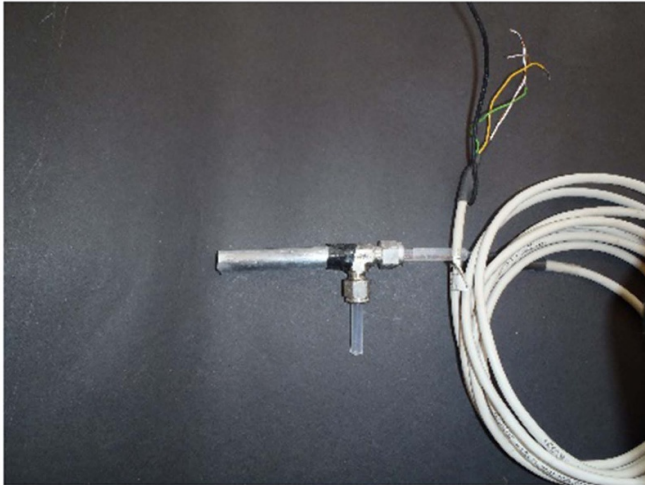

Figure 3. Picture of the reference aspirated thermometer developed by DTI.

self-heating effects. Overall, the measurement accuracy for this indicating device is specified to be ± 3 mK.

To increase the energy-transfer from the surrounding media to the sensor, an aspiration thermometer is constructed as suggested by Michalski *et al* (2001). To increase the redundancy, thus the reliability of the reference temperature data, four such thermometers are assembled and labeled as: Meteo1, Meteo2, Meteo3 and Meteo4.

Each thermistor is mounted strain-free to four varnished copper wires. The wires are then twisted together pairwise to minimize electromagnetic interference. This also results in a more rigid structure of the final sensor. The sensor is then mounted ‘straight through’ a $1/4$ ’ T-tube fitting, where the tube diameter has been widened. The end of the T from which the wire extends is sealed. Air can now be aspirated past the sensor element by connecting a pump to the remaining connector of the T fitting.

Errors due to radiation from external sources may be significant (Tegeler 2004), therefore a cylindrical radiation screen is constructed. This construction (dimensions and materials) follows the guidelines laid out in ISO 7726 (2001) and Baker *et al* (1961). The cylindrical screen is made from 0.4 mm thick sheets of reflective aluminum (low emissivity). The inner diameter of the screen is 10 mm. The inside of the cylinder is painted black by Nextel Velvet Coating 811-21® with an emissivity of approximately 0.98. A picture of the developed reference thermometer is shown in figure 3.

When air is aspirated, the heat transfer to the sensor is increased and in combination with the shielding of radiation sources, the sensor temperature should approximate the air temperature.

Before using the reference system to evaluate the effect of the rain, the four reference aspirated thermometers were calibrated by comparison to a standard platinum resistance thermometer in a liquid bath, to ensure the traceability to the national standard. The thermistors were placed during the calibration in glass tubes in still standing air to evaluate the self-heating

effect. They were also mutually validated by comparison in a climatic chamber with the set-up that is routinely used in DTI’s calibration laboratory for calibrating air temperature and relative humidity sensors (Heinonen *et al* 2013, MeteoMet 2015). The final expanded measurement uncertainty is below 10 mK for all the constructed thermometers and takes into account the calibration process (setup, least-squares fit, self-heating) and the uncertainty related to the indicator. Note that this uncertainty is strictly related to the instrument and it does not consider any effect due to quantities of influence (as it could be rain or solar radiation). The optimal flow rate was found experimentally by comparing the developed aspirated thermometers to four calibrated PT100 and a Hart Scientific Model 1560® Thermometer Readout in a climatic chamber. This set-up has been validated in the EURAMET P1061 intercomparison (Heinonen *et al* 2013). The optimal flow rate is found to be 2.5 l min^{-1} , corresponding to an air speed of about 1.3 m s^{-1} , which is used in all the experiments reported in this paper. Thanks to the larger immunity to solar radiation due to the small size of the employed thermistors, the tuned air speed is enough to guarantee a predominant heat exchange by convection, reducing possible temperature measurement interference due to radiative transfer of heat.

3. Test and results

The developed experimental setup is used to compare two different thermometers, with associated screens produced by different manufacturers, having comparable calibration uncertainty. The devices under test, shown in figure 4, are labeled DUT1 and DUT2. DUT1 is a sensor, of not specified type, shielded by a naturally ventilated screen and DUT2 is an artificially ventilated PT100 sensor. The sampling time for both sensors was set to 5 s. To investigate the influence of rain temperature and rain intensity on the performance of the devices, they were placed, one by one, under the rainfall generator and compared to the reference system in still or very slow moving air. During tests, the difference between water and air temperature is ideally kept constant (unless it is changed on purpose). It is reasonable that, as the distance between ground and the rain generator is only a few meters, the air volume exposed to rain reaches a near-thermal equilibrium when the generator is switched on. In most real-life situations, at first a fast drop in air temperature is expected, followed by an equalization between rain and air temperature, as described in Byers *et al* (1949). This should be considered when interpreting the experimental results. In the following, details on the tests performed on both devices (Nielsen *et al*, 2024) are given with the discussion on the comparison of the performances.

Starting from the DUT1 test, the rainfall intensity, set during the experiment using the control valve, is shown in figure 5. At the beginning, the generator is turned on setting a flow rate of 0.6 l min^{-1} ($\approx 20 \text{ mm h}^{-1}$), then the rate is decreased to 0.4 l min^{-1} ($\approx 15 \text{ mm h}^{-1}$) and finally to 0.2 l min^{-1} ($\approx 10 \text{ mm h}^{-1}$). The difference between water

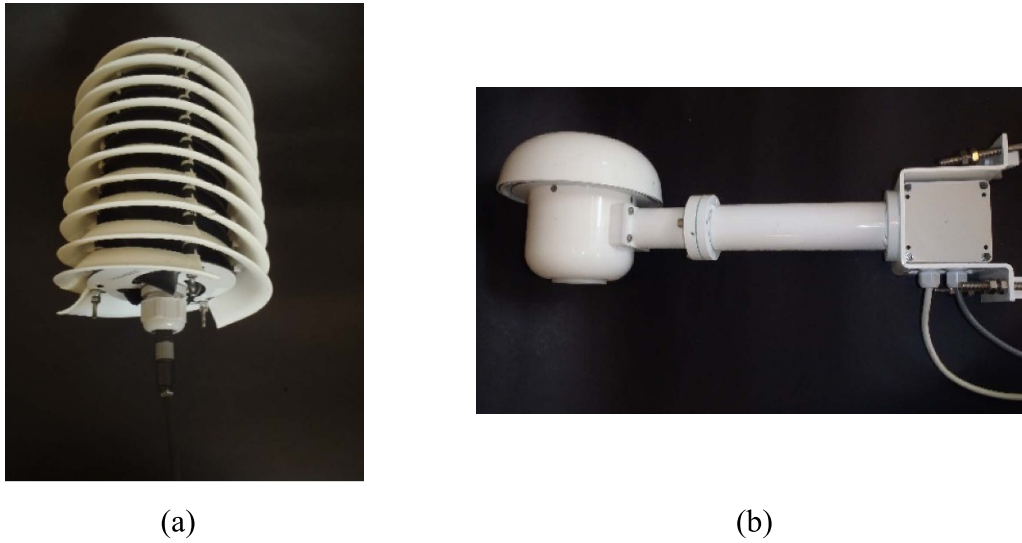

Figure 4. (a) DUT1: naturally ventilated thermometer (not specified type) (b) DUT2: artificially ventilated PT100.

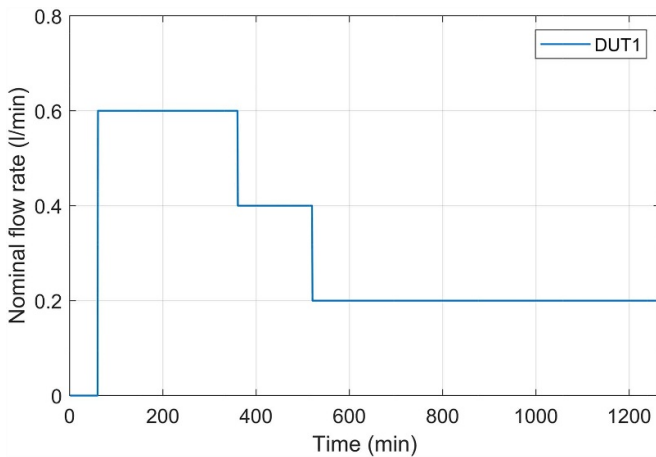

Figure 5. Nominal flow rate set during the exposure of DUT1 sensor and screen under rainfall conditions.

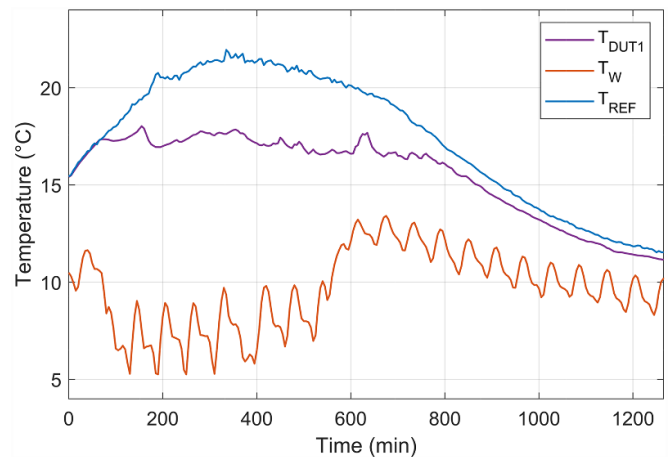

Figure 6. 5 min average measurements related to DUT1 sensor and screen under rainfall conditions: T_{REF} is the air temperature measured by the reference system (blue line), T_W is the temperature of water measured by the PT500 (orange line) and T_{DUT1} is the temperature read by the DUT1 (purple line).

and air temperature is approximately -13 K in the first part of the test and then decreased to about -3 K after having changed the flow rate to 0.2 l min $^{-1}$.

A 5 min average is used to analyze the data (for both DUTs) in order to filter out not-significant variations of the sensors' behavior due to fast transients of the air temperature or due to not perfect stability of the generator. The 5 min averages of the air temperature by the reference system (T_{REF}), the water temperature (T_W) and the air temperature measured by the DUT1 (T_{DUT1}) are shown in figure 6. A difference is apparent between DUT1 and the reference system, which decreases in the last part of the curve when the flow rate and the difference $T_W - T_{REF}$ is decreased.

To make an estimate of the error $T_{DUT1} - T_{REF}$ for different rain intensities, the same data are plotted, now considering differences in figure 7. There are two vertical scales, one

for the DUT1 error and the other for the difference between water and air temperature. The vertical dashed black lines refer to the instants when the flow rate changes (nominal values are those shown in figure 5). At the beginning the error is approximately zero since the DUT1 is outside the experimental area to verify if it is aligned with the reference system (as seen in figure 6). The initial decrease, after having turned on the generator, is probably caused by dew deposited on the sensor. Likely, sprays generated by the impact of water with the ground produced dew deposition on the screen and on the sensor. The evaporation of water droplets from the screen decreases the temperature of the microclimate inside the screen, while the evaporation from the sensor could directly decrease its temperature. This situation could be similar

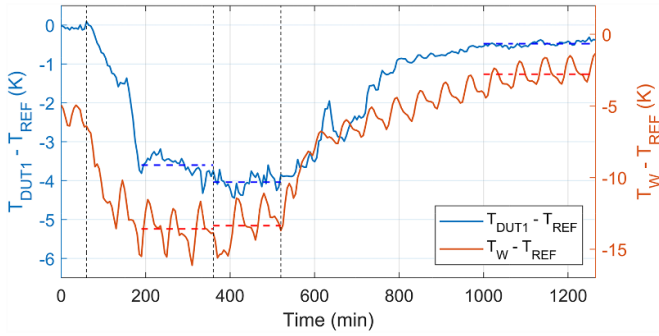

Figure 7. 5 min average temperature differences. The blue curve is the DUT1 error, $T_{DUT1} - T_{REF}$, whereas the orange curve is $T_W - T_{REF}$, that is the difference between water and air temperature measured by the reference system. The estimated measurement error and rain-air temperature difference are displayed by horizontal dashed lines (in blue and orange respectively), whereas the vertical dashed black lines refer to the instants when the flow rate changes (nominal values are those shown in figure 6).

to what happens in nature in the first instances of rainfall or when the rain intensity is very low. This phenomenon does not affect the reference system thanks to the continuous flow of air. On the other hand, air can stay inside naturally ventilated shields for longer times when wind is low, allowing heat transfer between air and shield, with a consequent decrease of air temperature. The device is then placed in the rain, at about minute 150, which produces a significant cooling of DUT1. When the water-air temperature difference was around -13 K, the error became approximately constant at about -4 K, even for a smaller flow rate equal to 0.4 l min^{-1} . In the last part of the test, the flow rate is decreased to 0.2 l min^{-1} and the water-air temperature difference is set to approximately -3 K (as mentioned above), which is reached around 7 h later. This slow behavior is explained by the fact that the intensity of the heat transfer from the air to the sensor and shield is very low in the nearly still standing air and that the air temperature (not controlled) is decreasing during that part of the experiment, thus requiring more time to reach an almost constant difference. During this time interval the rain intensity remained constant, therefore the (absolute) decrease observed by the measurement error from -4 K to about -0.5 K can be brought back to the decrease (in magnitude) of the difference $T_W - T_{REF}$. Table 1 reports the estimated values for $T_{DUT1} - T_{REF}$ and $T_W - T_{REF}$ for different part of the experiment (corresponding to different set flow rate). The uncertainty for the average values is calculated considering the instrumental uncertainty of the thermometers and the dispersion of the signal in the time interval of interest.

The same experiment is reproduced for DUT2. Similarly to DUT1, figure 8 reports the flow rate set during the execution of the experiment, figure 9 shows the 5 min averages of T_{REF} , T_W and T_{DUT} , whereas figure 10 displays the 5 min average differences. Even though the water-air temperature difference is set as for DUT1 experiment, the estimated averages $T_W - T_{REF}$, are not exactly the same since the (outdoor) air temperature is not controlled and due to the instability of the cooling system. However, the performances of the two devices

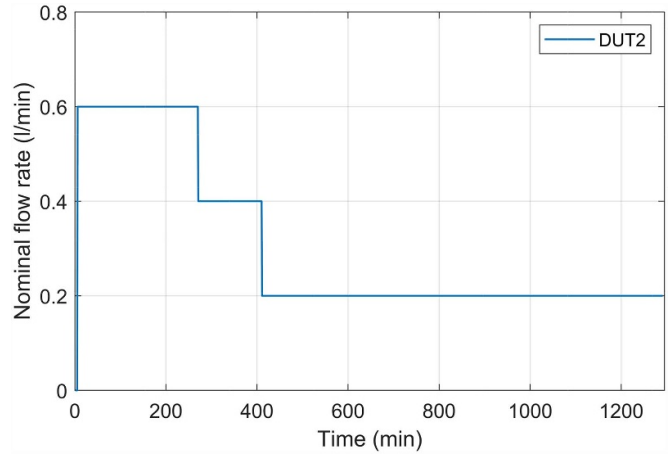

Figure 8. Nominal flow rate set during the exposure of DUT2 sensor and screen under rainfall conditions.

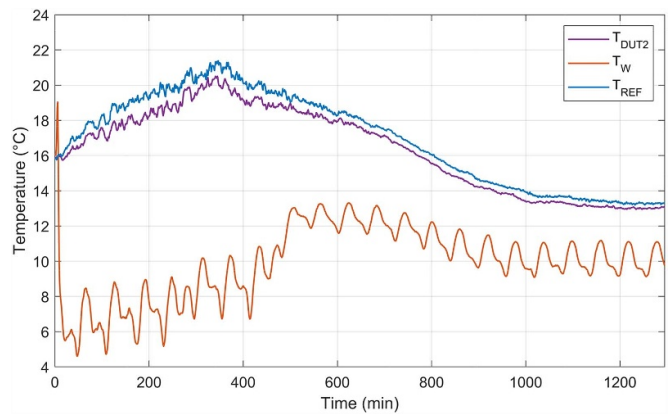

Figure 9. 5 min average measurements related to DUT2 sensor and screen under rainfall conditions: T_{REF} is the air temperature measured by the reference system (blue line), T_W is the temperature of water measured by the PT500 (orange line) and T_{DUT2} is the temperature read by the DUT1 (purple line).

under test can be considered approximately comparable since the $T_W - T_{REF}$ differences are comparable within their standard uncertainty. Indeed, the overall behavior of DUT2 is similar to DUT1, but the measurement error is lower thanks to the artificial ventilation. Indeed for 0.6 l min^{-1} as rainfall intensity the average DUT2 error is -1.1 (0.2) K instead of -3.6 (0.3) K for DUT1. A decrease of the flowrate to 0.4 l min^{-1} does not produce a significant variation in the error. Finally, in the last part of the experiment, for 0.2 l min^{-1} and decreasing the water-air temperature difference (in magnitude), the DUT2 error decreases to a value comparable to that of DUT1. Estimations of the measurement error with associated standard uncertainty are again reported in table 1.

4. Discussion

The performed tests show that the thermometer in a naturally ventilated screen is highly affected by rainfall. The maximum

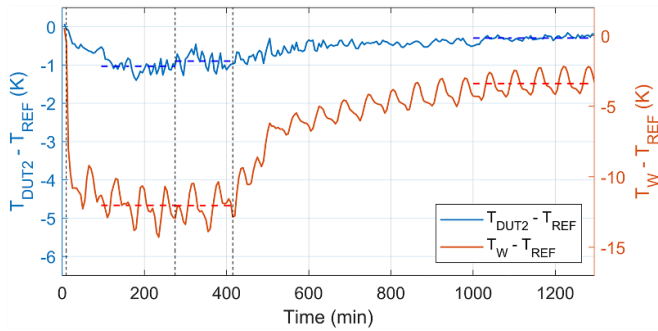

Figure 10. 5 min average temperature differences. The blue curve is the DUT2 error, $T_{\text{DUT2}} - T_{\text{REF}}$, whereas the orange curve is $T_{\text{W}} - T_{\text{REF}}$, that is the difference between water and air temperature measured by the reference system. The estimated measurement error and rain-air temperature difference are displayed by horizontal dashed lines (in blue and orange respectively), whereas the vertical dashed black lines refer to the instants when the flow rate changes (nominal values are those shown in figure 9).

quantified error is equal to -4.0 K with an expanded uncertainty of 0.4 K ($k = 2$), corresponding to a rainfall intensity of 15 mm h^{-1} (0.4 l min^{-1}) and an average difference $T_{\text{W}} - T_{\text{REF}}$ equal to -13.4 K with expanded uncertainty of 2.8 K ($k = 2$). Naturally ventilated screens should allow a good coupling between the thermometer and the air through paths with the external environment (multiple parallel paths for multi-plates screens or spiral path as for DUT1). In slowly moving or still air, as is the case in this experiment, the convective heat-flux from the outside air to the sensor is low. The walls of the screen are cooled by the rain, which reduces the air temperature inside the screen. The measurement chamber and the thermometer may also be wettened through splashes and dew deposition adding to the effect. This result shall be considered as a worst-case scenario since in most real-life situations the difference between rain and air temperature can be smaller than what is simulated here. The presence of wind would result in improved heat-transfer to the sensor reducing the measurement error but enhances evaporative cooling of the screen making the error larger. However, the wind will also shorten the recovery time needed to measure again the correct temperature after rainfall.

Overall, the artificially ventilated thermometer performs better than the naturally ventilated one under rainfall conditions as simulated in the experiments. The maximum quantified error is equal to -1.1 K with an expanded uncertainty of 0.4 K ($k = 2$), corresponding to a rain rate of 20 mm h^{-1} (0.6 l min^{-1}) and an average difference $T_{\text{W}} - T_{\text{REF}}$ equal to -12.1 K with expanded uncertainty of 2.2 K ($k = 2$). The difference in performance of DUT1 and DUT2 are as expected as the heat-transfer from the air to the sensor is improved as discussed above for DUT2. As for DUT1, the walls of the screen are cooled by the rain. The measurement chamber and the thermometer may also be wettened, but the continuous air flow inside the artificially ventilated screen would speed up evaporation of deposited water. Furthermore, the thermometer inside DUT2 is continuously in contact with fresh air, which stays in

the screen for a very short time and is not cooled significantly by heat-transfer to the screen walls. An error remains, even though small, when the difference $T_{\text{W}} - T_{\text{REF}}$ and the rainfall intensity is decreased, which is comparable to the results obtained with naturally ventilated DUT1. This implies that also in mild rainfall conditions the thermometers could measure something not representative of the air temperature. As for DUT1, these results could be seen as a worst-case scenario, but they allow to say that the tested artificially ventilated thermometer is much less affected by rainfall than the naturally ventilated one.

Since the error in real use is both dependent on the temperature difference between air and water, the rain intensity (in a lesser degree), and the wind speed, it is very difficult to apply a practical correction based on performed laboratory experiments. However, these tests give a first quantitative indication of the behavior of thermometers under rainfall conditions, highlighting the importance of the difference between rain and air temperature and how carefully air temperature measurements, under this condition, should be analyzed. To get more accurate data for quantifying the effect on different types of screens, more experiments need to be done under realistic conditions. For this purpose, a new improved rain-generator allowing better control of the water temperature and of the intensity and uniformity of the rain has been designed in the EMPIR project ‘19SIP03—Climate reference station’ and is planned to use it in future experiments.

5. Conclusions and recommendations

A rainfall generator and a reference system, used to measure air temperature, have been designed and constructed to investigate the effect of rain temperature and rain intensity on shielded air thermometers. Several tests have been performed to establish the effect of rain on two different types of radiation screens. The tests show that, especially for naturally ventilated thermometers, the errors due to rainfall can be unacceptably large and the time before the thermometer is in thermal equilibrium with the air after a rainfall may be very long. For the artificially ventilated air thermometers the errors observed are less significant.

The error and time constant depend on the difference between the rain and air temperature and in a lesser degree on the rain intensity. The influence of wind speed has not been investigated in this study but will play a significant role. The presence of wind can induce an over-cooling of the thermometer after rainfall and at the same time speeding up the recovery time and improving the heat-transfer from the air to the sensor in the case of naturally ventilated screens. Applying a correction for the error, based on the reported experiments, is therefore not practical. However, this preliminary study gives a quantitative indication of the behavior of thermometers under rainfall conditions, highlighting the importance to further investigate this problem. The reported methodology can help to develop future standardized test protocol to qualify the device with regards to the measurement error as a function of

the rain and to the speed it recovers after rainfall. To develop a standardized test, the following minimum requirements should be specified:

- Requirements of a suitable rain generator: uniformity of rainfall and surface area covered.
- Use of a suitable reference measurement system for measuring air temperature
- Distance between rain generator and device under test.
- Rain intensity given as a realistic range.
- Difference between air and rain temperature and stability.
- Time from the switch on to the switch off of the generator.
- Maximum wind speed allowed.

Eventually, having defined in the future a standardized test protocol, a large scale intercomparison between many screens of different manufacturers would be performed to assess the best characteristics of a screen for reducing the bias in air temperature measurement during and immediately after rainfall.

Data availability statement

The data that support the findings of this study are openly available at the following URL/DOI: <https://doi.org/10.5281/zenodo.13135140>.

Acknowledgment

This work is being developed within the framework of the MeteoMet2 project, which has received funding from the EMRP program co-financed by the Participating States and from the European Union.

Author contribution

JN: Conceptualization, Methodology, Formal analysis, Writing—review & editing.

PO: Conceptualization, Methodology, Investigation, Formal analysis, Writing—review & editing.

TN: Conceptualization, Methodology, Investigation.

MKN: Conceptualization.

AB: Formal analysis, Validation, Visualization, Writing—original draft preparation.

AM: Writing—review & editing.

CM: Formal analysis, Writing—review & editing.

GC: Writing—review & editing.

Conflict of interest

The authors declare that they have no conflict of interest.

ORCID iDs

Alberto Bottacin  <https://orcid.org/0000-0003-3284-6310>

Chiara Musacchio  <https://orcid.org/0000-0001-7473-3678>

Graziano Coppa  <https://orcid.org/0000-0002-2847-3286>

Andrea Merlone  <https://orcid.org/0000-0002-3651-4586>

References

- Baker H D, Ryder E A and Baker N H 1961 *Temperature Measurement in Engineering* vol II (Wiley) ch 10.12–10.15
- Bosma R and Peruzzi A 2014 climatic chamber for temperatures up to 180 °C and pressures up to 0.5 MPa *Int. J. Thermophys.* **35** 738–47
- Brandsma T and van der Meulen J P 2008 Thermometer screen intercomparison in De Bilt (The Netherlands), Part II: description and modelling of mean temperature differences and extremes *Int. J. Climatol.* **28** 389–400
- Byers H R, Moses H and Harney P J 1949 Measurement of rain temperature *J. Meteor.* **6** 51–55
- Consultative Committee on Thermometry (CCT): 2014 Guide on secondary thermometry, Thermistor Thermometry (available at: www.bipm.org/utis/./Guide-SecTh-Thermistor-Thermometry.pdf)
- Heinonen M et al 2013 *EURAMET P1061* Comparison of air temperature calibrations, final report (available at: www.euramet.org/Media/docs/projects/EURAMET-P1061_THERM_Final_Report_v4_MH111113.pdf)
- ISO 17714 2007 Meteorology—air temperature measurements—test methods for comparing the performance of thermometer shields/screens and defining important characteristics
- ISO 7726 2001 Ergonomics of the thermal environment—Instruments for measuring physical quantities
- Lin X, Hubbard K G, Walter-Shea E A, Brandle J R and Meyer G E 2001 Some perspectives on recent *in situ* air temperature observations: modeling the microclimate inside the radiation shields *J. Atmos. Ocean Tech.* **18** 1471–84
- MeteoMet project (EURAMET JRP-contract number ENV07) 2015 metrology for pressure, temperature, humidity and airspeed in the atmosphere, final publishable JRP report (available at: www.euramet.org/download?tx_eurametfiles_download%5Baction%5D=download&tx_eurametfiles_download%5Bcontroller%5D=File&tx_eurametfiles_download%5Bfiles%5D=28486&tx_eurametfiles_download%5Bidentifier%5D=%252Fdocs%252FEMRP%252FJRP%252F2010%252FENV07_Final_Publishable_JRP_Report.pdf&cHash=ba1aff561e1d401a432b83c379ef28dc)
- Michalski L, Eckersdorf K, Kucharski J and McGhee J 2001 *Temperature Measurement* (Wiley) ch 12.1.2.
- Nielsen J and Barendregt C 2004 The use of thermistors for establishing the temperature conditions in a climatic chamber *Proc. of TEMPMEKO2004* 781–6
- Nielsen J, Østergaard P, Nielsen T and Rasmussen M K 2024 Evaluation of the influence of rain on air surface temperature measurements [Dataset] *Zenodo* <https://doi.org/10.5281/zenodo.13135140>
- Tegeler E 2004 Radiation effects and its consequences on measurements in climatic chambers *Proc. of TEMPMEKO2004* 795–800
- van der Meulen J P and Brandsma T 2008 Thermometer screen intercomparison in De Bilt (The Netherlands), Part I: understanding the weather-dependent temperature differences *Int. J. Climatol.* **28** 371–87
- van Geel J L W A, Bosma R, van Wensveen J and Peruzzi A 2015 Thermistors used in a climatic chamber at high temperature and humidity *Int. J. Thermophys.* **36** 569–73
- World Meteorological Organization (WMO) 2018 *Guide N.8 On Instruments and Methods of Observation*