

Sustainable Urban Mobility

*Original*

Sustainable Urban Mobility / Dalla Chiara, B.. - STAMPA. - (2023), pp. 1-17. (Intervento presentato al convegno International conference on advances in traffic and communication technologies (ATCT) tenutosi a Sarajevo (BiH) nel 11-12.05.2023) [10.59478/ATCT.2023].

*Availability:*

This version is available at: 11583/2996163 since: 2025-01-03T09:08:54Z

*Publisher:*

University of Sarajevo, Faculty of Traffic and Communications

*Published*

DOI:10.59478/ATCT.2023

*Terms of use:*

This article is made available under terms and conditions as specified in the corresponding bibliographic description in the repository

*Publisher copyright*

(Article begins on next page)

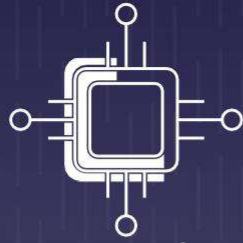

ATCT<sup>20</sup><sub>23</sub>

SECOND INTERNATIONAL CONFERENCE ON ADVANCES IN  
TRAFFIC AND COMMUNICATION TECHNOLOGIES

11th - 12th May 2023, Sarajevo, Bosnia and Herzegovina

# CONFERENCE PROCEEDINGS

*"Sustainable urban mobility"*

Organized by:

University of Sarajevo, Faculty of Traffic and  
Communications Institute of Traffic and Communications

Supported by:

Ministry of Communications and Transport of Bosnia and Herzegovina

# Conference Proceedings

SECOND INTERNATIONAL CONFERENCE ON ADVANCES IN TRAFFIC AND  
COMMUNICATION TECHNOLOGIES

---

*“Sustainable urban mobility”*

May 11<sup>th</sup> - 12<sup>th</sup> 2023

Sarajevo, 2023

# ATCT 2023

Conference Proceedings of Second International Conference on Advances in Traffic and Communication Technologies  
(ATCT) – “Sustainable urban mobility”

<b>For publisher</b>	Prof. dr. Amel Kosovac
<b>Proceedings editors</b>	Prof. dr. Amel Kosovac Doc. dr. Alem Čolaković Doc. dr. Belma Memić Doc. dr. Ermin Muharemović Doc. dr. Muhamed Begović Doc. dr. Elma Avdagić Golub Mr. Aida Kalem Mr. Edvin Šimić
<b>Publisher</b>	University of Sarajevo, Faculty of Traffic and Communications Zmaja od Bosne 8 71000 Sarajevo Phone: (+387 33) 56 52 00 Fax: (+387 33) 22 59 85 Email: info@fsk.unsa.ba
<b>Year</b>	May, 2023

ISBN 978-9958-619-54-0

CIP record available in the COBISS system of the National and University Library of Bosnia and Herzegovina  
under ID number 56820998

# ATCT 2023

---

**ORGANIZED BY:**

University of Sarajevo - Faculty of Traffic and Communications

Institute of Traffic and Communications, Sarajevo

---

**SUPPORTED BY:**

Ministry of Communications and Transport of Bosnia and Herzegovina

---

**SPONSORED BY:**

---

**INTERNATIONAL  
ACADEMIC SCIENTIFIC  
COMMITTEE/PRESIDENT**

**Prof.dr. Amel Kosovac**

University of Sarajevo, Faculty of Traffic and Communications

---

**Prof. dr. Amel Kosovac** /University of Sarajevo, Faculty of Traffic and Communications/ B&H  
**Prof. dr. Samir Čaušević** /University of Sarajevo, Faculty of Traffic and Communications/ B&H  
**Prof. dr. Fadila Kiso** /University of Sarajevo, Faculty of Traffic and Communications/ B&H  
**Prof. dr. Osman Lindov** /University of Sarajevo, Faculty of Traffic and Communications/ B&H  
**Prof. dr. Suada Dacić** /University of Sarajevo, Faculty of Traffic and Communications/ B&H  
**Prof. dr. Mustafa Mehanović** /University of Sarajevo, Faculty of Traffic and Communications/ B&H  
**Prof. dr. Drago Ezgeta** /University of Sarajevo, Faculty of Traffic and Communications/ B&H  
**Prof. dr. Azra Ferizović** /University of Sarajevo, Faculty of Traffic and Communications/ B&H  
**Prof.dr. Nedžad Branković** /University of Sarajevo, Faculty of Traffic and Communications/ B&H  
**Prof. dr. Muharem Šabić** /University of Sarajevo, Faculty of Traffic and Communications/ B&H  
**Prof. dr. Nino Ćorić** /University of Sarajevo, Faculty of Traffic and Communications/ B&H  
**Prof. dr. Ahmed Ahmić** /University of Sarajevo, Faculty of Traffic and Communications/ B&H

---

**INTERNATIONAL  
ACADEMIC SCIENTIFIC  
COMMITTEE/MEMBERS**

**Prof. dr. Zvonko Kavran** /University of Zagreb, Faculty of Transport and Traffic Sciences/ Croatia  
**Prof. dr. Mladenka Blagojević** /University of Belgrade, Faculty of Transport and Traffic Engineering / Serbia  
**Prof. dr. Mimo Drašković** /University of Montenegro, Faculty of Maritime Studies Kotor/ Montenegro  
**Prof. dr. Dragana Šarac** /University of Novi Sad , Faculty of Technical Sciences/ Serbia  
**Prof. dr. Zoran Ćurguz** /University of East Sarajevo, Faculty of Transport and Traffic Engineering Doboju/ B&H  
**Prof. dr. Elen Twrdy** /University of Ljubljana, Faculty of Maritime Studies and Transport/ Slovenia  
**Prof. dr. Nikola Trubint** /University of Novi Sad , Faculty of Technical Sciences/ Serbia  
**Prof. dr. Pero Škorput** /University of Zagreb, Faculty of Transport and Traffic Sciences/ Croatia  
**Prof. dr. Marina Zanne** /University of Ljubljana, Faculty of Maritime Studies and Transport/ Slovenia  
**Prof. dr. Isak Karabegović** /University of Bihac , Faculty of Technical Engineering/ B&H  
**Prof. dr. Nebojša Arsić** /University of Pristina, Kosovska Mitrovica  
**Prof. dr. Srđan Jović** /University of Pristina Faculty of Technical Sciences, Kosovska Mitrovica  
**Prof. dr. Vuk Bogdanović** /University of Novi Sad , Faculty of Technical Sciences/ Serbia  
**Prof. dr. Snežana Tadić** /University of Belgrade, Faculty of Transport and Traffic Engineering/ Serbia  
**Prof. dr. Slobodan Zečević** /University of Belgrade, Faculty of Transport and Traffic Engineering/ Serbia  
**Doc. dr. Nikola Trubint** /University of Novi Sad , Faculty of Technical Sciences/ Serbia  
**Prof. dr. Srđa Popović** /Faculty of transport, communications and logistics Budva/ Montenegro  
**Prof. dr. Špiro Ivošević** /University of Montenegro, Pomorski fakultet Kotor/ Montenegro  
**Prof. dr. Nebojša Bojović** /University of Belgrade, Faculty of Transport and Traffic Engineering/ Serbia  
**Prof. dr. Marko Šoštarić** /University of Zagreb, Faculty of Transport and Traffic Science / Croatia  
**Prof. dr. Goran Mijoski** /University „Ss. Cyril and Methodius“, Faculty of civil engineering Skopje/ North Macedonia

---

---

**Prof. dr. Marija Malenkovska Todorova** /Faculty of Technical Sciences, University St. Kliment Ohridski Bitola/ North Macedonia  
**Prof. dr. Amela Ajanović** /Technische Universitaet Wien (TUW), Institute of Energy Systems and Electrical Drives, EEG/ Austria  
**Prof. dr. Sanja Steiner** /University of Zagreb, Faculty of Transport and Traffic Sciences/ Croatia  
**Prof. dr. Olja Čokorilo** /University of Belgrade, Faculty of Transport and Traffic Engineering/ Serbia  
**Prof. dr. Drago Sever** /University of Maribor, Faculty of Civil Engineering, Transportation Engineering and Architecture/ Slovenia

---

**ORGANIZING  
COMMITTEE**

**Doc. dr. Alem Čolaković** /University of Sarajevo, Faculty of Traffic and Communications/ B&H  
**Doc. dr. Ermin Muharemović** /University of Sarajevo, Faculty of Traffic and Communications/ B&H  
**Doc. dr. Belma Memić** /University of Sarajevo, Faculty of Traffic and Communications/ B&H  
**Doc. dr. Adisa Hasković** /University of Sarajevo, Faculty of Traffic and Communications/ B&H  
**Doc. dr. Nermin Goran** /University of Sarajevo, Faculty of Traffic and Communications/ B&H  
**Doc. dr. Bakir Karahodža** /University of Sarajevo, Faculty of Traffic and Communications/ B&H  
**Doc. dr. Muhamed Begović** /University of Sarajevo, Faculty of Traffic and Communications/ B&H  
**Doc. dr. Elma Avdagić Golub** /University of Sarajevo, Faculty of Traffic and Communications/ B&H  
**Doc. dr. Adnan Omerhodžić** /University of Sarajevo, Faculty of Traffic and Communications/ B&H  
**Dr. Mirza Berković** /University of Sarajevo, Faculty of Traffic and Communications/ B&H  
**Mr. Edvin Šimić** /University of Sarajevo, Faculty of Traffic and Communications/ B&H  
**Mr. Ajdin Džananović** /University of Sarajevo, Faculty of Traffic and Communications/ B&H  
**Mr. Aida Kalem** /University of Sarajevo, Faculty of Traffic and Communications/ B&H  
**Mr. Adisa Medić** /University of Sarajevo, Faculty of Traffic and Communication / B&H  
**Prof. dr. Gordana Jotanović** /University of East Sarajevo, Faculty of Transport and Traffic Engineering Doboj/B&H  
**Doc. dr. Katarina Mostarac** /University of Zagreb, Faculty of Transport and Traffic Sciences/ Croatia  
**Dr. sc. Estera Rakić** /HP – Croatia pošta d.d. Zagreb/Croatia  
**Mr. Sci. Sedin Kahrman** /BH Telecom d.d. Sarajevo/ B&H  
**Mr. Sci. Mirsad Mujić** /JP BH POŠTA d.o.o. Sarajevo/ B&H  
**Mr. Adnan Tatarević** /Institute of Traffic and Communications, Sarajevo (ISIK)/ B&H

---

## FOREWORD

Dear readers,

We are delighted to present to you the proceedings of the Second International Conference on Advances in Traffic and Communication Technologies (ATCT) – “Sustainable urban mobility” organized by the Faculty of Transport and Communications and the Institute of Traffic and Communications Sarajevo in cooperation with the Bosnia and Herzegovina Ministry of Communications and Transport. This conference brought together experts, researchers, and practitioners from various fields to discuss the latest developments, challenges, and solutions related to sustainable urban mobility. The conference featured keynote speeches, panel discussions, and paper presentations that covered a wide range of topics, including sustainable transport policies, emerging technologies, innovative mobility solutions, and urban planning and design. Our distinguished speakers included Keisuke Tanaka from the Japan International Cooperation Agency (JICA), Amela Ajanović from the Technical University of Vienna, Mila Knežević from the Deutsche Gesellschaft für Internationale Zusammenarbeit (GIZ), and Bruno Dalla Chiara from Politecnico University of Turin.

Panel session "Challenges and opportunities of sustainable urban mobility in the countries of the region" featured distinguished experts in the field, including Radoje Vujadinović, Dean of the Faculty of Mechanical Engineering at the University of Montenegro in Podgorica, Snežana Tadić from the Faculty of Transport and Traffic Engineering at the University of Belgrade, Osman Lindov from the Faculty of Traffic and Communications at the University of Sarajevo, and Estera Rakić from Training Solutions & Consulting in Croatia. Their valuable insights and perspectives shed light on the current state of sustainable urban mobility in the region and the challenges that need to be addressed to achieve a more sustainable and efficient transport system. The papers included in this volume represent a selection of the high-quality contributions presented at the conference. The papers cover various themes and perspectives, providing valuable insights and knowledge on sustainable urban mobility. We would like to express our gratitude to all the authors who have contributed to this volume and to the reviewers who provided their valuable feedback and suggestions.

We hope that this volume will serve as a valuable resource for researchers, practitioners, and policymakers interested in sustainable urban mobility. We also hope that the conference and this volume will inspire new ideas and collaborations that can contribute to a more sustainable and livable urban environment. Finally, we would like to thank all the participants, organizers, and sponsors who have made this conference a success. We look forward to future collaborations and events that promote sustainable urban mobility.

Sincerely,

Prof. dr. Amel Kosovac

Dean of Faculty of Traffic and Communications,  
University of Sarajevo

## TABLE OF CONTENTS

TITLE	PAGES
<b>UAV IN SMART CITIES – INTEGRATION IN THE AVIATION SYSTEM AND SOLUTIONS FOR SAFE OPERATIONS</b> Lidija Tomić, Anja Stamenić, Sanja Steiner, Olja Čokorilo	1-9
<b>THE DEVELOPMENT OF MOBILITY IN URBAN AREAS - EXAMPLES OF GOOD PRACTICES</b> Milena Ninović, Slaviša Dumnić, Đorđije Dupljanin	10-17
<b>MOBILE ALTERNATIVE DELIVERY POINTS</b> Šarac Dragana, Čačić Nataša, Jovanović Bojan	18-25
<b>SMARTY CITY WITH GREEN LAST MAIL DELIVERY</b> Estera Rakić, Ivana Buzdovan, Zoran Nedić	26-33
<b>THE SUSTAINABILITY OF URBAN POSTAL LOGISTICS AND THE AR TECHNOLOGY</b> Slavica Radosavljević, Biljana Grgurović, Jelena Milutinović, Stevan Veličković	34-38
<b>TRAM-TRAIN SYSTEM APPROVAL PROCEDURE</b> Nermin Čabrić, Nedžad Branković, Aida Kalem	39-46
<b>CONTRIBUTION TO THE DEVELOPMENT OF URBAN MOBILITY IN THE CITY OF SARAJEVO BY IMPLEMENTATION OF SMART MOBILITY HUBS</b> Mirzet Sarajlić, Drago Ezgeta, Adnan Omerhodžić, Nedim Kamenjašević	47-52
<b>STUDY OF BARRIERS FOR THE USE OF DRONES IN THE LIST MILE LOGISTICS</b> Snežana Tadić, Ljubica Radovanović, Mladen Krstić, Miloš Veljović	53-62
<b>CLOUD COMPUTING SYSTEM FOR EVALUATING COURIER DRIVING CAPABILITIES IN EXPRESS COURIER SERVICES</b> Gordana Jotanovic, Goran Jausevac, Dragan Perakovic, Miroslav Kostadinovic, Branko Jotanovic	63-68
<b>IMPACT OF MICRO MOBILITY ON CURB MANAGEMENT AND CITY LOGISTIC SUSTAINABILITY</b> Stevan Veličković, Biljana Grgurović, Jelena Milutinović, Slavica Radosavljević	69-75
<b>THE ROLE OF CROWD-SHIPING IN SUSTAINABLE CITY LOGISTICS</b> Jelena Milutinović, Stevan Veličković, Biljana Grgurović, Slavica Radosavljević	76-84
<b>SUSTAINABLE URBAN MOBILITY STRATEGIES OF THE EU AND WB COUNTRIES</b> Valentina Ivanović, Arnela Mujić, Edin Gadžo, Osman Lindov	85-93
<b>MULTIMODAL APPROACH IN THE ANALYSIS OF URBAN MOBILITY</b> Fadila Kiso, Samira Karičić	94-102
<b>QUALITY OF EXPERIENCE OF FUTURE ICT-BASED LOGISTICS AND TRANSPORT SYSTEMS</b> Sabina Baraković, Jasmina Baraković Husić	103-108



<b>THE ROLE OF SMART SENSORS IMPLEMENTED IN VEHICLES FOR TRAFFIC AUTOMATION OF THE FUTURE</b>	109-116
Isak Karabegović, Mehmed Mahmić, Edina Karabegović, Ermin Husak	
<b>PCA MODELING OF EXTRACTION AND SELECTION OF VARIABLES INFLUENCING LTE NETWORK DELAY IN URBAN MOBILITY CONDITIONS</b>	117-125
Mirko Stojčić, Milorad K. Banjanin, Milan Vasiljević, Aleksandar Stjepanović, Zoran Ćurguz	
<b>DATA ARCHITECTURE PROPOSAL OF BIG DATA PLATFORM FOR SMART WASTE MANAGEMENT SOLUTION</b>	126-130
Sanid Muhić, Nermin Goran	
<b>MACHINE LEARNING MODELING FOR REDUCING GREENHOUSE GAS EMISSIONS IN URBAN AREAS</b>	131-136
Amel Kosovac, Adisa Medić, Muhamed Begović	
<b>CREATE SUSTAINABLE AND SMART MOBILITY IN THE WESTERN BALKANS COUNTRY</b>	137-142
Samir Džaferović, Mirza Berković, Adnan Omerhodžić	

# UAV in smart cities – integration in the aviation system and solutions for safe operations

Lidija Tomić<sup>1</sup>, Anja Stamenić<sup>2</sup>, Sanja Steiner<sup>3</sup>, Olja Čokorilo<sup>4</sup>

<sup>1</sup>College of Applied Studies Aviation Academy, Bulevar Vojvode Bojovića 2, 11000 Belgrade, Serbia

<sup>2</sup>Aviation Academy, Bulevar Vojvode Bojovića 2, 11000 Belgrade, Serbia

<sup>3</sup>University of Zagreb, Faculty of Transport and Traffic Sciences, Vukelićeva 4, 10000 Zagreb, Croatia

<sup>4</sup>University of Belgrade, Faculty of Transport and Traffic Engineering, Vojvode Stepe 305, 11000 Belgrade, Serbia

## Abstract

UAVs have a wide range of applications that can contribute greatly to the development of smart cities, as their usage can be cost-effective, available on demand, and environmentally-friendly. However, several challenges and issues such as safety, privacy, and security arise. Mentioned opportunities and challenges are identified in the paper by performing a backcasting approach method. To achieve UAV benefits, appropriate solutions for UAV's safe integration into the aviation system are needed. The main paper's objective is to provide, based on an analysis of UAV's possible applications and requirements from aviation system, as well as outputs from backcasting analysis, suggestions of possible solutions for UAV's safe operations. It is concluded that it is needed to develop and implement solutions that cover operational, technical, and safety requirements. Solutions regarding needed infrastructure (airspace zones and routes, droneports, etc.), UAV management systems in smart cities, UAV technical capabilities for collision detection and avoidance, and safety risk management approaches are recognized as crucial to enabling UAV safe integration into smart cities.

**Keywords:** UAV, Aviation, Smart Cities, Safety, Backcasting Approach Method

## 1 Introduction

The Smart Cities of the future will be developing as a result of the merging of many new-generation technologies and solutions. Regarding smart city design, the main goal is to provide efficient and environmentally-friendly infrastructures and services at reduced costs [1]. UAVs (Unmanned Aerial Vehicles) are recognized as an important solution with many opportunities that will be very beneficial for the population, and contribute to the economic growth and development of smart cities. However, several challenges and issues such as safety, privacy, and security arise. Moreover, as UAV's operational environment is airspace, the

main concern is related to the safety of other airspace users – manned aviation.

The UAVs can have a relatively minor impact on conventional aviation as long as manned and unmanned aircraft were operated in a segregated manner. However, as both industries are moving closer to each other, with an expanding operational interface and an increasing number of overlaps, it is intuitively clear that mentioned impact can be changed within the coming years [2].

To achieve UAV benefits in smart cities, appropriate solutions for UAV's safe integration into the aviation system are needed.

---

Corresponding author: Lidija Tomić (lidijatomic11@gmail.com)

© 2023 The Author(s). This work is licensed under a Creative Commons Attribution 4.0 International License.

Aviation regulatory agencies take great efforts to create needed regulations to ensure a safe environment. Thus, the European Union Aviation Safety Agency EASA publication [3] contains the rules and procedures for the operation of unmanned aircraft based on adopted EU regulations. However, it should be kept in mind that the regulatory framework that will cover certain areas of application or potential concerns related to UAV integration in the aviation system, such as the usage of UAVs in smart cities, is still under development. It is intuitively clear that regulation development is connected with the development of appropriate solutions by the aviation community.

Several research works [4], [5], [6], [7] proposed different solutions that will contribute to the UAV safe integration in smart cities from different perspectives, mainly related to Air Traffic Control (ATC) systems features.

This paper aims to identify mentioned solutions as strategies that should be applied in the coming years, considering different levels of UAV integration in smart cities in the next 15 years. Proposed strategies will contain technological and policy solutions for safe operations.

Placing technological and policy improvement, in relation to the level of UAV autonomy and different intended applications, for the safe integration of UAS (Unmanned Aircraft System- presenting UAV with involved personnel and systems) in common airspace with manned aviation, requires the creation of adequate steps or scenarios on the trajectory to desired future. For this research, three different scenarios, covering the look of smart cities in the next 15 years (5+, 10+, 15+ years), will be created.

## **2 UAVs in smart cities**

### **2.1 Opportunities**

UAVs, originally developed and used for military purposes, have found applications in many civil sectors during the last decade.

As cost-effective, available on-demand, and environmentally-friendly solutions, UAVs have a wide range of applications that can contribute greatly to the development of smart cities [8].

Namely, the main strengths of UAV usage in urban areas include shorter operations distance

(which enables faster operations, and consequently less greenhouse gas emissions), extended connectivity, and real-time information, but also flexibility, mobility, and accessibility to remote areas which enable ad-hoc operations with a great level of precision, and reduced response time [8].

In addition, UAVs can be equipped with various sensors and cameras for doing intelligence, surveillance, and reconnaissance missions. Furthermore, when equipped with appropriate equipment UAVs can be used for specific missions such as firefighting, de-icing/anti-icing of infrastructure, gardening support, etc.

Authors in their research [1], [8] list possible UAV applications in urban areas. Applications such as Geo-spatial and Surveying activities, Civil Security Control, Traffic and Crowd Management, Natural Disaster Control and Monitoring, Environmental Management, Wireless Communications, Commercial activities (like package deliveries), and Urban Air Mobility (UAM), are some of the expected usages of UAVs in future smart cities.

### **2.2 Challenges**

Following the industry's tremendous development in recent years, the need for a system to support the safe and efficient integration and management of UAV into airspace has become essential. In Europe, main effort and plan to develop this system is called U-space and it is based on establishing U-space airspaces in which a minimum and mandatory set of services will be provided [9].

The document Concept of Operations (ConOps), developed by the CORUS-XUAM project team tries to answer the basic question "How does U-space work" and in doing so provides a common basis for discussion of details. The ConOps provides terminology and a general model of the overall system of U-space [10].

Because of the fact that aviation is the most vulnerable industry, since UAVs and aircraft share the same airspace and therefore potentially catastrophic consequences if collisions occurred, mentioned efforts start from the aviation sector.

However, as the way to a desired future will take a long path, to achieve mentioned benefits, it is also important to develop smart city

management systems and involved appropriate stakeholders. There are many questions that need to be addressed like providing adequate infrastructure, monitoring and controlling UAV operations, provision of information and assistance services to UAVs operator, emergency response plan, etc.

Accordingly, in comparison to the U-space concept, analysis within this research will be oriented also from the smart cities side, with aim of identifying strategies that needed to be developed and implemented for a safe aviation system with the presence of autonomous UAVs.

Detailed opportunities and challenges will be covered in the paper by using the backcasting approach, i.e. by imaging the future containing mentioned opportunities, and by analyzing requirements for a such look – challenges that need to be solved via different strategies.

### 3 Methodology

Backcasting is holistic approach, focusing on targets and desirable future [11]. It starts with defining a desirable future and then works backwards to identify strategies- policies and technologies that will connect that specified future to the present.

Backcasting methodology includes four steps [11]:

- I. Identification of problem and targets
- II. Definition of a baseline scenario
- III. Design of future scenarios
- IV. Analysis and assessment of technologies and policy packages (strategies) that could serve as pathways from the present to the targeted period.

Before starting with methodology steps, it is important to define system boundaries. For the purpose of this research, “full integration of UAV in the aviation system” is related to UAVs serving smart cities. Thus the use of airspace will be virtually vertically limited to the heights on which UAM operations in smart cities are expected because the heights that commercial manned aircraft use in the cruise will not be needed. This means that overlapping will be at airspace lower levels.

### 3.1 Identification of problem and targets

In this research, the target or desired future is smart cities with autonomous UAVs fully integrated into the aviation system (looking 15 and more years from now), in a way that the safety of the other airspace users (manned aviation) will not be compromised.

To achieve this and set appropriate solutions for safe operations, it is needed to consider different scenarios (in the paper it will be S1, S2, and S3) that will be expected in the following years (5+, 10+, 15+), i.e. steps on the path to desired future. The assumption is that the mentioned scenarios overlap due to unevenness in the development and integration of UAVs in different parts of Europe, and that is why the “year+” designation is used.

The problem can be formulated as: “What are solutions to create, organize and provide safe operations of autonomous UAVs in smart cities, fully integrated into the aviation system?”.

Each scenario will be described with features regarding infrastructure look (operations environment), flight authorization service, operations identification and monitoring service, other information services, involved stakeholders, interaction with manned aviation, etc.

From the mentioned features of smart cities design in three designed scenarios will be, in the backward path manner, extrapolated requirements for such look i.e. strategies (policies and technologies) that will connect the specified future to the present, as illustrated in the figure below (Figure1).

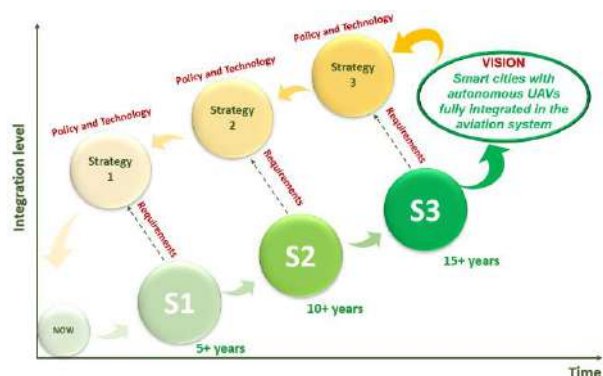

Fig. 1. Backcasting approach for UAVs in smart city

### 3.2 Definition of a baseline scenario

The baseline scenario, representing “now”, includes several assumptions but also overlapped with S1 because of the mentioned unevenness in the development of UAV innovation and integration across Europe countries. Namely, following assumptions and features exist:

- A very small number (or without) of UAVs perform tasks that serve smart cities.

- The use of UAVs is exclusively limited to segregated volumes of airspace due to the absence of appropriate protocols needed for their integration into the auspices of the Air Traffic Management (ATM) system [12].

- Before UAVs start to access civil airspace, there is a need to be systematically and functionally recognized in terms of regulations. In the baseline scenario, the regulatory framework regarding UAV classification and airworthiness standards is settled by European regulatory agencies, and UAVs need to be certified. Similarly, UAV operators should be licensed by National Civil Aviation Authority (NCAA) after completing adequate training.

- Request for authorization for operations is submitted to NCAA enough time (days) in advance. On the day of operations, the UAV operator needs to conduct a self-briefing before each operation (for example by approaching MEUH- *Meteorology, Environment, UAV and Human* check, which includes pre-defined checklists with limitations) to decide whether to start with operations or not.

- It can be said that the overall system safety management approach is mainly reactive, in terms of if an unsafe situation occurs, the UAV operator needs to report it to the NCAA which will later analyze it and propose further measures to keep the system safe. The proactive side can be connected with the effort of European regulatory agencies through the development of standards and recommended practices (SARPS) that NCAA needs to incorporate within national regulation.

- Regarding involved stakeholders, NCAA has a central role and needs to communicate with ANSP to make a decision to authorize operations or not. This means that capacity in terms of processing requests for operations is limited.

### 3.3 Design of future scenarios

The following three scenarios are developed within the research:

I. *Scenario 1*: The future smart cities with remotely-controlled unmanned aerial vehicles used for on-demand government-related and security purposes, like emergencies (medical and firefighting applications), public security (police monitoring and patrolling), and recreational purposes, and operating outside the manned civil aviation airspace. The S1 considers the next 5 (+) years from now.

II. *Scenario 2*: The future smart cities with both remotely-controlled and partly-autonomous unmanned aerial vehicles used for a wide range of commercial applications (like package delivery), not fully integrated into civil aviation airspace. The S2 considers the next 10 (+) years from now.

III. *Scenario 3*: The future smart cities with swarms of autonomous unmanned aerial vehicles for different purposes including people mobility- air taxi, fully integrated into the aviation airspace. The S3 considers the next 15 (+) years from now.

The following Figures (Figure 2, 3, and 4) illustrates mentioned scenarios and are followed by a description in terms of their main features.

#### 3.3.1 Scenario 1 (S1)

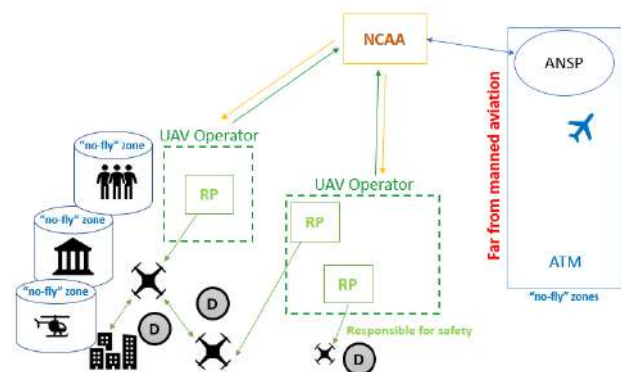

Fig. 2. Scenario 1

Within S1, all UAVs used for intended applications in smart cities (except recreational under defined criteria) need to be registered, and UAVs operators licensed, by NCAA. UAV operator request authorization for each operation from NCAA. The NCAA provides rules for flying including maps with pre-defined restrictive or “no-fly” zones, but also provides advisory services to UAV operators on request. The remote pilot (RP) is directly responsible for operations safety.

Airspace configuration includes segregated zones- for manned aviation, for UAV operations, and restricted zones. Airspace, where UAV operations are intended (uncontrolled airspace.), is far from manned aviation, and airports are presented as “no-fly” zones for UAVs. Other “no-fly” zones in smart cities include locations where a large number of people is expected (like schools) and buildings of importance (like state assembly).

The several locations created as start/ return positions for UAV operations will exist, named for this research as “droneports”.

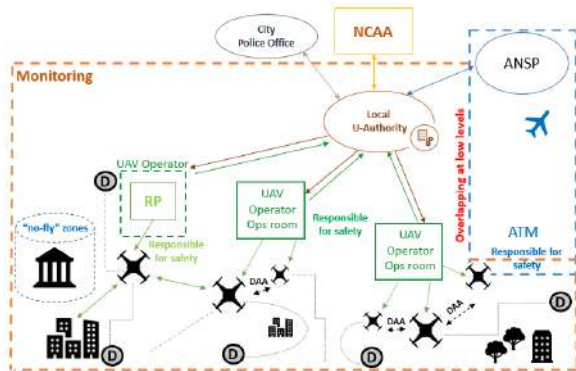

Fig. 3. Scenario 2

### 3.3.2 Scenario 2 (S2)

Within S2, there will be a specifically created organization, for example (proposed by authors), “Local U-Authority” consisting of representatives from the NCAA, Air Navigation Service Providers (ANSP), and the City Police Office, which will be responsible for monitoring and partly controlling UAV operations in smart cities.

Namely, “Local U-Authority” will have a role to incorporate interests from manned aviation, UAV operators, and local city police, with aim of maintaining the safety of all the actors (aircraft, UAV, people). The role of “Local U-Authority” will include UAV operator registration and

operations authorization, but also the provision of available routes (pre-defined routes for specific UAV applications), daily operation plans, and traffic information service, all at the tactical level.

Within the operational level, “Local U-Authority” will have a traffic monitoring role, with channels for real-time communication with UAV Operators' operations room, while the procedural interface with ANSP will also exist because the airspace overlapping with manned aviation is expected at low levels near/ at airports (for example cargo terminals at landside airport zone).

The “no-fly” zones will remain for specific locations (buildings of importance). As mentioned, within the smart city's airspace, pre-defined routes for specific UAV applications will exist. Droneports will exist in more locations than in S1. The presence of some partly-autonomous UAVs is also expected. UAV operator is directly responsible for safety but in the overlapping airspace, safety responsibility is also on the “Local U-Authority” and ANSP.

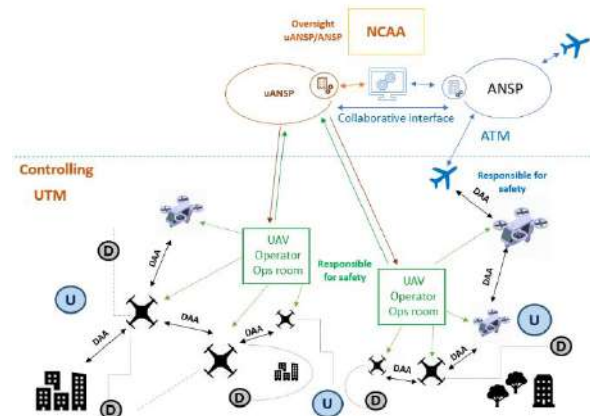

Fig. 4. Scenario 3

### 3.3.3 Scenario 3 (S3)

Within S3 there will be Air Traffic Management (ATM) and UAS Traffic Management (UTM) in one common airspace, with two responsible authorities - ANSP and, for example, “uANSP”(unmanned-ANSP), or ATC (Air Traffic Control) and “u-ATC” (unmanned-ATC), with a collaborative interface. Mentioned authorities will provide more services for UAS operators like real-time traffic information, weather information, etc.

Flight plans should be automatically processed via appropriate systems, enabling both higher

capacity and prevention of possible conflict situations.

Free routes airspace, but also, pre-defined routes and airspace corridors with points for creating new ones will exist. The droneports, and supporting objects are widely dispersed, for UAM there will be “U-ports” (like droneports but with specific supporting infrastructure such as passenger terminals). The “no-fly” zones will be replaced with airspace restrictions published in „uAUP“ (UAV Airspace Use Plan).

As mentioned, in this paper is assumed that airspace overlapping is expected at low (take-off and landing) and medium heights (approach and climb), but not at cruising heights, because to serve smart cities, high levels for UAVs is not needed (maximum are tallest city building with an added safety buffer). Mentioned heights will be for UAM as enabling the shortest travel distances, while lower levels will be for commercial and other applications serving people in smart cities.

A large number of autonomous UAVs will be present, and the level of safety will mainly depend on the effectiveness of Detect and Avoid (DAA) solutions on UAVs.

## 4 Analysis and Results

Contrary to the manned aviation sector, the UAV industry capitalizes fully on the use of technology to favor automation instead of human interaction. However, the human factor cannot be excluded, as it will exist at some level through the role of RP, ANSP/“u-ANSP”, etc.

By working backward to each defined scenario, the following policies and technologies are identified as three strategies (Strategy 1, 2 and 3) that will connect desired future to the present.

### 4.1 Strategy 1

Within Strategy 1, overlapping with the baseline scenario exists. But, to make the overall process of UAV operations efficient and safer in a considered period of time, improvements in terms of adopted technologies and policies should be incorporated.

Table 1 lists the policies and technologies proposed within Strategy 1.

The pre-defined risk assessment process, periodic knowledge refreshment for UAV operators to be familiar with the latest regulations, system of maps and rules for flying published by

NCAA as a strategic operations management approach, will contribute to moving on a proactive safety management approach.

Regarding technological standards, the need for improvement is recognized both for UAV design (return-to-home maneuvers, color, and lightening standards, etc.), but also for “no-fly” zone solutions (anti-drone systems at airports and near state buildings, etc.).

**Table 1.** Strategy 1

<b>Strategy S1</b>
Policies and Technologies
1. Segregated airspace with zones
2. Rules for flying and appropriate maps issued by NCAA
3. Pre-defined return-to-home routes for UAV
4. Technological standards regarding UAV design (for example color and lightening, etc.)
5. Anti-drone systems at specific locations (at airports, near important state buildings, etc.)
6. UAS operator/ Remote pilot licensed by NCAA
7. Training for UAV operators with periodic knowledge refreshments
8. Operations authorization by NCAA according to defined procedures
9. Pre-defined risk assessment before each operation
10. Accident and Incident reporting to NCAA

### 4.2 Strategy 2

Within Strategy 2, the focus will be on the development of the UAV management system in smart cities. The creation of the proposed “Local-U Authority” will be one of the solutions (with the role described in detail within 3.3.1).

Besides, regarding infrastructure, it is proposed to define common routes for specific UAV applications, both because of safe operations, and to enable easy monitoring by “Local U-Authority”.

DAA solutions need to be advanced in terms that are capable of maintaining a safe distance from other UAVs, buildings, and people.

With the proposed strategy, it can be said that Preventive Safety Management Approach will exist.

Table 2 lists the policies and technologies proposed within Strategy 2.

**Table 2.** Strategy 2

<b>Strategy S2</b>	
Policies and Technologies	
1.	Tactical capacity management system for smart city airspace
2.	Tactical flight planning (including adequate processing system) and Approval Concept
3.	Procedural interface with ANSP
4.	Tactical traffic information service
5.	Tactical conflict resolution system
6.	Monitoring system for initial tracking
7.	UAVs equipped with solutions that enable being visible on appropriate monitoring systems
8.	Channels for real-time communication with UAV Operators' ops room
9.	UAVs operator with the system to take control over the UAV in emergency situations
10.	Autonomous UAVs equipped with DAA solutions capable of maintaining safe distance from other UAVs, buildings, and people
11.	Contingency and Emergency Plan
12.	Real-time occurrence reporting system to "Local U-Authority"

### 4.3 Strategy 3

Table 3 lists the policies and technologies proposed within Strategy 3.

Within Strategy 3, a detailed UAV management system in smart cities will be incorporated into UTM. The main objective of the UTM must be safety, with a view of preventing collisions between UAV and manned aircraft and from one other along with preventing UAVs from colliding with buildings or obstacles and from falling on third parties on the surface.

Flight plans should be submitted to the automated flight plan processing system within "uANSP" for UAV operations and ANSP for manned aviation operations. Submitted flight plans need to be further automatically sent to a centralized processing system that checks the presence of possible conflict between intended operations of manned and unmanned aviation.

In this way, the proactive and predictive Safety Management Approach will be developed.

Regarding infrastructure, for free-route airspace, a high-level architecture with reliable and precision systems and links to support the UTM will be needed.

**Table 3.** Strategy 3

<b>Strategy S3</b>	
Policies and Technologies	
1.	Capacity management system on tactical and operational level
2.	Automated centralized flight plan processing system
3.	"uAUP"- UAV Airspace Use Plan
4.	Collaborative interface "uANSP" with ANSP
5.	Real-time traffic information service
6.	Advanced Monitoring system for tracking and controlling
7.	Conflict resolution system on the operational level
8.	Airspace violation control measures (for example drone catcher)
9.	Channels for real-time communication with UAV Operators' operations room
10.	UAVs operator with the system to take control over UAV in emergency situations
11.	Advanced DAA solutions compatible with ACAS for manned aircraft
12.	Implemented SMS - Safety Management System by all involved stakeholders
13.	Contingency and Emergency Plan
14.	Real-time occurrence reporting system

Advanced DAA solutions compatible with ACAS (Airborne Collision Avoidance System) for manned aircraft will be required.

Namely, in order to achieve the same level of separation and collision avoidance functionality as exist the case for manned aircraft, UAS should be designed in such a way that it effectively offsets the partial deprivation of situational awareness that is provided by a pilot inside the airframe. This could be done both procedurally and by increasing on-board systems functionality. Since some of the specific procedural actions cannot be performed by UAV directly, i.e. following other air traffic under ATC instruction, this is where UAV's capacity of performing autonomous actions comes into play [12].

The same applies in other instances such as loss of communication between the UAV and the Operations Control Room on the ground. In any case, UAS should have the ability to autonomous operation in secondary mode, which would clear the possibility of mid-air conflict by maneuvering different preprogrammed patterns [12].



Authors [13] research effectiveness of ACAS installation on unmanned aerial vehicles and shows that two of the three most influential factors are actually those within the Detect function. Therefore, more effort is required in the development of UAV system's elements that detect the conflict (sensors).

#### 4.4 Future efforts

Ideally vision will be aviation system that enable airspace users to fly their preferred flight trajectories, delivering passengers and goods on time to their destinations as cost-efficiently as possible [14].

The European ATM system and network will not be able to accommodate the expected traffic growth and the new challenges without embracing digitalization at an accelerated pace. Thus, the further improvement will be delivering a digital European sky.

The digital European sky is an evolution of the European airspace architecture that leverages modern digital technologies to decouple service provision from local infrastructure. At the same time, it progressively increases the levels of collaboration and automation support through a data-rich and cyber-secure connected digital ecosystem. Airspace configuration and design will be optimized and the system should serve a growing number of increasingly diverse aircraft (manned and unmanned) integrated into all environments and classes of airspace, operating safely [14].

It is expected that this work will contribute to mentioned effort from the safety strategy side.

## 5 Conclusion

It is expected that in the next 15 years, increasing numbers of aircraft (conventional and unmanned aircraft) will be taking to Europe's skies, with the need to operate in all environments and classes of airspace.

Because of the numbers and the diversity of applications involved, adequate infrastructure will be required to support the safe operation of UAVs in smart cities. Needed infrastructure will be evolving from a model of airspace segregations- airspace zones, through airspace with routes, to free airspace, while the supporting infrastructures will start from droneports to

specific "U-ports" with passenger terminals, parking lots, etc.

In order to manage future traffic growth in the following years, safely while mitigating the environmental impact, UAV management systems in smart cities are needed. In the full integration scenario (S3 and beyond), it will be expanded into a UTM concept like ATM is for manned aviation.

Moving towards autonomy, UAVs rely on collision avoidance systems, which are recognized as the most important prerequisite for their safe integration into the airspace with manned aircraft, as they present direct and last system barriers to prevent mid-air collisions.

The safety risk management approaches are needed to be proactive, with developed and implemented SMS, including Emergency and Contingency Plans, within all stakeholders.

To conclude, to enable the safe integration of UAVs in smart cities, it is needed to develop and implement solutions that cover operational, technical, and safety requirements. This paper proposed mentioned solutions as strategies that should be applied in the coming years, considering different levels of UAV integration in smart cities in the next 15 years.

As mentioned, with the presence of a large number of UAVs and manned aircraft that will be expected in the following years, air traffic control services will be under the highest pressure, so the introduction of advanced digital technologies, followed by an appropriate regulatory framework will be needed. Thus, future research will be also expanded to the incorporation of digital transformation principles and changes that it will bring to the concept of UAV management systems for smart cities, as it will have a great impact on achieving a high level of aviation safety.

## 6 References

- [1] Mohammed F., Idries A., Mohamed N., Al-Jaroodi J. and Jawhar I., "UAVs for smart cities: Opportunities and challenges", 2014, International Conference on Unmanned Aircraft Systems (ICUAS) pp. 267-273.
- [2] Schubert F., "The development of the UAS traffic management (UTM) an air navigation services perspective", 2016, available at: <https://gutma.org/blog/2016/05/12/development->

uas-traffic-management-air-navigation-services-perspective/ (accessed March, 2023).

AEAT. ISSN: 0002-2667, DOI 10.1108/AEAT-10-2021-0313.

- [3] EASA Easy Access Rules for Unmanned Aircraft Systems, 2022, available at: <https://www.easa.europa.eu/en/document-library/easy-access-rules/easy-access-rules-unmanned-aircraft-systems-regulations-eu> (accessed April, 2023).
- [4] Bharadwaj S., Carr S., Neogi N., Topcu U., "Decentralized Control Synthesis for Air Traffic Management in Urban Air Mobility", 2021, IEEE Transactions on Control of Network Systems, vol.8, no.2, pp.598-608.
- [5] Nguyen D. D., "Developing Models for Managing Drones in the Transportation System in Smart Cities", 2019, Sciendo, vol. 15, no. 2, pp. 71., available at: <https://sciendo.com/pdf/10.2478/ece-2019-0010> (accessed April, 2023).
- [6] Nguyen D.D. Rohacs J. and Rohacs D., "Autonomous Flight Trajectory Control System for Drones in Smart City Traffic Management", 2021, ISPRS International Journal Geo-Information Vol. 10, 338.
- [7] Rathee G., Kumar A., Kerrache C. and Iqbal R. "A trust-based mechanism for drones in smart cities", 2022, IET Smart Cities, 4. 10.1049/smc2.12039.
- [8] Tomić L., Čokorilo O., "Drones Usage in Urban Areas as an Environmentally- Friendly Solution", 2021, 19th EPTS Congress - European Green Deal Challenges and Solutions; Maribor, Slovenia.
- [9] European Civil Aviation Conference - ECAC, 2021, Bulletin on Unmanned Aircraft Systems "UAS Bulletin".
- [10] CORUS-XUAM "U-space ConOps", 2022, Edition 3.10, available at: <https://corus-xuam.eu/new-u-space-conops/> (accessed April, 2023).
- [11] Mihajlović Z., Drašković B. and Čokorilo O., "The influence of passenger behavior and economy measures on air traffic recovery after covid-19 crisis", 2020, ICTS 2020 Conference, Portorož, Slovenia.
- [12] Bagaric T., Steiner S., "Safety aspects of UAS integration in pan-European airspace", 2012, 4th International Maritime Science Conference – IMSC, June 16th-17th, 2012, Split, Croatia.
- [13] Tomić, L., Čokorilo, O., Vasov, Lj., Stojiljkovic, B., „ACAS installation on unmanned aerial vehicles: effectiveness and safety issues”, (2022) Aircraft Engineering and Aerospace Technology -
- [14] SESAR, "European ATM Master Plan: Digitalising Europe's Aviation Infrastructure", 2020. (accessed Feb., 2023).

# The development of mobility in urban areas - examples of good practices

Milena Ninović, Slaviša Dumnić, Đorđije Dupljanin

Faculty of Technical Sciences, Trg Dositeja Obradovića 6, 21000 Novi Sad, Republic of Serbia

## Abstract

Mobility development in urban centers is crucial to creating a livable and sustainable urban environment. With more and more people moving to cities every year, it is essential to have a safe, efficient, and accessible transport system. The paper examines the concept of sustainable urban mobility and analyzes the differences between traditional and sustainable transportation planning. Additionally, the main goal is to provide nine actionable proposals for developing urban mobility with examples of successful practices. By implementing the suggested actions, an urban environment suitable for living would be created, and the harmful effects of traffic as a crucial element of economic and social development would be reduced. To create a sustainable future for urban environments and lay the foundations for smart cities, it is necessary to develop sustainable concepts for urban development, reduce traditional modes of transportation, and raise awareness of environmental sustainability.

**Keywords:** *urban mobility, sustainable traffic, sustainable transport, sustainability*

## 1 Introduction

Intensive technical-technological, economic, and social development, population growth, an accelerated way of life, and many other factors, despite the benefits they bring to the population, have a negative effect on the sustainable development of cities. In this context, traffic plays a special role. In addition to all its positive sides and positive economic and social effects, it is the most important factor that negatively affects the environment of cities. Numerous data on urban traffic indicate an increasing flow of traffic and traffic congestion in cities.

Cities are networks of activity and, as such, represent a key element in the world's production, consumption, and creation of pollution and waste [1]. Today, over 4 billion people live in urban areas, and by the middle of this century, nearly two-thirds of the world's population will live in cities [2].

Traffic greatly affects the sustainability and quality of life in cities. According to the Intergovernmental Panel on Climate Change

(IPCC), the transport sector is responsible for 14% of total greenhouse gas emissions globally [3]. However, in urban areas, the share of emissions of harmful gases from traffic can be much higher, due to traffic jams and the frequent stops and starts of vehicles.

Urban areas are faced with air pollution, noise, congestion, public space occupancy with traffic, and mortality rates caused by traffic accidents and pollution [3, 4]. In 2019, direct greenhouse gas (GHG) emissions from the transport sector were 8.7 GtCO<sub>2</sub>-eq (up from 5.0 GtCO<sub>2</sub>-eq in 1990) and accounted for 23% of global energy-related CO<sub>2</sub> emissions. 70% of direct transport emissions came from road vehicles, while 1%, 11%, and 12% came from rail, shipping, and aviation, respectively [3]. There is a danger that CO<sub>2</sub> emissions from transportation could grow in the range of 16% and 50% by 2050 [3].

In recent decades, it has become very important to reduce the impact of traffic on the environment, and this can be achieved through the planning of urban areas, taking into account all road users, both passive and active, while bearing

---

Corresponding author: [milenaninovic@uns.ac.rs](mailto:milenaninovic@uns.ac.rs)

© 2023 The Author(s). This work is licensed under a Creative Commons Attribution 4.0 International License.

in mind the ultimate goal of increasing the quality of life while reducing the negative impact.

The development of urban mobility is mentioned in the scientific literature as a solution to the previously analyzed problems in urban areas. Numerous authors deal with this issue from different perspectives [5-9]. In the paper [10], a systematic review of 62 scientific papers was given, describing 52 potential scenarios for urban mobility development until 2030.

This paper presents a proposal for nine actions for urban mobility development, as well as examples of successful practices.

## **2 The concept of sustainable urban mobility**

Sustainable urban mobility refers to the movement of people and goods within urban areas in a way that is environmentally, economically, and socially sustainable. It involves the use of renewable energy sources, reducing pollution and noise, improving transport efficiency, encouraging alternative modes of transport such as cycling, walking, and public transport, as well as improving the infrastructure and organization of urban transport. The authors of papers [11, 12] address various aspects of sustainable urban mobility, such as climate change, integration of transport planning, and urban development, as well as the need for further research in this area. The papers mainly highlight significant challenges and opportunities in implementing sustainable urban mobility in different contexts and emphasize the need for an integrated and holistic approach to urban traffic planning and management.

Urban mobility can be viewed through three basic categories: public transport (buses, trams, trolleybuses, trains), individual transport (cars, bicycles, scooters, walking), and freight transport (trucks, freight trains, etc.) [13]. Each of these categories is a key element of functional urban mobility. As urban environments grow, so does the challenge of effectively organizing and synchronizing these elements. The increase in the number of vehicles on the road does not necessarily mean an increase in mobility. On the contrary, it results in traffic jams, congested public areas, pollution, wasted time, and, in the most extreme cases, loss of life.

Technology development has particularly affected urban mobility [10]. Various factors influence the future paths of urban mobility, including automation, sharing mobility, electric vehicles, congestion, greenhouse gas emissions, and social attitudes [10].

There is a growing demand for mobility services, including passenger and freight transport, which leads to severe problems in larger cities, such as congestion and air pollution [14]. Finding a balance between economic sustainability, environmental regulations, and travelers' needs is a key challenge for future urban mobility [15].

For years, European cities have been systematically favoring alternative modes of movement, primarily non-motorized modes of transport, that reduce the use of fossil fuels. These individual efforts of cities, have been translated into the official policy of the European Union and have become part of the so-called "Mobile Package" [16], which was adopted in 2013. The "Mobile Package" is a set of European policies aimed at reducing greenhouse gas emissions from transport and promoting alternative fuels and technologies. This package includes a set of recommendations aimed at reducing CO<sub>2</sub>, fuel quality standards, plans for alternative fuels in Europe, and more [16]. The implementation of the "Mobile Package" in the European Union has contributed to reducing emissions of harmful gases in transport and increasing the use of alternative fuels and technologies. However, it is necessary to continue developing and implementing policies that will support sustainable mobility and contribute to the fight against climate change.

## **3 Difference between traditional and sustainable traffic planning**

Traditional traffic planning focuses on improving vehicle flow and the faster movement of people and goods. Such planning usually does not take into account long-term environmental impacts. Traditional urban planning has not accompanied the growth of the population living and working in cities, which causes congestion and pollution in many urban areas. Sustainable traffic planning focuses on the balance between mobility, the environment, and social factors. Table 1 provides an overview of the differences

between traditional and sustainable transport planning [17].

**Table 1.** Difference between traditional and sustainable traffic planning [17]

<b>Traditional traffic planning</b>	<b>Sustainable traffic planning</b>
Focus on traffic	Focus on people
Primary goals: Motorized traffic flow and speed of movement	Primary goals: Accessibility and quality of life, including social equality, health, environmental quality, and economic sustainability
Infrastructure is the main subject of planning.	Infrastructure is one way to achieve wider goals.
Focus on the development of certain modes of transport (e.g., separate plans for the development of public transport, for encouraging cycling, and for building car parking).	Development of all modes of transport and transition to sustainable mobility.
Project planning	Strategic and coordinated planning
Short and medium-term planning	Short- and medium-term planning is an integral part of the long-term vision and strategy
of traffic engineers	The domain of interdisciplinary planning teams
The plan covers only one territorial unit	The plan covers the entire urban area based on people's movements

#### 4 Action proposals for the successful implementation of urban mobility

The following are proposals for actions to successfully implement sustainable urban mobility in line with the European Commission's recommendations. Examples of successful implementation of urban mobility elements in cities around the world will also be presented.

##### 4.1 Encouraging the use of active transportation, such as walking and cycling, through the creation of dedicated infrastructure and programs

Encouraging the use of active transportation, such as walking and cycling, can have numerous positive effects on society and the environment. Creating dedicated infrastructure and programs can be key in encouraging people to use these modes of transportation more. The reasons for promoting active transportation include reducing traffic congestion, air pollution, and noise, thereby improving the quality of life in urban areas.

Dedicated infrastructure, such as bike lanes and pedestrian zones, can be crucial in encouraging people to use active transportation more. In addition to infrastructure, programs that encourage the use of active transportation can also be helpful. For example, campaigns can be organized to encourage people to walk or bike to work or school, or to use a bike as an alternative to public transportation. Events such as bike races or marathons can also attract people and encourage them to use active transportation more. Several researchers [18, 19] suggest that human-powered micro-mobility (cycling, scootering, and walking) should dominate mobility packages.

The European Union aims to reduce greenhouse gas emissions by at least 55% by 2030 compared to 1990 levels [20]. One way it plans to achieve this is by encouraging people to use active transportation, such as walking and cycling, more. In May 2021, the European Commission published an Action Plan [16] for walking and cycling mobility, which aims to increase the use of these modes of transportation and improve infrastructure for them. European cities known for their well-developed cycling networks include Amsterdam, Copenhagen, Utrecht, Munich, Berlin, and Strasbourg.

##### 4.2 Giving priority to public transportation, in order to reduce traffic congestion and emissions of harmful gases

Giving priority to public transport is an important concept for reducing congestion and harmful gas emissions in cities. This concept refers to giving preference to public transport over private vehicles in transportation. There are several ways in which cities can give priority to public transport. For example, cities can establish

special lanes for buses or trams, that allow them to bypass congestion. It is also possible to install signaling that gives priority to public transport, which speeds up the movement of public transport and improves its reliability.

In some cities, giving priority to public transport is combined with other policies, such as high parking fees or taxes on high-emission vehicles. This approach has been effective in reducing congestion and harmful gas emissions.

European cities that are particularly advanced in giving priority to public transport include Vienna, Zurich, Strasbourg, Copenhagen, Amsterdam, and others. These cities have efficient public transport networks, offer free bike rentals, low prices, or free transport for certain groups of citizens, have special lanes for public transport, and more.

There are numerous initiatives in Europe that emphasize public urban transport. Some of them are European Mobility Week [16], European Smart Cities Initiative [21], Investments in Sustainable Transport Projects [16].

The introduction of free public transport is becoming a more important part of traffic policies. For example, in the Republic of Serbia, in the cities of Knjaževac, Jagodina, and Zaječar, public transport is free for users, i.e., fully financed from the public budget. The administration of Knjaževac introduced this measure in 2015 to improve the connectivity of suburban settlements and villages with the city and to enable better access to urban functions and services for the entire municipality's population. In Jagodina, since 2019, public transport has been free for all citizens of Jagodina, visitors from other parts of Serbia, as well as foreign tourists. Since April 2019, Zaječar has been providing free public transport on local lines for all residents of that city. In all of these cities, passenger transport is provided by private companies, which are paid for their services from the local budget.

#### **4.3 Develop comprehensive transportation plans that take into account the needs of all users, including pedestrians, cyclists, and drivers**

Developing comprehensive transportation plans that take into account the needs of all users, including pedestrians, cyclists, and drivers, as well as people with disabilities and older people, means developing plans that focus on creating a

balanced, efficient, and sustainable transportation system. This involves considering the needs of all transportation users and ensuring that their needs are met, not only in terms of safety and efficiency but also in terms of inclusion and accessibility.

The development of comprehensive transportation plans usually involves an analysis of existing transportation systems, population needs, strategic goals, and sustainable development objectives, as well as the development of action plans for implementation.

Comprehensive transportation plans also involve the design and implementation of physical infrastructure projects, such as the construction of bicycle lanes, pedestrian zones, public transportation, parking, and other similar facilities. These projects are designed to create a more sustainable and efficient transportation system that will be accessible and safe for all users.

When comprehensive transportation plans are successfully implemented, they can bring numerous benefits, including reducing traffic congestion, reducing air pollution, improving connectivity and mobility, increasing transportation efficiency, and increasing traffic safety. In addition, such plans can be crucial in supporting sustainable development and reducing the negative impacts of transportation on the environment.

European cities that have developed comprehensive transportation plans that take into account the needs of all users include Copenhagen, Amsterdam, Barcelona, Vienna, Stockholm, Berlin, Paris, London, and others.

#### **4.4 Incentives for using shared mobility, such as carpooling and bike-sharing**

Incentives for using shared mobility, such as carpooling and bike-sharing, can have many benefits for individuals, communities, and the environment. To reduce negative externalities and raise user satisfaction, shared mobility is identified as one of the most promising solutions for urban mobility [22]. These options allow people to share a car or bike instead of owning one, reducing the need for parking and the amount of exhaust emissions.

To encourage the use of shared mobility, various programs, and initiatives can help, such as subsidies for public transportation, discounts for

using carpooling, and bike-sharing. Another useful option is making decisions that facilitate carpooling or bike-sharing, such as designating parking spaces and using yellow lanes.

Examples of bike-sharing and car-sharing services include Uber, Lyft, BlaBla Car etc.

#### **4.5 Promoting the use of electric and low-emission vehicles through infrastructure development**

Urban mobility can be reduced by switching to low- and zero-emission modes, enhancing the role of electric vehicles [23, 24]. The use of electric vehicles directly contributes to reducing air pollution in cities. Electric vehicles do not produce exhaust gases such as carbon monoxide, nitrogen oxides, particles, and other pollutants produced by internal combustion engine vehicles such as gasoline and diesel cars. Additionally, electric vehicles can be charged from renewable sources of energy such as solar and wind energy, further reducing greenhouse gas emissions. However, there are challenges and disadvantages that still need to be addressed to achieve the wider success of this system: cost, charging infrastructure, range of electric vehicles, battery production, energy use, and recycling.

There are European initiatives to promote the use of electric and low-emission vehicles through infrastructure development. One of the main initiatives in this regard is the European Strategy for Sustainable Mobility, which was adopted in 2018 [16]. This strategy aims to develop infrastructure for electric and low-emission vehicles. The European Union has also adopted several other similar initiatives:

- The European Plan for Investment in Trans-European Energy Infrastructure (TEN-E), which includes the development of charging infrastructure for electric vehicles along European highways [16];
- The Clean Energy for EU Cities initiative, supports cities in developing sustainable transport systems, including infrastructure for electric vehicles [16];
- The Connecting Europe Facility program (CEF), finances projects in the field of transport infrastructure, including projects for the development of infrastructure for electric and low-emission vehicles [16].

To promote the use of electric and low-emission vehicles, some cities offer incentives, tax breaks, loans, and leases.

By using AVs, the transport system is expected to perform better, for example, by distributing routes efficiently [25] providing safer transportation, offering individuals without driving licenses individual travel options, boosting energy efficiency, and improving land use [26].

#### **4.6 Formulating parking management strategies**

Parking management strategies, including pricing and time restrictions, are important tools for regulating the use of public parking spaces in cities. This approach is usually applied in densely populated urban areas to reduce congestion and increase parking availability for residents and visitors. There are several different parking management strategies, with the two most common being paid parking and time restrictions. Many cities in Europe have successfully implemented parking management strategies to reduce pollution. Some of the most advanced European cities in this regard are Amsterdam, Barcelona, Stockholm, and Copenhagen. Each of these cities also implements other actions and incentives listed in this paper to reduce pollution.

By implementing strategies such as high prices and time restrictions for parking, cities can encourage the use of alternative modes of transportation, such as public transit, cycling, and walking. Cities are also increasingly considering the introduction of dynamic pricing for parking, which adjusts parking prices based on demand.

#### **4.7 Network of safe and accessible sidewalks and bicycle paths**

A network of safe and accessible sidewalks and bike paths is a system of connected sidewalks and bike paths that allow people to move through cities and towns safely and efficiently by walking or by bicycle. This network can include lanes, paths, bridges, and tunnels, and provides connectivity to key destinations in the city, such as business, educational, and residential areas, public transport, parks, and other places.

Safety and accessibility are key elements of this network, which means ensuring that sidewalks and bike paths are accessible and safe

for all users, especially children, the elderly, and people with disabilities.

A network of safe and accessible sidewalks and bike lanes can reduce travel time and costs, and improve productivity, and economic development. Also, it must be continuously maintained and expanded to ensure sustainable and safe mobility for all people in cities and towns. The cities that stand out in this regard are Copenhagen (with about 400 km of bicycle paths), Amsterdam (about 500 km of bicycle paths), Barcelona (180 km), and Portland, USA (550 km).

In the period from 2006 to 2016, through sustainable urban mobility planning, Ljubljana managed to move traffic from the city center and thus encourage the development of the center as a tourist, trade, and hospitality zone; to introduce measures to encourage the use of bicycles as a means of transportation, primarily by investing in the construction of quality bicycle infrastructure and the introduction of a public bicycle system that currently has 32,000 registered users; to improve public transport by introducing ecological buses, and to receive the title of Green Capital of Europe for 2016, in recognition of the successful management of sustainable development policy in the field of transport. The city administration claims that careful planning of the traffic policy, with ambitious goals and a clear, persistently implemented strategy, was of key importance for the success of this strategy.

#### **4.8 Encourage a culture of active transportation and sustainable mobility through education and information programs**

Education and information programs can help inform the public about the benefits of sustainable mobility and also encourage people to use alternative modes of transportation. What is even more important, these kinds of programs prepare the youngest to use the city and its resources more intelligently. Programs that target specific groups, such as school-aged children, adults, and people with disabilities, are extremely important.

#### **4.9 Cooperation with organizations and agencies, to develop a cohesive and integrated approach to transport**

Cooperation at the intercity level can lead to useful exchanges of experience. It would be useful for cities to review the needs of their users and listen to the public. Dialogue with transportation companies, transporters, and organizations can bring positive ideas. This can help improve coordination between different modes of transport, as well as increase the effectiveness of transportation policies and programs. The development of mobility in the city center is a complex and continuous process that requires the active participation of the community, government organizations, and the private sector.

Organizations and agencies that can be involved in the development of a cohesive and integrated approach to transport can be City and local authorities; transportation agencies; private companies and others. This cooperation can be achieved through various activities, such as the development of common goals; exchange of information; development of partnerships.

### **5 Conclusion**

Observing the European cities that work intensively to change the approach in urban traffic planning, it is possible to see good practices to plan sustainable urban mobility in our environment as well. As already mentioned, there are a large number of examples of cities that have successfully implemented urban mobility policies, which has led to visible results in improving the quality of life. The positive example of Ljubljana contributed to this city winning the prestigious title of the Green Capital of Europe, and hundreds of thousands of tourists testify to the increased activity of this city for both residents and visitors. For cities that want to seriously deal with urban mobility, networking is recommended, at the level of states, regions, and beyond. As sustainable urban mobility is a concept strongly supported by the European Commission, there are a large number of European networks and initiatives that help in the exchange of experience and knowledge. In order for each of the proposed actions to be improved, researchers must direct their focus to a more detailed examination of them in order to find potential shortcomings and obstacles to their



implementation. Also, states, in line with their capabilities, should adjust their sustainability policies and propose initiatives to improve the quality of life in cities through the gradual development of urban mobility.

### Acknowledgement

This research has been supported by the project "Development and application of modern methods and technologies in education and research in traffic and transportation", founded by the Department of Traffic Engineering, Faculty of Technical Sciences in Novi Sad, University of Novi Sad, Republic of Serbia.

### References

- [1] Vračarević, B. "Održivi urbani razvoj i determinante potrošnje energije u saobraćaju gradova: teorijsko-empirijska analiza". Univerzitet u Beogradu , 2019.
- [2] United Nations, "World Population Prospects: The 2015 Revision": [https://esa.un.org/unpd/wpp/publications/files/key\\_findings\\_wpp\\_2015.pdf](https://esa.un.org/unpd/wpp/publications/files/key_findings_wpp_2015.pdf)
- [3] Intergovernmental Panel on Climate Change (IPCC) Report: [https://www.ipcc.ch/report/ar6/wg3/downloads/report/IPCC\\_AR6\\_WGIII\\_Chapter10.pdf](https://www.ipcc.ch/report/ar6/wg3/downloads/report/IPCC_AR6_WGIII_Chapter10.pdf)
- [4] Bosetti, S.; Di Bartolo, C.; Malgieri, P.; Sitran, A.; Bruhová-Foltýnová, H.; Jordová, R.; Kurfürst, P.; Smutková, D. "Policy Recommendations for EU Sustainable Mobility Concepts Based on CIVITAS Experience"; CDV: Brno, Czech Republic, 2014
- [5] Bertolini, L. "From "streets for traffic" to "streets for people": can street experiments transform urban mobility?". *Transport reviews*, 2020, 40(6), 734-753.
- [6] Al-Thani, H., Koç, M., Isaifan, R. J., Bicer, Y. A "Review of the Integrated Renewable Energy Systems for Sustainable Urban Mobility". *Sustainability*, 2022, 14(17), 10517.
- [7] Kovačić, M., Mutavdžija, M., Buntak, K. New "Paradigm of Sustainable Urban Mobility: Electric and Autonomous Vehicles—A Review and Bibliometric Analysis". *Sustainability*, 2022, 14(15), 9525.
- [8] Punzo, G., Panarello, D., & Castellano, R. "Sustainable urban mobility: evidence from three developed European countries". *Quality & Quantity*, 56(5), 2022, 3135-3157.
- [9] Pisoni, E., Christidis, P., Thunis, P., & Trombetti, M. "Evaluating the impact of "Sustainable Urban Mobility Plans" on urban background air quality". *Journal of environmental management*, 2019, 231, 249-255.
- [10] Miskolczi, M., Földes, D., Munkácsy, A., Jászberényi, M. "Urban mobility scenarios until the 2030s". *Sustainable Cities and Society*, 2021, 72: 103029.
- [11] Macedo, J., Rodrigues, F., Tavares, F. "Urban sustainability mobility assessment: Indicators proposal". *Energy Procedia*, 2017, 134, 731-740.
- [12] Regmi, M. B. "Measuring sustainability of urban mobility: A pilot study of Asian cities". *Case studies on transport policy*, 2020, 8(4), 1224-1232.
- [13] BCG, "The Future of urban mobility" <https://www.bcg.com/publications/2022/the-future-of-urban-mobility>
- [14] Becker, H., Becker, F., Abe, R., Bekhor, S., Belgiawan, P. F., Compostella, J., ... Axhausen, K. W. "Impact of vehicle automation and electric propulsion on production costs for mobility services worldwide". *Transportation Research Part A: Policy and Practice*, 2020, 138, 105-126.
- [15] Canitez, F. "Pathways to sustainable urban mobility in developing megacities: A socio-technical transition perspective". *Technological Forecasting and Social Change*, 2019, 141, 319-329.
- [16] European Commission [https://commission.europa.eu/index\\_en](https://commission.europa.eu/index_en)

- [17] Wefering, F., Rupprecht, S., Bührmann, S., Böhler-Baedeker, S. "Guidelines. Developing and implementing a sustainable urban mobility plan". In Workshop, 2013, p. 117.
- [18] Jittrapirom, P., Caiati, V., Feneri, A. M., Ebrahimigharehbaghi, S., Alonso González, M. J., Narayan, J. "Mobility as a service: A critical review of definitions, assessments of schemes, and key challenges", 2017.
- [19] Sochor, J., Strömberg, H., Karlsson, I. M. "Implementing mobility as a service: challenges in integrating user, commercial, and societal perspectives". *Transportation research record*, 2015, 2536(1), 1-9.
- [20] European Investment Bank, "Investment Report 2022/2023: Resilience and renewal in Europe": [https://www.eib.org/en/publications/online/all/investment-report-2022-2023?gclid=Cj0KCQjwt\\_qgBhDFARIsABcDjOdDM3sR9R-x1LzMv14wFi-MWp0HfsRtcpYOLWKMnem1PiXH\\_0G5Mn8aAt0yEALw\\_wcB](https://www.eib.org/en/publications/online/all/investment-report-2022-2023?gclid=Cj0KCQjwt_qgBhDFARIsABcDjOdDM3sR9R-x1LzMv14wFi-MWp0HfsRtcpYOLWKMnem1PiXH_0G5Mn8aAt0yEALw_wcB)
- [21] European Commission, "Shaping Europe's digital future": <https://digital-strategy.ec.europa.eu/hr/policies/smart-cities-and-communities>
- [22] Standing, C., Standing, S., Biermann, S. "The implications of the sharing economy for transport". *Transport Reviews*, 2019, 39(2), 226-242.
- [23] Ferrero, F., Perboli, G., Rosano, M., Vesco, A. "Car-sharing services: An annotated review. *Sustainable Cities and Society*, 2018, 37, 501-518.
- [24] Lee, C. M., Erickson, P. "How does local economic development in cities affect global GHG emissions?". *Sustainable Cities and Society*, 2017, 35, 626-636.
- [25] Pauer, G., Török, A. "Static system optimum of linear traffic distribution problem assuming an intelligent and autonomous transportation system". *Periodica Polytechnica Transportation Engineering*, 2019, 47(1), 64-67.
- [26] Torok, A., Derenda, T., Zanne, M., Zoldy, M. "Automatization in road transport: a review". *Production Engineering Archives*, 2018, 20(20), 3-7.

# Mobile alternative delivery points

Dragana Šarac, Nataša Čačić, Bojan Jovanović

University of Novi Sad, Faculty of Technical Sciences, Trg Dositeja Obradovića 6, 21102 Novi Sad, Serbia

## Abstract

The rapid development of e-commerce directly affects the growth of delivery demands for goods and documents. As per our research, customers prefer home delivery. Research in the U.K. reported that the rate of failed first deliveries of home delivery was 12%. This result is caused by the fact that half of homes are empty from 9 a.m. to 4 p.m. on weekdays largely due to changes in the lifestyle. Redelivery is an important source of delivery costs. Additional trips also cause more environmental pollution. Developing alternative delivery points, to enable customers to participate in last-mile delivery is a promising solution. The most popular solution for alternative delivery points is fixed parcel locker, which supports unattended delivery. Fixed parcel lockers, however, have some inherent limitations. First, their location and configuration are fixed in place, which brings poor accessibility and ability to respond to change of demands. Moreover, the fixed parcel lockers have high requirements for information and communication technology (ICT) and can't be set up in old residential areas. In addition, high construction costs are required. This paper proposes an alternative delivery model. The model implies the use of existing resources. The aim is to minimize the operating cost for the home delivery and to offer customers more mobile alternative delivery points near their homes.

**Keywords:** optimization, model, delivery points, postal network

## 1 Introduction

The market of postal services is a place where offering and demand for services meet. This market requires constant monitoring of customers, their needs, and the degree of satisfaction with the services provided to them. The rapid development of e-commerce directly affects the growth of demand for the delivery of goods and documents. Postal operators create their services based on market needs. Postal service providers are modernizing their ways of doing business as a result of new development trends. They create location tracking systems, and GPS systems, where each vehicle is equipped with a GPS receiver to allow the vehicle to be positioned at any time. In this way, postal operator base stations can receive current information both on the location of the delivery vehicle and the current location of the postal items being transported in the vehicle. The application of software tools in modern business has great importance.

A plan, on how the routing of postal items should work in the postal system was presented in the paper [1]. In the papers [2]-[3]-[4] the need for monitoring and control of shipments during transport was emphasized, where the role and possibility of RFID and GPS technology in the organization and rationalization of the transport of postal shipments were shown. The paper [5], also talk about the importance of applying new forms of delivery and tracking postal items. Research on the mutual coexistence of active and passive RFID technology in the field of postal and logistics network optimization and transport processes was analyzed in the work [6]. The paper [7] discussed the application of ICT technology in courier services. The authors gave the algorithm of dynamic routing which is of the heuristic kind and is based on principles different from those already used, for solving transportation problems. The paper [8] also talks about the importance of tracking postal items.

---

Corresponding author: Nataša Čačić (ncacic@uns.ac.rs)

© 2023 The Author(s). This work is licensed under a Creative Commons Attribution 4.0 International License.

Tracking of postal items is a process that enables customers to receive timely information about the status of their item, from the moment when an item enters the system i.e. where the item is currently in the technological process phase. With this paper, an alternative delivery model was proposed. When the postal item is in the delivery vehicle, the customer can check where the item is currently located in the delivery area Algorithm 1. With this method of information, the customer has an insight into when exactly he can expect his item at the address or pick it up personally in the area from the deliverer. Having information about where the postal item is at any given moment improves the quality of the service and fulfills the company's strategic goals and customer satisfaction.

Postal operators in the world, to reduce costs and meet the needs of customers, have included parcel lockers as a modern way of the service point. A large number of scientific works deal with the analysis of the efficiency and functionality of the parcel locker. According to the analysis of the efficiency and usability of parcel lockers in the example of the Polish InPost company [9], it was established that it is the right choice for shaping future delivery systems in cities. The paper [10] investigates the impact of parcel lockers concerning traveled distances as well as CO<sub>2</sub> emissions. The choice of parcel locker location is also very important. Correct positioning of the parcel lockers means being able to reach a greater number of potential customers and make the delivery service competitive regarding home delivery [11]. The authors of the paper [12] bilevel programming (BLP) model is established to identify the optimal location for parcel lockers by considering the benefits to consumers and logistics planning departments. Bearing in mind that last-mile delivery is associated with a negative impact on the environment and high costs, in the paper [13] the design of a stationary parcel locker (SPL) was considered. The authors of the paper [14] dealt with the comparison of traditional delivery and delivery through parcel lockers. The authors developed a quantitative activity-based model for estimating kgCO<sub>2</sub>e and the operational costs. A comparison of the effects of classic delivery and delivery via parcel locker in urban and rural areas was also analyzed in the paper [15]. It was concluded that, based on the observed parameters, parcel lockers are a better solution in both urban and rural areas. In the working paper [16] a new

concept for last-mile distribution was developed. The new concept describes mobile parcel lockers that can change their location during the day, whether autonomously or moved by a driver. The results show that mobile lockers are a better solution than stationary lockers. The work that also deals with the optimization of the mobile parcel locker location is presented in [17] and aims to develop an optimization model to locate movable parcel locker units and determine the number of units under stochastic demands. In the cities of Polan, research was carried out on the usability of the parcel lockers from the customer's perspective [18]. It has been established that the popularity of parcel lockers will continue to grow in the future.

This paper proposes an alternative delivery model. The model implies the use of existing resources. The aim is to minimize the operating cost for home delivery and to offer customers more mobile alternative delivery points near their homes. Also, in support of the analysis of mobile alternative delivery points a survey was conducted among customers of postal services in the form of a questionnaire. The analysis of the obtained results indicates that the new alternative delivery model would be a good solution that would meet the needs of customers.

## **2 Research results**

### **2.1 Respondents` answers to the survey questionnaire**

For this paper, a survey questionnaire of the postal services market was conducted. As part of the survey questionnaire, customers were asked questions of interest to observe customers' attitudes related to the methods of delivery of postal items. The analysis included 409 respondents in the territory of the Republic of Serbia. The results are presented in Fig. 1-3.

Processing the questionnaire leads to the conclusion that for the largest number of customers, as many as 331 are the first choice of delivering parcels to their home address, while 9 customers opted for delivery via parcel lockers (Fig. 1). This situation indicates that the majority of customers still prefer to have their package delivered to their home address.

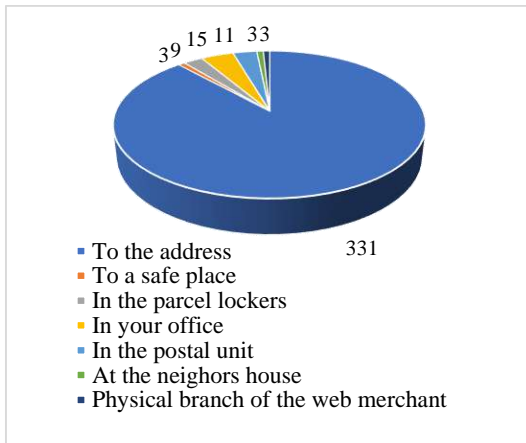

**Fig. 1.** What is your first choice of postal item delivery?

As for the frequency of using parcel lockers, 259 customers never use them, while only 3 surveyed customers always use them (Fig. 2).

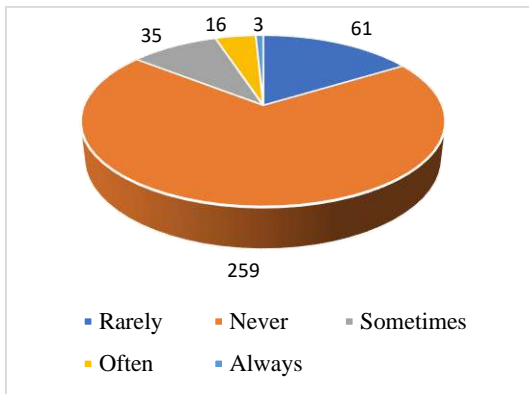

**Fig. 2.** How often do you use parcel lockers as a delivery service?

As a reason for non-using parcel lockers, 134 customers state that they do not exist in their place of residence, while 36 surveyed customers are dissatisfied with the location of existing parcel lockers (Fig. 3).

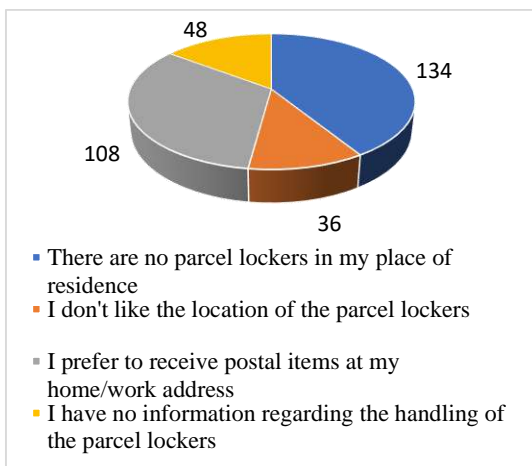

**Fig. 3.** If you have not used a parcel locker before, state the reason

These results indicate that in the process of making decisions about the location of parcel lockers, a larger number of factors should be included for analysis. Also the needs of customers and the possibilities of other alternative delivery solutions should be explored in more detail.

## 2.2 Algorithm for mobile alternative delivery points

Existing alternative delivery models in the form of mobile and stationary parcel lockers have their advantages and disadvantages. This paper presents a new mobile alternative delivery points model. The model implies the use of available resources, does not require additional financial investments, and minimizes the existing costs of home delivery.

The model for mobile alternative delivery points is shown by Algorithm 1. This algorithm describes in detail the procedure from the creation of a delivery bill by the postal operator to take over the postal items by the customer at the delivery area of the courier. With this mode of operation, customers can check the current location of their postal items in the region at any time through the created application. If the customer believes that he will not be at his home during the scheduled delivery time, he can personally go to the courier located in the area and take over the postal item. This model brings benefits to both customers and postal operators.

Research in the U.K. reported that the rate of failed first deliveries of home delivery was 12%. This result is caused by the fact that half of the homes are empty from 9 a.m. to 4 p.m. [19]. Most customers in the period from 9 a.m. to 4 p.m. are at their workplaces and are unable to receive their postal items. The result of absence of the customers at the residential address leads to the return of the postal item and a retry of delivery the next day. For postal operators, this situation creates additional costs (fuel consumption, depreciation, etc.) as well as unproductive time due to failed deliveries. With the proposed model for mobile alternative delivery points, by entering the postal item number in the application, customers could have insight into where the courier is currently located, when he will arrive at their address, or if they cannot wait for the courier, they can personally go to him and take over their postal item.

**Algorithm 1.** Algorithm for mobile alternative delivery point model

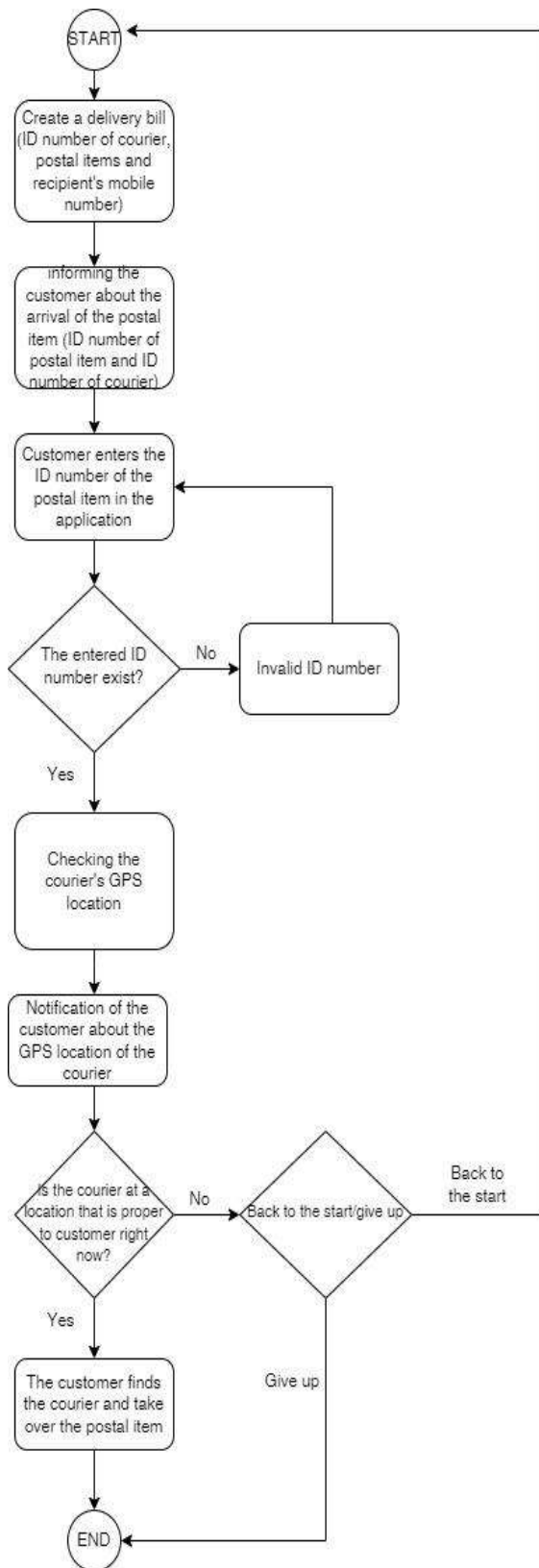

### 3 Analysis of the observed area of the city of Novi Sad

About 15 postal operators provide postal services in the area of the city of Novi Sad. Among them, only three operators: Public Enterprise Post of Serbia, Ananas e-commerce, and YU-PD Express, have their stationary parcel lockers installed in several locations on the territory of Novi Sad.

In the area of the city of Novi Sad, the delivery area of the settlement Grbavica, Limani (1-4) was observed. Currently, in the Republic of Serbia, one postal operator can only use his parcel lockers. There is no collaboration between operators in terms of sharing lockers. The analysis was performed based on data obtained from one private postal operator. Based on the data, it was determined that the observed operator has 51 stop points in the delivery area. According to the data on stop points, demand nodes were determined. Demands nodes and parcel lockers of observed operators were also viewed as potential nodes of service provision. Fig. 4 shows the location of the observed operators' parcel lockers and the places where the postal operator stops to provide service to customers. The red line represents the boundaries of the area within which the courier moves in the observed delivery area.

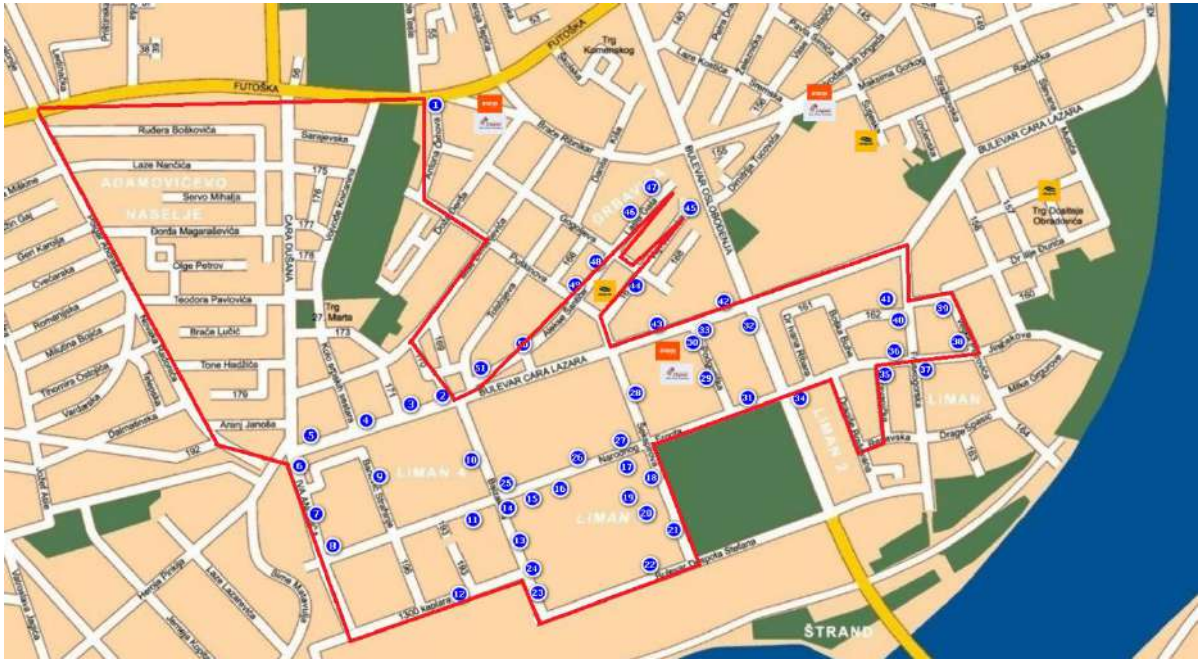

**Fig. 4.** Map of the observed delivery area

The numerical calculation of the distance was realized in the Matlab programming language. The obtained matrix 'A' of dimensions 51x51, represents the determined distances (expressed in meters) between the service demand nodes and mobile alternative delivery points. Matrix 'B' of dimensions 51x9, represents the determined distances (expressed in meters) between the service demand nodes and the parcel lockers.

$$A = \begin{bmatrix} 0 & 775 & 880 & 900 & 1000 & \dots \\ 775 & 0 & 134 & 250 & 260 & \dots \\ 880 & 110 & 0 & 130 & 296 & \dots \\ 900 & 210 & 130 & 0 & 150 & \dots \\ 1000 & 260 & 296 & 150 & 0 & \dots \\ \vdots & \vdots & \vdots & \vdots & \vdots & \ddots \end{bmatrix}$$

$$B = \begin{bmatrix} 150 & 150 & 1000 & 1000 & 1200 & 2100 & 1200 & 1200 & 1000 \\ 830 & 830 & 1250 & 1250 & 1380 & 1600 & 690 & 690 & 607 \\ 897 & 897 & 1400 & 1400 & 1550 & 1800 & 800 & 800 & 750 \\ 970 & 970 & 1580 & 1580 & 1620 & 1920 & 950 & 950 & 820 \\ 1150 & 1150 & 1700 & 1700 & 1800 & 2100 & 1100 & 1100 & 950 \\ \vdots & \vdots & \vdots & \vdots & \vdots & \vdots & \vdots & \vdots & \vdots \end{bmatrix}$$

The measured distances of 51 service demand nodes to mobile alternative delivery points and to stationary parcel lockers are given in Table 1-2. According to the calculations, the average distance of all service demand nodes to potential mobile alternative delivery points is **714.8m**,

while the average distance of all demand nodes to stationary parcel lockers is **1070m**. It can be concluded that, on average, customers would cross **355m** less if they take over postal items using mobile alternative delivery points.

**Table 1.** Average distance of each demand nodes to mobile alternative delivery points

Nodes	Distance	Nodes	Distance
1	<b>1225</b>	27	<b>515,3</b>
2	<b>639</b>	28	<b>542,6</b>
3	<b>725</b>	29	<b>551,43</b>
4	<b>788,8</b>	30	<b>578,2</b>
5	<b>908</b>	31	<b>592</b>
6	<b>960</b>	32	<b>624</b>
7	<b>951,5</b>	33	<b>558</b>
8	<b>1001</b>	34	<b>695,9</b>
9	<b>877,13</b>	35	<b>808,5</b>
10	<b>721,3</b>	36	<b>876,8</b>
11	<b>529,5</b>	37	<b>963,5</b>
12	<b>894</b>	38	<b>963</b>
13	<b>686,8</b>	39	<b>1054</b>
14	<b>784</b>	40	<b>895</b>
15	<b>621,5</b>	41	<b>901,8</b>
16	<b>497,7</b>	42	<b>619</b>
17	<b>541,9</b>	43	<b>529,13</b>
18	<b>581,8</b>	44	<b>612</b>
19	<b>614</b>	45	<b>738</b>
20	<b>598</b>	46	<b>703</b>
21	<b>710</b>	47	<b>824</b>
22	<b>702</b>	48	<b>627</b>
23	<b>692</b>	49	<b>566</b>
24	<b>650</b>	50	<b>494,2</b>
25	<b>598</b>	51	<b>489,6</b>
26	<b>529</b>		

**Table 2.** Average distance of each demand nodes to the stationary parcel lockers

Nodes	Distance	Nodes	Distance
1	<b>1000</b>	27	<b>960</b>
2	<b>1014</b>	28	<b>821</b>
3	<b>1143</b>	29	<b>722</b>
4	<b>1262</b>	30	<b>661</b>
5	<b>1416</b>	31	<b>768</b>
6	<b>1511</b>	32	<b>650</b>
7	<b>1602</b>	33	<b>645</b>
8	<b>1728</b>	34	<b>917</b>
9	<b>1522</b>	35	<b>915</b>
10	<b>1335</b>	36	<b>913</b>
11	<b>1540</b>	37	<b>969</b>
12	<b>1800</b>	38	<b>1016</b>
13	<b>1688</b>	39	<b>914</b>
14	<b>1500</b>	40	<b>860</b>
15	<b>1400</b>	41	<b>859</b>
16	<b>1375</b>	42	<b>594</b>
17	<b>1244</b>	43	<b>620</b>
18	<b>1208</b>	44	<b>578</b>
19	<b>1300</b>	45	<b>537,7</b>
20	<b>1327</b>	46	<b>542</b>
21	<b>1424</b>	47	<b>499</b>
22	<b>1600</b>	48	<b>595</b>
23	<b>1405</b>	49	<b>641</b>
24	<b>1318</b>	50	<b>750</b>
25	<b>1080</b>	51	<b>864</b>
26	<b>1015</b>		

Based on the available data of the postal operator, it was determined that the postal operator delivered **3,497** packages in the delivery area in one month. From that number of packages, daily, at least 10% of packages are not delivered to customers (about 367 packages per month). Taking into account this fact, potential savings in kilometers traveled by customers can be determined if they use a mobile alternative delivery point to take over postal items instead of

parcel lockers. The calculation of savings in kilometers driven by customers was performed only for packages that were not delivered to customers within the estimated frame time monthly. They represent potential customers of parcel lockers and mobile alternative delivery points.

$$367 \times 1070\text{m} = \mathbf{392.690\text{m}}$$

$$367 \times 714,8\text{m} = \mathbf{262.331\text{m}}$$



By comparing the obtained results, it can be concluded that customers, on average, monthly, if they use a mobile alternative delivery point to take over postal items, travel **130km** less than if they take over the postal items via the nearest parcel lockers. Seen on an annual basis, it is **1560 km** less.

#### 4 Conclusion

This paper proposes a new alternative delivery model that does not create additional costs for postal operators but implies the use of existing resources. The advantages of applying the proposed delivery model are numerous for both customers and postal operators. Some of the advantages of mobile alternative delivery points for postal operators are:

- Existing infrastructure and equipment (resources) are used
- There are no additional investment costs
- More productive work of couriers in the delivery area
- Saving time
- It is not necessary to rent a space as with parcel lockers
- There are no charging costs as with parcel lockers
- Less CO<sub>2</sub> emission

The benefits for customers are:

- Better information about the delivery time
- Personal take over postal items from the courier at the delivery area
- Saving time
- Less travel to the courier than to the parcel locker
- Saves on fuel consumption

The proposed model represents a universal approach that can be further applied to other delivery areas. Future research should be focused on the time and financial aspects of this model. An analysis of customer satisfaction with the proposed model is also suggested.

#### Acknowledgement

This research (paper) has been supported by the Ministry of Education, Science and Technological Development through the project no. 451-03-47/2023-01/200156: "Innovative scientific and artistic research from the FTS (activity) domain".

#### References

- [1] Dobrodolac, M., Lazarevic, D., & Zivanovic, M., "Software application for postal items routing as part of postal systems critical infrastructure," *Machines. Technologies. Materials*, 8(3), pp. 9-12, 2014.
- [2] Švadlenka, L., Dobrodolac, M., & Blagojevic, M., "Application of tracking technologies in the postal system. In *ICTTE 2016: proceedings of the 3rd International Conference on Traffic and Transport Engineering*. City Net Scientific Research Center," 2016.
- [3] Deljanin, A., Colakovic, A., & Muharemovic, E., "Rationalization of transport of postal shipment using GPS/RFID technology in Bosnia and Herzegovina," *Modern Traffic*, 34(1-2), pp. 26-31, 2014.
- [4] Švadlenka, L., "RFID in postal and courier services," *Supply chain management in services industry: an introduction*, pp. 68-74, 2007.
- [5] Martinović, J., "Upotreba dronova u dostavi," (Doctoral dissertation, University of Rijeka. Faculty of Maritime Studies, Rijeka. Department of Maritime Transportation), 2022.
- [6] Kolarovszki, P., Kolarovszká, Z., Perakovic, D., & Periša, M., "Laboratory testing of active and passive UHF RFID tags," *Transport and Telecommunication Journal*, 17(2), pp. 144-154, 2016.
- [7] Janičijević, P., & Avramović, Z., "Applying ICT in courier services," *Infoteh-Jahorina*, vol. 6, pp. 360-364, 2007.
- [8] Spalević, Ž., Ilić, M., & Palević, M., "Electronic Tracking Of Postal Services," *In Sinteza 2016-International Scientific Conference on ICT and E-Business Related Research*, 2016, pp. 479-485.
- [9] Iwan, S., Kijewska, K., & Lemke, J., "Analysis of parcel lockers' efficiency as the last mile delivery solution—the results of the research in Poland," *Transportation Research Procedia*, 12, pp. 644-655, 2016.
- [10] Prandstetter, M., Seragiotto, C., Braith, J., Eitler, S., Ennsner, B., Hauger, G., & Steinbauer, M., "On the impact of open parcel lockers on traffic," *Sustainability*, 13(2), pp. 755, 2021.

- [11] Lagorio, A., & Pinto, R., “The parcel locker location issues: An overview of factors affecting their location,” *In Interconnected Supply Chains in an Era of Innovation-Proceedings of the 8th International Conference on Information Systems, Logistics and Supply Chain, ILS*, 2020, pp. 414-421.
- [12] Yang, G., Huang, Y., Fu, Y., Huang, B., Sheng, S., Mao, L., & Yin, Q., “Parcel locker location based on a bilevel programming model,” *Mathematical Problems in Engineering*, 1-12, 2020.
- [13] Peppel, M., & Spinler, S., “The impact of optimal parcel locker locations on costs and the environment,” *International Journal of Physical Distribution & Logistics Management*, 52(4), pp. 323-350, 2022.
- [14] Giuffrida, M., Mangiaracina, R., Perego, A., & Tumino, A., “Home Delivery vs Parcel Lockers: an economic and environmental assessment,” *Proceedings of the 21th Summer School Francesco Turco, Naples, Italy*, 2016, pp. 13-15.
- [15] Seghezzi, A., Siragusa, C., & Mangiaracina, R., “Parcel lockers vs. home delivery: a model to compare last-mile delivery cost in urban and rural areas,” *International Journal of Physical Distribution & Logistics Management*. 52(3), 2022.
- [16] Schwerdfeger, S., & Boysen, N., “Optimizing the changing locations of mobile parcel lockers in last-mile distribution,” *European Journal of Operational Research*, 285(3), pp. 1077-1094, 2020.
- [17] Schwerdfeger, S., & Boysen, N., “Who moves the locker? A benchmark study of alternative mobile parcel locker concepts,” *Transportation Research Part C: Emerging Technologies*, 142, pp. 103780, 2022.
- [18] Lemke, J., Iwan, S., & Korczak, J., “Usability of the parcel lockers from the customer perspective—the research in Polish Cities,” *Transportation Research Procedia*, 16, pp. 272-287, 2016.
- [19] Wang, Y., Bi, M., Lai, J., & Chen, Y., “Locating movable parcel lockers under stochastic demands,” *Symmetry*, 12(12), pp. 2033, 2020.

# Smarty city with green last mail delivery

Estera Rakić<sup>1</sup>, Ivana Buzdovan<sup>1</sup>, Zoran Nedić<sup>2</sup>

<sup>1</sup>Faculty of transport, communications and logistics, Budva, Montenegro

<sup>2</sup>Montenegro Post, Podgorica, Montenegro

## Abstract

This paper explores the possibilities of organizing sustainable last-mile delivery in smart cities. A smart city is a place where traditional networks and services become more efficient by using digital solutions for the benefit of its residents and businesses. Delivering goods to residents is a significant challenge in smart cities. With the development of e-commerce, which has been further boosted by the COVID-19 pandemic, there has been an evident increase in shipments, which further stimulates the implementation of new solutions to develop green last-mile delivery while meeting the service quality needs of users. Montenegro is taken as a case study. Montenegro keeps pace with technological development and thus the need to define a strategy for the development of smart cities, which includes mobility. The basis for smart mobility is information and communication technologies that currently play a crucial role in mobility, and this paper focuses on a smaller segment of mobility that encompasses the synergy of ICT technologies and postal services to develop smart cities. The paper will focus on calculating the difference in harmful gas emissions by implementing parcel lockers in dense urban areas of Montenegro.

**Keywords:** last mile delivery, parcel lockers, Sustainable and smart delivery, smart city

## 1 Smart city

When we talk about a smart city, we come across a very large number of definitions. What is common to all definitions is that the application of information - communication technologies (ICT) and data processing serves as a mean of solving economic, social, and environmental challenges in the city. There are more sources of innovation and systems available in the world today than ever before. The development of 5G networks and data collection has opened up new opportunities for improving the quality of life. Using the overall progress of technology, especially ICT, as well as its constant improvements, the development of a smart city should provide relevant scenarios for the life of citizens with the necessary quality and simplicity in overcrowded urban environments. The development of smart cities is expected to improve economic growth and development to build a clean and sustainable

environment, increase income for all, provide support to the disadvantaged and make the management of city services more transparent.

### 1.1. Smart city – Montenegro

Geographical position, climate conditions and characteristics of its area, natural resources and their distribution make Montenegro an exceptional European country in many ways. Montenegro is on the path towards European integration and joining the European Union, but to keep up with developed European countries and direct development towards increasing the quality of life of citizens and the efficiency of state and local services, it is necessary to define a Smart City strategy. By implementing the Information Society Development Strategy, Smart Specialization Strategy, and Sustainable Development Strategy, significant progress is being made towards achieving these goals. However, to properly define the mission, vision,

---

Corresponding author: Estera Rakić (estera\_rakic@hotmail.com)

© 2023 The Author(s). This work is licensed under a Creative Commons Attribution 4.0 International License.

and goals of a smart city, it is necessary to incorporate this document with existing strategies and their objectives. The aspiration of a smart city is related to the transformation and improvement of the quality life of citizens, efficient management and development of local self-government, sustainable management of natural resources and energy. The pandemic that hit the world presented and accelerated the desire to preserve the environment, through the reduction of the use of pollutants, including motor vehicles. In the past three years, there has been a significant increase in last-mile delivery, as people increasingly bought products online and the ecosystem had a good and fast response to all requests, this trend is still present today to a large extent, with upgrades and constant improvements it will increase degree of sustainability, mobility as well as economic efficiency and thereby fulfil some of the main aspirations of a smart city.

### 1.1 Sustainable and Smart cities

Preservation of natural heritage is a big challenge for cities in the 2nd century. Sudden urbanization, the need for additional facilities, the increase in the movement of people and goods make it difficult to protect the natural wealth of cities. The smart and strategically oriented development of infrastructure as well as the application of new technologies can significantly mitigate the negative effects on the environment. Smart cities transform the environment into their infrastructure, enabling a better quality of life for the population in the cities and increasing the energy efficiency of the infrastructure [5].

## 2 Urban mobility

Urban mobility is one of the most relevant factors when the subject is sustainability. The Sustainable Urban Mobility Plan (SUMP) is a strategic plan that builds on existing planning practice and considers integration, participation, and evaluation principles in order to meet the mobility needs of city dwellers, now and in the future. and provided a better quality of life in cities and their surroundings. The goal of the Plan for Sustainable Mobility in Cities is to create a sustainable transport system in cities by:

- ensuring availability of jobs and services to everyone

- safety and security improvements
- reduction of pollution, emission of greenhouse gases and energy consumption
- increasing efficiency and economy in the transportation of people and goods
- increase in the attractiveness and quality of the urban environment.

### 2.1 Sustainable and smart mobility

The European Commission adopted the Sustainable and Smart Mobility Strategy - – putting European transport on track for the future in December 2020 [6]. This strategy laid the foundations for how the EU's transport system can achieve its green and digital. The strategy is structured around three key objectives: to make the European transport system sustainable, smart, and resilient.

(1) Sustainable mobility: A clear path is needed to achieve a 90% reduction in transport-related greenhouse gas emissions by 2050 to ensure that the EU becomes the first climate neutral continent by 2050 as called for by the European Green Plan. Today, transport accounts for a quarter of the total greenhouse gas emissions in the European Union.

Digital mobility: Digitization will become an indispensable driver for the modernization of the entire system, making it invisible and more efficient, while further reducing emissions. Europe also needs to use digitization and automation to further increase levels of safety, efficiency, reliability, and comfort, thus maintaining the European Union's leadership in transport equipment manufacturing and services and improving our global competitiveness. In this way, research, and testing before introduction through funding instruments such as Horizon Europe and the Connecting Europe Facility play a key role.

Resilient mobility: The coronavirus pandemic has shown how important our single market and the social, health and economic costs are when the free movement of people and goods is severely or even completely restricted. Preservation of supply chains and a coordinated European approach to connectivity and transport activities are key to overcoming any crisis and strengthening the strategic autonomy and resilience of the European Union. The goals are to direct the necessary investments in the recovery of infrastructure and

fleets to modernize and green the sector and to strengthen our single European market. Also, the elements that will be insisted on is a fair transition for users and workers, as well as the need for mobility to remain safe.

Specific goals set by the Strategy for 2030:

By 2030:

- at least 30 million zero-emission vehicles will be in operation on European roads.
- 100 European cities will be climate neutral.
- high-speed rail traffic will double.
- scheduled collective travel of under 500 km should be carbon neutral within the EU.
- automated mobility will be deployed at large scale.
- zero-emission vessels will become ready for market.

By 2035.:

- zero-emission large aircraft will become ready for market.

2050.:

- nearly all cars, vans, buses as well as new heavy-duty vehicles will be zero emission.
- rail freight traffic will double.
- high-speed rail traffic will triple.
- the multimodal Trans-European Transport Network (TEN-T) equipped for sustainable and smart transport with high-speed connectivity will be operational for the comprehensive network.

Given that postal traffic and delivery (last mail delivery) of parcels is an integral part of traffic primarily by road (because most parcels at the European level are transported by road, it is necessary to harmonize the strategy of the development of postal activity with the Strategy for sustainable and smart mobility. Therefore, one of important topics of smart city organizing sustainable processes of urban logistics last-mile logistics (micro-level) The key challenges faced by the organizers of last-mail delivery in urban areas are the following:

1. Increased urbanization (restrictions to mobility in most urban areas)
2. Booming in e-commerce (problems in capacity)

3. Changing customer expectations (demand for a short delivery time, high service quality, and more free shipping)

4. Rising debates over environmental issues (more conscious city actors toward CO2 emissions, noise pollution, and visual intrusion)

5. Impact on traffic congestion (the high number of delivery vehicles on the road)

6. Deficiencies in urban planning for logistics operations (lack of loading and unloading space in inner-urban areas)

7. High delivery cost per parcel (inefficiencies in operations especially for last-mile delivery)

8. Rising trends through multi-channel distribution (a need for adding value-added business models)

### 3 Sustainable last mail delivery postal items

The postal sector is committed to serving its customers while mitigating its environmental and social impacts worldwide. As operators of over half a million vehicles, thousands of buildings, and employing a workforce of more than 1.3 million, posts have considerable opportunities to make positive contributions to both people and the planet.

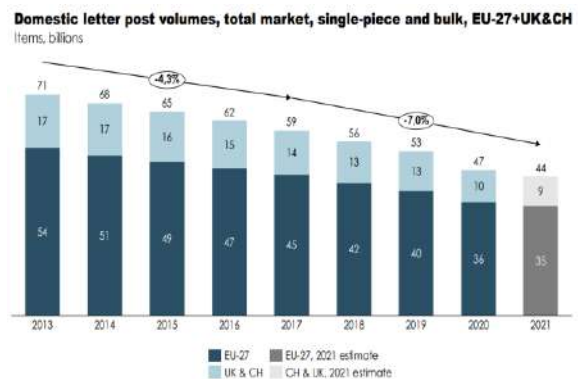
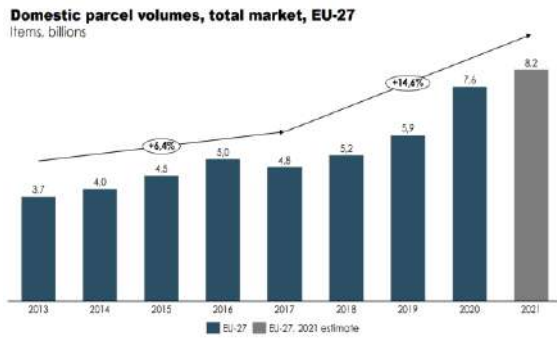

Fig. 1: Domestic letter post volumes, total market, single-piece and bulk - EU countries [7]

Changes in the product structure [Fig.1, Fig.2], less letters increase parcels, create challenges for postal operators to reduce their environmental footprint.



**Fig. 2.:** Domestic parcel volumes, total market – EU countries [7]

Postal operators’ product mix is changing – the relative importance of parcel delivery is increasing. This has important implications for postal operators’ environmental footprint because parcel delivery requires significantly more logistical and transportation capacity than letters. The carbon emissions per parcel are greater than the carbon emissions per letter.

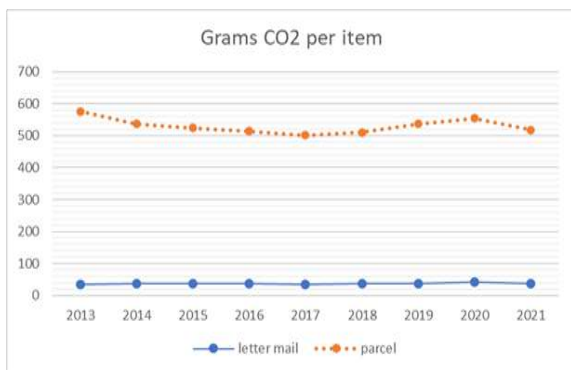

**Fig 3:** CO2 emissions from parcel and letter delivery 2013–2021 [8]

Postal operators will focus mainly on emissions generated by buildings and transportation, which respectively account for 45 and 55% of their total emissions. By 2030, posts collectively aim to have 50% of their fleet as alternative fuel vehicles (against 22% in 2020), of which 25% of electric vehicles (against 16% in 2020) and 75% of their energy consumed, generated from renewable sources (against 33% in 2020) [7]. In line with their alignment with the UN Sustainability Development goals, postal commitment also goes beyond CO2 emissions. By 2030, they collectively commit to have 50% of sold packaging reusable, recyclable, or compostable. Environmental Measurement and Monitoring System covers seven categories which relate to five SDGs where posts could have the most positive impact. These include Health and Safety,

Learning and Development, Resource Efficiency, Air Quality, Circular Economy, Sustainable Procurement and Climate Change.

According to the data, it is evident that there is an increase in CO2 emissions per package, which is due to several reasons:

- The packages are larger in size, hence the number of packages that fit in a vehicle is reduced.
- An increasing number of users are ordering online, which leads to a higher number of stops for individual package deliveries.
- A significant number of packages still cannot be delivered on the first attempt (for Montenegro, the number of packages that are successfully delivered on the first attempt is between 80-90%).

### 3.1 The impact of green delivery on CO2 emissions

One way to reduce CO2 emissions in urban areas is to install parcel lockers for last mail delivery. Parcel lockers are one of the options that postal operators use to optimize processes and reduce CO2 emissions. To make parcel lockers contribute to reducing CO2 emissions, attention needs to be paid to their location, as otherwise, they could further stimulate CO2 emissions. However, for parcel lockers to be acceptable as a CO2 reduction element, it is also important that users who come to the parcel locker point use environmentally friendly means (by walking or cycling) [9]. Analysis of previous studies has determined an acceptable distance for walking. As shown in Figure 4 - the function for the transportation mode of walking drops the fastest, given the maximum value of the distance that people are willing to walk (up to 1km). This approach can also be applied to determine the location of parcel lockers in urban areas. The distance to the parcel locker up to 1 km [10] is acceptable for users to walk.

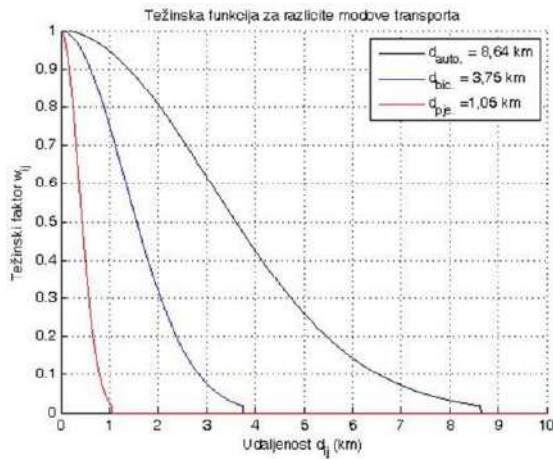

**Fig 4:** Representation of weight values in different transportation modes [10]

It can be concluded that if the distance from the user to the parcel locker is greater than 1 km, there is a high probability that the user would not walk to the locker as a mode of transportation from home to the locker, but instead use another mode of transportation (bike, public transport, or personal vehicle). According to research [11], the acceptable distance for users to walk to a Parcel Locker is 700 meters, or 3 minutes. Since we are considering a smaller urban environment, we observed a potential distance of up to 800 meters. If a user were to use a personal vehicle as a mode of transportation in these cases, the CO<sub>2</sub> emissions would be multiplied compared to the CO<sub>2</sub> emissions that the postal service provider would produce if they attempted to deliver to the user's home [9].

In conclusion, parcel lockers as points of collection or delivery in smart cities can contribute to reducing CO<sub>2</sub> emissions if located at appropriate locations.

### 3.2 An example of a smart city organization with green delivery in Montenegro

For this paper, an analysis of express mail delivery by Montenegro Post in the city of Budva was conducted. Budva is a densely populated urban area with a total population of 10,918 [12] residents living in an area of approximately 4.2 square kilometres.

In addition, the criterion for determining the required number of parcel lockers was used as an additional tool [13]. The criterion states that the universal postal service operator provides a

network of public postal services such that one branch operates on average:

- in an area of up to 100 km<sup>2</sup> or
- for up to 5000 residents.

Therefore, we used the same criterion for determining the number of parcel lockers as for determining the number of postal services. Based on this criterion, we concluded that two parcel lockers were sufficient for the number of residents.

An additional task was to determine their locations. The Location Set Covering Problem (LSCP) model was used to define the locations of the parcel lockers. The Location Set Covering Problem is described by Toregas et al. (1971). Therefore the LSCP model was proposed whereby *the minimum number of facilities determined and locaten so that every demand area is covered within a predefined maximal service distance or time (Church and Murray, 2018) [14]*

The set covering location problem (SCLP) can be formulated as:

$$\text{Minimize } \sum_{j \in J} Y_j \quad (1)$$

$$\text{Subject to: } \sum_{j \in N_i} Y_j \geq 1 \quad \forall i \in I \quad (2)$$

$$Y_j \in 0,1 \quad \forall j \in J \quad (3)$$

Where:

$i$  = index of demand points/areas/objects in set I

$j$  = index of potential facility sites in set J

$S$  – maximal acceptable service distance or time standard

$d_{ij}$  – shortest distance between nodes I and j

$N_i = \{j \mid d_{ij} \leq S\}$  - the set of all candidate locations that can cover demand point i and the following decision variable

$$Y_j = \begin{cases} 1, & \text{if a facility is located at mode } j \\ 0, & \text{otherwise} \end{cases}$$

Determining the location in our example of a parcel locker represents solving specific location

problems for covering customers. It is often used in determining locations for emergency services such as police and fire stations, ambulances, but it is also encountered in literature as a method for determining the location of post offices [16]. They must cover as many people as possible while keeping servicing costs as low as possible.

In practice, the costs of serving a client are usually directly proportional to the distance between the client and the facilities. However, in this study, we track the CO2 emissions per parcel in the last mile phase in urban environments - the city of Budva. The primary objective of this study was to select locations for service facilities so that as many potential clients as possible would be covered. Many models of this problem have been defined and solved, but one of the most important is the maximal covering location problem (MCLP).

To determine the location of parcel lockers, we used criteria established in [10], according to which the expected distance that a user would walk without using any means of transportation is up to 1 km. In this way, we divided the city of Budva into 12 squares, each with a diagonal of 800m. In this way, we obtained 20 potential points for the location of parcel lockers (Fig 5), based on which we observed the distances between points that users would walk in case the distance was up to 1 km.

We eliminated points on the outskirts of the city where there are no residential buildings (points 1,2,4,5,13,15,16,17, 19, and 20). In the next step, we obtained a 20 x 20 matrix - the columns with the highest sum represent a potential location for placing parcel lockers.

**Table 1:** Covering matrix

	1	2	3	4	5	6	7	8	9	10	11	12	13	14	15	16	17	18	19	20
1	0	0	0	0	0	0	0	0	0	0	0	0	0	0	0	0	0	0	0	0
2	0	0	0	0	0	0	0	0	0	0	0	0	0	0	0	0	0	0	0	0
3	0	0	1	0	0	1	1	1	0	0	0	0	0	0	0	0	0	0	0	0
4	0	0	0	0	0	0	0	0	0	0	0	0	0	0	0	0	0	0	0	0
5	0	0	0	0	0	0	0	0	0	0	0	0	0	0	0	0	0	0	0	0
6	0	0	1	0	0	1	1	0	1	1	1	0	0	0	0	0	0	0	0	0
7	0	0	1	0	0	1	1	1	0	1	1	1	0	0	0	0	0	0	0	0
8	0	0	1	0	0	0	1	1	0	0	1	1	0	0	0	0	0	0	0	0
9	0	0	0	0	0	1	0	0	1	1	0	0	0	1	0	0	0	0	0	0
10	0	0	0	0	0	1	1	0	0	1	1	0	0	1	0	0	0	0	0	0
11	0	0	0	0	0	1	1	1	0	1	1	1	0	1	0	0	0	0	0	0
12	0	0	0	0	0	0	1	1	0	0	1	1	0	0	0	0	0	0	0	0
13	0	0	0	0	0	0	0	0	0	0	0	0	0	0	0	0	0	0	0	0
14	0	0	0	0	0	0	0	0	1	1	1	0	0	1	0	0	0	0	0	0
15	0	0	0	0	0	0	0	0	0	0	0	0	0	0	0	0	0	0	0	0
16	0	0	0	0	0	0	0	0	0	0	0	0	0	0	0	0	0	0	0	0
17	0	0	0	0	0	0	0	0	0	0	0	0	0	0	0	0	0	0	0	0
18	0	0	0	0	0	0	0	0	0	0	0	0	0	0	0	0	0	0	1	0
19	0	0	0	0	0	0	0	0	0	0	0	0	0	0	0	0	0	0	0	0
20	0	0	0	0	0	0	0	0	0	0	0	0	0	0	0	0	0	0	0	0
	7	0	0	4	0	0	6	7	5	3	6	7	4	0	5	0	0	0	1	0

The following step resulted in obtaining two key points for the location of the parcel machines:

**the first point** - point 14 in the city centre (where banks, restaurants, and the beach, as well

as the main post office, are located),

**the second point** is point 7 in the dense residential area of the Babilonija settlement.

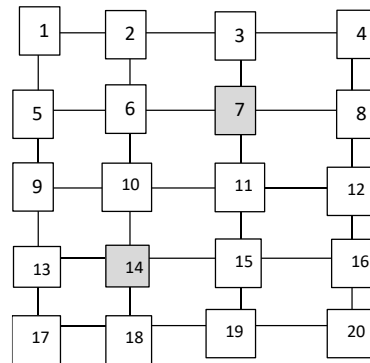

**Fig 5:** Nodes-candidates for the parcel locker

A potential point of consideration was also point 11, however, considering that there is already a post office at point 14, and the goal is to reduce CO2 emissions, by choosing to point 14 as the location for the parcel machine, we achieved greater savings in reducing CO2 emissions.

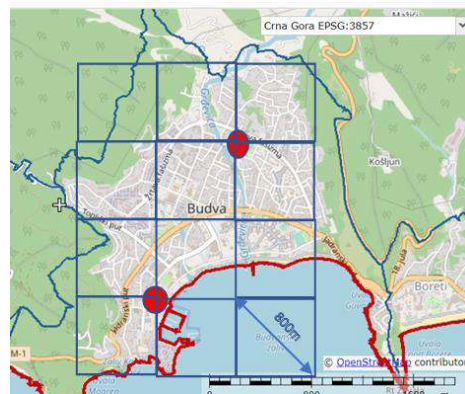

**Fig. 6:** Proposed location for a parcel locker in the city of Budva

## 4 Conclusion

By analysing data from the Montenegro Post about package delivery in the city of Budva, it was determined that the vehicle delivering packages in the city of Budva on average travels 45km per day. If package delivery were to be carried out exclusively via the mentioned 2 package stations, then the express delivery vehicle would cover between 1.5 km – 2 km per day (depending on traffic density primarily in summer months). In this paper, the SCLP method is presented as an effective tool that can be used for scheduling parcel lockers and access points as presented in [16].



Emissions from transport account for one quarter of the EU's greenhouse gas emissions. To achieve climate neutrality, the European Green Deal calls for a 90% reduction in greenhouse gas emissions from transport by 2050 (EEA, 2019). Regulation (EU) 2019/631 (EU, 2019) sets a fleet-wide target of 147g CO<sub>2</sub>/km for the years 2020-2024, and stricter fleet-wide targets for 2025 and 2030. Following a steady decline between 2012 and 2017 and a slight increase between 2017 and 2019, 2020 saw average specific CO<sub>2</sub> emissions of newly registered light commercial vehicles fall to 155.0g CO<sub>2</sub>/km – a 2% decrease in comparison to 2019.

For the purposes of this paper, the average emissions of a delivery vehicle of 150g CO<sub>2</sub>/km were considered. If we were to analyse CO<sub>2</sub> savings in the example of the city of Budva, for last mile delivery of packages through package machines - over the course of one year, it would amount to 1.7T CO<sub>2</sub>, if all citizens would come to collect their packages on foot or would not travel additional kilometres to retrieve their shipment. In this way, a 95% reduction in CO<sub>2</sub> emissions per package for the last mile delivery would be achieved compared to the current method of last mile package delivery in the city of Budva.

## References

- [1] COMMUNICATION FROM THE COMMISSION TO THE EUROPEAN PARLIAMENT, THE EUROPEAN COUNCIL, THE COUNCIL, THE EUROPEAN ECONOMIC AND SOCIAL COMMITTEE AND THE COMMITTEE OF THE REGIONS The European Green Deal, COM/2019/640 final <https://eur-lex.europa.eu/legal-content/EN/TXT/?uri=CELEX:52019DC0640>
- [2] “Strategic Plan 2020-2024”, DG ENVIRONMENT, European Commission [https://commission.europa.eu/system/files/2020-10/env\\_sp\\_2020\\_2024\\_en.pdf](https://commission.europa.eu/system/files/2020-10/env_sp_2020_2024_en.pdf)
- [3] “Regulation (EU) 2021/1119 of the European Parliament and of the Council of 30 June 2021 establishing the framework for achieving climate neutrality and amending Regulations (EC) No 401/2009 and (EU) 2018/1999 (‘European Climate Law’), <https://eur-lex.europa.eu/legal-content/EN/TXT/?uri=celex%3A32021R1119>
- [4] Smart cities index report 2022, *The Digital Transformation Technology Management Center*
- [5] Smarter Cities 2025 Building a sustainable business and financing plan, ESI ThoughtLab
- [6] COMMUNICATION FROM THE COMMISSION TO THE EUROPEAN PARLIAMENT, THE COUNCIL, THE EUROPEAN ECONOMIC AND SOCIAL COMMITTEE AND THE COMMITTEE OF THE REGIONS Sustainable and Smart Mobility Strategy – putting European transport on track for the future, COM/2020/789 <https://eur-lex.europa.eu/legal-content/EN/TXT/?uri=COM%3A2022%3A230%3AFIN>
- [7] M. Cerpickis, A. Möller Boivie, S. Tizik, S. Spahn, M. Lahann, N. Gallagher, J. Wahl, B. Basalisco, H. Ballebye Okholm, „Main developments in the postal sector (2017-2021)“, Copenhagen Economics, Study for the European Commission, Directorate General for Internal Market, Industry, Entrepreneurship, and SMEs, 2022
- [8] <https://www.ipc.be>
- [9] J. Wolff, A. Labinsky, S. Eckert, K. Esser, “Study to assess and analyse the impact of e-commerce driven transport and parcel delivery on air pollution and CO<sub>2</sub> emissions” Study for the European Commission, Directorate General for Internal Market, Industry, Entrepreneurship, and SMEs, 2022
- [10] K. Mostarac, “Determining universal postal service accessibility in postal system by applying transport connectivity criterion”, doctoral thesis, Faculty of Transport and Traffic Sciences 2017
- [11] K. Hofer, S. Flucher, M. Fellendorf, M. Schadler, N. Hafner, “Estimation of Changes in Customer’s Mobility Behaviour by the Use of Parcel Lockers”, 22nd EURO Working Group on Transportation Meeting, EWGT 2019, 18-20 September 2019, Barcelona, Spain
- [12] <https://hr.wikipedia.org/wiki/Budva>
- [13] Pravilnik o bližim uslovima za obavljanje univerzalne poštanske usluge, Službeni list Crne

Gore, br. 029/17 od 05.05.2017, 114/20 od 30.11.2020

- [14] R. L. Church, A.T. Murray, "Location covering models", History, applications and advancements (1st edition 2018). Springer
- [14] C. Toregas, R. Swain, C. ReVelle, "The location of emergency service facilities", *Operations Research*, 19(6), 1363–1373
- [15] Zacharias J. Pedestrian "Behavior and Perception in Urban Walking Environments". *Journal of Planning Literature*. 2001;16(1):3-18.
- [16] D. Šarac, M. Kopic, K. Mostarac, M. Kujačić, B. Jovanović "Application of Set Covering Location Problem for Organizing the Public Postal Network", *Promet – Traffic&Transportation*, Vol. 28, 2016, No. 4, 403-413
- [17] S. Schwerdfeger, N. Boysen, „Who moves the locker? A benchmark study of alternative mobile parcel locker concepts“, *Transportation Research Part C: Emerging Technologies Volume 142*, September 2022, 103780
- [18] V. Bonomi, R. Mansini, R. Zanotti, "Last Mile Delivery with Parcel Lockers: evaluating the environmental impact of eco-conscious consumer behavior" *IFAC-PapersOnLine Volume 55, Issue 5, 2022, Pages 72-77*
- [19] C. Weissa, U. Onnen-Webera, "The challenge of sustainable last mile distribution of CEP services in small towns" *Transportation Research Procedia* 39 (2019) 597–604
- [20] J.H.R. van Duina,b, B.W. Wiegmansc, B. van Aremc, Y. van Amstel, "From home delivery to parcel lockers: a case study in Amsterdam" *Transportation Research Procedia* 46 (2020) 37–44

# The Sustainability of Urban Postal Logistics and the AR Technology

Slavica Radosavljević, Biljana Grgurović, Jelena Milutinović, Stevan Veličković

Department School of Information and Communication Technologies, Academy of Technical and Art Applied Studies, Z. Celara 16, Belgrade 11000, Serbia

## Abstract

Sustainable urban logistics encompasses a rational movement of goods via various modes of transport, as well as the management of warehouses, warehouse complexes, and delivery networks. Urban postal logistics is becoming gradually more important as the urban population and e-commerce are increasing. Efficient and sustainable delivery management in narrower city cores is important for the alleviation of traffic congestion, air pollution, and carbon emissions. In addition, it plays a crucial role in enabling fast and reliable delivery of goods to end users and companies. Some key challenges in urban logistics include limited room for warehousing and distribution, traffic congestion, pollution, noise, and gradually shorter expected delivery times. To tackle all these challenges, urban logistic solutions can include alternative transportation options, route and delivery optimization, as well as the application of smart technologies and data analysis. AR (augmented reality) has the potential to make postal-logistic operations more efficient, economical, and safer through the use of real-time data, visualization, and remote assistance. On the road to sustainability, the visualization of operations can be especially useful. This allows logistics managers to better understand the flow of goods and make timely decisions. Equally important is the education of personnel through simulations of technological processes or their parts, and remote assistance, which can engage users through an interactive experience and improve customer satisfaction through a 3D representation of goods in their environment.

**Keywords:** *urban postal logistics, augmented reality, logistic*

## 1 Introduction

More than 73% of the European population lives in urban environments, and this number is expected to rise to 85% by 2050 [1]. This urbanization phenomenon has resulted in an increasing demand for city transport, both for B2B and B2C purposes.

Consequently, one of the problems operators face is that of more efficient distribution in cities in terms of sustainable mobility policies. As a consequence, the problems facing postal-logistic operators is the question of efficient distribution of goods in cities in the context of sustainable mobility policies.

Accordingly, these operators continually work on innovative delivery methods, from various types of pickup stations to using drones.

Unfortunately, customers usually aren't concerned with the delivery method. They put a focus on receiving the ordered article as quickly and cheaply as possible, in perfect condition, at their address.

This attitude can be altered by raising awareness of the importance of innovative methods and their impact on the environment. This can be done through education, awareness campaigns, or financial stimuli.

In [2], urban mobility is defined as sustainable mobility in the socio-economic context of the urban area that can be seen through actions on land use and occupation and on transport management, aiming to provide access to goods and services in an efficient way for all inhabitants, and thus maintaining or improving the quality of

---

<sup>1</sup>Corresponding author: *Slavica Radosavljevic (slavica.radosavljevic@ict.edu.rs)*

© 2023 The Author(s). This work is licensed under a Creative Commons Attribution 4.0 International License.

life of the current population without harming the future generation.

Sustainable urban mobility includes transportation systems and infrastructure designed to minimize negative ecological, social, and economic impacts tied to urban transportation. This includes the promotion of alternative modes of transport for certain distances, such as walking, cycling, and public transit. It also encompasses designing cities and transport networks in a way that will reduce the need for personal vehicles.

Paulraj and Chen in [3] state that the use of information technology in logistics has positively influenced the flexibility, speed of operations, delivery processes, and responsiveness. These are all critical dimensions of effective logistics operations.

## **2 Applying AR to Urban Mobility**

AR is one of the technologies that enable Industry 4.0 [4]. Currently, various devices support AR technology, enabling users to see virtual objects and communicate with them in the real world. They can be divided into three categories: headsets, such as smart glasses, handheld devices, such as smartphones and tablets, and spatial devices, such as projectors.

Augmented reality has the potential to change urban mobility at its core. Various applications of the technology offer users a safer and more efficient movement through the city. They do this by providing relevant and necessary information about their environment in real time.

The simplest way to apply AR technology to urban mobility is during driver training in order to raise awareness about their surroundings and improve safety. With AR headsets, drivers can see virtual information which would help them find their way and avoid potential dangers. For instance, the AR system could display speed limits, traffic jams, road conditions, and other factors that affect driving.

AR provides information about nearby stores, restaurants, and attractions, as well as traffic, weather, and other factors that affect the user's movement.

In public transit, AR provides information on bus and train schedules, delays, and route changes, increasing the efficiency of the service.

This would directly reduce the number of personal vehicles on the roads and, consequently, reduce gas emissions and the greenhouse effect. AR applications can provide travelers with information concerning bus and tram schedules, location, and routes to take to get to their destination most efficiently. Additionally, AR can help users navigate complex transit stations and nodes.

One of the most perspective applications of AR in urban mobility is navigation. By overlaying digital and real-world, AR can provide users with detailed directions, points of interest, and more. This way, users don't have to use a map or a GPS device.

Adjusting the use of AR technology to contemporary sustainability conditions in logistics allows for combining multiple modes of transport. Using AR, drivers and passengers can track and exchange information on traffic and travel times. This can further help them choose the best route and mode of transport.

## **3 Usage of AR by Postal-Logistic Operators**

Faced with the many problems that affect their operations in urban environments, operators should have no issue accepting AR technology. That is, the transition to an alternative organizational model for delivery and routing based primarily on AR should be smooth. This model comprises interactions between real-world points or interactive graphic systems that produce an enriched image by overlaying information, including virtual elements, multimedia, or simple data.

The application of AR in postal-logistic systems includes support in tasks that rely on the current approach and a clear insight into relevant information. In [5] analyzing the scientific literature, the main logistic points where AR should be applied include warehouses, transportation, and training.

### **3.1 Warehouses**

There are many aspects of warehouse operations that could be optimized using AR. This includes information on unloading points, the arrangement of goods, or assigned tasks. The AR device could also display the package and the

packaging process. The goal behind all of this is a more efficient use of time and space.

### **3.2 Transportation**

In recent years, the development of e-commerce has significantly increased the number of transportation routes, and it dictates their organization. Logistics providers, regardless of financial gain, must navigate highly complex route organization and management. When the goods are sent, AR can shorten latencies by providing up-to-date, real-time traffic data and information on optimal routes. In case of traffic jams, the AR system enables the visualization of less encumbered routes and directs the driver to the right lane. The advantage of this technology is that the driver can either wear a headset or directly see this information projected on the windshield.

### **3.3 Education (training)**

AR can be widely applied in the training phase, as it enables intuitive learning on how to solve a certain logistics task. In the Logistics 4.0 environment, it is crucial that the employees constantly receive training. That way, they are able to use new technological components and carry out tasks with minimal room for error. AR offers a good solution, providing visual direction in real time and training employees for fieldwork. The entire supply chain, from logistics to warehouse pickup, is explained on the spot, step-by-step, through a practical, interactive guide. AR enables the overlay of useful information on the object the trainees must interact with, thus helping them carry out the tasks.

### **3.4 Improvements Made Through the Application of AR**

As object manipulation in logistics calls for extensive use of one's hands, the most applicable AR category, in this case, is headset devices. Based on [6], the application of these devices would, above all, improve visualization, interaction, benefits for the consumer, and navigation.

#### **3.4.1 Improvements in Visualization**

The virtualization of organizational activities necessitates an improvement in the visualization

of real-life processes. This is important for a better understanding of the work environment and a faster identification of possible solutions for various logistical problems. AR smart glasses enable increased speed and flexibility compared to existing solutions. This is primarily done through the elimination of unnecessary movements and the minimization of time spent searching for necessary information. The authors in [7] state that, while the operator receives orders, AR glasses display certain information. This information reduces the time necessary for the task by eliminating excessive movements of the head and body. One example of an application is when the barcode reader makes it difficult to handle bulky goods with both hands. Here, using AR technology ensures that the operator's hands are completely free, allowing them to pick up objects more comfortably (DHL). In addition, in [8] the application of smart glasses in the search for specific articles on shelves has increased flexibility and reduced response. There are well-known examples demonstrating that smart glasses ensure safe and efficient task completion in the workplace. They also provide a larger amount of data that prevents accidents during activities and movements (Epson's Moverio BT-350 ANSI Edition, designed for industrial applications, has built-in safety features that warn workers of hazardous conditions). Thus, the visualization enabled by smart glasses leads to higher control and sustainability in logistics and the SCM environment. It also increases workplace safety and efficiency.

#### **3.4.2 Improvements in Interaction**

Improved interaction of modern business operations (Industry 4.0) includes sophisticated production and warehouse environments that are interoperable and can communicate with people, machines, and products [9]. Smart glasses can provide real-time notifications of upcoming maintenance tasks. Schneider Electric utilizes smart glasses to give technicians real-time access to maintenance data and schedules, ensuring proper upkeep of equipment.

AR, above all, brings the ability to interact with objects in real time. Modern displays, including smart glasses, have the ability to improve the interaction between people and their environment. This increases human perception while completing tasks. A good example of this is Google Glass, which allows employees to take

photographs and videos by using the touchscreen or voice commands.

One of the improvements to interaction is the drowsiness and fatigue detection system based on wearable smart glasses designed to improve road safety. The suggested system in [10] can survey the driver's status in terms of drowsiness and fatigue in real time. It does this using a miniature infrared (IR) sensory transceiver attached to the glasses. The transceiver continuously scans the driver's eyelids for signs of fatigue and warns them. This system helps the user avoid dangerous situations by providing detailed information in real time related to the risk of fatigue. Besides the abovementioned improvements in visualization, smart glasses can reduce errors and speed up logistical processes through a dynamic information flow and interactive communication.

### **3.4.3 Benefits for the Consumer**

Academic literature often notes simplicity of use as the main benefit for the consumer. This is one of the widely-used parameters for determining the degree of adoption of this technology. AR technology in logistics should be as efficient and comfortable as possible. Unlike tablets and smartphones, which can distract the user, [11] reported that smart glasses display information in a hands-free mode. This allows the user to safely carry out other tasks. This functionality makes smart glasses more practical and varied than traditional mobile devices and portable screens. With hands-free access to computer-generated content, such as routing information, employees can avoid having to carry hand-held scanners or paperwork as shown in [12].

### **3.4.4. Improvements in Navigation**

The application of sophisticated navigation tools is in accordance with the new concepts of Industry 4.0. With the advances of VR and AR, shown in [13], smart glasses are making navigation in various logistical settings easier. They constantly provide employees and operators with information regarding their environment to enable easier navigation with optimal routes. AR navigation proposed for cars allows the user to be free from additional information sources. This is achieved by embedding the operating equipment into the user's environment, that is, the vehicle.

Precise positioning for navigation in closed spaces and the ability of smart glasses to precisely determine locations are suitable for logistical environments. Smart glasses can be applied to order commissioning and warehouse pickup, even in larger warehouses and factories. Navigation through smart glasses, thus, has the potential to be more efficient than using conventional practices of order pickups. Given that orders can contain various products in various amounts, according to [14] the AR technology can provide operators with a reduction in cognitive load with real-time information in an industrial environment.

Smart glasses are paving the way for more intelligent navigational mechanisms with timely directions, improved navigation, and more precise localization. Rejeb et al. [6] indicate that they represent the next generation of navigation assistants, as they increase the area of view and support dynamical situational awareness. This leaves more space for multitasking, positioning, and orientation.

There are some deficiencies that have thus far been identified through technical challenges. This includes a limited field of vision, problematic lighting, hardware limitations, device weight, heat generation, and other design-related issues. Organizational challenges are a result of a different kind of problems. This includes user inexperience, resistance to new technologies, privacy and budget considerations, and the necessary changes to the existing infrastructure. Ergonomic challenges include, for example, making smart glasses compatible with regular glasses or balancing the weight of the device.

## **3.5 Conclusion**

AR brings numerous benefits and improvements to the area of logistics owing to the cognitive support for employees. It provides the right information at the right time and through the right medium. This reduces issues with high expenses, errors, low efficiency, and extensive use of paper in the process of warehouse management. Similarly, high expenses, long waiting times, and poor coordination in transportation management can be alleviated by improving safety and support for operators and reducing latencies.

Clearly, the use of AR in urban mobility can make life in cities more convenient, efficient, and pleasant. However, this requires simple, user-

friendly AR technologies and their integration into the existing urban infrastructure and transportation systems.

## References

[1] G. Aifandopoulou and E. Xenou, "Sustainable Urban Logistics Planning," European Platform on Sustainable Urban Mobility Plans, HORIZON 2020, 2019.

[2] V. B. G. Campos, "Uma visão da mobilidade sustentável," [Online]. Available: [http://www.ime.eb.br/~webde2/prof/vania/pubs/\(3\)UMAVISAODAMOBILIDADE.pdf](http://www.ime.eb.br/~webde2/prof/vania/pubs/(3)UMAVISAODAMOBILIDADE.pdf). [Accessed: 28-Mar-2023].

[3] A. Paulraj and I. J. Chen, "Strategic Buyer–Supplier Relationships, Information Technology and External Logistics Integration," *Journal of Supply Chain Management*, vol. 43, no. 2, pp. 2–14, 2007, doi: 10.1111/j.1745-493X.2007.00027.x.

[4] E. Oztemel and S. Gursev, "Literature review of Industry 4.0 and related technologies," *Journal of Intelligent Manufacturing*, vol. 31, no. 1, pp. 127–182, 2020.

[5] A. Lagorio et al., "Augmented reality in logistics 4.0: Implications for the human work," *IFAC-PapersOnLine*, vol. 55, no. 10, pp. 329–334, 2022, doi: 10.1016/j.ifacol.2022.09.408.

[6] A. Rejeb et al., "Potentials and challenges of augmented reality smart glasses in logistics and Supply Chain Management: A systematic literature review," *International Journal of Production Research*, vol. 59, no. 12, pp. 3747–3776, 2021, doi: 10.1080/00207543.2021.1876942.

[7] N. Murauer and N. Pflanz, "A Full Shift Field Study to Evaluate User-and Process-Oriented Aspects of Smart Glasses in Automotive Order Picking Processes," *Interaction Design & Architecture (s)*, no. 38, pp. 64–82, 2018.

[8] O. Blanco-Novoa et al., "A practical evaluation of commercial industrial augmented reality systems in an industry 4.0 shipyard," *IEEE Access*, vol. 6, pp. 8201–8218, 2018, doi: 10.1109/access.2018.2802699.

[9] J. de Vries, R. de Koster, and D. Stam, "Exploring the role of picker personality in predicting picking performance with pick by

voice, pick to light and RF-terminal picking," *International Journal of Production Research*, vol. 54, no. 8, pp. 2260–2274, 2015, doi: 10.1080/00207543.2015.1064184.

[10] T. Ruppert, S. Jaskó, T. Holczinger, and J. Abonyi, "Enabling Technologies for Operator 4.0: A Survey," *Applied Sciences*, vol. 8, no. 9, p. 1650, 2018, doi: 10.3390/app8091650.

[11] P. Fraga-Lamas, T. M. Fernández-Caramés, Ó Blanco-Novoa, and M. A. Vilar-Montesinos, "A Review on Industrial Augmented Reality Systems for the Industry 4.0 Shipyard," *IEEE Access*, vol. 6, pp. 13358–13375, 2018, doi: 10.1109/ACCESS.2018.2808326.

[12] H. Vujica, N. B. Buchmeister, A. Beharic, and B. Gajsek, "Visual and Optometric Issues with Smart Glasses in Industry 4.0 Working Environment," *Advances in Production Engineering & Management*, vol. 13, no. 4, pp. 417–428, 2018, doi: 10.14743/apem2018.4.300.

[13] M. K. Sharma and S. Chachaundiya, "Augmented reality navigation," *International Journal of Engineering Research and*, vol. 9, no. 06, 2020, available at: <https://doi.org/10.17577/ijertv9is060441>.

[14] C.-H. Tsai and J.-Y. Huang, "Augmented reality display based on User Behavior," *Computer Standards & Interfaces*, vol. 55, pp. 171–181, 2018, doi: 10.1016/j.csi.2017.08.003.

# Tram-train system approval procedure

Nermin Čabrić, Nedžad Branković, Aida Kalem

*University of Sarajevo, Faculty of Traffic and Communications, Bosnia and Herzegovina*

## Abstract

Tram-train is a type of light rail vehicle that meets the standards of a light rail system, usually a city tram, but that also meets national mainline standards, which allow it to operate alongside mainline trains. A tram-train can be a viable solution as it can integrate features of rail and tram systems using specially adapted light rail vehicles. When the tram-train system as a public transport concept enabling the combined development of transport on both light rail and heavy rail infrastructure use railway infrastructure, compliance with all essential requirements should be ensured, as well as compliance with the expected level of safety on the relevant lines using two different networks and mixing heavy rail and tram operations increase complexity and often require compromise solutions. The procedure, based on risk analysis, compliance check, and approval of the tram-train system, is presented in this paper. Transit networks based on the light rail can be a good option that aims to reduce the negative effects of individual mobility following the principles of sustainability.

**Keywords:** *Tram-train, Risk analysis, System approval, Sustainability*

## 1 Introduction

To address the need for enhanced mobility in urban areas, a new transportation system called the tram-train was developed in Europe during the 1990s. The tram - train is a public transport system, which originated in Germany, based on light rail vehicles and rail/tram infrastructure, capable of continuous operation outside and inside the city without passenger transfers [1]. The tram-train concept refers to a type of light rail vehicle that functions as a tram when operating on tramway or non-mainline railway systems, but also as a train on heavy rail mainline railway infrastructure. This type of transportation mode provides passengers with a smooth and uninterrupted journey from suburban areas all the way into the urban center of a city. The tram-train concept consists of the operation of light rail vehicles that can run on either existing or new tram lines, or existing railway lines, so that urban public transport services can be extended to the region over those lines, at a much lower cost than if they were built a completely new line [2]. Also, transit systems based on light rail could be a strategic alternative to decrease individual motorized transportation and promote sustainable

travel habits. These systems operate on principles of sustainability, efficiency, effectiveness, and quality.

Trams are integrated into the city's roadways, using specialized track infrastructure. The tram-train is a type of light rail vehicle (LRV) that has been adapted or modified for use on both tramway and railway tracks. Light rail transit (LRT) is, by design and operating characteristics, a system somewhere between a tram and a metro. Light rail transit and trams fall under the category of "Light Rail Vehicles" (LRVs) or "Light Rail Transit systems" (LRTs).

Fast urban transit services are provided on certain routes between stations where electric trains typically operate on railway tracks. Stations usually have high platforms which require trains to allow for safe passenger entry and exit, and to minimize differences in height between the train's entrance platform and the station platform. Urban transport systems are closed systems and are often functionally separated from one another. It may happen that a fast urban transport system that uses conventional railway tracks goes onto the public network, and in that case special provisions are applied when approving mobile means of

---

Corresponding author: *Aida Kalem (aida.kalem@fsk.unsa.ba)*

© 2023 The Author(s). This work is licensed under a Creative Commons Attribution 4.0 International License.



transport for traffic. The safety standards of the system should not be compromised by the integration of light vehicles on shared tracks. To ensure complete separation of trains, various measures can be taken that will affect the vehicles, infrastructure, and operations. Ideally, the vehicles that operate on shared tracks will be equipped with compatible operating mechanisms like automatic train protection (ATP). Additionally, the infrastructure must be designed in a way that ensures the vehicles are easily detectable and can interpret the signals in all types of running systems [3]. A procedure based on risk analysis, compliance checking, and approval of the tram-train system is presented in this paper.

## 2 Tram-Train System

The tram-train concept is a type of transportation system that combines the features of both tramway and railway systems. Tram-trains are light rail vehicles (LRVs) that are designed to operate on both tram tracks in urban areas and railway tracks in suburban and rural areas. The tram-train system enables passengers to travel directly from their local tram stop to destinations that are further away, without having to change transportation modes. This integrated approach offers many benefits, including improved connectivity, reduced travel time, enhanced cost-effectiveness, increased flexibility, and improved sustainability.

Definitions according to the directive 2016/797 [4]:

*"tram-train"* means a vehicle designed for combined use on light rail infrastructure and heavy rail infrastructure;

*"existing railway system"* means the infrastructure comprising the tracks and fixed installations of the existing railway network, as well as railway vehicles of all categories and origins that operate on that infrastructure;

*"light rail"* means an urban and/or suburban railway transport system with collision resistance of C-III or C-IV (in accordance with EN 15227:2011) and a maximum vehicle strength of 800 kN (longitudinal compressive force in the coupling area of wagons); light rail systems may have their own track or share it with road transport and typically do not exchange vehicles with passenger or freight transport over long distances.

Essential features of a tram-train system are [5]:

- **Dual-mode capability:** Tram-trains must be able to operate on both tramway and railway tracks, allowing them to travel between urban and suburban/rural areas.
- **Seamless integration:** The tram-train system must be integrated with existing urban and railway transport networks to provide passengers with a seamless journey.
- **Compatibility:** Tram-trains must be designed to be compatible with both tramway and railway tracks, including signaling systems, track gauges, and overhead power supply systems.
- **Flexibility:** The tram-train system must be adaptable and flexible to accommodate different types of passenger and freight transportation needs.
- **Accessibility:** Tram-trains must be designed to be accessible to all passengers, including those with disabilities, with features such as low-floor designs, wide doors, and wheelchair ramps.
- **Safety:** Tram-trains must meet rigorous safety standards, including advanced train protection systems, crashworthiness, and emergency communication systems.
- **Sustainability:** Tram-trains should be designed to be environmentally friendly, with features such as regenerative braking, energy-efficient lighting, and reduced noise levels.
- **Cost-effectiveness:** The tram-train system should be cost-effective, with minimal infrastructure modifications required and the ability to operate using existing tracks and stations.

Successful implementation of tram-train systems in Europe is mostly observed in cities with populations ranging from 100,000 to 300,000 [6]. There are also examples of successful systems in larger cities. For example, the Karlsruhe Stadtbahn in Germany, which is considered one of the most successful tram-train systems in Europe, serves a population of over 1 million people. The success of tram-train systems depends on a variety of factors, including the level of existing public transport infrastructure, land use patterns, and political will. Therefore, the population size of a city is not necessarily a determining factor in the success or failure of a tram-train system.

That being said, tram-train systems are generally considered most suitable for medium-sized cities

where the demand for public transport is high enough to justify the investment in infrastructure, but not so high that heavy rail solutions are necessary.

## 2.1 Track gauge width

Track gauge width is the distance between the inner edges of the heads of two rails measured 14–16 mm below the rolling surface plane (see Figure 1). The track gauge width is not the same in all countries. In many countries, it varies from region to region. Based on the track gauge width, railways are divided into five categories [7]:

- Standard gauge: mostly includes a width of 1435 mm. This distance was established by the British engineer George Stephenson (1781-1848);
- Broad gauge: mainly includes the following gauges: 1,520/1,524 mm (former Soviet countries), 1,600 mm (Irish gauge), 1,665 mm, and 1,667 mm.
- Metric gauge: mostly includes the following widths: 914 mm, 950 mm, 1,000 mm (meter gauge), 1,050 mm, and 1,067 mm.
- Narrow gauge: includes gauges from 600 mm to 900 mm. These gauges are usually used for secondary lines (e.g. industrial areas, factories, and mining service lines). Narrow gauges are also called "narrow track".
- Mixed gauge: this category includes gauges on which trains with different wheelbase widths can simultaneously operate.

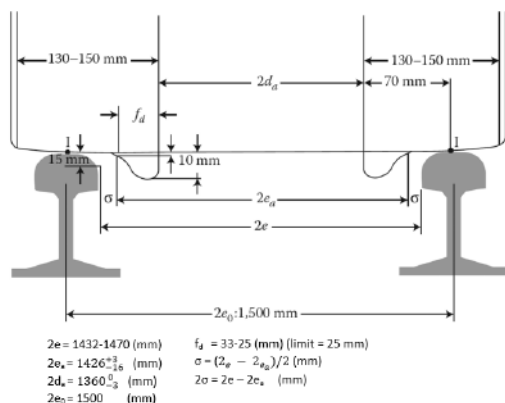

Fig. 1. Standard gauge railway - geometric and constructional dimensions [8]

The track gauge used in tram-train systems can vary depending on the specific system and location. In Europe, the most common track gauge for tram-trains is the standard gauge of 1,435 mm. However, some systems use narrower gauges, such as 1,000 mm or 1,067 mm,

particularly in cities where tramways were historically built with narrower gauges. In North America, standard gauge is typically used for tram-trains. The track gauge used in a particular system is determined by various factors, including historical tramway infrastructure, available space, and design requirements. In order to be compatible, the various systems such as trams, light rail, conventional railway, or metro must have the same track gauge. Since the rails in subway tunnels are not exposed to rain, snow, or other forms of precipitation, they are often affixed directly to the ground rather than resting on ballast, like normal railways.

## 2.2 Power supply system

The traction power supply is a critical aspect to consider for tram-train systems. Light rail systems usually operate on lower voltage supplies, ranging from 600 to 750 Vdc, while conventional railways use higher voltage supplies such as 1,500 or 3,000 Vdc and 15,000 or 25,000 Vac [3],[9]. Electrifying non-electrified railway lines for light rail operations usually poses no technical challenges, and existing clearance requirements can usually be met without the need to raise existing structures to allow conventional rail vehicles to pass under the light rail wires.

However, the line owner may object to light rail electrification, as it could create an entry barrier for other potential train operators who may want to use the line in the future. Adapting existing vehicle traction devices to run on railway or metro lines that have been electrified to higher voltages requires a dual voltage system, which can be complex to design due to the limited available space. In some cases, diesel light rail vehicles may be a suitable alternative, particularly for longer routes with a relatively high degree of separation and low traffic density. Hybrid traction or energy storage systems could be used in similar vehicles in town and city centers. Overall, careful consideration is necessary when choosing the appropriate traction power supply system for tram-train systems.

## 3 Interconnection in tram-train system

In the tram-train concept, it is important to ensure smooth interconnection between the subway and main railway lines. This can be

achieved by either physically connecting the tracks of the two systems or by providing a seamless transfer of passengers between the two systems at a designated interchange station. The physical connection of tracks is generally preferred as it allows for a more efficient use of infrastructure and rolling stock. However, this option can be technically challenging and may require significant modifications to existing railway and subway systems. The seamless transfer option involves building an interchange station that is designed to facilitate easy transfer of passengers between the two systems, with minimum disruption to the existing operations. This option may be more feasible in cases where physical connection of tracks is not possible or practical. Overall, careful planning and coordination are required to ensure effective interconnection of subway and main railway lines in the tram-train concept.

In some cities, there are two levels of urban railways: a rapid transit system such as the Paris Metro, Berlin U-Bahn, London Underground, and a suburban railway transport system such as the RER in Paris and S-Bahn as a rapid urban rail transit around Berlin. These systems are different and known as S-Bahn trains, suburban services, or regional railways. Suburban transport systems may have their own dedicated rail network with train frequencies as well as fast transit urban lines. In many countries, the national railway company manages suburban transportation. In some cities, these suburban services pass through tunnels in the city center and have direct transfers to rapid transit systems, on the same or adjacent platforms. The Stratford station in London is shared by London Underground trains –left and mainline railway services - right (see Figure 2).



**Fig. 2.** Interconnection of subway and main railway lines

(<https://commons.wikimedia.org/w/index.php?curid=485689>, 10.3.2023.)

In some cases, such as the London Underground, rapid urban transit and suburban transportation run on the same track along certain sections. The California Bay Area Rapid Transit (BART) system, which connects the San Francisco Bay and has 50 stations with six lines, is an example of a hybrid system of two modes of urban transportation. In the suburbs, the lines function as suburban railway lines, with longer intervals and greater distances between stations, while in the city center, the distances between stations are shorter and many lines intersect with intervals characteristic of rapid urban transit.

#### **4 European legislation on tram-train systems**

By allowing light rail vehicles to run on conventional railway infrastructure, the tram-train provides a broader range of direct transportation services and minimizes waiting and transfer times. However, implementing this hybrid system poses various technical challenges that must be addressed, including designing compatible traction power supply systems, rolling stock, gauges, tire and rail profiles, ensuring structural strength, facilitating passenger access, and implementing appropriate signaling.

The European legislation on tram-train systems is primarily governed by the European Union's Directive 2008/57/EC [10] on the interoperability of the rail system within the Community. This directive establishes a regulatory framework for the harmonization of technical specifications and procedures for the construction, operation, and maintenance of railway systems, including tram-train systems. The Directive outlines specific requirements for the design, construction, and operation of tram-train systems, such as track gauge, signaling, and rolling stock compatibility. It also requires that all tram-train systems be certified as interoperable before they can be put into service.

Additionally, the European Union has established funding programs to support the development and implementation of tram-train systems. These programs include the Connecting Europe Facility (CEF), which provides financial support for the development of rail infrastructure, and the Horizon Europe program, which supports research and innovation in transportation technologies.

Each EU member state has its own regulations and guidelines for the implementation of tram-train systems, which must comply with

the EU directive. Therefore, the specific legislation and requirements for tram-train systems may vary depending on the country.

Subways, trams, and light rail systems in many European Union member states are subject to local technical requirements. Such local public transport systems usually do not require permits. Trams and light rail systems are often subject to road legislation because they share infrastructure with road traffic. For these reasons, such local systems may not need to be interoperable and should therefore be excluded from the scope of the Interoperability Directive 2016/797 [4]. The 2016/797 directive, also known as the "Technical Pillar" of the Fourth Railway Package, amended the earlier Directive 2008/57/EC on the interoperability of the rail system within the European Union. The amendments made by the 2016/797 directive relate to the certification of railway systems, including tram-train systems.

The Directive sets out new rules for the certification of railway systems, aiming to simplify and streamline the process. It introduces the concept of a single safety certificate and a single entity in charge of maintenance for the entire railway system. This is intended to reduce administrative burdens and costs for railway operators, including those operating tram-train systems.

Like the earlier Directive 2008/57/EC, the 2016/797 directive applies to all railway systems within the European Union, including tram-train systems. It is designed to ensure a high level of safety and interoperability for these systems, while also promoting innovation and reducing administrative burdens for operators.

This does not prevent voluntary application of the provisions of this Directive to local railway systems if deemed appropriate.

Tram-train is a public transport concept that enables combined operation on both light rail and heavy rail infrastructure. Vehicles primarily used on light rail infrastructure, but equipped with certain heavy rail components necessary for limited operation on heavy rail infrastructure solely for the purpose of connectivity, may be excluded from the scope of measures implementing the Interoperability Directive. When tram-train systems use rail infrastructure, compliance with all essential requirements as well as with the expected level of safety on the relevant lines should be ensured.

## 5 Procedure for approving a rail vehicle

Overall, the approval procedure for tram-train systems is a complex and multi-step process that involves a variety of stakeholders, including government agencies, transportation authorities, and private sector partners. Effective communication and collaboration between these stakeholders is critical to the success of the approval process and the safe and successful implementation of tram-train systems.

Commercial train traffic across the entire railway network requires the alignment of the properties and infrastructure of the vehicles. The quality of service, safety, and interoperability of the railway system as a whole depend on such alignment and interconnection [11]. Before putting vehicle into operation, their technical compliance and safe integration with the system they are being connected to are thoroughly checked. Approval of mobile units for operation on the infrastructure network is based on an assessment of safety levels. The official safety assessment procedure was introduced by the British Coastal Protection Agency and incorporated in 1977 into the Safety Assessment Directive by the IMO (International Maritime Organization) (see Figure 3). This risk assessment method consists of five stages: risk identification, risk assessment, risk management, cost-benefit analysis, and decision-making.

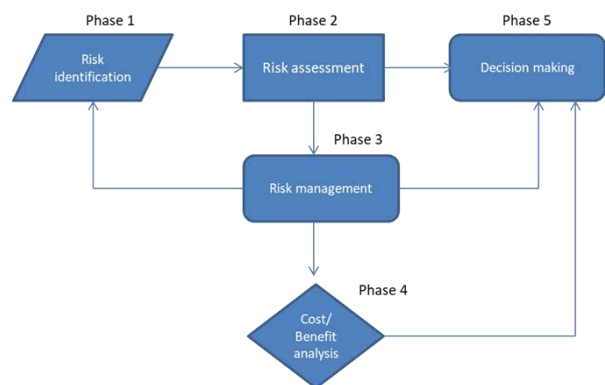

Fig. 3. Structure of safety assessment [12]

Also, the approval procedure for vehicles in tram-train systems is a rigorous process that involves a variety of technical and safety considerations. Effective communication and collaboration between vehicle manufacturers, system operators, and regulatory agencies is

critical to the success of the approval process and the safe and successful operation of tram-train systems.

### 5.1 Risk assessment

The role and responsibility of assessment bodies within the Common Safety Methods (CSMs) for risk assessment and evaluation are defined by Regulation (EU) No 402/2013. Essentially, the process of risk assessment and evaluation within the CSMs is carried out in three steps [13]:

- 1 Identification of hazards;
  - a. Safety requirements,
  - b. Safety measures.
- 2 Analysis and assessment of risk based on the principles of risk acceptance;
- 3 Demonstration of the system's compliance with identified safety requirements.

Directive 2016/798 is another component of the Fourth Railway Package, and it specifically addresses the safety of tram-train systems. The directive sets out safety requirements for the design, construction, and operation of tram-train systems, with the aim of ensuring a high level of safety for passengers and workers. The directive requires that all tram-train systems be subject to a safety assessment, which must take into account the specific characteristics of the system, including its integration with existing infrastructure and the use of both tram and train modes of operation. The safety assessment must be carried out by an independent body, and it must be updated regularly. In addition, the directive sets out specific requirements for the training and certification of drivers and other staff involved in the operation of tram-train systems. It also requires that appropriate safety management systems be put in place to ensure ongoing safety of the system

Directive 2016/798 stipulates that infrastructure managers and railway companies establish their Safety Management Systems-SMS [14]. The Safety Management System includes procedures and methods for performing risk assessment and implementing risk control measures whenever changes in operational conditions or the acquisition of new assets impose new risks on infrastructure or operational activities. (Figure 4).

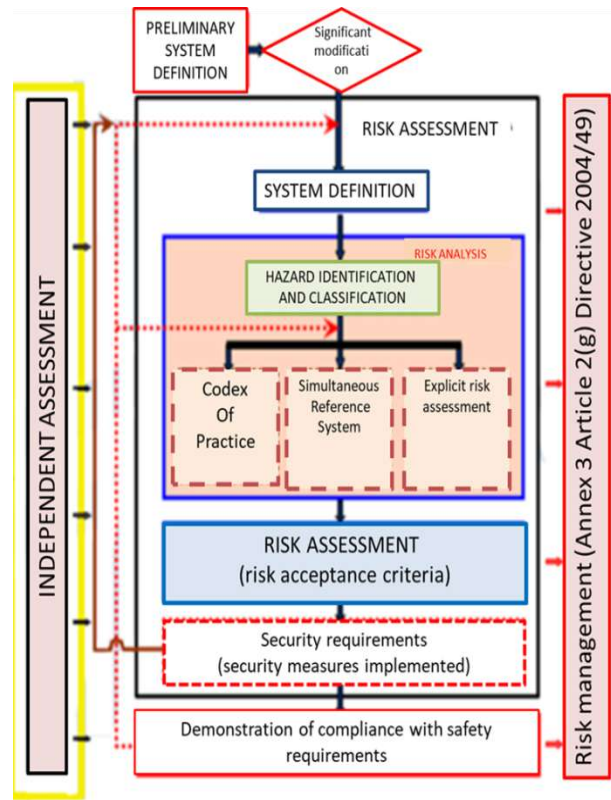

Fig. 4. Risk management process [13]

Like other EU railway directives, Directive 2016/798 is binding on all member states of the European Union, and it applies to all tram-train systems operating within the EU. Its aim is to ensure a high level of safety and interoperability for these systems, while also promoting innovation and reducing administrative burdens for operators.

### 5.2 Acceptability of risk

The railway company should define principles for adopting the level of acceptable risk and levels that will be defined for different risk categories. Possible consequences (category of consequences depending on the size of damage/loss) of hazards that may occur must be identified. Categories of severity of consequences of hazardous situations are those defined in standard EN 50126. The risk of a hazard is determined not only by the size of the damage it can cause, but also by its likelihood or probability of occurrence. Calculated risks must be classified into risk classes, and for each risk class, conditions of its acceptability must be defined [6]. The acceptability of risk of tram-train systems is a complex issue that involves balancing the benefits of the system against its

potential risks. Tram-train systems, like all forms of transportation, involve some level of risk, including the risk of accidents or collisions. However, the level of risk can be mitigated through the implementation of appropriate safety measures and the adherence to safety regulations and standards.

The acceptability of risk for a tram-train system will depend on a number of factors, including the level of safety measures in place, the level of demand for the system, the potential benefits to the community, and the availability of alternative transportation options. Ultimately, the acceptability of risk will depend on the perception of the system by the public, as well as the regulatory and decision-making bodies responsible for its implementation. It is important that these stakeholders carefully consider the potential risks and benefits of tram-train systems in making decisions about their implementation. In many cases, the acceptability of risk can be improved through a transparent and open communication process with the public, including regular updates on safety measures and ongoing efforts to improve the system's safety performance.

## 6 Conclusion

Tram-train systems are a valuable form of public transportation that can provide many benefits, including improved mobility, reduced congestion and emissions, and increased accessibility to jobs, education, and other services. Tram-train systems combine the flexibility and convenience of light rail transit with the speed and capacity of heavy rail, allowing for seamless integration with existing infrastructure and increased connectivity between urban and suburban areas. While the implementation of tram-train systems can be complex and challenging, with careful planning and investment, they can be successfully integrated into the transportation network of cities and regions. However, it is important to carefully consider factors such as safety, cost, and public acceptance when making decisions about the implementation of tram-train systems. Approval procedure is required to ensure their safe operation and interoperability with the infrastructure. Overall, tram-train systems represent a promising solution to many of the challenges facing modern transportation systems, and as technology and innovation continue to

evolve, they are likely to play an increasingly important role in shaping the future of public transportation.

## References

- [1] R. Ventura, M. Bonera, M. Carra, B. Barabino, and G. Maternini, "Evaluating the viability of a Tram-Train system. A case study from Salento (Italy)," *Case Stud. Transp. Policy*, vol. 10, no. 3, pp. 1945–1963, 2022, doi: 10.1016/j.cstp.2022.08.009.
- [2] M. De Aloe, R. Ventura, M. Bonera, B. Barabino, and G. Maternini, "Applying cost-benefit analysis to the economic evaluation of a tram-train system: Evidence from Brescia (Italy)," *Res. Transp. Bus. Manag.*, no. November, p. 100916, 2022, doi: 10.1016/j.rtbm.2022.100916.
- [3] M. Novales, A. Orro, and M. R. Bugarí, "Tram-train: New public transport system," *Transp. Res. Rec.*, no. 1793, pp. 80–90, 2002, doi: 10.3141/1793-11.
- [4] European Union, "DIRECTIVES DIRECTIVE (EU) 2016/797 OF THE EUROPEAN PARLIAMENT AND OF THE COUNCIL of 11 May 2016 on the interoperability of the rail system within the European Union," *Off. J. Eur. Union*, vol. 2014, no. December 2015, pp. 44–101, 2016.
- [5] G. Maternini, S. Riccardi, and M. Cadei, "Effects of the realization of a new tram-train system for the regeneration of urban areas. The case of the metropolitan area of Brescia," vol. 2012, pp. 39–49, 2012.
- [6] A. Nash, "A CHECKLIST FOR SUCCESSFUL APPLICATION OF TRAM-TRAIN," 2012.
- [7] C. Wang, X. Li, P. Chen, Y. Xie, and W. Liu, "Spatial pattern of railway geosystem and development mechanism from the view of gauge: A case study of Eurasia," *Dili Xuebao/Acta Geogr. Sin.*, vol. 75, no. 8, pp. 1725–1741, 2020, doi: 10.11821/dlxb202008012.
- [8] C. N. Pyrgidis, *Railway Transportation*

*systems. Design, Construction and Operation (2nd ed.). CRC. .*

- [9] A. Bartolomei, C. Carnevali, R. Genova, and A. Sasso, "Interoperable vehicles 'tram-train': Possibility of using Press-Pack IGBT for traction converters," 2004.
- [10] European Commission, "DIRECTIVE 2008/57/EC OF THE EUROPEAN PARLIAMENT AND OF THE COUNCIL of 17 June 2008 on the interoperability of the rail system within the Community," *Off. J. Eur. Union*, no. L101, p. 45, 2008, [Online]. Available: <https://eur-lex.europa.eu/legal-content/EN/TXT/PDF/?uri=CELEX:32008L0057&from=en>.
- [11] Đ. R. Čabrić N., "Metode analize i procjene rizika," *Treći BiH Kongr. o željeznicama Sarajev.*, 2015.
- [12] K. Bichou, "Security and Risk-based Models in Shipping and Ports: Review and Critical Analysis," pp. 111–141, 2009, doi: 10.1787/9789282102329-6-en.
- [13] The European Commission, *COMMISSION IMPLEMENTING REGULATION (EU) No 402/2013*, no. 402. 2013, pp. 8–25.
- [14] European Parliament and Council of the European Union, "Directive (EU) 2016/798 of 11 May 2016 on railway safety (recast)," *Off. J. Eur. Union*, no. May 2016, pp. 102–149, 2016.

# Contribution to the development of urban mobility in the city of Sarajevo by implementation of smart mobility hub's

Mirzet Sarajlić<sup>1</sup>, Drago Ezgeta<sup>2</sup>, Adnan Omerhodžić<sup>2</sup>, Nedim Kamenjašević<sup>3</sup>

<sup>1</sup> Canton Sarajevo - Ministry of Traffic, Reisa Džemaludina Čauševića br.1. Sarajevo, 71000 Sarajevo, Bosnia and Herzegovina

<sup>2</sup> University of Sarajevo, Zmaja od Bosne 8, 71000 Sarajevo, Bosnia, and Herzegovina

<sup>3</sup> Canton Sarajevo - Cantonal Administration for Inspection Issues, Aleja Bosne srebrene bb, Sarajevo, 71000 Sarajevo, Bosnia, and Herzegovina

## Abstract

The paper provides general information and guidelines for the development of Mobility the Hub's Action Plan of the City of Sarajevo. The action plan will cover a short-medium term time frame and vision, establishing a series of actions and measures to look for a visible and different concept of mobility through five basic components, such as: infrastructure, electromobility, auxiliary services, renewable energy sources and digital solutions. The main purpose of the work is to reduce the negative effects of traffic on citizens and the environment, encourage the transformation of urban mobility and direct the way of thinking towards sustainable development. Above all, defining the criteria for locating mobility hubs in urban areas. The conclusion is that mobility nodes are built in places of high concentration of people, which are places of exchange of passengers and places to which a large number of people gravitate. The Mobility Hub's concept represents an attractive location/facility that offers users options for environmentally clean and practical modes of travel. It unites infrastructure and services in one place, creating a reliable model for a new way of moving around the city that saves money, is healthier, and increases involvement in green city transportation.

**Keywords:** *Mobility hubs, Infrastructure, Electromobility, Auxiliary services*

## 1 Introduction

The need for more sustainable and integrative solutions in sectors related to urban mobility is generally recognized. At the European level, these solutions are gaining increasing recognition and importance.

The initial information that enabled the research in this paper is based on the global trend of favoring means of urban mobility in cities. The purpose of writing the paper is identified as contributing to a more intensive development of urban mobility, while the research in this paper will be useful for further research and implementation of the results in practical application.

Bearing in mind that the city of Sarajevo and the Canton of Sarajevo, through the Sustainable Urban Mobility Plan, entered the phase of

satisfaction for a better quality of life, there was a need to upgrade such a strategic plan [1].

New approaches to urban mobility planning include encouraging the transition to cleaner and more sustainable modes of transport, such as walking, cycling, and public transport; new patterns of car use and ownership; the use of new technologies; and the adoption of new concepts of sustainable urban logistics.

City transport is facing the challenges posed by the new technologies and the undergoing socioeconomic and demographic changes, seeking more efficient solutions and mobility services tailored to citizens' new travel behaviors and needs. The goal of this work is to offer a theoretical and scientific approximation of the modeling of the location selection of mobility hubs in selected environments so that this concept

---

Corresponding author: Mirzet Sarajlić ([mirzet.sarajlic@fsk.unsa.ba](mailto:mirzet.sarajlic@fsk.unsa.ba))

© 2023 The Author(s). This work is licensed under a Creative Commons Attribution 4.0 International License.



can be further applied to other cities around the world, which imply the transformation of the traffic system from conventional to ecologically sustainable modes of transport.

## **2 The defined vision in the Sustainable Urban Mobility Plan (SUMP)**

The defined vision in the Sustainable Urban Mobility Plan (SUMP) is as follows: Sarajevo, open to innovations in sustainable urban mobility, a place of safe and comfortable living, clean air, and providing all its citizens with various mobility opportunities; accessible and affordable zero and low emission public transport; and wide opportunities for intensive development of non-motorized movement. This vision also depends on the aims of "sharing" and "smart" technology to create a collaborative ecosystem of smart cities that are comfortable to live in, appealing, and efficient in terms of departmental efficiency.

Today's urban transportation requirements are as follows:

- addressing the challenges of air pollution and noise pollution in urban areas,
- redesigning mobility models, establishing new infrastructure that supports innovative mobility,
- constant restructuring of the public sector as part of sustainable urban development, and
- collaboration of all city actors in the adoption of new mobility practices.

It is intended to develop creative mobility solutions that encourage public transportation and active modes of transportation, as well as a smart, environmentally friendly method of mobility, while simultaneously lowering individual transportation and automobile ownership. To enhance sustainable transportation, comprehensive action plans should be developed using new methodologies and instruments. The new notion, which will be developed further in this text, can 'trigger' changes by providing a visible and significantly distinct concept of mobility through Mobility Hubs.

A mobility hub is a physical location that satisfies the specific requirements of the community in which it is situated. The 'Lego'

concept of being able to install a variety of physical items linked to mobility (eScooters, eBikes, eCars) or more general services (café, smart solar benches, green environment, storage lockers, etc.) that are appropriate for the site. It also allows for simple extension as the demands of the environment change. Its practicality and variety of mobility modes, increased accessibility across the city, and beautiful architecture will allow the establishment of a "5-minute city." The "5-minute city" goal implies the availability of shared electric transportation within a 5-minute walk of anything in the city. This should become the fundamental basis around which the future of urban transportation is built.

Smart mobility is a revolutionary way of thinking about how we move toward a greener, safer, and more efficient future. It refers to using alternative means of transportation in addition to or instead of owning a conventionally fueled personal automobile. Urban mobility plays a key role in the ecosystems of complex smart cities. It is considered a key factor in enabling cities to become more intelligent, which highlights the importance of identifying the drivers that improve the intelligence of cities [2]. Ridesharing, automobile sharing, public transit, walking, bicycling, and other modes of smart mobility exist. The demand for smart mobility has developed as a result of increased traffic congestion and its accompanying negative effects, such as pollution, deaths, and wasted commute time.

Shared Mobility is a transportation service that refers to non-owned modes of transportation (car, bicycle, scooter, etc.) that the public may hire for short-term journeys on an hourly or daily basis.

### **2.1 Step-by-step procedure for developing action plans.**

The purpose of this document is to provide effective solutions as well as a general strategy for developing mobility hubs. The primary phases in developing mobility hub action plans are as follows:

- Step 1: Framework analysis,
- Step 2: Conducting a self-assessment,
- Step 3: Stakeholder analysis,
- Step 4: Diagnosing mobility hub's and setting goals,

- Step 5: Development of scenario and long-term vision, and
- Step 6: Development of an effective mobility hub action plan.

Step 1: Framework Analysis: The first stage in developing a mobility hub action plan is to identify the overall traffic and mobility framework. The goal of this stage is to identify the fundamental scenario for current traffic and mobility circumstances in terms of legislative and regulatory framework, framework for traffic and mobility planning, sustainable forms of transportation, and/or planned collaborations, and so on. It is vital to inquire as to how the notion of the mobility hub fits into the city's strategic goals. In this regard, a preliminary assessment of the current situation is recommended in terms of regulatory constraints and obligations for the implementation of the mobility hub concept, relevant strategic traffic and mobility plans that are in force or are still being developed (including all measures that are already in the strategic traffic documents approved by local governments), passenger and goods mobility services in municipalities, and partnerships that want to implement the mobility hub concept. It is vital to determine the city's stance on urban mobility upgrading, if it is legally supported, and whether this notion of the hub of mobility is sufficiently progressive in light of the change in terms of clean, green, and healthy mobility.

Step 2: Conducting a self-assessment: The second phase in developing an action plan is for the body that "leads the job" to undertake a self-assessment, identifying possible drivers and impediments that may aid in the process of unifying the vision and setting strategic objectives at the city or municipal level.

Step 3: Stakeholder analysis: Mobility hubs will always be of interest to numerous stakeholders with diverse motivations. Understanding these stakeholders and communicating honestly and transparently with them is critical to ensuring that the model works and lasts. The city administration or municipality may play a primary convening role here, and local leadership is critical for formulating principles, deciding on a management mechanism, developing proper procedures, and serving as a role model to other ecosystem participants. It is critical to establish the needs and opportunities for cooperation in all key municipal and city policy areas, particularly those related to mobility

(including land use, energy, environment, social inclusion, economic development, health, and safety).

Step 4: Diagnosing mobility hubs and setting goals. The fourth step in creating a mobility hub action plan is to perform a passenger and goods mobility diagnostic to better understand the present traffic and mobility scenario as well as the obstacles that impede effective mobility. This will allow for the development of suitable mobility policies to meet local restrictions, mobility patterns, and identified challenges.

Step 5: Development of scenarios and long-term vision. The fifth step in developing a mobility hub action plan is to create a scenario and a long-term vision for attaining the stated and strategic objectives. The scenarios so formed describe the expected role and potential of emerging mobility solutions (namely autonomous vehicles, shared mobility, and electrification) and include socio-economic and environmental perspectives [4]. Setting aside strategic, organizational, and financial operations and concentrating on community needs and physical characteristics, municipal leaders are ideally situated (with the assistance of planners and policy advisers) to examine how and where their first portfolio of mobility hubs may look. Action plans should include the following time frames - short/medium term (1-5 years), and long-term vision (10 years).

The short- to medium-term period (1-5 years) encompasses "quick wins" and policy initiatives that must be designed and executed within realistic timelines to create meaningful outcomes. This is the goal timetable for the Mobility Hub Action Plans, which should contain push and pull activities that will be undertaken by the towns participating as discussed in many instructions [8]-[9].

Step 6: Development of an Effective Mobility Hub Action Plan The sixth step in developing a mobility hub action plan is to devise cost-effective strategies that address the two time periods under consideration. The final step is to decide which method best suits the vision. The development of successful smart mobility, e-mobility, and other measures is at the heart of action plans whose ultimate purpose is to assure the achievement of set strategic goals. Essentially, measurements are identified in this phase in answer to the questions: what, how, where, and when? Individual experience, study, and local

interaction should not be used to determine the most successful solutions. Any initiative for local transportation and mobility that is already "on the agenda" of local authorities in the relevant strategic planning documents is a Memorandum of Understanding, a non-binding agreement between two or more parties setting out the terms and details of the understanding, including requirements and the responsibilities of each party.

### 3 Potential mobility hub's locations in city of Sarajevo

Mobility hubs, according to their idea, should bring together various infrastructures, equipment, and services to attract, promote, and satisfy people's desire to reach all sections of the city from wherever they begin their trip. It will allow the "5-minute city"—assuring access to needed amenities within a 5-minute walk to enable a clean, green, inexpensive, and healthy trip—with its practicality and variety of transport modes, boosting accessibility in the city, and its design and beautiful form.



Fig. 1. Concept location of mobility hub-s [5]

Locations where mobility hubs will almost surely provide benefits that many people are already aware of can be [7]:

University Campus: "captive audience" will be well aligned with all parts of what the mobility hub incorporates and provides, and the location is often physically built to absorb the infrastructure efficiently.

Railway stations or bus stations will most likely already have some facilities for bikes.

Many cities are attempting to turn their railway stations from filthy locations where the public does not want to go to nice and exciting places. Because they are public transportation hubs, a large number of people circulate here; therefore, the visual shift is quite noticeable to a broad portion of society.

Residential areas provide suitable places for dense housing where many people will demand access to shared inclusive micromobility, whether public, private, or mixed ownership. These habit-changing places may also benefit from the unique 'place-shaping' qualities of mobility hubs and special incentive processes ('push theory'). Transport modes for passengers and freight were highlighted in each scenario, along with possible implications for the individual, society, industry, and government levels [3]. Offering communal amenities (such as new shared facilities, a children's playground, equipment, or similar) for collective individual behavior improvement, for example, this may foster a good feeling of local collaboration. In such places, an inclusive agenda may be quite effective in terms of political appeal.

Park and Ride Locations: where a common location might encourage passengers [6] to explore shared e-cars as an alternative to bus transit to the city. It may, in fact, encourage those same individuals to share clean transportation on incoming trips to the park and ride.

TOURIST AND CULTURAL CENTERS - Many of them are historic sites with narrow streets and no parking.

PARKS: As people are inclined to relax, this is a chance to stress the "green" agenda and provide several supplementary services. Security and emergency response may also be included by offering a well-lit area on dark nights with 'push-to-talk' capabilities enabling worried citizens to speak to the operations center and raise security alarms, or the known position of a defibrillator if a medical emergency occurs.

Commercial areas and shopping centers: transportation alternatives for more people may be supplied by old-world technology; storage cabinets can be useful; and shared light eMobility possibilities are a welcome shift.

### 3.1 Location 1 – (NEDŽARIĆI - Novi Grad)

Due to the closeness of the student dormitory, as well as the “Alipašino polje” residential neighborhood, a considerable number of trips occur. The target demographic is students, who are prospective consumers of micro-mobility and other services. Students are usually an excellent target audience for strategies to promote the use of these services. Furthermore, private automobile ownership is quite low among this group of prospective consumers.



Fig. 2. Visualization of location 1

### 3.2 Location 2 – (OTOKA - Novi Grad)

RESIDENTIAL AREA is suitable for the Mobility Hub for the following reasons: A high number of new journeys are arising as a result of the newly constructed residential area and the concentration of a large number of inhabitants in that region. Attractions include the Olympic Pool, which is located near the retail mall and market. It is feasible to use the time spent shopping to charge electric vehicles, trolleybus and tram interchange, appropriate for changing and continuing the trip.



Fig. 3. Visualization of location 2

### 3.3 Location 3 – (THE UNIVERSITY CAMPUS – Novo Sarajevo)

The University Campus is suitable for the Mobility Hub for the following reasons: The movement of a large number of individuals, Due to the vicinity of a significant number of faculties, it might be regarded as a site with a high number of finishing and starting journeys. The closeness of the major bus and railway stations makes it easy for visitors to continue their trip to the city center and the historic section of town.



Fig. 4. Visualization of location 3

### 3.4 Location 4 – (NATIONAL MUSEUM – Novo Sarajevo)

Sarajevo center is suitable for the Mobility Hub for the following reasons: A tourist destination due to the National Museum itself, as well as neighboring retail and business areas, hotels, and so on. Due to the proximity of Wilson's promenade, one of the most renowned promenades along the Miljacka river, there is a high concentration of people. An excellent starting place for completing the trek to the city center on electric scooters. Proximity to high school and college: high school students are prospective customers of micro-mobility and other services, but they are also an excellent foundation for fostering innovative, green, and smart mobility technologies.



Fig. 5. Visualization of location 4

## 4 Conclusion

Mobility plays a vital role in our daily lives and has become a defining factor of current society, the way we live and move. Mobility, or the ability to move from one location to the other, links cultural, economic, social, and political aspects of our global society.

Global mobility demand continues to grow, along with the mobility systems' carbon impact. In order to manage future mobility demand, and a much-needed transition to sustainable, low carbon mobility, it will be crucial to achieve seamless transitions from one transport mode to another.

The sole provision of transport options will not be enough. Beyond providing the modalities necessary to manage a shift to more sustainable transport options, mobility behavior needs to shift in order to enable a successful adoption of these. Mobility hubs can constitute the missing piece – they can make alternative options easier, more attractive, and more convenient to use. The design, location and specifically the associated services of a mobility hub can influence this.

The outcomes of all the preceding processes will be summarized in mobility hub action plans. Following the final review, the representatives must officially accept the action plan at the municipal or city level. It is also critical that the action plan be generally approved by stakeholders and the public. Previous agreements must be examined internally and by key external stakeholders, including external reviewers, to verify that they accurately represent the draft plan. The shape and conditions of adopting action plans will be determined by the national or local regulatory framework and administrative structure.

In general, the following goals should be met: the entities in charge of developing actions and budgets should also accept the action plan, assuring conformity with national and local rules surrounding its approval and, in part, with the needs of Sarajevo's sustainable urban mobility plans.

The action plans must be evaluated in terms of procedural requirements and must be in accordance with the EC, national, regional, or local regulatory framework. To guarantee wide ownership of the plan, it is vital to educate and engage stakeholders (associate meetings) and people as part of this stage. Stakeholders and residents should feel as though this is "their"

strategy to increase mobility and quality of life. Before presenting the action plan to the public, it must be modified and harmonized depending on the outcomes of the pilot activities.

## References

- [1] T. Sobral, T. Galvão and J. Borges, "Visualization of urban mobility data from intelligent transportation systems," *Sensors (Switzerland)* (2019), vol. 15, no. 1, pp. 88-99, 2019.
- [2] P. A. M. S. A. Munhoz, F. Dias, C. K. Chinelli, A. L. A. Guedes and A. P. Soares, "Smart mobility: The main drivers for increasing the intelligence of urban mobility," *Sustainability (Switzerland)*, vol. 1, no. 1, pp. 102-110, 2020.
- [3] N. Gerdri, K. Sivara, C. Chatunawarat, S. Jaroonsathian and K. Tundulyasaree, "Roadmap for Future Mobility Development Supporting Bangkok Urban Living in 2030," *MDPI Journal*, vol. 14, no. 1, pp. 120-138, 2022.
- [4] M. Miskolczi, D. Földes, A. Munkácsy and M. Jászberényi, "Urban mobility scenarios until the 2030s," *Sustainable Cities and Society*, vol. 92, no. 1, pp. 78-82, 2021.
- [5] T. Klimke, "Mobility Islands on the roadmap to a new mobility future," *EU guide for city leaders*, no. 1, 2022.
- [6] Fondation Sharingcities, European Union "Mobility Islands Leadership Guide", no. 1, 2022.
- [7] Politecnico di Milano, Municipality of Milan, City of Ljubljana, City of Maribor, City of Zagreb, Municipality of Patras, City of Novi Sad, City of Sarajevo, Capital City "Tribute project – integrated and innovative actions for sustainable urban mobility upgrade", 2022.
- [8] Interreg adriion, Ceteor Sarajevo "Methodology for Development of the Mobility Island Action Plan", 2022.
- [9] Deutsche Gesellschaft für Internationale Zusammenarbeit (GIZ) GmbH, Ministry of traffic and communications Canton Sarajevo, City of Sarajevo "Sustainable Urban Mobility Plan for City of Sarajevo (SUMPs)", 2020.

# Study of barriers for the use of drones in the last mile logistics

Snežana Tadić, Ljubica Radovanović, Mladen Krstić, Miloš Veljović

Faculty of Transport and Traffic Engineering, University of Belgrade, 11000 Belgrade, Serbia

## Abstract

Effective last mile (LM) delivery is critical to efficient functioning of supply chains. In addition to speed and cost of delivery, environmental and social sustainability are increasingly important factors in last mile logistics (LML), especially in urban areas. Sustainable solutions involve application of various modern technologies. Autonomous vehicles and drones have attracted special attention of researchers in recent years, with their vast application potential. Despite potential benefits of deployment in LML, future of drone logistics is uncertain due to a number of barriers. Aim of this study is barriers analysis, evaluation and ranking, to identify those that prevent wider application of drones in LM to the greatest extent. For solving the defined problem this study used the fuzzy Delphi ANP (fuzzy DANP). Results indicate that the most critical barriers to implementation are lack of regulations, drone tracking, drone owners' liability and obstacle and collision avoidance. Higher perceived risk and short flight range are of lesser impact. The contribution of this study is in the fact that the analysis of barriers to the implementation of drones is assessed from different perspectives and interests of different stakeholders, which represents a new approach compared to previous research in this field.

**Keywords:** *drone logistics, barrier analysis, last mile, city logistics, fuzzy Delphi, fuzzy ANP*

## 1 Introduction

City is a location of the greatest concentration of people, economic and social activities, and logistics is extremely important for its functioning. Therefore, city logistics (CL) is a very important area of planning due to its close connection with the sustainable development of urban areas [1]. Globalization, the growth of the consumer society, the change of the production paradigm, the development of Industry 4.0 and the development of e-commerce cause various challenges in terms of achieving efficient and sustainable logistics, especially in urban areas [2]. The consequence of the aforementioned is the fragmentation of the market, an increase in home deliveries, an increase in the demand for more rapid deliveries, an increase in the frequency of delivery, a decrease in the volume of delivery, as well as the occurrence of personalized consumption patterns [3]. This significantly complicate the Last Mile Logistics (LML) processes. LML is the last stage of the supply chain where contact with the final consumer is

made. It is often described as the most complex, expensive, inefficient and polluting part of the supply chain [4]. Some studies estimate that Last Mile (LM) delivery accounts for 13-75% of total supply chain costs, depending on the influence of various factors [5]. Some of them are the complexity of the urban environment and the adaptability of the infrastructure to the operations of logistics providers, the occupancy rate of delivery vehicles, restrictions imposed by local authorities, the length of LM, the size and homogeneity of shipments, the required delivery times, traffic congestion, etc. In addition to the impact on economic sustainability, ineffective planning and management of LML has a negative impact on environmental and social sustainability. This is the consequence of the creation of congestion, air pollution, increased noise, reduced traffic safety, and damage to the infrastructure network.

According to research from the World Economic Forum in 2020, the number of

---

Corresponding author: Mladen Krstić (m.krstic@sf.bg.ac.rs)

© 2023 The Author(s). This work is licensed under a Creative Commons Attribution 4.0 International License.

deliveries in cities is expected to increase by 36% by 2030. This will generate a 32% increase in greenhouse gas emissions from delivery traffic, an increase in congestion by over 21% and an additional 11 minutes of commuting for every passenger on a daily level. These figures show the substantial importance, but also the pressure of the logistics sector in cities. Therefore understanding LML, as well as its effective planning and management, is of vital importance for obtaining economic, environmental and social sustainability of cities. Notwithstanding the problems founded in changes in supply chains, technological innovations enable the application of modern solutions for the delivery of LM. In addition to rate and cost of delivery, which are the most important factors for LML, environmental and social sustainability are taking on an increasingly important role. In this perspective, solutions such as autonomous vehicles and drones as a type of these vehicles can be a good choice both in terms of transport speed and sustainability. Being electrically powered, drones may reduce environmental impact and reduce road congestion as they do not interfere with land infrastructure [6]. Despite the potential advantages, the usage of drones is not widespread, and its future is uncertain due to several barriers such as regulations, legislation, a threat to privacy, security, public and psychological perception, and environmental, economic, and technical issues.

The aim of this study is to analyze the barriers to the application of drones for the delivery of LM. This is done by taking into account the conflicting demands of different stakeholders: providers and users of services, the city and regulatory bodies, the public and the population. In order to determine the priorities for resolving them, the , fuzzy Delphi ANP multi-criteria decision-making method (fuzzy DANP) is used. In the first step, the structure of the problem is defined, that is, the definition of barriers and their grouping. Afterwards an analysis is performed in order to determine the mutual influence of barriers and the intensity of that influence.

The study is organized in five sections. The following section describes the problem. Afterwards, a methodology is proposed implying a combination of methods for determining the significance and ranking the barriers for the use of drones. In the fourth section, the obtained results are presented. Finally, the last section presents conclusions and recommendations for future research.

## 2 Description of the problem

Delivery of goods by drones represents an innovative, promising and significant solution to many problems in LML. This has an impact on all participants and stakeholders. Customer demands are increasingly complex in terms of the availability of the desired product and the rate of delivery [7]. These issues can be addressed by efficient drone delivery [8], contributing to decrease in delivery costs, emissions and traffic congestion in cities. However, it should be taken into account that the application and acceptance of drones for the delivery of goods depends on many factors that must be further investigated and resolved.

Existing studies on consumer acceptance of delivery drones reveal that the privacy and sensitive personal data risk is one of the primary challenges when it comes to the acceptance of drone delivery technology [9]. In addition, security risk, fear of drones falling, risk of injury or loss of personal belongings are factors that influence the acceptance of new technology, while on the other hand, innovation and environmental acceptability are the main reasons for its adoption [10, 11].

Previous research has identified barriers to the implementation of drones that may be grouped into several categories [12]:

- Privacy and security
- Regulations and legislation
- Public acceptance and psychological perception
- Environmental issues
- Economic aspects
- Technical issues

### 2.1 Privacy and security (Ps)

The commercialization of drones may pose a threat to public privacy, particularly in the context of the delivery by drones. They may be equipped with cameras and other sensors that can collect data about people and objects on the ground, which might lead to:

1. Identity theft and collection of private information
2. Unauthorized non-consensual photographing and recording
3. Unauthorized usage of data and blackmail
4. Complex identification of unauthorized drones

5. Unauthorized usage of drones
6. Violations of rights
7. Physical attacks, obstruction and phishing
8. Intentional hacking, cyber attacks and terrorism

Many people are resistant to drones due to concerns about their privacy or safety due to the possibility of photographing, recording and monitoring private spaces without consent. In addition, it is complex to identify unauthorized drones, and determine when and who is performing filming [13].

Drones used for logistics applications may be very effective in delivering products to customers. However, in spite of the fact that they are primarily only used to collect basic information about the route and location of the delivery [14], they may additionally collect other data: information about customers, their addresses and locations of movement, the products they buy, payment cards information, the environment. However, these data may be used without the consent of the owner, and in this way the privacy and security of the user may be endangered. Given that drones can be easily accessible, there is concern that they might also be used without authorization. They can carry out illegal activities such as spying and the transfer of illegal substances (drugs, dangerous substances).

In addition to being used in logistics applications, drones may be used for other purposes, including terrorist activities, posing a serious risk to national security. They may be programmed to transport explosive devices or weapons and can be used to execute attacks on public places or critical infrastructure. Drones may be misused for cybercrime purposes. Drones may be hacked, which would allow attackers to take control of them and perform cyber attacks on systems located in the drone's operating zone [15,16]. They can be used for obtaining personal information, such as credit card information and other sensitive data. In addition to drones, drone transportation systems are vulnerable to cyber-attacks. They can be utilized to take control of drones and steal sensitive information about flight and other drone operations, which may lead to collisions between drones, collisions with other objects and/or people, and generate serious incidents.

## 2.2 Regulations and legislation (RI)

The government is responsible for regulating the use of drones in the delivery of goods in urban areas in order to protect the interests of the community and ensure the safety and privacy of residents [13]. The regulation of drone delivery aims to prevent possible accidents and property damage due to drone crashes or collisions with other objects. The regulation is also important to protect citizens' privacy and to prevent unauthorized surveillance that might be performed using drones. There are several barriers that may affect the implementation of drones in the delivery of LM, and they are related to regulations and legislation [12]:

1. Liability for drone owners
2. Drone routes
3. Insurance obligations
4. Operator certifications and training
5. Congested airspace for manned aircraft
6. Establishing liability
7. Lack of aviation regulation

Restrictions on the use of drones in certain airspace zones or altitudes and restrictions on the weight and size of drones may make it difficult to utilize drones for LM deliveries in urban areas. There are concerns that drones might pose a safety and security risk to air traffic. They might fly in close proximity to manned aircrafts, especially in urban areas, where airspace may be congested with scheduled commercial flights. Determining liability may be a barrier for the implementation of drones in LML. It is important to determine liability in the event of accidents or damage and identify regulations that govern this.

In addition, the use of drones for LM delivery may require special permits, training, certifications and licenses to operate drones. This requires additional time and resources. Drone owners are often liable for damage or accidents that occur during the usage of drones. This presents an additional challenge in terms of insurance and other measures to protect against potential damages.

Non-compliance of aviation and other regulations with new technologies and innovations may lead to uncertainty regarding the legal framework. This imposes challenges to planning and implementation of an effective strategy for the application of drones. The lack of aviation regulation may also lead to disparate market conditions between companies that use drones



and those that do not, which may affect competitiveness and innovation.

### **2.3 Public acceptance and psychological perception (Pp)**

According to a Polish study, 43% of the population expressed skepticism about the implementation of drones, implying the existence of social barriers to the adoption of drone delivery of goods [17]. Other studies in urban areas in Australia point out that traditional postal services are preferred over drone delivery despite recent advances in e-commerce and technology [18]. Societal anxiety about automation contributes to skepticism towards drones [12]. This is particularly due to the perception that they are mainly intended for military and surveillance purposes and/or are owned by terrorist groups [19]. Additionally, people express strain that the use of drones might lead to the disappearance of traditional retail, resulting in decrease of vacancies, increased stress levels, decreased social interactions, and the creation of an elite mode of mobility [20]. Social inequality is considered to be another significant barrier to the implementation of drone delivery due to the anxiety that drones would be available only to the wealthy [21]. In addition, social anxiety and security concerns are caused by the so-called cyber security of drones [16, 22]. Intolerance towards the usage of drones may be further reinforced by users' distrust in automation and technology. There is a concern that the drone or the package that it carries, might fall, thus posing a potential risk. Additionally, the inability to distinguish drones in the sky, i.e. non-transparency, can lead to mistrust towards drones and further rejection of their usage, as it may not be possible to distinguish between a drone used for commercial purposes and a drone used for illegal activities or terrorist attacks.

In the literature, barriers related to public acceptance and psychological perception are divided as follows [12]:

1. Greater perceived risk
2. Awareness of drone technology
3. Non-transparency
4. Social anxiety about automation
5. Annoyance of the public
6. Usage of drones in the private sector
7. Drones and theft

### **2.4 Environmental issues (En)**

The attitude of users towards the delivery of goods by drone largely depends on the extent of the impact their usage poses on the environment. Large-scale deployment of drones has been found to reduce pollution more effectively in rural than in urban areas [23].

Drones cause noise pollution as well, CO<sub>2</sub> emissions and visual pollution [24–27]. Drones are powered by engines, which emit gases into the atmosphere, including CO<sub>2</sub> and other harmful gases. The amount of CO<sub>2</sub> emissions produced by drones is relatively small compared to other types of transport, such as internal combustion vehicles. However, if drones are used on a large scale, the emissions may gradually accumulate and contribute to the total emissions, especially if the drones have to travel longer distances [28].

Studies that tested the impact of drone noise near busy and less busy roads show that sound disturbance on busy roads is concealed by traffic noise and is only 1.13 times higher than without drone noise, compared to less busy roads where sound disturbance generated by drones is 6.4 times higher. This indicates that planning drone routes near busy roads would significantly reduce noise pollution [29].

Shadowing is another impact that drones pose on the environment [16]. Since drones fly above the ground, they may produce sounds and noise that may affect animals and people nearby. In addition, the shadows of drones in flight may also cause "visual pollution" and disrupt people and animals on the ground. Adverse weather conditions (wind storms, snow storms, poor visibility and thunderstorms) represent a major challenge for the undisturbed delivery with drones [18, 30].

Research suggests that drones may affect animals in different ways [22, 31]. For example, flying drones may disturb birds and alter their natural behavior. Moreover, birds and other animals may be physically harmed in the event of collision with drones [13]. There are additional concerns that flying drones might affect the migration of birds, since they use sound as a navigation tool, therefore drone noise may disrupt their ability to navigate. Hence, it is important to use drones in a responsible manner, in compliance with legislation and regulations, in order to minimize the negative impact on animal life.

Accordingly, when considering the usage of drones for LM delivery, the environmental impact should also be taken into account [12]:

1. CO2 emission
2. Impact on animals and birds
3. Visual and sound pollution
4. Particle emission

### 2.5 Economic aspects (Ec)

Although the usage of drones may be more efficient and decrease costs compared to traditional delivery methods, there are economic challenges to consider as well. Investing in drones and related technologies can be costly. In addition to the drone itself, it is necessary to make further investments in software, sensors, surveillance cameras and other technologies required for the safe and efficient operation of the drone. Moreover, operator training and certification costs imply additional resources and expenses.

As with other technological innovations, the introduction of drones in the logistics industry may lead to changes in the labor market. Although package delivery drones create new vacancies, the reduction in the use of trucks and other vehicles in logistics may lead to a reduction in the need for drivers and other personnel in the logistics sector. The introduction of new technologies may contribute to an increase in the economic gap between the rich and the poor, thus exacerbating existing social inequalities and socioeconomic problems [16]. From the economic aspect, the barriers are grouped into [12]:

1. High initial costs
2. Economy and employment
3. Disruption of the transport industry
4. Uneven distribution of income

### 2.6 Technical issues (Te)

There are several crucial technical performance challenges that affect the successful deployment of drones [12]:

1. Short flight range
2. Navigation
3. Adverse weather conditions
4. Obstacle and collision avoidance
5. Drone tracking
6. Limited transport capacity

Drones are limited by their autonomy and battery life, which is a challenge for more extensive flights or for operations in remote

locations [32]. Furthermore, drones may encounter technical barriers, such as adverse weather conditions that may interfere with safe flight and result in damage to the drone or other material damages [16]. Delivery risk is also an important factor affecting public acceptance of drones as a means of delivery. It refers to the probability that the drone might not be operable and/or might be unable to deliver the product [11]. With the application of appropriate safety measures and training, the risk of technical problems with drones in adverse weather conditions may be reduced to an acceptable level. This might increase further usage of drones in various fields, including logistics. In addition, drones have several other technological disadvantages, such as difficulties in avoiding obstacles such as buildings, structures, other drones, aircrafts, and birds [33], as well as low transport capacity [34].

## 3 Methodology

The fuzzy Delphi based fuzzy ANP method (fuzzy DANP) was used in this paper to solve the problem of prioritization. The first step of applying the method is defining the structure of the problem, that is, defining barriers and grouping them. For the problem defined in this way, an analysis is performed in order to determine the mutual influence of barriers and the strength of that influence. The analysis implies a comparison of all pairs of barriers from the perspective of different stakeholders. A linguistic scale was used for comparison, which can be converted into triangular fuzzy numbers shown in Table 1.

**Table 1.** Fuzzy scale for comparing elements

Linguistic term	Abbreviation	Fuzzy Scale
None	NI	(1, 1, 2)
Very low	VN	(1, 2, 3)
Low	N	(2, 3, 4)
Fairly low	UN	(3, 4, 5)
Medium	S	(4, 5, 6)
Fairly high	UV	(5, 6, 7)
High	V	(6, 7, 8)

Different evaluations of the stakeholders' representatives were combined using the following equations, which are part of the fuzzy Delphi method [35]:

$$\tilde{\delta}_{ij} = (\alpha_{ij}, \beta_{ij}, \gamma_{ij}) \quad (1)$$

$$\alpha_{ij} = \text{Min}(l_{ijl}), \quad l = 1, \dots, o \quad (2)$$

$$\beta_{ij} = \left( \prod_{l=1}^o m_{ijl} \right)^{1/o}, \quad l = 1, \dots, o \quad (3)$$

$$\gamma_{ij} = \text{Max}(u_{ijl}), \quad l = 1, \dots, o \quad (4)$$

where  $\alpha_{ij}, \beta_{ij}$  and  $\gamma_{ij}$  are the lower, middle and upper values of the unified fuzzy evaluation  $\tilde{\delta}_{ij}$ , respectively, and  $\alpha_{ij} \leq \beta_{ij} \leq \gamma_{ij}$ .  $l_{ijl}, m_{ijl}$  and  $r_{ijl}$  are the lower, middle and upper values of the triangular fuzzy evaluation  $\tilde{a}_{ijl}$  which implies the significance of the element (barrier)  $i$  in relation to the element  $j$  from the stakeholder  $l$  point of view.  $o$  is the number of stakeholders' representatives who made the evaluations.

By applying the relations (1)-(4), unified evaluations of the pair-wise comparisons are obtained, based on which fuzzy decision matrices  $\tilde{\Delta}$  are formed in the following way:

$$\tilde{\Delta} = \begin{bmatrix} / & \tilde{\delta}_{12} & \dots & \tilde{\delta}_{1n} \\ \tilde{\delta}_{21} & / & \dots & \tilde{\delta}_{2n} \\ \vdots & \vdots & \ddots & \vdots \\ \tilde{\delta}_{n1} & \tilde{\delta}_{n2} & \dots & / \end{bmatrix} \quad (5)$$

For each pair wise comparison matrix, it is necessary to obtain the priority vector in order to form different sub-matrices of the supermatrix. The priority vector from the fuzzy matrix  $\tilde{\Delta}$  can be obtained in various ways. This paper uses "logarithmic fuzzy preference programming" (LFPP) method [36] which approximates the fuzzy value  $\tilde{\delta}_{ij}$  from the matrix  $\tilde{\Delta}$  by the relation:

$$\ln \tilde{\delta}_{ij} \approx (\ln l_{ij}, \ln m_{ij}, \ln r_{ij}), \quad i, j = 1, 2, \dots, n \quad (6)$$

To determine the priority value of the elements ( $w_i$ ), it is necessary to solve the following non-linear priority model:

$$\begin{aligned} \text{Min } J &= (1-\lambda)^2 + M \cdot \sum_{i=1}^{n-1} \sum_{j=i+1}^n (\varepsilon_{ij}^2 + \eta_{ij}^2) \\ \text{s.t. } &\begin{cases} x_i - x_j - \lambda \ln(m_{ij}/l_{ij}) + \varepsilon_{ij} \geq \ln l_{ij}, \\ \quad i = 1, \dots, n-1; j = i+1, \dots, n, \\ -x_i + x_j - \lambda \ln(r_{ij}/m_{ij}) + \eta_{ij} \geq -\ln r_{ij}, \\ \quad i = 1, \dots, n-1; j = i+1, \dots, n, \\ \lambda, x_i \geq 0, i = 1, \dots, n, \\ \varepsilon_{ij}, \eta_{ij} \geq 0, i = 1, \dots, n-1; j = i+1, \dots, n, \end{cases} \end{aligned} \quad (7)$$

where  $x_i = \ln w_i$  for  $i = 1, \dots, n$ , and  $M$  is a constant of sufficiently large value such as  $M = 10^3$ .  $\varepsilon_{ij}$  and  $\eta_{ij}$  for  $i = 1, \dots, n-1$  and  $j = 1, \dots, n$  are non-negative variable deviations that are introduced to prevent  $\lambda$  from taking a negative value. It is desirable that the values of the variable deviations be as small as possible, and the following inequalities must be fulfilled:

$$\ln w_i - \ln w_j - \lambda \ln(m_{ij}/l_{ij}) + \varepsilon_{ij} \geq \ln l_{ij},$$

$$i = 1, \dots, n-1; j = i+1, \dots, n,$$

$$-\ln w_i + \ln w_j - \lambda \ln(r_{ij}/m_{ij}) + \eta_{ij} \geq -\ln r_{ij},$$

$$i = 1, \dots, n-1; j = i+1, \dots, n.$$

Let  $x_i^* (i = 1, \dots, n)$  be the optimal solution of the model (7). Normalized values for the fuzzy comparison matrix  $\tilde{\Delta} = (\tilde{\delta}_{ij})_{n \times n}$  are obtained as:

$$w_i^* = \frac{\exp(x_i^*)}{\sum_{j=1}^n \exp(x_j^*)}, \quad i = 1, \dots, n, \quad (8)$$

where  $\exp()$  is an exponential function, that is,  $\exp(x_i^*) = e^{x_i^*}$  za  $i = 1, \dots, n$ .

In order to control the results of the method, it is necessary to calculate the Consistency Ratio (CR) for each matrix and the overall inconsistency of the hierarchical structure.

Form the initial super-matrix whose elements are the optimal solutions of the nonlinear model (7) and obtain the limit super-matrix. By raising the initial super-matrix to the power of  $2p + 1$ , where  $p$  is a sufficiently large number, the matrix converges, that is, the values in the rows of the matrix converge to the same values for each column of the matrix [37]. The newly obtained matrix is called the limit super-matrix.

## 4 Solution of the problem

The barriers described in section 3 were evaluated by members of different stakeholders: service providers, service users, residents and city administration. Stakeholders' representatives compared all pairs of barriers, both within groups and between groups, thus establishing internal and external dependencies of barriers. The importance of the mutual influence of barriers was evaluated using linguistic evaluations that can be transformed into triangular fuzzy numbers using the relations given in Table 1.

By applying equations (1) - (4), the transformed fuzzy ratings are combined, thus forming fuzzy comparison matrices. By solving the nonlinear priority model (7) for each of the matrices, the weights of the elements (barriers) were obtained, from which the initial super-matrix was formed. This matrix was then raised to the  $2p + 1$  power to obtain a limit super-matrix. These values are adopted as weights (importance) of the observed barriers. The obtained results are shown in Table 2.

**Table 2.** Results of evaluation of obstacles using the fuzzy DANP method

Barrier	Weight (significance)	Barrier	Weight (significance)
En1	0.007	Ec1	0.032
En2	0.042	Ec2	0.037
En3	0.029	Ec3	0.002
En4	0.012	Ec4	0.005
Pp1	0.049	Te1	0.047
Pp2	0.042	Te2	0.034
Pp3	0.008	Te3	0.006
Pp4	0.029	Te4	0.057
Pp5	0.034	Te5	0.064
Pp6	0.015	Te6	0.005
Pp7	0.020	Ps1	0.022
Rl1	0.058	Ps2	0.021
Rl2	0.024	Ps3	0.022
Rl3	0.010	Ps4	0.012
Rl4	0.019	Ps5	0.020
Rl5	0.031	Ps6	0.032
Rl6	0.037	Ps7	0.027
Rl7	0.069	Ps8	0.023

Based on the obtained results, it may be recognized that the lack of aviation regulations, drone tracking, drone owners' liability and obstacle and collision avoidance are of the most crucial importance. They are followed by the

problems such as higher perceived risk and short flight range. From the perspective of a group of barriers, technical barriers, legislation and regulations are of the highest priority.

Non-compliance of aviation and other regulations with new technologies and innovations may lead to uncertainty regarding the legal framework and make it challenging to plan and implement an effective strategy for the implementation of drones. The lack of aviation regulation may also lead to disparate market conditions between companies that use drones and those that do not, which may affect competitiveness and innovation.

## 5 Conclusion

The popularity of drones is increasing in the general public as well as in science. However, the uncertainty of their future application is also increasing. This study uses the fuzzy Delphi ANP method (fuzzy DANP) to resolve the issues of prioritizing the barriers for the application of drones in LML. The analysis of barriers to the implementation of drones in LM is evaluated from different perspectives and interests of different stakeholders, which represents a new approach compared to previous research in this field.

The results indicate that the most critical barriers to the implementation of drones in LM are lack of aviation regulations, drone tracking, drone owners' liability and obstacle and collision avoidance. They are followed by higher perceived risk and short flight range.

Overall, based on the groups of barriers, the study concludes that legislation and regulations, as well as technical issues, are the most critical barriers to drone implementation. Public acceptance and psychological perception and environmental issues are medium critical. Privacy and security and economic aspect are the least critical barriers identified. Therefore, due to the lack of regulations and legislation, the possibilities of a large-scale usage of drones in LML are currently small. For future research, the same analysis may be performed with additional barriers identified with the development of drone technology and its commercialization.

## References

- [1] S. Tadić, S. Zečević, *Modeling the city logistics concepts* (in Serbian), Belgrade, Serbia, Faculty of Transport and Traffic Engineering, University of Belgrade, 2016.
- [2] S. Tadić, M. Krstić, M. Kovač, N. Brnjac, "Smart solutions for the problems of city logistics", *19th European Transport Congress: European Green Deal Challenges and Solutions for Mobility and Logistics in Cities*, Maribor, Slovenia, 2021
- [3] S. Tadić, S. Zečević, J. Petrović-Vujačić, "Global trends and development of logistics" (in Serbian), *Ekonomski vidici*, vol. 18, no. 4, pp. 519-532, 2013.
- [4] J. Olsson, D. Hellström, H. Pålsson, "Framework of Last Mile Logistics Research: A Systematic Review of the Literature", *Sustainability*, vol. 11, no. 24, pp. 7131, 2019
- [5] R. Gevaers, E. Van de Voorde, T. Vanelander, "Characteristics of innovations in last mile logistics-using best practices, case studies and making the link with green and sustainable logistics", *Association for European Transport and contributors*, vol. 1, pp. 1-21, 2009.
- [6] F. Borghetti, C. Caballini, A. Carboni, G. Grossato, R. Maja, B. Barabino, "The Use of Drones for Last-Mile Delivery: A Numerical Case Study in Milan, Italy", *Sustainability*, vol. 14, no. 3, pp. 1766, 2022.
- [7] S. A. Voccia, A. M. Campbell, B. W. Thomas, "The Same-Day Delivery Problem for Online Purchases", *Transportation Science*, vol. 13, pp. 167-184, 2019.
- [8] Y. Vakulenko, P. Shams, D. Hellström, K. Hjort, "Service Innovation in E-Commerce Last Mile Delivery: Mapping the E-Customer Journey", *Journal of Business Research*, vol. 101, pp. 461-468, 2019.
- [9] R. Khan, S. Tausif, A. Javed Malik, "Consumer Acceptance of Delivery Drones in Urban Areas", *International Journal of Consumer Studies*, vol. 43, no. 1, pp. 87-101, 2019.
- [10] C. Chen, F. Demir, Y. Huang, R. Qiu, "The adoption of self-driving delivery robots in last mile logistics", *Transportation Research Part E: Logistics and Transportation Review*, vol. 146, no. 102214, 2021.
- [11] W. Yoo, E. Yu, J. Jung, "Drone Delivery: Factors Affecting the Public's Attitude and Intention to Adopt", *Telematics and Informatics*, vol. 35, pp. 1687-1700, 2018.
- [12] B. Sah, R. Gupta, D. Bani-Hani, "Analysis of barriers to implement drone logistics", *International Journal of Logistics Research and Applications*, vol. 24, no. 6, pp. 531-550, 2020.
- [13] V. Chang, P. Chundury, M. Chetty, "Spiders in the Sky: User Perceptions of Drones, Privacy, and Security." *In Proceedings of the 2017 CHI Conference on Human Factors in Computing Systems*, pp. 6765–6776. ACM 2017.
- [14] C. Bracken, R. D. Lyon, M. J. Mansour, A. Molnar, A. Saulnier, S. Thompson, G. Adams, M. Masoodi, J. Sharpe, "Surveillance Drones: Privacy Implications of the Spread of Unmanned Aerial Vehicles (UAVs) in Canada.", *Surveillance Studies Centre*: Queen's University, Kingston, UK, 30. 2014.
- [15] A. Sanjab, W. Saad, T. Basar, "Prospect Theory for Enhanced Cyber-Physical Security of Drone Delivery Systems: A Network Interdiction Game", *2017 IEEE international conference on communications (ICC)*, IEEE, 2017, pp. 1-6.
- [16] H. Kwon, J. Kim, Y. Park. "Applying LSA Text Mining Technique in Envisioning Social Impacts of Emerging Technologies: The Case of Drone Technology", *Technovation*, vol. 60, pp 15-28, 2017.
- [17] J. Buko, M. Bulsa, A. Makowski, "Spatial premises and key conditions for the use of UAVs for delivery of items on the example of the polish courier and postal services market" *Energies*, vol.15, no, pp. 1403. 2022.
- [18] R. Merkert, J. Bushell, "Managing the drone revolution: A systematic literature review into the current use of airborne drones and future strategic directions for their effective control", *Journal of Air Transport Management*, vol. 89, pp. 101929, 2020.
- [19] C. Sandbrook, "The Social Implications of Using Drones for Biodiversity Conservation", *Ambio*, vol. 44, pp. 636–647, 2015.
- [20] R. Kellermann, T. Biehle, L. Fischer, "Drones for parcel and passenger transportation: A literature review. *Transportation Research Interdisciplinary Perspectives*, vol 4, pp. 100088, 2020.
- [21] A. P. Cohen, S. A. Shaheen, E. M. Farrar, "Urban air mobility: History, ecosystem, market potential, and challenges", *IEEE Transactions on Intelligent Transportation Systems*, vol. 22, no. 9, pp. 6074-6087, 2021.
- [22] T. M. Ravich, "Commercial Drones and the Phantom Menace", *Journal of International Media & Entertainment Law*, vol. 5, no. 175, pp. 1-35, 2013.
- [23] H. J. Park, R. Mirjalili, M. J. Côté, G. J. Lim, "Scheduling diagnostic testing kit deliveries with the mothership and drone routing problem",

- Journal of Intelligent & Robotic Systems*, vol 105, no. 2, pp. 1-19, 2022.
- [24] K. Kuru, "Planning the future of smart cities with swarms of fully autonomous drones using a new framework", *IEEE Access*, vol. 9, pp 6571–6595, 2021.
- [25] R. Kapoor, N. Cloet, A. Gardi, A. Mohamed, R. Sabatini, "Sound propagation modeling for manned and unmanned aircraft noise assessment and mitigation: A review", *Atmosfera*, vol. 12, pp. 1424, 2021.
- [26] A J. Toria, C. Clark, "A psychoacoustic approach to building knowledge about the human response to drone noise", *International Journal of Environmental Research and Public Health*, vol 18, no. 2, pp. 682, 2021
- [27] J. K. Stolaroff, C. Samaras, E. R. O'Neill, A. Lubers, A. S. Mitchell, D. Ceperley, "Life-cycle energy use and greenhouse gas emissions of commercial package delivery drones", *Nature Communications*, vol 9, pp. 409, 2018.
- [28] A. Goodchild, J. Toy, "Delivery by Drone: An Evaluation of Unmanned Aerial Vehicle Technology in Reducing co2 Emissions in the Delivery Service Industry", *Transportation Research Part D: Transport and Environment*, vol. 61 pp. 58–67, 2018.
- [29] A. J. Toria, Z. Li, "Self, RH Effects of flying drone on urban soundscape perception", *Transportation Research Part D: Transport and Environment*, vol. 78, pp. 102195, 2020.
- [30] S. S. Ahmed, K. F. Hulme, G. Fountas, U. Eker, I. V. Benedyk, S. E. Still, P. C. Anastasopoulos, "The flying car—challenges and strategies for future adoption", *Frontiers in Built Environment*, vol. 6, pp 1–11, 2020.
- [31] E. Çetin, A. Cano, R. Deransy, S. Tres, C. Barrado, "Implementing mitigation to improve social acceptance of urban air mobility", *Drones*, vol. 6, no. 2, pp. 28, 2022
- [32] N. Agatz, P. Bouman, M. Schmidt, "Optimization Approaches for the Traveling Salesman Problem with Drone", *Transportation Science*, vol. 52, no. 4, pp. 965–981, 2018.
- [33] P. E. Ross, "Open-source Drones for fun and Profit", *IEEE Spectrum*, vol. 51, no. 3, pp. 54–59, 2014.
- [34] N. Hallermann, G. Morgenthal, "Unmanned Aerial Vehicles (UAV) for the Assessment of Existing Structures", *In IABSE Symposium Report*, vol. 101, pp. 1–8, 2013.
- [35] R. Mikaeil, Y. Ozcelik, R. Yousefi, M. Ataei, S. M. Hosseini, "Ranking the sawability of ornamental stone using Fuzzy Delphi and multi-criteria decision-making techniques", *International Journal of Rock Mechanics & Mining Sciences*, vol. 58, pp. 118-126, 2013.
- [36] Y. M. Wang, K. S. Chin, "Fuzzy analytic hierarchy process: A logarithmic fuzzy preference programming methodology", *International Journal of Approximate Reasoning*, vol. 52, pp. 541–553, 2011.
- [37] B. K. Lee, K. H. Kim, "Optimizing the yard layout in container terminals", *OR Spectrum*, vol 35, pp. 363–398, 2013.



# Cloud computing architecture for evaluating courier driving capability in express courier services

Gordana Jotanović<sup>1</sup>, Goran Jauševac<sup>1</sup>, Dragan Peraković<sup>2</sup>, Miroslav Kostadinović<sup>1</sup>, Branko Jotanović<sup>3</sup>

<sup>1</sup>University of East Sarajevo, Faculty of Transport and Traffic Engineering, Vojvode Misica 52, 74000 Doboj, Bosnia and Herzegovina

<sup>2</sup>University of Zagreb, Faculty of Transport and Traffic Sciences, Borongajska cesta 83a, 10000 Zagreb, Croatia

<sup>3</sup>X Express, Courier Service, Branka Perduva 10A, 78000 Banja Luka, Bosnia and Herzegovina

## Abstract

The Cloud Computing System presented in the paper deals with the assessment of the possibility of safe courier driving in express courier services. Express courier services strive to ensure delivery with as few losses as possible with maximum efficiency of the courier delivery. The proposed system is based on Cloud Computing architecture, and is intended for evaluating the possibility of courier driving. The most important part of the system is the evaluation of the courier's current driving capabilities based on eye parameters. Using pupil/iris parameter sizes, the system recognizes unusual conditions of the courier's eye. Detected unusual conditions of the courier's eye can indicate the potential use of narcotics, medications, fatigue, depressive states, etc. The Cloud Computing System is tasked with real-time assessment of the courier's ability to drive the vehicle and based on that assessment makes recommendations. Recommendations are sent to the Supervisor of the Logistics Center and can range from a simple warning, a request to temporarily disconnect the driver from the vehicle, to a recommendation to completely disconnect the driver from the vehicle for a long time.

**Keywords:** *Courier; Express courier services; Courier driving capability; Cloud Computing System, Courier Services System.*

## 1 Introduction

Globalization in the world, technology development and ubiquitous computerization generate new challenges that express courier services must face. Service providers must not only continuously react, adapting to market expectations, but also take proactive measures [1].

One of the biggest recorded problems within courier services is damage caused by couriers while driving. Couriers mostly cause damage to vehicles and goods being delivered by their own carelessness, lack of training and current driving capabilities. The carelessness of the courier happens at a certain moment, so it is not always completely controlled by the driver and it is difficult to eliminate it. Lack of training is strictly controlled and can be remedied through additional courier driver training. The most interesting topic

to consider is current driving capabilities that can be avoided by eliminating couriers from the delivery system. The evaluation of the courier's current driving abilities can be made based on the recognition of deviant conditions of the driver's eye. As part of the assessment, the narrowing or expansion of the pupil/iris can be monitored when drivers take drugs, drink alcohol, consume certain types of medication, are tired, depressed, etc. The goal of this research is to create a Cloud Computing System that evaluates the courier's current ability to drive. The results of the assessment could be used in terms of sanctioning couriers by excluding them from traffic, and thus protecting people and goods. The system presented in this paper is used to assess the current driving abilities of professional drivers. Couriers are drivers of trucks, vans, cars who transport goods. They are also responsible for taking care

---

Corresponding author: *Gordana Jotanovic (gordana.jotanovic@sf.ues.rs.ba)*



of their vehicle, cargo during transport. Often, the safety of people and goods depends on the immediate ability of the courier to drive the vehicle. Therefore, there is a need to test the current driving capabilities of couriers in express courier services on a daily basis. Employers of transport companies strive for the maximum efficiency of couriers in their work, in order to ensure the safe transport of goods. Therefore, the current ability to drive vehicles is of great importance for people's life and work.

The paper is structured as follows: the first part contains an introduction to the issue. The second part deals with thematic considerations in courier driving possibilities. The third part describes the system for assessing the courier's current ability to drive a vehicle. The fourth part refers to the Cloud Computing System for evaluating courier driving capabilities. The fifth section deals with the results and the discussion of the presented results. Concluding remarks and future research developments are presented in the sixth section.

## **2 Courier driving capability in express courier services**

Traffic accidents with unfavorable outcomes and material damage are a frequent occurrence in the Courier Services System [2–4]. Traffic accidents in express courier services are mostly caused by drivers (couriers). In order to reduce material damage to delivery vehicles and goods, and reduce delivery time, express courier services must improve the knowledge and skills of couriers. However, traffic accidents are not only the result not of the courier's training but of the courier's current condition. It is very difficult to recognize courier driving capabilities at the moment of picking up the delivery vehicle. Recognizing hard-to-predict courier driving conditions can save many lives, reduce material damage, and improve the operation of express courier services.

### **2.1 Courier driving capability under the influence of alcohol**

One of the methods of assessing the driving capabilities under the influence of alcohol is based on the recognition of deviant conditions of the driver's eye [5–7]. Practical experience shows that eye damage occurs even with minor alcohol

consumption. When alcoholism becomes chronic, vision problems worsen:

- Reduced visual perception of the environment. The brain is responsible for the organs of vision, and alcohol gives it a big blow. The main symptoms of the pathology are blurred vision, split image, slowing of visual reaction.
- When alcohol enters the body, the driver begins to react more slowly to light, the pupil of the eye expands.
- The quality of peripheral vision is reduced. Prolonged drinking of alcohol leads to a decrease in sensitivity.
- Dilated pupils perceive contrast less well.
- A person suffering from alcoholism is more likely to undergo optic neuropathy. In the presence of this pathology, vision is often lost, the perception of the color of the environment decreases.
- Frequent migraines are possible.

From the above, we can conclude that the influence of alcohol on a person's vision significantly reduces functionality in everyday life [8].

### **2.2 Courier driving capability under the influence of medicines and narcotics**

Without a deeper analysis, it is difficult to recognize a delivery courier who is under the influence of medication and drugs, but the aforementioned influences can have bad consequences for the courier's driving capabilities. The content of drugs and some types of medication relaxes you, usually makes a person happy or alert, however it not only manipulates neurotransmitters in your brain, but can also affect physiological processes in your body. They also include the eye muscles that are responsible for dilating or constricting your pupils [9]. After using cocaine, marijuana, or amphetamines, your pupils are noticeably wider, while drugs like heroin will cause your pupils to constrict [10].

A change in the size of the pupils does not always have to be a sign of drug consumption. Pupils can be dilated if a person has epilepsy and takes medication, is scared or tired. Regardless of whether the driver is a drug user, a drunk person, a person who has epilepsy or is taking medication, for the safety of other people, it is necessary to exclude such persons from traffic.

### 3 Assessment of the current driving capability of courier

The paper is based on the development of a Cloud Computing System for assessing the current ability of couriers to drive a delivery vehicle. The most important part of the system is the assessment of the current driving capabilities of the courier based on eye parameters from the courier's image [11]. The system detects 2 areas of the eye (iris/pupil) [12]. Recognition is done using the geometric properties of the eye [13]. The success of recognizing the iris/pupil of the eye based on the courier image depends on: the quality of the courier image, the angle of the courier's eye (open/semi-open) and (front side/corner), and the lighting regime at the time of image formation and other factors [14].

Based on the comparison of the relationship between the iris and the pupil from the real-time image of the courier and the image of the same courier taken from a previously formed data set of all employed couriers, the system provides an estimate of the courier's current driving ability.

The result of the assessment is a text message that is forwarded to the dispatch center to the Supervisor and can read "The courier is able to drive the vehicle" and "The courier is not able to drive the vehicle". The assessment of the courier's current ability to drive a vehicle may be wrong if the driver was under the influence of alcohol, narcotics, prohibited drugs, etc. during the first photo shoot.

Lack of judgment can be avoided by paying attention to the courier's behavior before taking the first photo.

### 4 Cloud Computing System for evaluating courier driving capability

The Cloud Computing System (CCS) can serve several logistics centers at the same time. CCS is intended for data collection and processing. The assessment of the courier's ability to drive is carried out for each courier individually within the framework of CCS. Data collection, i.e. the initial photographing of the courier at the time of reporting for duty, is carried out in the logistics center to which the courier belongs (Figure 1).

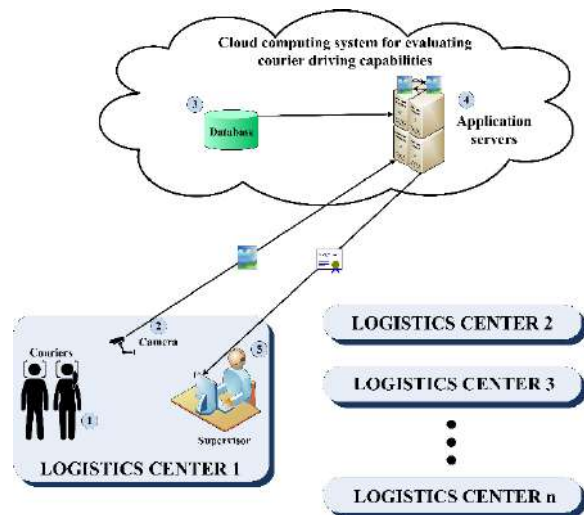

Fig. 1. Cloud computing architecture for evaluating courier driving capability

The CCS system consists of the following elements:

1. Couriers reporting to work at Logistics Center 1.
2. The camera used to photograph the courier at the time of reporting for duty.
3. Database of Initial Images of couriers from all logistics centers at the time of employment.
4. The application server is responsible for processing incoming images, processing and evaluating courier driving capabilities.
5. The supervisor, on the basis of evaluating courier driving capabilities, makes a decision to exclude the courier from the delivery system.

Within the logistics center, couriers are photographed when reporting for duty (Initial Images). Initial courier images taken according to special conditions, shooting angle, lighting, etc. they are sent for processing to the Application Server located in the cloud. Processed Initial Images of couriers are compared with images of couriers taken at the time of their employment. The aim of the comparison is to detect deviant states of the courier based on eye parameters (iris/pupil). As soon as the deviant condition of the courier is observed, the information is sent to the Supervisor, who decides on the exclusion of the courier from traffic.

### 5 Results and Discussion

In order to determine the validity of the CCS system, a prototype model for the object-oriented process was created (Figure 2).



other use. The validity of the CCS system was tested by designing a prototype model for an object-oriented process. The system recognizes the parameters of the pupil/iris of the eye from an Initial Image, which is a big advantage compared to other similar systems. The disadvantage of the system is that the image must be taken under predetermined conditions, and therefore the image must be taken in a specific place and at a precisely defined angle and lighting. Based on the size of the pupil/iris parameters, the system recognizes unusual conditions of the courier's eye that suggest to the Supervisor that the courier should be excluded from traffic. Also, the system can evaluate the driving skills of couriers in several logistics centers at the same time.

In future research, the Cloud Computing System can use a neural network to detect deviant courier states. A neural network could perform an automatic classification of deviant states of couriers with the possibility of giving a prediction for the exclusion from traffic.

Also, CCS could be improved so that iris/pupil detection results can be applied in eye tracking systems that use biometric systems. Based on this, a fast and accurate system for real use would be created, which would be based on a hardware-software platform that would be used for that purpose. One of the roles of such a system could be to assess the delivery courier's ability during the entire delivery route, and not only at the starting point of the route when the courier starts driving. The CCS would be tasked with real-time assessment of the driver's ability to operate the vehicle and based on that assessment make recommendations. Recommendations sent to the Supervisor of the Logistics Center can range from a simple warning, a request to temporarily disconnect the driver from the vehicle, to a recommendation to completely disconnect the driver from the vehicle for a long time.

## References

- [1.] Ł. Sułkowski, K. Kolasińska-Morawska, M. Brzozowska, P. Morawski, T. Schroeder: Last Mile Logistics Innovations in the Courier-Express-Parcel Sector Due to the COVID-19 Pandemic. *Sustainability*. 14, 8207 (2022).
- [2.] E. Žunić, A. Djedović, D. Đonko: Cluster-based analysis and time-series prediction model for reducing the number of traffic accidents. *Presented at the 2017 International Symposium ELMAR* (2017).
- [3.] G. Jauševac, Ž. Stojanov: Software tools for the reconstruction of traffic accidents: A preliminary review. In: *Proceedings of international conference on applied internet and information technologies*. University of Novi Sad, Technical Faculty "Mihajlo Pupin", Zrenjanin (2015), pp. 165–169.
- [4.] M. Koornstra, A. Evans, C. Glansdorp, NO Jørgensen, I. van Schagen: Transport Accident Costs and the Value of Safety. *European Transport Safety Council* (1997).
- [5.] R. P. Wildes, J. C. Asmuth, G. L. Green, S. C. Hsu, R. J. Kolczynski, J. R. Matey, S. E. McBride: A machine-vision system for iris recognition. *Machine vision and Applications*. 9, (1996) pp.1–8.
- [6.] D. Zadnik, A. Žemva: Image Acquisition Device for Smart-City Access Control Applications Based on Iris Recognition. *Sensors*. 21, 6185 (2021).
- [7.] M. K. Eckstein, B. Guerra-Carrillo, A. T. Miller Singley, S. A. Bunge: Beyond eye gaze: What else can eyetracking reveal about cognition and cognitive development? *Developmental Cognitive Neuroscience*. 25, (2017), pp. 69–91.  
<https://doi.org/10.1016/j.dcn.2016.11.001>
- [8.] O Viziji I Zdravlje Očiju - 2023, <https://www.intracoastaleyecare.com/>.
- [9.] S. Usui, Y. Hirata,: Estimation of autonomic nervous activity using the inverse dynamic model of the pupil muscle plant. *Annals of Biomedical Engineering*. 23, (1995), pp.375–387, <https://doi.org/10.1007/BF02584438>.

- [10.] S. Kawai, H. Takano, K. Nakamura: Pupil Diameter Variation in Positive and Negative Emotions with Visual Stimulus. In: *2013 IEEE International Conference on Systems, Man, and Cybernetics*. (2013), pp. 4179–4183.
- [11.] G. Jotanović, Ž. Stojanov, D. Peraković, A. Kosovac, A. Damjanović: Algorithm for assessing the current driver's ability to drive a vehicle based on eye parameter recognition. Presented at the *VIII International Symposium New Horizons 2021 of Transport and Communications*, Doboj (2021).
- [12.] J. Daugman: Chapter 25 - How Iris Recognition Works. In: Al Bovik (ed.) *The Essential Guide to Image Processing*. pp. 715–739. *Academic Press*, Boston (2009).
- [13.] H.A.S. Mohammad, S. Sameer, M, M.E. Ragab: A survey on Hough transform, theory, techniques and applications. *arXiv preprint arXiv:1502.02160*. (2015).
- [14.] G. Jotanović, G. Jauševac, M. Kostadinović, A. Damjanović, V. Brtko: Eye Detection Model for Assessing the Working Capacities of Employees. In: *2021 20th International Symposium INFOTEH-JAHORINA (INFOTEH)*. (2021), pp. 1–5.

# Impact of micro mobility on curb management and city logistic sustainability

Stevan Veličković, Biljana Grgurović, Jelena Milutinović, Slavica Radosavljević

Department School of Information and Communication Technologies, Academy of Technical and Art Applied Studies, Z. Celara 16, Belgrade11000, Serbia

## Abstract

The goal of sustainability is reflected in the cooperation between suppliers, users and public administration. Micromobility represents a new ecological approach to transport and sustainable traffic. It is the result of an increase in the number of vehicles in cities, large traffic jams, an increase in carbon dioxide emissions, need for better mobility etc. The appearance of the concept of micromobility puts the mobility of citizens and the use of green means of transport in the city center in focus. The concept gains even more importance by applying the principle of shared resources, the so-called shared micromobility. The increase in micromobility, but also a increase in number of small city deliveries, need for sustainable traffic, reduction in noise and better utilisation of parking spaces, affects the need to redefine the curb management. In this way, city roads are redefined and individual mobility is increased, which is of great importance for cities that generate a large part of their income from tourism. Citizens, local entrepreneurs, private courier operators, but also the city as a whole benefit from the curb management and shared micromobility.

**Keywords:** *City logistics, sustainability, micro mobility, curb management, shared economy.*

## 1. Introduction

With the increase in the urban population, there is also an increase in traffic congestion, which in turn leads to an increase in noise levels and an increase in the amount of CO<sub>2</sub> emission.

In order to improve the quality of life in cities, many international organizations have focused their attention on sustainable development.

Micromobility represents a new philosophy of urban sustainable traffic directed towards the zero-emission trend. This type of transport offers greater flexibility, favorable economy and is city friendly. Considering their characteristics, using micromobility vehicles is often faster than driving.

In the first chapter, the goals of sustainable development are presented with references to the role of the postal sector in sustainable development. The challenges of urban logistics are presented in the second chapter, and the potential solution to those challenges, called micromobility, is presented in the third chapter.

The fourth chapter is devoted to curbside management and the next chapter presents the potential role of micromobility in the field of delivery. Finally, concluding remarks are given.

## 2. Sustainable development

The growth of the world's population and increased migrations have led to the rapid expansion of cities. The United Nations predicts that by 2050, two-thirds of humanity, or about 6.5 billion people, will live in cities [1].

The development of society should go in a direction that ensures social, economic and environmental sustainability.

Sustainable development implies the development of a society that meets human needs with available resources and at the same time does not endanger natural systems and the environment. It can be said that the concept of sustainable development is the most important modern strategy and philosophy of social

---

Corresponding author: *Author (stevan.velickovic@ict.edu.rs)*

© 2023 The Author(s). This work is licensed under a [Creative Commons Attribution 4.0 International License](https://creativecommons.org/licenses/by/4.0/).

development. In 2015, the United Nations adopted the Sustainable Development Goals (SDGs), whose basic idea is to stop poverty, protect and preserve the planet, and to insure that all people in the world live in peace and prosperity by the year 2030 [2].

There are seventeen SDGs defined by the UN. Goal number 11. is interesting from the aspect of city logistics because it reads: "*Make cities and human settlements inclusive, safe, resilient and sustainable*". Making cities sustainable means creating career and business opportunities, safe and affordable housing, and building resilient societies and economies. It involves investment in public transport, creating green public spaces, and improving urban planning and management in participatory and inclusive ways [2].

The European Union has already embarked on a transition towards a low-carbon economy that is climate neutral, resource-efficient and circular – while ensuring social equality and inclusiveness. The EU has also put the SDGs at the heart of its external action and has aligned all development activities with the UN 2030 Agenda [3].

Paris has been the first to set remarkable targets: zero diesel cars by 2024 and zero fossil fuel cars by 2030, with Mayor committing to green mobility and 1000 km of cycling lanes across the city with her "15-minute city" plan [4].

## 2.1 Sustainable development and the postal sector

Sustainable development is an important element of postal operations that contributes to an improvement of efficacy, development of new markets, and strengthening of the relationship with consumers [5].

The Universal Postal Union, , has a key role in achieving these goals through integration, innovation, and inclusion. One of the focuses of the postal sector, which is in line with the EU initiative leading to sustainability, is related to the circular economy.

The circular economy refers to the increased possibility of repeated usage of resources. It is a system that aims to reconcile economic growth with environmental protection, keeping in mind the limitation of resources. The emphasis is put on making resources last as long as possible through a product design that will enable longevity,

business models such as sharing, reusing, and repairing, and only eventually recycling [6].

## 3. Challenges of city logistics

A large number of residents and companies in cities are traffic and transport generators. Various criteria imposed by different type of users further complicates the implementation of city logistics. There is no single solution for solving logistical problems in urban areas.

We define urban logistics as that part of supply chain management that plans, implements, and controls the efficient, effective forward and reverse flow and storage of goods, services, and related information between the point of origin and point of consumption in order to meet customers requirements [7].

The increase in the city's population and the cumulative effect it has on both the economic structure of the city and the overall city infrastructure has brought into focus numerous problems, such as:

- Air quality - Air pollution levels exceed safe levels in many European cities, leading to premature deaths;
- Climate change - Transport is Europe's largest source of GHG emissions, contributing to 27% of the EU's total CO2 emissions;
- Noise - The EU estimates that 40% of Europeans are exposed to dangerous levels of road traffic-related noise, impacting mental health and well-being;
- Congestion - The average person living in Paris spends 65 hours in traffic per year, compared with 49 in Munich and 35 in Stockholm, leading to a loss of productivity. Reduced commuting time is a strong predictor of well-being and has been linked to poverty alleviation;
- Space - Research in Stockholm shows that 50% of the city's space is allocated to roads and car parking;[4]. This also means that there is: lack of attention directed towards the movement of cyclists and pedestrians; lack of inclusion for persons with special needs; lack of urban green zones etc.

As cities grow, so does the need for mobility, which is made possible by the appropriate traffic infrastructure. Increased awareness for environmental protection, sustainability and the

need for mobility led to a new traffic and transport solution that we know today as micromobility.

#### 4. Micromobility

According to the Institute for Transport and Development Policy, micromobility refers to a group of small, light vehicles whose operating speed is below 25 km/h and which are driven by the users themselves. This group of vehicles includes bicycles, e-bikes, electric scooters, electric skateboards, fleet of shared bikes as well as bikes with auxiliary electric drive [8].

According to the Merriam-Webster dictionary, micromobility is the "transportation over short distances provided by lightweight, usually single-person vehicles (such as bicycles and scooters)".

Micromobility vehicles can be powered by human power as well as by an electric motor. For electric vehicles to be classified as micromobility vehicles, they must not have an internal combustion engine or have a speed greater than 45 km/h [9].

Type A	Type B	Type C	Type D
unpowered or powered up to 25 km/h (16 mph)		powered with top speed between 25-45 km/h (16-28 mph)	
<35 kg (77 lb)	35 – 350 kg (77 – 770 lb)	<35 kg (77 lb)	35 – 350 kg (77 – 770 lb)

Fig. 1. Categories of micromobility vehicles proposed by International Transport Forum [10]

Micromobility offers solutions to many urban challenges:

- Mobility and efficiency - Above all, these vehicles offer users increased flexibility and freedom of movement.
- Reduction of traffic jams - The characteristics of these vehicles are such that users can move easily and quickly on city roads, whereby the effect of city traffic jams is much less felt than in the case of using standard vehicles.
- Air pollution - Since the vehicles are powered by the user's own power or by electric motors, these vehicles do not pollute the environment with exhaust gases.

- Noise level - Micromobility vehicles do not generate noise, which leads to an increase in the quality of life. Also, this feature, along with the fact that they are intended for low speeds, gives them the ability to move in zones that are not intended for motor vehicles.
- Space - Due to their small dimensions, these vehicles occupy a small part of the parking space compared to the parking space of a standard motor vehicle.
- Cost-effectiveness - In many countries, the use of electric vehicles is free, as the batteries can be recharged in predefined urban areas without additional costs.
- Practicality - Micromobility vehicles are suitable for short distances and represent an ideal solution if offered as a complement to the mass transport system in the form of shared micromobility. They are the bond between the first and last mile gap of public transit.
- Health - Indirectly these vehicles affect health because people spend less time behind the wheel or in public transport and more time in free movement on the open.

In the literature, micromobility vehicles are often classified as light electric vehicles (LEVs). (Electric bicycles, electric scooters, electric skateboards, electric unicycle, and onewheel) [11].

Legislation related to light electric vehicles varies from country to country. In most cases, the limiting factor is the maximum permissible speed, total weight of the vehicle and the maximum power output.

Governments worldwide are pushing for walking and cycling as the ideal option for short urban journeys and e-scooters are now opening new opportunities. Electric scooters experienced a monumental rise in popularity in 2018, primarily in the US, but also in major cities across Europe, Latin America and Asia [12].

Several factors dictate why micro-mobility has experienced such paramount success in the last year. The urban population has increased from 3.4 billion to 4.2 billion since 2008 and so has mobile phone ownership, growing from 1 in 100 people to 1 in 5 in the same time period. This means that all riders have a smartphone to locate, unlock and pay for the e-scooter directly within the app. Parallel to this, battery prices dropped by 86 percent between 2010 and 2016, making electric mobility solutions more affordable. Moreover, significant improvements to range mean that e-



scooters can cover 30 to 50 kilometers and can often be used for an entire day before needing to be recharged [12].

#### 4.1 Shared micromobility

Micromobility vehicles can be privately owned but can also be available within a shared mobility system. Shared micromobility is a type of transport based on the rental of micromobility vehicles for personal needs and for short-term transport within the city's urban zone.

As defined by the Society of Automotive Engineers, shared mobility is *the shared use of a vehicle, motorcycle, scooter, bicycle, or other travel mode. Shared mobility provides users with short-term access to one of these modes of travel as they are needed.* [13]

Shared mobility has the potential to create affordable, reliable, equitable and sustainable mobility options for everyone.

Within two years of the first service's launch by Bird, in Santa Monica, California, in September 2017, e-scooter sharing services have reached 626 cities across 53 countries [4].

### 5. Curbside management

The degree of urbanization, the development of traffic and transport infrastructure from the aspect of regulation and safety, as well as the city's logistics solutions should be directed towards:

- Citizens. Efficient mobility should be offered, as well as good traffic connections through a diverse mass transport system, a satisfactory number of parking spaces, mobility for both pedestrians and cyclists, an increased sense of safety in traffic, inclusion of people with special needs, etc.
- Business entities. Considering that they carry out economic and transport-logistics activities in densely populated urban areas, it is necessary to focus action on regulating the movement of delivery vehicles, enabling a sufficient number of zones for loading and unloading, securing locations for the construction of logistics centers satisfying the spatial and traffic restrictions, motivating the transition to hybrid vehicles, green vehicles through city and state subsidies.

Looking at city logistics, it can be concluded that the most valuable resource is space, which is limited. It is almost impossible to increase the size of the space, so one of the logical solutions is the repurposing of the space, considering all the restrictions and requirements set by the citizens, the businesses and the city government. This process is also known in the literature as curbside management. Demands for redefining the existing space, i.e., repurposing certain parts of roads, are on the rise. There are many reasons for this. With the growth of deliveries in cities, the need for reserved delivery areas is growing. It is similar with shared mobility services, which are on the rise and for which a reserved zone is necessary for the entry and exit of passengers. If we look at the area of micromobility, we are talking about zones where these vehicles will be parked, refilled, etc.

The challenge facing most of today's cities is how to make roads (intended for both passenger and commercial vehicles as well as cyclists and pedestrians) as safe, productive and efficient as possible.

Fehr & Peers has developed an index called the Curb Productivity Index. The purpose of this index is to calculate the amount of passenger activity, i.e., the number of people using the sidewalk per hour per defined length of sidewalk that represents the size of a typical parking space on the street [14].

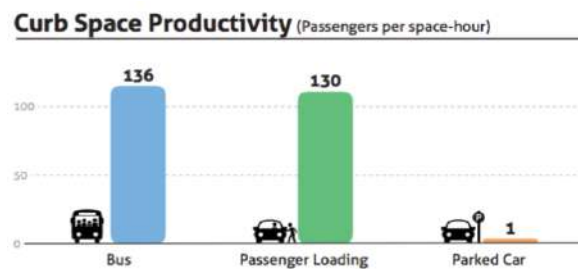

Fig. 2. Example of Curb space productivity [14]

This index shows the level of productivity for a certain type of vehicle or curbside space, which serves as a clear indicator for the necessity of repurposing the space.

Fehr & Peers has developed three broad strategies for improving curbside productivity and efficiency based on their observations and analysis:

- Relocation
- Conversion
- Flexibility.



*Fig. 3. Fehr & Peers strategies for improving productivity and efficiency of curb space [14]*

If current infrastructure in certain city zones, districts and even streets favor and leads to an increase in the number of deliveries, the use of bicycles, pedestrians or other micro-mobile vehicles, then the repurposing of space is imposed as a solution.

One of the (less popular) solutions is the repurposing of the parking spaces (intended for cars) to accommodate other modes of transportation that may be more in line with the goals of the urban area and the present community in terms of the environment, health and safety.

The conversion of space opens the possibility of urban and traffic planning aimed at the creation of zones for parking bicycles, LEV vehicles, parklets or aimed at mobility sharing vehicles and their pickup/drop off zones.

The growth of e-commerce has led to an increase in city deliveries. If we add to that the increase in the number of micromobility vehicles, urban planners and traffic engineers have a difficult task, which is reflected in the need to adapt parts of roads to the newly created traffic and transport requirements.

The increase in traffic congestion and at the same time the growth of people's awareness towards environmental protection represented an impulse towards new mobility solutions that were put into practical use with the development and improvement of technological innovations.

It is necessary to find a balance for all traffic participants, i.e., road users, both vehicles for individual and commercial use, as well as for pedestrians and users of micro-mobility means of transport.

The main objectives of curbside management are [15]:

- Traffic congestion management.
- Supporting economic activity.
- Meet stakeholder needs for various curbside functions while respecting corridor type and alignment with existing city plans and policies.

Practice has shown that the basic principles that should be followed when redefining the purpose of roads are [15]:

- Focus on mobility:
  - Manage general congestion.
  - Minimize curbside use on surface transit corridors.
  - Reduce curbside use at peak periods.
  - Encourage off-street curbside use.
- Secure and reliable access
  - The safety of road users is the most important.
  - The right of way has different roles at different times.
- Communicate Value to All
  - Simple solutions are preferred.
  - The curb is a scarce resource - user charges apply where appropriate.
  - Transparent and responsible decisions are necessary.

## 6. Micromobility and the last mile

From the commuter's point of view, the biggest challenge is the first and last mile, which we define as the space between the station and work, or the transfer between buses or any distance that is too close to drive, but too far to walk.

Micro-mobility is a solution to the last-mile problem. This typically encompasses all passenger trips of less than 8 kilometers, which accounts for up to 50 to 60 percent of passenger trips in urban spaces. These car trips, short public transport stretches and first and last-mile gaps can be replaced with bikes, electric scooters, mopeds and other micro-mobility solutions [12].

When talking about commercial aspect the last mile refers to the final step of the delivery process from a distribution center or facility to the end-user.

When looking at delivery in urban areas, the criterion of on-time delivery gains weight when considering the influence of narrow streets in the historic city center, remote residential areas as well as dense pedestrian areas.

One solution for delivery in urban areas is cargo bikes. They offer high flexibility, zero emission, they are easy to park and recharge and they gain more functionality with IT advance solution. With all that it said before, these means of transportation can offer users just-in-time delivery.

## 6.1 Micro-depots

The development of micro depots can be one of the solutions for improving delivery in cooperation with micromobility vehicles. Classic delivery involves vehicles that must follow a pre-defined route. In most cases, traffic jams or free parking spaces cannot be predicted, so it is difficult to accurately estimate the delivery time. Microdepots would serve the purpose of local depots with smaller delivery areas. Microdepots would be set up in areas of increased delivery. Micromobile vehicles would be an ideal solution for the last mile delivery with their flexibility, ease of parking and the ability to quickly reach any address.

In Berlin, five largest parcel delivery companies tested delivery by cargo bike for one year. They tested cooperative use of micro depots by the courier, express and parcel sector for the sustainable deployment of cargo bikes. The aim was to trial an alternative concept for urban delivery traffic. In mid-2019 the participating companies concluded that above all areas with a high drop density and suitable packages (number of items, volume and weight) were predestined for this approach. It requires suitable cooperative micro-depots in central locations [16].

## 7. Challenges of micromobility

In addition to numerous advantages, we must also be aware of numerous challenges that the use of micromobility vehicles brings with it. This primarily refers to:

- Safety - The development of technology, as well as the need for a small, light and economical form of transportation, led to their rapid acceptance and use of e-scooters and similar electric vehicles. As a result of the rapid expansion of these vehicles, there was a lack of regulation to ensure the safety of users. In addition, there is lack of clearly defined traffic zones for micromobility vehicles.
- Logistics - Like other vehicles, the efficiency of the use of micromobility vehicles depends on the supply chain, on responsiveness for maintenance, service, spare parts, as well as accompanying economic investments in the form of charging stations, vehicle storage, etc.
- Asset Regulation - In the case of micromobility, numerous legal issues arise regarding the ownership of assets in the chain of use (where to store vehicles when they are

not on the streets, where to park them, liability and insurance in case of theft, injuries, etc.).

- Communication - The issue of regulating communication through mobile applications. [17].

## 8. Conclusion

Logistic challenges in cities have led to an increase in noise, pollution and traffic congestion. Movement in cities is difficult so micromobility vehicles appear as a solution. They provide a flexible mode of transportation that is, in many cases, faster than driving. The increasing interest in sustainability puts micromobility vehicles in focus, given that they are environmentally friendly and with zero emission.

Micromobility vehicles offer numerous advantages for both citizens and businesses. The development of technology largely affects the expansion of these vehicles. Lower battery prices and increased capacity enable greater vehicle autonomy, and development of mobile application makes renting, paying, finding parking areas and charging easier, which contributes to the popularity of shared mobility.

We expect to see increased application of these vehicles in the field of delivery because they enable greater mobility in urban areas and do not require large parking spaces. Micromobility represents a new ecological approach to transport and sustainable traffic.

## 9. References

- [1] United Nations and S. A. P. D. Department of Economic, "World Urbanization Prospects The 2018 Revision," 2018.
- [2] United Nations: Department of Economic and Social Affairs Sustainable Development, "Transforming Our World: The 2030 Agenda for Sustainable Development," 2015.
- [3] European Commission, "A Green Deal Industrial Plan for the Net-Zero Age," Brussels, 2023.
- [4] Thomas Holm Møller and John Simlett, "Micromobility: moving cities into a sustainable future," 2020. Accessed: Apr. 27, 2023. [Online]. Available: [https://assets.ey.com/content/dam/ey-sites/ey-com/en\\_gl/topics/automotive-and-transportation/automotive-transportation-pdfs/ey-micromobility-moving-cities-into-a-sustainable-future.pdf](https://assets.ey.com/content/dam/ey-sites/ey-com/en_gl/topics/automotive-and-transportation/automotive-transportation-pdfs/ey-micromobility-moving-cities-into-a-sustainable-future.pdf)

- [5] Milutinovic J., Grgurovic B., Velickovic S., and Radosavljevic S., "The Development of the Concept of Consolidation Centers in Using the Sharing Economy in Postal Services / Logistics, I," in *International Conference on Advances in Traffic and Communication Technologies – ATCT 2022*, Sarajevo: University of Sarajevo, Faculty of Traffic and Communications, May 2022, pp. 85–91.
- [6] Tepić J., Tanackov I., Stojić G., and Sremac S., *Transportno-logističke osobine i tokovi robe*. Novi Sad: FTN Izdavaštvo, 2013.
- [7] W. J. Rose, J. E. Bell, C. W. Autry, and C. R. Cherry, "Urban logistics: Establishing key concepts and building a conceptual framework for future research," *Transportation Journal*, vol. 56, no. 4, pp. 357–394, 2017, doi: 10.5325/transportationj.56.4.0357.
- [8] D. Yanocha, M. Allan, V. Krishna, S. Bakker, J. F. Lyft, and S. Goodwillie, "The Electric Assist: Leveraging E-bikes and E-scooters for More Livable Cities," 2019. [Online]. Available: [www.itdp.org](http://www.itdp.org)
- [9] S. O’hern and N. Estgfaeller, "A scientometric review of powered micromobility," *Sustainability (Switzerland)*, vol. 12, no. 22, pp. 1–21, Nov. 2020, doi: 10.3390/su12229505.
- [10] Corporate Partnership Board, "Safe Micromobility," Paris, 2020. Accessed: Apr. 28, 2023. [Online]. Available: <https://www.itf-oecd.org/>
- [11] <https://swov.nl/en/fact-sheet/light-electric-vehicles-levs>
- [12] <https://www.alphabet.com/en-ww/micromobility-and-last-mile-trend>
- [13] <https://www.sae.org/shared-mobility/>
- [14] <https://medium.com/uber-under-the-hood/sharing-the-curb-b5fde02b97dd>
- [15] <https://www.toronto.ca/legdocs/mmis/2017/pw/bgrd/backgroundfile-109540.pdf>
- [16] <https://www.iaa-transportation.com/en/visitors/trends-and-topics/Micromobility--cargo-bikes-for-the-last-mile>
- [17] <https://hellotracks.com/blog/Five-Issues-Facing-The-Micro-Mobility-Industry/>

# The role of crowdshipping in sustainable city logistics

Jelena Milutinović, Stevan Veličković, Biljana Grgurović, Slavica Radosavljević

<sup>1</sup> Department School of Information and Communication Technologies, Academy of Technical and Art Applied Studies, Z. Celara 16, Belgrade11000, Serbia

## Abstract

In recent years, city logistics has gained more and more importance. Cities are faced with numerous challenges, such as the increase in the number of inhabitants, the increase in exhaust gas emissions, the increase in noise in urban areas, traffic congestion, etc. In terms of logistics, there has been an increase in delivery vehicles in traffic, a lack of parking spaces, infrastructure problems such as traffic bottlenecks, locating and building distribution centers, etc. The growth of e-commerce drastically affects the number of delivery vehicles and the effects they bring. A potential solution, based on the principles of sustainable development, which would have an impact on the city's economy and environment in the future, is crowdshipping. This solution represents the integration of passenger and freight traffic. Using the strategy of the sharing economy, crowdshipping is based on an already existing transport network in which passengers, in addition to traveling for their own needs, get an additional role as needed, which is most often reflected in the form of transport, i.e. the delivery of cargo/small goods. The advantages of this model are great both for ordinary citizens and for companies whose shipments/cargo are transported every day, as well as for courier operators.

**Keywords:** City logistics, sustainability, crowd shipping, shared resources.

## 1 Introduction

The production cycle in postal traffic takes place through four interdependent technological phases that consist of characteristic work operations, namely: reception, processing, transportation, and delivery. According to [1] the costs of different technological phases when handling letters and packages differ. In both cases, delivery costs have the largest share, with the fact that they make up 50% when transferring letters, while, on the other hand, transport costs are significantly higher when transferring packages.

Last mile delivery, also known as final mile delivery or final mile logistics refers to the transportation of goods from the warehouse or distribution center to the final destination - the end user. Last mile logistics is affected by numerous variables - the customer's location in relation to the warehouse or distribution center, the number of deliveries along the carrier's route, traffic in

transit, and user availability. The service provider needs to coordinate delivery deadlines, but also suffers the consequences of discrepancies in order tracking or routing errors that affect process inefficiency and lack of transparency. Customer experience - satisfaction, lack of satisfaction or dissatisfaction with the service provided, can easily build or damage the reputation of the seller, but also of courier companies. The focus is on last mile logistics as this is in many cases a key differentiator for businesses. Because consumers can easily switch where they want to order from, e-commerce businesses and their supply chain partners must provide exceptional service to gain market share and build brand loyalty. It's about customer convenience. And customer convenience can be driven by many dimensions, such as different delivery speeds and locations, customer-defined delivery times, return options and packaging. Last mile logistics, as part of the last technological phase in the transmission of shipments, is undergoing certain transformational

---

Corresponding author: Jelena Milutinović [jelena.milutinovic@ict.edu.rs](mailto:jelena.milutinovic@ict.edu.rs)

© 2023 The Author(s). This work is licensed under a Creative Commons Attribution 4.0 International License.

processes that will shape the future of the industry and define new user requirements.

According to various sources [2]–[6], important trends within the concept of the last mile are:

- sustainability - companies in every business segment give priority to sustainable solutions and implement more environmentally friendly solutions,
- the share of bulky, bulky shipments in the total number of shipments (furniture, household appliances...) is increasing,
- delivery by autonomous vehicles and trucks, drone and robotic delivery,
- modernization and development of delivery management platforms in terms of transparency and traceability,
- quick fulfillment of orders and formation of urban warehouses in order to get closer to the end user,
- delivery times change, as does the frequency,
- analysis of large postal data with the aim of increasing efficiency and reducing costs,
- the trend of reducing the Outsourcing concept and increasing the share of Insourcing in last mile logistics
- Hybrid Fleet Management Systems – scaling the size of the fleet in accordance with changes in demand (greater flexibility and affordability than the traditional model)
- drivers become traders as well
- gig economy and crowdsourcing labor market is characterized by the prevalence of short-term contracts or freelance jobs as opposed to permanent jobs.

These changes imply not only extreme speed, such as Amazon's 90-minute delivery, but also more customized services with added value, such as defining a specific time moment/interval in which the user is available and adapting to his habits and desires.

So we have a user that will drive shipping, upstream supply chain, and even manufacturing (prosumer). Each shipment chooses its own path through the supply chain and through various delivery options to best meet the needs of the customer.

With the rise of e-commerce [7], consumer preferences for last-mile delivery have become increasingly important.

Crowdshipping is an emerging trend that allows businesses to partner with regional residents to make last mile deliveries. Crowdshipping can be a solution to high shipping costs because it utilizes the unused capacity of private and public vehicles that are already on the transportation network.

## **2 Crowdshipping as part of the sharing economy**

The sharing economy represents a new paradigm that changes the existing consumer society into a more transparent, inclusive and responsible system. The essence of this model is a system of access instead of ownership of resources and is present in numerous segments of the economy and society (transportation, services, education, entrepreneurship, real estate, trade, finance, information technology).

The concept of the sharing economy based on access to goods/services versus ownership can be applied as a new business model of both postal operators through various forms of infrastructure sharing, but also by organizing partnerships in the area of shared delivery - crowdshipping delivery. [8].

Like on-demand shared transportation services, such as ride-hailing or car-sharing, crowd-shipping can introduce innovation in the traditional parcel and shipping industry. The platforms offer a more flexible service at a lower cost than traditional shipping services where are the main advantages: low delivery cost, flexibility, and eco-friendly service, but there are also disadvantages: trust issues, privacy concerns, and service quality.

Crowdshipping is a subset of the larger “crowdsourcing” movement. Essentially, crowdsourcing involves the use of technology by a large group of people with a specific goal. Retailers by partnering with a crowdshipper, can turn their vast networks of physical stores into distribution hubs for online purchases.

### **3 Application of the concept crowdshipping**

By searching the literature for the term crowdshipping, one can find several related terms that describe this phenomenon - "crowd delivery," "crowd logistics," "crowd-shipping," "crowd-sourced delivery," "crowd-sourced logistic," and "crowd-sourced shipping."

The basic idea of the concept is to hire a large number of people who will become deliverymen on a voluntary basis, and who are connected through digital platforms where there is an immediate supply and demand relationship between the participants. Deliveries do not necessarily have to be professionals, but people willing to, for a certain compensation, and moving online for their own needs, become temporary deliverers of shipments (goods). Also, there are models where people make supplementary movements in order to earn additional income because they have an excess of the necessary resources - time, will or space to deliver shipments or, sometimes, also for voluntary purposes [9]. Courier activation can also be done through bidding – the request becomes visible on the platform system and all registered couriers within a specified geographic range can begin communicating with the customer and bidding. The bidding is related to pick-up arrangements such as flexibility or timing, and does not include shipment pricing which is determined by the platform using a size and distance-based formula [10].

That this concept is close and acceptable to users is also evidenced by the results of a survey [11] conducted in the USA for potential users and employees in crowdshipping. About 80% of respondents in their dataset were willing to work as CS driver-partners. This statistic could have a significant impact on logistics carriers and on society as a whole.

Crowd-shipping system is complex, but also integrated, dynamic and sustainable. This concept promises social, economic, and environmental benefits, while at the same time, it raises questions related to concerns about trust, safety and security. Crowdshipping affects the transport system through possible changes in the share of different types of traffic in the total movement, from where the potential social impact - for health or the environment - can be determined. In this way, the unused logistical capacities of road users, but also public transport users and cyclists

are used. Crowdshipping has the potential to give consumers access to a wider range of products, as well as a more flexible, personalized service that is faster and more affordable than traditional. This specific labor market includes local travelers or long-distance travelers who, by performing this service, can compensate for travel costs, but also a large number of employees who have this part-time job, so a careful examination of the employee structure is necessary in order to be able to plan resources in advance. Also, there are indications that crowdshipping may promote wider community cohesion by fostering social ties [12].

Study [13] is the first analysis of crowdshipping users' motivations, it investigates the differences between crowdshipping users and non-users. The study found that crowdshipping is most prevalent among young people, men and permanent employees, in urban regions and at medium distances. Also, among crowdshipping users there is a significant number of those who have a developed sense of community and care for the environment. Users who express concerns and reservations about accessibility and trust are less likely to be crowdshipping users.

The analyzes presented in the study [14] are based on real market data across the United States and prioritize socio-demographic and built-environment characteristics. Given the socioeconomic characteristics of the population, the supply of casual crowdshipping drivers is unevenly distributed across geographies, with higher percentages of African-Americans, lower-wage workers, and families with two or more vehicles, while decreasing in geographies with higher population density and employment. However, it accumulates in geographic areas with greater accessibility to destinations and regional diversity of jobs. The current research, however, highlights that the availability of crowd-resources is a function of not only shipping characteristics, but also the socioeconomic and built environment characteristics of both the trip origin and the trip destination.

The crowdshipping concept is expected to create significant opportunities for sustainable urban freight by harnessing the untapped resources of individuals. On the other hand, the transfer of logistics jobs to individuals is seen as a major disruption in the organization of existing businesses. logistics models, so it is important to explore the disruptive impact and feasibility of such business models. Studies, such as [15], for

the sake of uniformity, assume that all shipments are identical and can be carried by all deliverers, regardless of their type of transport. In practice, delivery people may travel by bicycle or public transport, which could create limitations for the delivery of large and heavy parcels. Therefore, it is recommended that future research include both characteristics of shipments - weight and volume, as well as different transport models.

A comprehensive study [16] identified contradictory findings - increasing profits with long-distance delivery, while at the same time, short-distance delivery in densely populated areas may be more profitable. Implementing the service along with passenger transportation, consolidating multiple deliveries per route, and transshipment between couriers are among the potential strategies to effectively increase delivery distances and expand the service beyond just short deliveries within congested urban areas.

„Urban India – Z“ - crowdshipping application may be used for both B2C and C2C services. The empirical results [16] show that social interaction and trust are strongly and positively correlated with Generation Z participants in crowdshipping services, while monetary reward on trust has significant negative correlation. The interaction at the urban centers shows that the people are eager to work but are not informed and technology-wise poorly equipped for the job [17].

Different aspects of activity patterns and travel behavior will be impacted by crowdshipping. As a result of this system, requesters will have opportunities to enroll in new activities as some of the constraints will be removed from their daily schedule (e.g., by transferring their activities, requesters will no longer need to drive to a supermarket for grocery shopping and may spend more time with family). Similarly, carriers' participation in the crowdshipping platform can modify their activity itinerary, mode choice, trip companionship, and even the quality of their life [18].

With the application of smart logistics such as Artificial intelligence, route selection, driver recommendations, and information delivery for both drivers and senders, will be generated automatically and take a relatively short time. That's why crowd shipping needs to be integrated with smart logistics. However, there are still many things that need to be considered in the implementation of crowd shipping: shipping

insurance, item size, driver incentives, misuse of personal information, and cultural issues [19].

#### 4 Crowdshipping concept models

Within the application of this relatively new concept, there are various models. In the next part of the work, some of them will be presented, which could serve as an idea for implementation in countries where the concept has not been applied.

A microhub is a local package transshipment facility similar to the automated parcel station (APS). APS is an automated storage that allows customers to drop off and pick up packages. Package collection from APS is made possible typically by entering a mobile phone number and the access code. For ease of access, APS' are typically located at shopping centers, transit stations, gas stations, etc. As part of the Civitas Citylab project, in Amsterdam in 2018. tested a system of city center microhubs [20] in combination with freight bikes, which has led to a reduction in delivery van stops and other negative effects. Seven microhubs, carefully selected from existing PostNL stations in the City of Amsterdam are served by 50-60 freight bikes, accounting for a reduction of around 2000 van stops. By employing occasional couriers as crowdshippers for pickup and delivery services between end customers and microhubs, It could also consolidate package pickup and dropoff trips. By promoting active modes of first and last mile delivery (e.g., by bicycle or by walking), this new urban delivery paradigm of microhubs with crowdshipping would further reduce delivery costs, peak hour congestion in urban areas and emissions. Performance was evaluated by comparing with the current state-of-the practice hub-and-spoke paradigm (e.g., FedEx, UPS, USPS), in which all packages must be collected and shipped to a sorting center (hub) to be sorted before being shipped out to their respective final receivers. Participants in the transfer of shipments can use different types of traffic, and each type of traffic and the means of transport associated with it provide different carrying capacities. Also, a relay system can be organized between participants, which achieves greater flexibility in the service.

Under the concept of resource sharing, some European cities as well as Seattle in the US are encouraging shared lockers as part of their urban



sustainability policies. There are also initiatives to open the possibility of using parcel machines of postal operators for third parties (USPS - GoPost, bpost - Cubee) even up to the level of the national network. Depending on the characteristics of the shipment, the cabinet may include a temperature-controlled section optimized for food or medicine. Finally, the shared parcel locker could complement the microhub model: same-day deliveries could be done from microhubs to parcel lockers (and parcels collected from lockers transported to microhubs for delivery). In Berlin, Amsterdam, and Paris, the national posts are involved in the test of a Coordination and Optimization Technologies (COTs) - powered microhub model. This model [21] involves trucking parcels to small depots — microhubs — from which hyper-local urban delivery (within a radius of about one mile) is done faster and cleaner by carriers on foot or by small electric vehicles such as cargo bikes. While logistics operators currently use their own delivery workforces in these early experiments, they could use a mix of their own and crowdsourced deliverers in the future. The main benefit of COTs which combine algorithms, data analytics, Internet of Things, machine learning, and platform technologies is that technology complements the fixed postal network with additional and scalable infrastructure and resources, making it relatively easy and cost-efficient to manage and coordinate.

The paper [22] provides the operational flexibility of mobile depots, and the relative cost efficiency of crowd-shipping for package delivery in urban areas. The two-tier delivery model optimally selects mobile depot locations in advance of full information about the availability of crowd-shippers, and then assigns to available crowd-shippers the final leg of the shipment to the customer. Scenarios are simulated for a City of Toronto case study, in which demand is a function of population density and crowd-shipper availability is a function of observed commuting patterns.

According to the findings of a study [23] conducted in London, it was determined that delivery vehicles in the inner city spend about 60% of the total time on the route parked on the curb. The authors introduce the term 'portering' as a new concept where delivery people meet with porters and hand over part of the consignment to them, usually in light mobile carts, while they continue their route to visit remote locations or

transport heavier consignments by vehicle, which can achieve savings of 89% on some routes and about 69% in total time. Another possible scenario is that the delivery person leaves the part of the shipments in predefined acceptance points from where the carriers can pick them up. This concept would imply a larger amount of shipments than in the first case because the facility covers a larger area.

The main idea of paper [24] is to use in-store customers to deliver an online order on their way home from the store. They are spare time and spare vehicle capacity. Authors have focused on employing in-store customers to deliver online orders. The in-store availability time reflects the time that the customers are doing this shopping, after they go home or deliver one or more online orders on the way home. One of the main limitations of the approach is that it assumes knowledge about the next destination of in-store customers, based on which their routes are constructed. In practice, some in-store customers may be reluctant to reveal their destinations.

As part of the pilot research carried out in the study [25], the local population in a city in Finland delivered and picked up read books (PiggyBaggy) within the concept of crowdshipping in cooperation with the public library. In addition to the ecological and economic contributions and the analysis of the possible wider application of the concept to the delivery of food for elderly users in this way, it has a significant role in creating social cohesion and social value. Also, libraries could become a nucleus for developing and testing new ways of collaborative consumption, for instance, extending their lending portfolio from books and music titles to other consumer goods like exercise devices, tools, or other equipment required rarely.

At a time when the traditional role of the post office is changing due to the development of digital alternatives, social media offer a new way of connecting with customers, the development of new products that unite the physical and digital worlds and reveal new opportunities for the positioning of postal services - they are not only present, but relevant and vital in the new communication environment [26]. Social commerce tends to be viewed as a transaction that's facilitated by social networks. Postal tracking technology also could be viewed as social engagement - it's talking to customers and letting them know what's going on.

Crowd workers typically prefer to remain anonymous; however, being anonymous may easily cause one to be or become unreliable. By using friends and acquaintances chosen by individuals with a certain level of friendship from within their social networks, one alleviates the privacy concerns at least in part; and a customer will always be able to opt out of crowdsourced delivery. This way of functioning leads to the development of social capital (social benefits resulting from inclusion in social networks and organizations such as clubs, religious communities, non-profit associations, and unions, as well as various forms of cooperation and connection with neighbors and family). The concept involves users sharing their location on social networks to help each other by delivering ordered goods that are on a planned route. A study [27] conducted in the city of Alexandria, Virginia examines the potential of using contacts on social networks, but also points out possible problems: what is the level of friendship/acquaintance for users to feel comfortable in this process, and are people ready and under what conditions should they minimally deviate from their route in order to pick up the shipment. In this way, the problem of "not-at-home syndrome" and the "ping-pong" effect (when agreed-upon delivery times are not met by customers) which, in real conditions, require expensive subsequent delivery, would be alleviated. The paper considered the delivery of one friend once, but the authors believe that in the future there is also the possibility that more people can deliver to one person or that there is a relay system.

#### **4.1 Crowdshipping and public transport**

In addition to their own means of transport, delivery people in crowdshipping can also use public transport, and several such studies are presented below.

In [28], the idea of applying the crowdshipping concept in combination with the use of public urban transport, where shipments are delivered through a regular flow of passengers while reducing the number of delivery vehicles entering central city districts, is presented. The test took place in the Danish capital and northern Jutland over a period of two months, in which 28 automated parcel lockers (APL) were installed at public transport stations/stops. The applicability of the concept is illustrated by examining the attitude of the participants in the pilot project - the

experience with the service was positively evaluated with a high degree of acceptance. One of the important criteria is the location of APL. Participants were more willing to take a package on the way back than on the way out. This could potentially be a challenge, as the solution would optimally utilize commuters from the periphery on their way to work or school in the central parts of the city. Also, outbound trips may be easier to fit into existing routines because inbound trips have time constraints associated with work hours or layovers, so the extra time to find APLs or access the application produces additional stress or dissatisfaction that can lead to giving up on execution services. An important precondition for the implementation of this service is the good functioning of the Public Transport System - reliability and predictability.

Exploring motives for the use crowdshipping authors in [29] indicate that a crowdshipping solution might increase chances of success by catering to altruistically and socially oriented values, by framing participation environmentally towards users rather than focusing on economic incentives in its design and communication. This principle includes the experience of positive emotions caused by living in accordance with one's own and others' ideals - "doing good" as well as being part of a social group that shares these values.

The research [30] refers to the city of Rome and considers an environmental-friendly crowdshipping based on the use of the mass transit network of the city, where customers/crowdshippers pick-up/drop-off goods in automated parcel lockers located either inside the transit stations or in their surroundings. The potential of APLs is connected with the metro network, thus proposing a more environmentally friendly crowdshipping with respect to a fully based rubber-tired crowdshipping.

The implementation case study refers to the city of Rome, Italy, and addresses its metro lines, thus understanding and quantifying the effects of this freight transport strategy for e-commerce in an urban context [31]. The highest potential impact of this innovative service is linked to e-commerce and food/groceries-related deliveries. The idea is to involve people using public transport which, on average, imposes lower environmental and congestion costs on society. The authors investigated what percentage of commuters would be willing to work as a

crowdshippers with different defined services. The results, although preliminary, are encouraging - there is high confidence in the success of the service (about 48% of the sample) and the estimated number of potential crowdshippers for the case of Rome is actually higher than the potential demand.

## 5 New business models

Q-commerce ('quick commerce') - sometimes used interchangeably with 'on-demand delivery' and 'e-grocery' - is e-commerce in a new, faster form. Q-commerce, refers to a new trend in e-commerce that emphasizes fast, on-demand delivery of goods and services. Q-commerce is similar to traditional e-commerce in that it allows consumers to order products online, but it differs in terms of speed and convenience. With q-commerce, customers can typically receive their orders within hours or even minutes, rather than waiting days for traditional delivery services. The q-commerce is nothing new. It has been used in the takeaway food industry for many years. Q-commerce is a must for brands that target professionals and older people. Speed is guaranteed by the existence of hyper-local micro-fulfilment centers ('dark stores') dotted around densely populated stretches of cities and positioned in close proximity to those making orders. These organizations monitor customer behavior patterns and adjust inventory to guarantee the availability of the requested products. In addition, an additional benefit is the ease of use and 24/7 availability.

Certain operators, e.g. Amazon, develop trust-based services such as In-home delivery, In-car delivery, In-garage and In-fridge delivery. The service is connected to a lock (Key by Amazon) and a security system and allows the delivery person, using a one-time code, to enter the user's house and leave the package while he can later view the complete video of the delivery or track it in real-time. Walmart has gone one step further – it wants to reach consumers' kitchens and refrigerators. Similar to Amazon's home access model, it equips workers with body cameras to ease consumer concerns about strangers entering their homes. Additionally, Walmart is pledging to ensure employees have been on the job for at least 12 months before being allowed into customers' homes and will include brief biographies of each worker in its delivery app to personalize the experience and start building trusting customers

of this service. In the future, work is expected on regulations that could regulate complicated relationships between users and service providers, because providing privacy in this way is very susceptible to abuse, while on the part of the service provider, it reduces delivery failure to zero [32].

Universal Postal Union (UPU) defines postal social services [33] as services that are explicitly designed to provide a direct benefit to society, that are provided regularly, reliably and are widely accessible. Some social services generate direct income for the post office, others achieve goals defined through a socially responsible business strategy, and improve visibility and brand recognition, while certain postal social services are designed to support governments in implementing their social obligations and policies. UPU has defined six important areas within which there are around 40 services that different postal administrations already offer: health and well-being, education, social cohesion, participation and inclusion, access to government services, waste, recycling, energy and utilities, and data and technology. For countries that are just entering the process of providing social services, it is important to look at the experiences of other operators because future demand may vary depending on the geographic region or the end user.

## 6 Conclusion

The paper presents the concept of crowdshipping as part of the sharing economy. Through a review of scientific and professional literature, various forms that have already been implemented in urban areas are shown, as well as research into the basic advantages and challenges related to the motives and trust of all interested parties, the effects on society, and the environment, and the efficiency and effectiveness of these models. This sustainable concept combines environmental, economic and social aspects. The postal sector needs to promote a culture of adapting services to the changing needs of society, while embracing new technology, and implementing innovations to remain relevant to the public and focused on the future.

Future research in this area could aim to apply this concept in suburban and rural areas with a special emphasis on the realization of a human and inclusive service that provides access to

social resources, institutions, and processes and focuses on vulnerable individuals.

## References

- [1] P. Team John Dodgson José Maria Rodriguez Jan Peter van der Veer Stephen Gibson Juan Hernandez Barbara Veronese, "ECONOMICS OF POSTAL SERVICES: FINAL REPORT A Report to the European Commission DG-MARKT Prepared by NERA," 2015. [Online]. Available: <http://www.nera.com>
- [2] "How can you prepare for the latest trends affecting final-mile logistics?" <https://www.parcelandpostaltechnologyinternational.com/opinion/trends-in-final-mile-logistics.html> (accessed Apr. 11, 2023).
- [3] "Top 9 Last Mile Delivery Trends to Watch." <https://dclcorp.com/blog/shipping/last-mile-delivery-trends/> (accessed Apr. 10, 2023).
- [4] "9 Last Mile Delivery Trends You Won't Want to Miss." <https://legacyscs.com/last-mile-delivery/> (accessed Apr. 09, 2023).
- [5] "What are the Top 7 Trends in Last Mile Logistics?" <https://supplychaingamechanger.com/what-are-the-trends-in-last-mile-logistics/> (accessed Apr. 10, 2023).
- [6] "5 last mile delivery trends that will impact 2023." <https://www.bringoz.com/5-last-mile-delivery-trends-that-will-impact-2023/> (accessed Apr. 15, 2023).
- [7] "EUROPEAN E-COMMERCE REPORT 2022." [Online]. Available: [www.ecommerce-europe.eu](http://www.ecommerce-europe.eu)
- [8] S. Dumnić, M. Ninović, and Đ. Dupljanin, "LOGISTIČKA SARADNJA U EKONOMIJI DELJENJA," University of Belgrade - Faculty of Transport and Traffic Engineering, Nov. 2021. doi: 10.37528/fte/9788673954455/postel.2021.012.
- [9] N. Bojković, M. Petrović, and T. Živojinović, "CROWDSOURCED DOSTAVA: MOGUĆNOSTI I IZAZOVI," University of Belgrade - Faculty of Transport and Traffic Engineering, Nov. 2022. doi: 10.37528/fte/9788673954165/postel.2022.006.
- [10] A. Ermagun and A. Stathopoulos, "Crowd-shipping delivery performance from bidding to delivering," *Research in Transportation Business and Management*, vol. 41, Dec. 2021, doi: 10.1016/j.rtbm.2020.100614.
- [11] T. V. Le and S. V. Ukkusuri, "Crowd-shipping services for last mile delivery: Analysis from American survey data," *Transp Res Interdiscip Perspect*, vol. 1, Jun. 2019, doi: 10.1016/j.trip.2019.100008.
- [12] T. V. Le, A. Stathopoulos, T. Van Woensel, and S. V. Ukkusuri, "Supply, demand, operations, and management of crowd-shipping services: A review and empirical evidence," *Transportation Research Part C: Emerging Technologies*, vol. 103. Elsevier Ltd, pp. 83–103, Jun. 01, 2019. doi: 10.1016/j.trc.2019.03.023.
- [13] A. Punel, A. Ermagun, and A. Stathopoulos, "Studying determinants of crowd-shipping use," *Travel Behav Soc*, vol. 12, pp. 30–40, Jul. 2018, doi: 10.1016/j.tbs.2018.03.005.
- [14] A. Ermagun and A. Stathopoulos, "To Bid or Not To Bid: An Empirical Study Of The Supply Determinants of Crowd-Shipping," 2018. [Online]. Available: <http://www.elsevier.com/open-access/userlicense/1.0/>
- [15] H. Ghaderi, P. W. Tsai, L. Zhang, and A. Moayedikia, "An integrated crowdshipping framework for green last mile delivery," *Sustain Cities Soc*, vol. 78, Mar. 2022, doi: 10.1016/j.scs.2021.103552.
- [16] E. Pourrahmani and M. Jaller, "Crowdshipping in last mile deliveries: Operational challenges and research opportunities," *Socio-Economic Planning Sciences*, vol. 78. Elsevier Ltd, Dec. 01, 2021. doi: 10.1016/j.seps.2021.101063.
- [17] C. K. Upadhyay, V. Tiwari, and V. Tiwari, "Generation 'Z' willingness to participate in crowdshipping services to achieve sustainable last-mile delivery in emerging

- market,” *International Journal of Emerging Markets*, 2022, doi: 10.1108/IJOEM-09-2021-1345.
- [18] M. Allahviranloo and A. Baghestani, “A dynamic crowdshipping model and daily travel behavior,” *Transp Res E Logist Transp Rev*, vol. 128, pp. 175–190, Aug. 2019, doi: 10.1016/j.tre.2019.06.002.
- [19] C. H. Setiawan and A. Santoso, “Integration of Smart Logistic and Crowd shipping for Sustainable City Logistic.”
- [20] S. Ballare and J. Lin, “Investigating the use of microhubs and crowdshipping for last mile delivery,” in *Transportation Research Procedia*, Elsevier B.V., 2020, pp. 277–284. doi: 10.1016/j.trpro.2020.03.191.
- [21] “Coordination and Optimization Technologies and Postal Applications,” 2018.
- [22] K. Mousavi, M. Bodur, and M. J. Roorda, “Stochastic Last-mile Delivery with Crowd-shipping and Mobile Depots.”
- [23] J. Allen *et al.*, “Text (5314), References (997).”
- [24] I. Dayarian and M. Savelsbergh, “Crowdshipping and Same-day Delivery: Employing In-store Customers to Deliver Online Orders.”
- [25] H. Paloheimo, M. Lettenmeier, and H. Waris, “Transport reduction by crowdsourced deliveries – a library case in Finland,” *J Clean Prod*, vol. 132, pp. 240–251, Sep. 2016, doi: 10.1016/j.jclepro.2015.04.103.
- [26] J. Milutinović and B. Stanivuković, “NASTUP VELIKIH POŠTANSKIH OPERATORA U DIGITALNOM OKRUŽENJU,” University of Belgrade - Faculty of Transport and Traffic Engineering, Nov. 2021. doi: 10.37528/fte/9788673954455/postel.2021.015.
- [27] A. Devari, A. G. Nikolaev, and Q. He, “Crowdsourcing the last mile delivery of online orders by exploiting the social networks of retail store customers,” *Transp Res E Logist Transp Rev*, vol. 105, pp. 105–122, Sep. 2017, doi: 10.1016/j.tre.2017.06.011.
- [28] A. Fessler, P. Cash, M. Thorhauge, and S. Haustein, “A public transport based crowdshipping concept: Results of a field test in Denmark,” *Transp Policy (Oxf)*, vol. 134, pp. 106–118, Apr. 2023, doi: 10.1016/j.tranpol.2023.02.014.
- [29] A. Fessler, C. A. Klöckner, and S. Haustein, “Formation of crowdshipping habits in public transport: Leveraging anticipated positive emotions through feedback framing,” *Transp Res Part F Traffic Psychol Behav*, vol. 94, pp. 212–226, Apr. 2023, doi: 10.1016/j.trf.2023.02.012.
- [30] V. Gatta, E. Marcucci, M. Nigro, S. M. Patella, and S. Serafini, “Public transport-based crowdshipping for sustainable city logistics: Assessing economic and environmental impacts,” *Sustainability (Switzerland)*, vol. 11, no. 1, Jan. 2019, doi: 10.3390/su11010145.
- [31] S. Serafini, M. Nigro, V. Gatta, and E. Marcucci, “Sustainable crowdshipping using public transport: A case study evaluation in Rome,” in *Transportation Research Procedia*, Elsevier B.V., 2018, pp. 101–110. doi: 10.1016/j.trpro.2018.09.012.
- [32] J. Milutinović and Đ. Popović, “INOVATIVNI MODEL POSLOVANJA U FUNKCIJI ODRŽIVOG RAZVOJA U POŠTANSKOM SEKTORU,” University of Belgrade - Faculty of Transport and Traffic Engineering, Nov. 2020. doi: 10.37528/fte/9788673954318/postel.2020.015.
- [33] *UPU Guide to POSTAL SOCIAL SERVICES*. 2021.

# Sustainable and smart urban mobility strategies of the EU countries and the Western Balkans

Valentina Ivanović<sup>1</sup>, Arnela Mujić<sup>2</sup>, Edin Gadžo<sup>3</sup>, Osman Lindov<sup>4</sup>

<sup>1</sup>Republička uprava za inspekcijske poslove, Trg Republike Srpske 8, Banja Luka, Bosnia and Herzegovina

<sup>2</sup>Rock n Log doo, Masarikova 17, Zenica, Bosnia and Herzegovina

<sup>3</sup>JP Autoceste FBiH d.o.o. Mostar, Hamdije Kreševljakovića 19, Sarajevo, Bosna i Hercegovina

<sup>4</sup>Faculty of Traffic and Communications, University of Sarajevo, Zmaja od Bosne 8, Sarajevo, Bosnia and Herzegovina

## Abstract

Speeding up the transition to clean, sustainable and smart mobility is key to improving the citizen's life quality and contributes to the EU climate goals set by European Green Deal, which represents EU strategy for achieving the climate goal for 2050, actually the reduction of emissions associated with transport for 90%. The fact that the countries of the Western Balkans are one of the most affected by climate changes in Europe, mostly due to transport sector influence, is the basis of the sustainable and smart mobility Strategy of the Western Balkans adopted in 2021 within the Transport Community Secretariat. This Strategy sets goals and a coordinated approach to create sustainable and smart urban mobility of the Western Balkans on the model of the EU sustainable and smart mobility Strategy, adapting the EU goals and actions to the actual situation and the possibilities of transport sector decarbonization and digitization in these countries. This Strategy defines leading steps to make transport in the Western Balkans cleaner, safer, smarter, greener, more resilient, more competitive and sustainable. The paper will review the activities of Bosnia and Herzegovina in terms of achieving the goals set by the EU and the Western Balkans sustainable and smart mobility Strategy.

**Keywords:** *Strategy, Sustainable and smart mobility, Transport, European Green Deal*

## 1 Introduction

The basis of sustainable mobility is a sustainable and smart transport system and infrastructure, which are of vital importance for the full exploitation of the economic strengths of all countries, for supporting the single market, recovery from the current crisis and stimulating future growth and also for enabling economic, social and territorial cohesion, while preserving environment and health.

It is known that traffic significantly contributes to air and noise pollution and has harmful effects on the environment, so there is a need to accelerate the transition to sustainable and smart mobility and deliver zero pollution, as well as an environment without toxic substances.

Regarding to this, the concept of sustainable and smart mobility requires precisely sustainable, smart and flexible traffic and transport systems that should satisfy the basic need of citizens to integrate into society and the labor market, to connect and open the market, but also to bring EU countries and Western Balkans closer together and making them more accessible for everyone. On the other hand, transport is the only economic sector in which greenhouse gas emissions have started to rise again since 2013 despite mitigation efforts, which is the main reason why the European Green Deal has set a key goal of reducing greenhouse gas emissions by 2050 up to 90%.

---

Corresponding author: *Valentina Ivanović (Valentina.Ivanovic@fsk.unsa.ba)*

© 2023 The Author(s). This work is licensed under a Creative Commons Attribution 4.0 International License.

The aim of this paper is to present that Bosnia and Herzegovina has sufficiently good preconditions for creating its own urban mobility strategy, guided by the practice of making and the goals of EU and Western Balkan strategies.

## 2 EU mobility environmental impact

The climate changes that affect Europe, especially the Western Balkans, are mostly the result of mobility, i.e. traffic, so it must be made cleaner, safer, smarter, greener, more resistant, competitive and sustainable through carefully selected and defined steps, achievable actions and measures. Consequently, the EU is constantly focusing its activities on the creation of a sustainable, ecologically cleaner and smart transport system that can meet all the needs of citizens.

From 1980 to 2020, more than 138,000 people lost their lives due to extreme weather conditions and phenomena related to climate changes. In the last 5 years, the average temperature is for 2.2°C higher than at the end of the 19th century. Financial losses as a result of climate change in the last 40 years have cost Europe more than 487,000 billion €, and every year more than 5 billion € cost Europe floods and more than 2 billion € from fires [1]. These devastating data indicate that all efforts should be focused on solving the climate and environmental crisis, which is the defining challenge of our time and an opportunity to restart the economy in a sustainable way. This requires urgent and sustained action by all society actors to preserve the health, prosperity and well-being of people in Europe and further.

Although mobility brings many advantages for its users, on the other hand it also brings costs for our society. This includes greenhouse gas emissions, air, noise and water pollution, as well as traffic accidents, traffic jams and loss of biodiversity, that affect the health and well-being of humanity. Previous efforts and policy measures have not yet sufficiently addressed these costs. The transport sector, although the basis of the economic, social and economic growth and development of every country, is at the same time a source of great pressure on the environment, with the participation of about ¼ in the creation of all greenhouse gases. In this sense, the influence of road traffic on the generation of greenhouse gases is particularly pronounced, with a

participation of about 71% in the generation of all greenhouse gases from the transport sector [1].

The above-mentioned indicates a need of quick and ambitious reaction of all actors in society, as well as a change in the awareness and habits of citizens in order to face the current challenges regarding the impact on the environment. Regarding to this, the EU has committed itself to achieve climate neutrality by 2050 and fulfill its obligations under the international Paris Agreement. Achieving that goal requires a financially efficient, right and socially balanced transformation of society and the economy [2].

### 2.1 Sustainable and smart urban mobility concept

"Sustainable mobility is mobility that meets society's needs for free movement, access, communication, establishing connections and relationships, without sacrificing other human and environmental needs, today and in the future" [3].

Sustainable mobility management is a concept that refers to the creation of a long-term sustainable traffic system that enables a high degree of mobility for the largest possible number of citizens of a certain area. It is used in order to solve the problems that today's traffic systems generate, such as loss of time, human lives, harmful impact on the environment, harmful impact on human health and large space occupation.

Sustainable mobility implies actively advocating for a change in the way of traffic, transport and transportation, habits and behavior of passengers in order to reduce the negative consequences of traffic on society, the environment and the economy, such as:

- air pollution resulting from climate change,
- noise,
- traffic jams,
- traffic accidents,
- degradation of urban areas (reduction of space for pedestrians due to the number of vehicles increase),
- land exploitation (increasing construction of road infrastructure).

Changes in the personal attitudes and actions of citizens are necessary, in order for the concept of urban mobility to have a purpose and to reach the set goals of sustainable development, i.e.

people should reconsider their values and change their behavior to adopt a sustainable life.

### **3 EU sustainable and smart mobility policy**

At the end of 2019, the European Commission announced a new growth strategy, called the European Green Deal, which should enable sustainable and inclusive growth, the implementation of the United Nations program until 2030 and goals of sustainable development, and the transition towards a just and prosperous society with a modern, resource-efficient and competitive economy in which case there will be no greenhouse gas emissions in 2050. Therefore, the European Green Deal represents an EU strategy that aims to ensure the EU's green transition, with the ultimate goal being to achieve climate neutrality by 2050, and contains a package of initiatives in the area of the following policies for its implementation:

- Climate policy;
- Energy policy;
- Industrial policy and circular economy;
- Construction;
- Environmental protection and biodiversity;
- Agriculture and tourism;
- Mobility;
- Social policy;
- Research, development and innovation.

The rules adopted by the European Green Plan, which refer to the transport sector, are:

- Stricter criteria for CO<sub>2</sub> emissions from cars and vans;
- New infrastructure for alternative fuels;
- ReFuelEU: more sustainable aviation fuels;
- FuelEU: cleaner marine fuels.

#### **3.1 EU Sustainable and Smart Mobility Strategy**

The development of strategic, integrated traffic planning, the establishment of appropriate mobility planning organizations and realistic goals setting are key to solving the long-term challenges of urban mobility, while supporting cooperation between transport operators. Guided by this, in December 2020, the European Commission adopted and presented the Sustainable and Smart Mobility Strategy, which connects the EU Green Deal with the Digital Agenda for Europe, structured on the basis of three key goals: make the European transport system sustainable, smart and resilient. The

strategy establishes an action plan with concrete measures, based on 10 initiatives and 82 measures that will guide the work in the coming years, and through the cross-section of the goals presented below for 2030, 2035 and 2050 [2].

a) Goal for 2030:

- At least 30 million zero-emission cars will be in operation on European roads;
- 100 European cities will be climate neutral;
- High-speed rail traffic will double across Europe;
- Anticipated collective journeys for journeys of less than 500 km should be carbon neutral;
- Automated mobility will be deployed on a large scale;
- Zero-emission marine vessels will be ready for the market.

b) Goal for 2035:

- Large zero-emission aircraft will be ready for the market.

c) Goal for 2050:

- Almost all cars, vans, buses, as well as new heavy vehicles will be emission-free;
- Railway freight traffic will double;
- Fully operational, multimodal trans-European transport network (TEN-T).

The action plan within the Strategy is based on the fact that an integrated approach can best deal with the complexity of the urban transport system, management issues and connections between cities and their surrounding areas or regions, interdependence between modes of transport, limitations within the urban space and urban systems in the wider European transport system. An integrated approach is needed not only for the development of transport infrastructure and services, but also for the creation of policies linking traffic with environmental protection, a healthy environment, planned land use, housing, social aspects of accessibility and mobility, as well as industrial policy [4].

##### *3.1.1 EU Sustainable and Smart Mobility Strategy Pillars*

Starting from creating a sustainable, smart and resilient European transport system concept, the basis of the EU Sustainable and Smart Mobility Strategy consists of the following three pillars:

- Pillar 1: Sustainable mobility - irreversible transition to mobility with zero emissions;



- Pillar 2: Smart mobility - uninterrupted, safe and efficient connectivity;
- Pillar 3: Resilient mobility - a more resilient single European traffic area.

**Sustainable mobility** implies that a clear path is needed to achieve a 90% reduction in transport-related greenhouse gas emissions by 2050 to ensure that the EU becomes the first climate-neutral continent by 2050 as called for by the European Green Deal.

**Smart mobility** implies that digitization will become an indispensable driver for the modernization of the entire transport system, making it seamless and more efficient, with a constant emissions reduction, and that digitization and automation should be used to safety, efficiency, reliability and comfort increase, thus maintaining the European Union's leadership in production and transport equipment services and improving global competitiveness through efficient and resilient logistics chains.

**Resilient mobility** is based on the fact that it is very important to preserve the single market and supply chains, as well as a coordinated European approach to connectivity and transport activities, which is key to overcoming any crisis and strengthening the EU's strategic autonomy and resilience in conditions of limited movement. Initiatives within the Strategy pillars are:

1. Encouraging wider use of zero-emission vehicles, renewable and low-carbon fuels and related infrastructure;
2. Airports and ports with zero emissions;
3. More sustainable and healthier intercity and city mobility;
4. Greening of cargo transportation;
5. Carbon pricing and better incentives for users;
6. Achieving connected and automated multimodal mobility;
7. Innovations, data and artificial intelligence for smarter mobility;
8. Strengthening the single market;
9. Fair mobility for all;
10. Increasing safety and protection in traffic.

#### **4 Sustainable and Smart Mobility Strategy of the Western Balkans**

In the past, the Western Balkans were greatly affected by climate change, and as a region they are seen as one of the most affected by climate

change in Europe. The estimated increase in temperature was from 1.7°C to 4°C with an estimate that in the coming period it will be up to 5°C, depending on the reduce greenhouse gas emissions global efforts. The main source of greenhouse gases in the countries of the Western Balkans are the energy and transport sectors, which account for 2/3 of the total share of greenhouse gases. The transport sector accounted for about 12% of greenhouse gases in 1990, while its share increased to 16% by 2018. In the total share of emissions, road traffic is dominant with a share of more than 90%, which is especially pronounced in urban areas of the region, as well as areas with a large number of residents [5].

By adopting the European Green Deal, EU is determined to become a global leader and drive the transition to net zero emissions, helping and inspiring others to follow the same path. The Western Balkans joined this initiative by signing the Sofia Declaration on the Green Program for the Western Balkans. This determination emphasizes the need to define a clear program that will consider the necessary changes in various economic sectors to achieve this ambitious goal by 2050.

Recognizing the need to chart a path to climate neutrality by 2050, it was necessary for the economies of the Western Balkans to define legally binding goals with timelines and programs, while providing regulatory and financial mechanisms and capacity for implementation. This was possible to define by creating and adopting its long-term development strategy for low greenhouse gas emissions in accordance with the provisions of the European Union Climate Act, the Management Regulation and other elements of the EU climate policy. Regarding to this, it was adopted the Sustainable and Smart Mobility Strategy of the Western Balkan countries, which reflects the policies and priorities described in the Economic and Investment Plan for the Western Balkans, as well as the goals of the Green Deal.

The road map as part of this Strategy is intended as a leading document for the region in the preparation of the national strategies. The proposed timelines are indicative only, and interventions are designed to address infrastructure or software implementation, legislative changes, analytical research and studies, capacity building and training, and policy interventions.

#### **4.1 Western Balkans strategic measures adaptation to the EU measures**

The priority in the Western Balkans was the urgent adjustment of climate policy, determination of transitional climate and energy goals until 2030 in accordance with the increased ambitions of the EU and the transposition of the “Ready for 55%” package and the EU climate law. According to this, harmonization with the EU Strategy on adapting to climate change, increasing the use of natural and artificial stored carbon reserves and ensuring faster green transformation of all economic sectors with an emphasis on one with high carbon dioxide emissions is necessary.

The strategic vision of the Permanent Secretariat of the Transport Community is to help regional parties to make traffic in the Western Balkans cleaner, safer, smarter, greener, more resilient, more competitive and sustainable. This vision is the key driver of transport policy, both in the EU and in the Western Balkans. At the EU level, it represents the central part of the agreed EU Green Deal and the EU Sustainable and Smart Mobility Strategy published in December 2020, while at the regional Western Balkans level it is part of the Green Agenda for the Western Balkans confirmed by the Declaration of the Summit in Sofia and the Economic and Investment Plan of the European Commission for Western Balkans [5].

In order to harmonize and adjust the policy and goals of the Western Balkans with the policy and goals of the EU in terms of achieving climate neutrality, an Action Plan for the implementation of the Sofia Declaration on the Green Program for the Western Balkans for 2021-2030 was drawn up, which specifies that the economies of the Western Balkans should increase the rate of implementation of their current obligations, but at the same time adapt to the changes taking place in the European Union in all areas (energy, transport or climate activities) and to integrate latest targets into their policy and legal frameworks to ensure climate neutrality by 2050 [6].

The strategy of sustainable and smart mobility actually reflects the EU strategy which seeks to direct the Western Balkans towards achieving green mobility. This strategy describes how the transport system of the Western Balkans can achieve its green and digital transformation and become more resilient to future crises [5]. The initiatives on which the Sustainable and Smart

Mobility Strategy of the Western Balkan countries is based are fully adapted to the initiatives of the EU Strategy and each initiative is classified as a determinant of the pillars of the WB (Western Balkans) Strategy: sustainable, smart and resilient mobility. This document is intended as a guide for the region in the preparation of national strategies, and the proposed deadlines for achieving the goals are only indicative.

#### **5 Bosnia and Herzegovina in the urban and smart mobility strategy developing process**

Bosnia and Herzegovina, as one of the countries of the Western Balkans, has been affected by climate change, which in the last few years had left enormous and harmful consequences on the economy and society. As a developing country, Bosnia and Herzegovina can hardly respond to these problems and compensate for what has been lost, so the activities and certain resources should be directed in order to reduce these problems and impacts if it is not possible to completely eliminate or avoid them.

Given that the Sustainable and Smart Mobility Strategy of the Western Balkans represents the basis for the development of national mobility strategies, with the aim of achieving the set results by 2030 and 2050, the ministries responsible for transport are encouraged to use this document as a tool to facilitate the development and strengthening their own national strategy document and also to form strong partnerships with other relevant ministries in order to advance specific actions and progress in achieving the goals of sustainable and smart mobility [7].

Based on the fact that all Western Balkans countries (except Kosovo) have ratified the UN Framework Convention on Climate Change, the Kyoto Protocol and the Paris Agreement, and also that according to the Paris Agreement the region has decided to keep the increase in the global average temperature below two degrees, it remains for Western Balkans to find different ways of solving environmental pollution, through national strategies, policies, etc. make progress on environmental protection, i.e. creating sustainable, smart and resilient mobility. Regarding to above-mentioned, we can consider that Bosnia and Herzegovina has a good foundation for the development and creation of a

national sustainable and smart mobility strategy. Through the defined action plan of the strategy, it will be possible to undertake activities to improve the legislative framework, the development of traffic infrastructure and ITS [8].

An important association and documents in the sustainable urban development and mobility segment of Bosnia and Herzegovina are given in tables 1, 2 and 3.

**Table 1.** Energy Community EU, Southeast Europe and Observers – documents [9]

B&H Documents (Study; Strategy; Action Plan)	
✓	Energy efficiency action plan of Bosnia and Herzegovina for the period 2016 – 2018 (2015)
✓	National Emission Reduction Plan for Bosnia and Herzegovina November 2015
✓	National renewable energy action plan of Bosnia and Herzegovina (NREAP B&H) (2016)
✓	E-mobility in the Energy Community Contracting Parties Survey on the legal and regulatory framework and role of regulators, June 2021
✓	Study on 2030 overall targets for the Energy Community Energy efficiency, RES, GHG emissions reduction, June 2019
✓	Framework Energy Strategy of Bosnia and Herzegovina until 2035 (2018)
✓	National Energy and Climate Plan (NECP) (2020)

Note that the Energy Community members are Albania, Kosovo\*, North Macedonia, Georgia, Moldavia, Montenegro, Serbia, Ukraine, EU/EC. Observers are Armenia, Norway and Turkey.

**Table 2.** Transport Community Western Balkans documents [10]

B&H Documents (Study; Strategy; Action Plan)	
✓	Strategy for Sustainable and Smart Mobility in the Western Balkans
✓	2. Strategy for Sustainable and Smart Mobility in the WB-2022_Progress Report

Note that the Transport Community members are Serbia, Albania, North Macedonia, Montenegro and Kosovo\*.

**Table 3.** Bosnia and Herzegovina documents [11]

B&H Documents (Study; Strategy; Action Plan)	
Ministry of Communications and Transport of B&H	Transport Strategy B&H, 2016; Framework Transport Strategy 2020; Action Plan for Bosnia and Herzegovina, December 2022. Not approved yet, Expect approved 2023.
Ministry of Foreign Trade and Economic Relations of B&H	BH ESAP 2030+ Environmental Strategy and Action Plan -2032 (not finished yet)
Other Documents	
NEAP	National Environmental Action Plan
KEAP	Canton Environmental Action Plan
LEAP	Local Environmental Action Plan
SEAP	Sustainable Energy Action Plan
SUMP	Sustainable Urban Mobility Plan
SECAP	Sustainable Energy and Climate Action Plan
GCAP	Green City Action Plan

All the previously presented documents in these tables are good and important basis for creating the national B&H urban and smart mobility strategy. Some of them contain important guidelines, conditions and facts that can help in creating a strategy.

It is important to note that Bosnia and Herzegovina has adopted the Framework Transport Policy for 2015-2030 as a basic document for the transport sector progress and development process, adoption of development strategies, regulations, programs, plans and other acts. This document is also important for making decisions on development directions, action plans and priorities at the national level, its entities and the Brčko District of B&H, all in accordance with the Constitution of Bosnia and Herzegovina. According to the adopted Framework Transport Policy, the transport sector must contribute to sustainable and stable economic development through four general goals that should be achieved through specific actions, in accordance with the needs and uniqueness of the entities and Brčko District of Bosnia and Herzegovina [12]:

- ensure institutional efficiency,
- ensure financial sustainability,
- encouraging economic development and
- solving ecological and social impacts.

With the aim of sustainable transport system development, the B&H Framework Transport Policy set the following six goals:

- satisfy social and economic demand,
- provide the highest level of service at the lowest possible prices,
- meet information and security requirements,
- financial sustainability (to be financially sustainable and based on the main sources of funding ranging from user fees, municipal budget funds and the involvement of the private sector to meet the needs in terms of transport infrastructure maintenance, improvement and development),
- be in accordance with EU standards and regulations,
- have a minimal negative impact on the environment.

The adopted Framework Transport Strategy for 2016-2030 determines the procedures and programs to be undertaken in terms of administrative reforms, regulatory alignment, capacity building and investment programs, as well as the distribution of responsibilities, time frame and key performance indicators. This Strategy aims to develop the local economy and society while ensuring the sustainable development of the transport system, such that it meets the requirements regarding the improvement of the mobility of goods and people and physical access to markets, workplaces, education and all other social and economic needs [8].

The Framework Transport Strategy defines an action plan that sets specific goals for the minimal negative transport sector impact on the environment, namely [8]:

- harmonization of EIA (Environmental Impact Assessment) with EU standards,
- monitoring the emission of harmful gases,
- improving different types of transport usage for transporting passengers and cargo,
- alignment with EU standards on vehicle emissions and
- reduction of the average age of vehicles.

Bosnia and Herzegovina, as a country that is not a member of the Annex and Framework Convention of the United Nations on Climate Change (UNFCCC), is obliged to submit its national Climate Change Reports (NC) every four years, and biannual reports on greenhouse gas emissions every two years. UNDP B&H, in partnership with the competent ministries and

authorities in B&H, and with the financial support of the Global Environment Facility (GEF), started the implementation of the project Preparation of the Fourth National Report of Bosnia and Herzegovina according to the UNFCCC, which was supposed to be finalized at the end of 2022. The Fourth National Report (FNC) will update and improve information related to climate change, greenhouse gas inventory, climate change mitigation, climate change vulnerability and steps taken to adapt to climate change, as well as information on public awareness, education, training, system research, and technology transfer [13]. All of this can be good input data for the creation of a national sustainable and smart mobility B&H strategy.

Activities related to sustainable urban mobility have been started in Bosnia and Herzegovina since 2019, so in April the Federation of Bosnia and Herzegovina municipalities and cities Union started implementing the project "Sustainable Urban Mobility in the Municipalities of Federation of Bosnia and Herzegovina" with the support of the GIZ Open Regional Fund, Energy Efficiency (ORF EE), and the project "Sustainable urban mobility in the countries of Southeast Europe II (SUMSEEC II)". The goal of the project is the development of sustainable, energy-efficient and green transport solutions for the cities of Southeast Europe using good practices from the EU/Germany and following the EU 2030 Energy Strategy, as well as the goals of sustainable development (especially Goal 11 - Sustainable cities and communities) [14].

In July 2020, the Sustainable Urban Mobility Plan of the Canton of Sarajevo and the City of Sarajevo - SUMP was adopted in Federation of Bosnia and Herzegovina, and it was prepared Draft for the Sustainable Urban Mobility Plan of Zavidovići Municipality in the same period. At the level of RS, the Sustainable Urban Mobility Plan of the City of Bijeljina - SUMP was adopted in the same period, while the project of creating a Sustainable Urban Mobility Plan, which was started in 2022, is still being implemented for the City of Banja Luka.

Considering all above mentioned, we can conclude that Bosnia and Herzegovina has so far taken certain steps to strengthen and develop a sustainable transport system, in terms of creating a policy and a strategic document for the transport sector. It is obviously that the concept of sustainable mobility is recognized and supported,

but without defining it specific measures, actions, key bearers of activities and the implementation period.

The fact is that the implementation of certain measures requires strong financial support. However, the Economic and Investment Plan for the Western Balkans provides up to 9 billion € will be mobilized to stimulate economic growth and support reforms [5]. A significant amount will be concentrated on increasing traffic and energy connectivity, on the green transition, especially decarbonization and digital transformation, which the Western Balkans, including Bosnia and Herzegovina, should use in order to make its transport sector sustainable, smart and resilient [15].

## 6 Conclusion

Climate changes affecting Europe, and especially the countries of the Western Balkans, are most often associated with mobility, i.e. traffic, which is a source of great pressure on the environment. Because of that it is necessary to make this sector cleaner through carefully selected steps, achievable actions and measures much safer, smarter, greener, more resilient, competitive and sustainable.

Committing to achieve climate neutrality by 2050 and fulfill its obligations under the international Paris Agreement, the EU has created a Sustainable and Smart Mobility Strategy structured around three key goals: make the European transport system sustainable, smart and resilient. Strategy is based on an Action plan with concrete measures with 10 initiatives and 82 measures that will guide work in the coming years, and through a cross-section of goals for 2030, 2035 and 2050. By creating the Strategy, the EU initiated the transition to net zero emissions, helping and inspiring others to follow the same path. The Western Balkans joined this initiative by signing the Sofia Declaration on the Green Program for the Western Balkans and the Strategy for the Western Balkans was adopted, which set common goals and coordinated approach in order to create sustainable and smart mobility of the Western Balkans.

Considering that the Road Map as a part of this Strategy is intended as a leading document for the region in the preparation of the national strategy, it can be said that Bosnia and Herzegovina has a good foundation for national strategy of

sustainable and smart mobility creation and adoption, based on all previous activities regarding the creation of the policy and strategic document of the transport sector, as well as monitoring and analysis of the transport sector environmental impact.

## References

- [1] Fetting, C., “The European Green Deal”, *ESDN Report*, ESDN Office, Vienna, 2020, p.p. 4-12
- [2] European Commission, “Sustainable and Smart Mobility Strategy – putting European transport on track for the future”, *Communication from the Commission to the European Parliament*, European economic and social Committee and the Committee of the Regions, COM, Brussels, 2020, pp. 1-9
- [3] CEDES, Westport Consulting, NTSI-INSTITUT, “Sustainable Urban Mobility Plan of the City and Canton Sarajevo SUMP”, *Document*, (GIZ) GmbH, Sarajevo, 2020, pp. 10
- [4] Commission of the European Communities, “Action Plan on Urban Mobility”, *Communication from the Commission to the European Parliament*, 490 final, European economic and social Committee and the Committee of the Regions, Brussels, 2009, pp. 2-7
- [5] Transport Community Treaty Permanent Secretariat, “Strategy for sustainable and smart mobility in the Western Balkans”, *Staff working document*, Belgrade, 2021, pp. 1-22
- [6] Regional Cooperation Council, “Action plan for the implementation of the Sofia Declaration on the Green Program for the Western Balkans for the period 2021-2030”, *Document*, RCC, 2021, pp.14
- [7] Lindov, O., Omerhodžić, A., Mujić, A., & Gadžo, E., “Sustainable Urban Mobility Living Lab: Case study Sarajevo”. *Transportation Research Proceedings*, Sarajevo, 2022, pp. 64, 25-33.

- [8] Ministry of Communication and Traffic of Bosnia and Herzegovina, “B&H Framework Transport Strategy”, Sarajevo, Bosnia and Herzegovina, 2016, pp.93-99
- [9] Energy Community Secretariat. Available at: <https://www.energy-community.org> (access date 26.03.2023.)
- [10] Transport Community Secretariat. Available at: <https://www.transport-community.org> (access date 26.03.2023.)
- [11] B&H ESAP 2030+. Available at: <https://esap.ba> (access date 26.03.2023.)
- [12] Ministry of Communication and Traffic of Bosnia and Herzegovina, “B&H Framework Transport Policy for the period 2015-2030”, Sarajevo, Bosnia and Herzegovina, 2015, pp.9-12
- [13] United Nations Development Programme. Available at: <https://www.undp.org> (access date 26.03.2023.)
- [14] Federation of Bosnia and Herzegovina municipalities and cities Union. Available at: <https://www.sogfbih.ba> (access date 26.03.2023.)
- [15] Lindov, O., Bošnjak, D., Bušić, D., “Functionality and applicability of SUMP in urban environment”, *The tenth BH congress on transport infrastructure and transport*, Sarajevo, 2019, pp.2-6

# "Multimodal approach in the analysis of urban mobility"

Fadila Kiso<sup>1</sup>, MA-Samira Karičić<sup>2</sup>

<sup>1</sup> University of Sarajevo, Faculty of Traffic and Communications, Zmaja od Bosne 8, 71 000 Sarajevo

<sup>2</sup> IPSA INSTITUT, Put Života b.b., 71 000 Sarajevo

## Abstract

Urban mobility is an extremely complex issue. It is determined by a number of factors, among which traffic infrastructure, i.e. the city traffic network, stands out in terms of importance. For quality assessment of the functional capacity of city streets, it is necessary to conduct analysis by synthesis of all categories of traffic flows, i.e. modes of transport and travel that take place on the streets at the same time. The analysis is focused on all four categories of traffic flows on street surface, i.e. motor vehicle flows, pedestrian and cyclist flows, and the flow of urban public transport vehicles. In this paper, a multimodal approach that proposes an assessment of functional ability and degree of mobility was analyzed on city streets based on evaluation of implementation quality, i.e. levels of service for each mode of transport and their interaction, which leads to utilization of available traffic capacities to a certain degree through synthesis assessment.

**Keywords:** *Urban mobility; traffic infrastructure; motor vehicle flows; pedestrian and cyclist flows, the flow of urban public transport vehicle*

## 1. Introduction

This paper presents the results of research on mobility level assessment on urban streets for four dominant modes of transport.

The dominant modes of transport on urban streets are motorized vehicles, pedestrians, cyclists and urban passenger transport vehicles that share the street surface with other road users. In order to provide satisfactory mobility and balanced use of street capacities for all modes of transport, it is necessary to apply special methodologies to determine the level of service and evaluate the operation quality for each mode of transport.

Each methodology is used to assess the quality of service provided to road users traveling on urban streets. Operational decisions aimed at better conditions for one mode of transport could have adverse effects for other modes of transport.

The challenge for the analyst is to come up with a design and operating conditions for urban streets in such a way that all relevant modes of transport are reasonably accommodated. The four analyzed methodologies are intended to assist the analyst by providing an opportunity to assess the

performance of each mode of transport, as well as an assessment that takes the impacts of other modes of transport into account.

Performance evaluation of urban streets is conducted from the perspective of motorized vehicle drivers, pedestrians, cyclists and passengers in the urban public transport system. Thus, there are four methodologies under the following names: Motorized vehicle methodology; Pedestrian methodology; Bicycle methodology and Public transport system methodology. Synthesized, these methodologies may be used to assess performance of urban street capacities from a multimodal perspective.

## 2. Framework for multimodal mobility assessment

### 2.1. Defining of technical elements for the analysis of urban streets

For the purpose of analysis, the urban street is separated into individual elements that are physically adjacent and operate as a single entity in serving travelers. Two elements are commonly found on an urban street system: points and links.

---

Corresponding author: *Author (samira.karicic@ipsa-institut.com)*

© 2023 The Author(s). This work is licensed under a Creative Commons Attribution 4.0 International License.

A *point* is the boundary between links and is usually represented by an intersection or ramp terminal. A *link* is a length of roadway between two points. A link and its boundary intersections are referred to as a *segmento*. An urban street *facility* is a length of roadway that is composed of contiguous urban street segments and is typically functionally classified as an urban arterial or collector street.

At least one intersection (or ramp terminal) along the facility must have a type of control that can impose a legal requirement to stop or yield on the through movement. A significant change in one or more facility characteristics may indicate the end of one facility and the start of a second. These characteristics include cross-section features (e.g., number of through lanes, shoulder width, curb presence), annual average daily traffic volume, roadside development density and type, and vehicle speed.

## 2.2. Synthesis of procedures for multimodal mobility assessment

Urban street surface is commonly shared by different modes of transport. Depending on the

mode of transport, there are passengers in motorized vehicles, pedestrians, cyclists and passengers in urban public transport vehicles. Passengers' perceptions of service quality are a significant indicator of mobility, but they differ in many ways because each type of trip has a specific purpose, distance and expectations in terms of time and quality of realization.

Sharing an urban street requires different modes of transport to operate in close proximity, or sometimes even share the same street surface as is the case with at-grade junctions.

This sharing may be feasible when modes of transport are characterized by low demand volumes; however, acceptable operation for moderate to high volumes of traffic demand typically requires spatial separation of transport modes along the street and temporal separation (i.e., signal control) at intersections. Methodologies described in this paper may be used to simultaneously estimate the LOS (LEVEL OF SERVICE) provided to each mode of transport on an urban street. The framework for this evaluation is depicted in Figure 1.

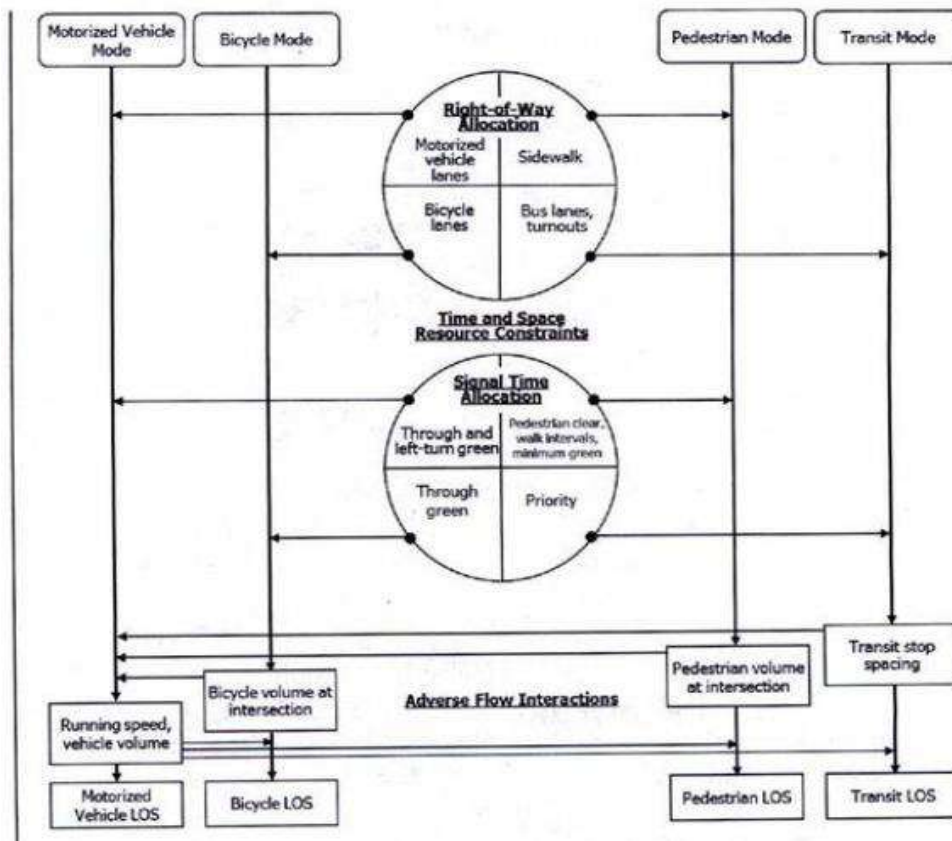

Fig. 1. Integrated Multimodal evaluation Framework in mobility analysis [1]



Figure 1 illustrates how modes of transport compete for limited right-of-way along the street and at intersections, as well as for limited signal time at intersections. Allocation of space to one transport mode for the purpose of giving right-of-way often requires a reduction (or elimination) of space for other modes of transport and a corresponding reduction in their quality of service. This is the most common consequence of changing signal design at intersections. The lower part of the Figure 1 illustrates the potential negative interactions between motorized vehicles and other modes of transport. As the volume or speed of the vehicular traffic flow increases, the LOS for other modes may decrease. If bicycle, pedestrian, or transit flows increase, the LOS for motorized vehicle traffic flows may decrease. In general, changes that alter resource allocation or flow interaction to improve LOS for one mode may adversely affect other modes of transport.

### 3. Conditions, scope and limitations of the multimodal mobility assessment

In accordance with recommendations of relevant literature ([3] – [4]), a multimodal approach in mobility assessment should be implemented by applying four methodologies that belong to each of the dominant modes of transport on urban streets. The dominant modes of transport are as follows:

- Motorized vehicle flows;
- Pedestrian flows;
- Bicycle flows, and
- Urban passenger transport flows [2].

Considering that there is no single procedure for evaluating all modes of transport on urban streets, the results of which would be directly transformed into the evaluation of urban street performance, four methodologies are used based on which it is possible to evaluate the governing influence on the functional capacity of the entire street in each specific case.

#### 3.1. Conditions for application of associated methodologies

The conditions under which each of the associated methodologies are applied are as follows:

- Signalized and TWSC intersections. All four methodologies may be used to evaluate the performance of an urban street segment with associated signalized or TWSC intersections. The methodology for motorized vehicles may also be used to evaluate a segment with AWSC intersections or with a controlled approach type such as roundabouts.
- The subject methodologies were actually developed with a focus on the conditions prevailing on arteries and collector streets. If they are used to evaluate local low-ranking streets, a careful approach to data verification is required.
- Steady flow conditions. The four methodologies are based on the analysis of constant traffic conditions and as such are not well adapted to the assessment of unstable conditions (e.g. congestion, queue overflows, protected plus permitted signal phases, etc.).
- Targeted road users. Together, four methodologies were developed to estimate LOS perceived by drivers, pedestrians, cyclists and passengers in urban transport. They were not developed to provide estimates of LOS as perceived by other road users (e.g., commercial vehicle drivers, car passengers, delivery vehicle drivers, or recreational vehicle drivers). However, it is likely that the perception of these road users largely coincides with the perception of those for whom the methodologies were primarily developed.
- Targeted modes of transport. The methodology for motorized vehicles flows treats mixed flows of cars, motorcycles, trucks, buses, etc. which has the highest percentage of passenger cars. Special methodologies treat walking, cycling and trips in public transport vehicles that operate on the street surface together with other categories of transport or on reserved lanes with stops along the road. Methodologies have not been developed to evaluate the performance of other modes of transportation such as the subway, electric bicycles, etc.
- Influences on the movement path. Road users' perception of the quality of service is influenced by many factors inside and outside the urban street cross section. However, with the multimodal approach in evaluation of urban streets mobility, factors outside the street cross section are excluded because these factors are outside the competence of traffic management on urban streets.
  - Mobility focus in motorized vehicle methodology. Motorized vehicle

methodology aims to facilitate the evaluation of mobility. Access to adjacent areas and facilities by car is not directly evaluated by this methodology. Regardless of segment availability, justification should also be taken into account when evaluating, as well as the function and design of access to contents outside the street. Often, factors favoring mobility reflect constraints on access to urban street and vice versa.

- Focus on the "typical pedestrian" in pedestrian methodology. Pedestrian methodology is not designed to reflect perceptions of any specific subset of pedestrians, such as pedestrians with disabilities.

### 3.2. Limitations in methodology application

In general, the methodologies described in this paper may be used to evaluate performance of most traffic flows on urban street segments. They are not adapted to all conditions and all types of traffic control. Limitations in application arise due to the impossibility of quantifying all conditions or traffic control systems. The most common limitations in the application of the methodology for motorized and non-motorized trips are identified below. In case of intense impact of some limitations, analysts should apply alternative procedures and tools.

Application of the motorized vehicle methodology is limited if the following specific conditions exist:

1. Parking on the street surface along the subject street
  2. Street with a longitudinal grade
  3. Limited capacity between intersections in case of grade separated traffic facilities
  4. Any kind of restrictions on associated intersections
  5. Bicycle lanes within the street cross section
  6. Railway crossings etc.
  7. Restrictions for non-motorized journeys that include pedestrians, cyclists and passengers in public transport vehicles apply to the following conditions:
  8. Urban street segments connected by AWSC intersections or roundabouts
1. Unsignalized pedestrian crossings on any part of the segment
  2. Longitudinal grade greater than 2%

Significant influx of pedestrians in peak periods related to public transport stations and business facilities nearby

Points where a large number of vehicles cross the pedestrian or bicycle lane to access facilities such as parking garages.

### 3.3. Analysis type

The phrase *analysis type* is used to describe the purpose for which a methodology is used. Each purpose is associated with a different level of detail, since it relates to the precision of the input data, the number of default values used, and the desired accuracy of the results. Three analysis types are recognized in this paper:

- Operational
- Design, and
- Planning and preliminary engineering [1].

#### Operational Analysis

The objective of an operational analysis is to determine the LOS for current or near-term conditions when details of traffic volumes, geometry, and traffic control are known. All the methodology steps are implemented and all calculation procedures are applied to compute a wide range of performance measures. The operational analysis type will provide the most reliable results because it uses no (or minimal) default values.

#### Design Analysis

The objective of a design analysis is to identify the alternatives that operate at the target level of the specified performance measures (or provide a better level of performance). The analyst may then recommend the "best" design alternative after consideration of the full range of factors. The nature of the design analysis type depends on whether the boundary intersections are unsignalized or signalized. When the facility has unsignalized boundary intersections, the analyst specifies traffic conditions and target levels for a set of performance measures. The methodology is then applied by using an iterative approach in which alternative geometric conditions are separately evaluated.

When the facility has signalized boundary intersections, the design analysis type has two variations. Both require the specification of traffic conditions and target levels for a set of

performance measures. One variation requires the additional specification of the signalization conditions. The methodology is then applied by using an iterative approach in which alternative geometric conditions are separately evaluated.

The second variation of the design analysis requires the additional specification of geometric conditions. The methodology is then applied by using an iterative approach in which alternative signalization conditions are evaluated.

### Planning and Preliminary Engineering Analysis

The objective of a planning and preliminary engineering analysis can be (a) to determine the LOS for either a proposed facility or an existing facility in a future year or (b) to size the overall geometrics of a proposed facility [2].

The level of precision inherent in planning and preliminary engineering analyses is typically lower than for operational analyses because default values are often substituted for field-measured values of many of the input variables.

#### 3.4. Spatial and temporal limits for analyzing motion conditions

The methodologies described in this paper are typically used to evaluate an entire facility; however, for some specific conditions, evaluation of the entire facility may not be necessary. For these conditions, the appropriate segment or intersection chapter methodology may be used alone to evaluate selected segments or intersections. In general, the analyst determines the spatial scope of each analysis (e.g., one intersection, one segment, two segments, or all segments on the facility) on the basis of analysis objectives and agency directives. Evaluation of an individual segment or intersection may be acceptable when the segment or intersection is considered to operate in isolation from upstream signalized intersections. A segment or intersection that is effectively isolated experiences negligible influence from upstream signalized intersections. Flow on an isolated segment or at an isolated intersection is effectively random over the cycle, and no platoon pattern is discernible in the cyclic profile of arrivals. These characteristics are more likely to be found when (a) the nearest upstream signalized intersection is sufficiently distant from the subject

segment or intersection and (b) the subject segment or intersection, if signalized, is not coordinated with the upstream signal. A segment or intersection is sufficiently distant from the nearest upstream signal if an intermediate intersection uses STOP or YIELD control to regulate through traffic on the facility. If there is no intermediate STOP-or YIELD-controlled intersection, figure 2. can be used to obtain an indication of whether a segment or an intersection is sufficiently distant from an upstream signal. If the distance between signals is above the trend line, the subject intersection or segment is likely to operate as effectively isolated (provided that it is not coordinated with the upstream signal).

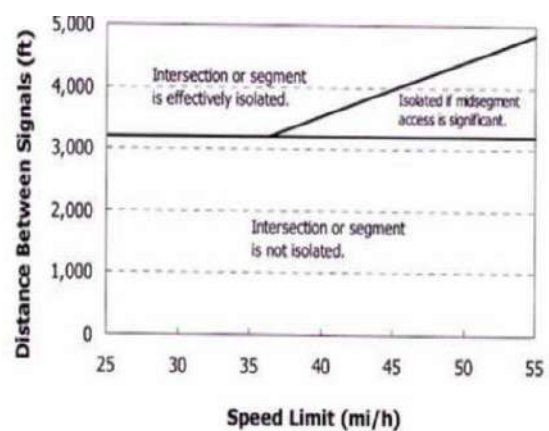

Fig. 2. Signal Spacing Associated with Effectively Isolated Operation [1]

The study period is the time interval represented by the performance evaluation. It consists of one or more consecutive analysis periods. An analysis period is the time interval evaluated by a single application of the methodology.

The methodology is based on the assumption that traffic conditions are steady during the analysis period (i.e., systematic change over time is negligible). For this reason, the duration of the analysis period is in the range of 0.25 to 1 h. The longer durations in this range are sometimes used for planning analyses. In general, the analyst should use caution with analysis periods that exceed 1 h because traffic conditions are not typically steady for long time periods and because the adverse impact of short peaks in traffic demand may not be detected in the evaluation.

#### 4. LOS CRITERIA

This subsection describes the LOS criteria for the motorized vehicle, pedestrian, bicycle, and transit modes. The criteria for the motorized vehicle mode are different from the criteria used for the other modes. Specifically, the criteria for the motorized vehicle mode are based on performance measures that are field-measurable and perceivable by travelers. With one exception, the criteria for the pedestrian and bicycle modes are based on scores reported by travelers indicating their perception of service quality. The exception is the pedestrian space measure (used

with the pedestrian mode), which is field measurable and perceivable by pedestrians. The criteria for the transit mode are based on measured changes in transit patronage due to changes in service quality.

##### 4.1. Input data for analysis

For the analysis of the flows of vehicles, pedestrians, cyclists and passengers in public transport vehicles, it is necessary to provide the input data contained in tables 1. and 2.

**Table 1.** Input data Requirements automobile modes [1]

Data category	Location	Input Data Element	Basic
Traffic characteristic	Boundary intersection	Demand flow rate	Movement group
	Segment	Access point flow rate Midsegment flow rate	Movement group Segment
Geometric design	Boundary intersection	Number of lanes Upstream intersection width Turn bay length	Movement group Intersection Segment approach
	Segment	Number of through lanes Number of lanes at access points Turn bay length at access points Segment length Restrictive median length Proportion of segment with curb Number of access point approaches	Segment Segment approach Segment approach Segment Segment Segment Segment
Other	Segment	Analysis period duration Speed limit	Segment Segment
Performance measures	Boundary intersection	Through control delay Through stopped vehicles 2nd and 3rd term back of queue size Capacity	Through movement group Through movement group Through movement group Movement group
	Segment	Midsegment delay Midsegment delay	Segment Segment

**Table 2.** Input data Requirements noneautomobile modes [1]

Data category	Location	Input Data Element	Pedestrian Mode	Bicycle Mode	Transit Mode
Traffic characteristic	Segment, transit	Dwell time Excess wait time Passenger trip length Transit frequency Passenger load factor			X X X X X
	Segment, other	Midsegment flow rate (motorized vehicles) Percent heavy vehicles Pedestrian flow rate Prop. of on-street parking occupied	X   X	X  X	

			X	X	
Geometric design	Segment, roadway	Downstream intersection width	X		
		Segment length	X	X	X
		Number of through lanes	X	X	
		Width of outside through lane	X	X	
		Width of bicycle lane	X	X	
		Width of paved outside shoulder	X	X	
		Median type and curb presence	X	X	
		No. of access point approaches		X	
	Segment, sidewalk	Presence of sidewalk	X		
		Total walkway width	X		
Effective width of fixed objects		X			
Buffer width		X			
Spacing of objects in buffer		X			
Other	Segment	Area type			X
		Pavement condition rating		X	
		Distance to nearest signal-controlled crossing	X		
		Legality of midsegment pedestrian crossing	X		
	Proportion of sidewalk adjacent to window, building, or fence	X			
	Transit stop	Transit stop location			X
		Transit stop position			X
Proportion of stops with shelters				X	
Proportion of stops with benches				X	
Performance measures	Segment	Motorized vehicle running speed	X	X	X
		Pedestrian LOS score for link			X
	Boundary intersection	Through control delay			X
		Reentry delay			X
		Effective green-to-cycle-length ratio			X
		(if signalized)			X
		Volume-to-capacity ratio (if roundabout)	X		
		Pedestrian delay		X	
		Bicycle delay	X		
		Pedestrian LOS score for intersection		X	
Bicycle LOS score for intersection					

#### 4.2. Level-of-Service criteria for motorized vehicle flows

Through-vehicle travel speed is used to characterize vehicular LOS for a given direction of travel along an urban street facility. This speed reflects the factors that influence running time along each link and the delay incurred by through vehicles at each boundary intersection. This performance measure indicates the degree of mobility provided by the facility. The following paragraphs characterize each service level.

**LOS A** describes primarily free-flow operation. Vehicles are completely unimpeded in their ability to maneuver within the traffic stream.

Control delay at the boundary intersections is minimal. The travel speed exceeds 80% of the base free-flow speed, and the volume-to-capacity ratio is no greater than 1.0.

**LOS B** describes reasonably unimpeded operation. The ability to maneuver within the traffic stream is only slightly restricted, and control delay at the boundary intersections is not significant. The travel speed is between 67% and 80% of the base free-flow speed, and the volume-to-capacity ratio is no greater than 1.0.

**LOS C** describes stable operation. The ability to maneuver and change lanes at midsegment locations may be more restricted than at LOS B.

Longer queues at the boundary intersections may contribute to lower travel speeds. The travel speeds between 50% and 67% of the base free-flow speed, and the volume-to-capacity ratio is no greater than 1.0.

**LOS D** indicates a less stable condition in which small increases in flow may cause substantial increases in delay and decreases in travel speed. This operation may be due to adverse signal progression, high volume, or inappropriate signal timing at the boundary intersections. The travel speed is between 40% and 50% of the base free-flow speed, and the volume-to-capacity ratio is no greater than 1.0.

**LOS E** is characterized by unstable operation and significant delay. Such operations may be due to some combination of adverse progression, high volume, and inappropriate signal timing at the boundary intersections. The travel speed is between 30% and 40% of the base free-flow speed, and the volume-to-capacity ratio is no greater than 1.0.

**LOS F** is characterized by flow at extremely low speed. Congestion is likely occurring at the boundary intersections, as indicated by high delay and extensive queuing. The travel speed is 30% or less of the base free-flow speed, or the volumes-to-capacity ratio is greater than 1.0.

Table 3. lists the LOS thresholds established for the motorized vehicle mode on urban streets. The threshold value is interpolated when the base free flow speed is between the values shown in the column headings of this table.

**Table 3.** LOS Criteria for motorized vehicle mode [1]

LOS	Travel Speed Threshold by Base Free-Flow Speed (mi/h)							Volume to Capacity Ratio <sup>a</sup> ≤ 1.0
	55	50	45	40	35	30	25	
A	>44	>40	>36	>32	>28	>24	>20	
B	>37	>34	>30	>27	>23	>20	>17	
C	>28	>25	>23	>20	>15	>15	>13	
D	>22	>20	>18	>16	>12	>12	>10	
E	>17	>15	>14	>12	>9	>9	>8	
F	≤17	≤15	≤14	≤12	≤9	≤9	≤8	

### 4.3. Level-of-Service criteria for pedestrian flows

Historically, this manual has used a single performance measure as the basis for defining LOS. However, research documented in Chapter 5, Quality and Level-of-Service Concepts, indicates that travellers consider a wide variety of factors in assessing the quality of service provided to them. Some of these factors can be described as performance measures (e.g., speed), and others can be considered basic descriptors of the urban street character (e.g., sidewalk width). The

methodologies in Chapter 18, Urban Street Segments, and Chapter 19, Signalized Intersections, mathematically combine these factors into a score for the segment or intersection, respectively. This score is then used in this chapter to determine the LOS that is provided for a given direction of travel along a facility [6].

Table 4. lists the range of scores associated with each LOS for the pedestrian travel mode. The LOS for this mode is determined by consideration of both the LOS score and the average pedestrian space on the sidewalk. The applicable LOS for an evaluation is determined from the table by finding the intersection of the row corresponding to the computed score value and the column corresponding to the computed space value.

**Table 4.** LOS Criteria for Pedestrian Mode [1]

Pedestrian LOS Score	LOS by Average Pedestrian Space (ft <sup>2</sup> /p)					
	>60	>40-60	>24-40	>15-24	>8.0-15	≤8.0
≤2.00	A	B	C	D	E	F
>2.00 – 2.75	B	B	C	D	E	F
>2.75 – 3.5	C	C	C	D	E	F
>3.5 – 4.25	D	D	D	D	E	F
>4.25 – 5.00	E	E	E	E	E	F
>5.00	F	F	F	F	F	F

The association between LOS score and LOS is based on traveler perception research. Travelers were asked to rate the quality of service associated with a specific trip along an urban street. The letter A was used to represent the best quality of service, and the letter F was used to represent the worst quality of service. "Best" and "worst" were left undefined, allowing respondents to identify the best and worst conditions on the basis of their traveling experience and perception of service quality.

### 4.4. Level-of-Service criteria for bicycle and transit modes

Table 5. lists the range of scores that are associated with each LOS for the bicycle and transit modes. This exhibit is also applicable for determining pedestrian LOS when a sidewalk is not available.

**Table 5:** LOS Criteria for bicycle and Transit Modes [1]

LOS	LOS Score
A	≤2.00
B	>2.00 – 2.75
C	>2.75 – 3.5
D	>3.5 – 4.25
E	>4.25 – 5.00
F	>5.00

## 5. Conclusion

This section identifies the conditions for which each methodology is applicable.

- **Boundary intersections.** AH methodologies can be used to evaluate facility performance with signalized or two-way STOP-controlled boundary intersections. In the latter case, the cross street is STOP-controlled. The motorized vehicle methodology can also be used to evaluate performance with all-way STOP-or YIELD-controlled (e.g., roundabout) boundary intersections.

- **Street types.** The four methodologies were developed with a focus on arterial and collector street conditions. If a methodology is used to evaluate a local street, the performance estimates should be carefully reviewed for accuracy.

- **Flow conditions.** The four methodologies are based on the analysis of steady traffic conditions and are not well suited to the evaluation of unsteady conditions (e.g., congestion, cyclic spillback, signal preemption).

- **Target road users.** Collectively, the four methodologies were developed to estimate the LOS perceived by motorized vehicle drivers, pedestrians, bicyclists, and transit passengers. They were not developed to provide an estimate of the LOS perceived by other road users (e.g., commercial vehicle drivers, automobile passengers, delivery truck drivers, or recreational vehicle drivers). However, the perceptions of these other road users are likely to be reasonably well represented by the road users for whom the methodologies were developed.

- **Influences in the right-of-way.** A road user's perception of quality of service is influenced by many factors inside and outside of the urban street right of way. However, the methodologies in this chapter were specifically constructed to exclude factors that are outside of the right-of-way (e.g. buildings, parking lots, scenery, or landscaped yards) that might influence a traveler's perspective. This approach was followed because factors outside of the right-of way are not under the direct control of the agency operating the street.

## Reference

[1] A.L., K M., and G.L., “User-based representation of time-resolved multimodal public

transportation networks”, Royal Society Open Science, 2016.

[2] A. A., M. S., and M.Y., “A Multilayer perspective for the analysis of urban transportation systems” Scientific Reports, 2017.

[3] .

[4] B. D., “Unsustainable transport: city transport in the new century”, Taylor & Francis, 2005.

[5] B. I., M. B., and L.V., “General scores for accessibility and inequality measures in urban areas”, Royal Society Open Science, 2019.

[6] B. G., “Street Network Models and Indicators for Every Urban Area in the World”, Geographical Analysis, 2021.

[7] D.M., P.M. A., and A. A.. “A tool for multilayer analysis and visualization of networks” Journal of Complex Networks, 2015.

[8] Highway Capacity Manual-HCM,2010.

[9] Highway Capacity Manual-HCM,2016.

[10] L. G., N. O., , L. A., M. S. , Michael S.,Federico Battiston” Multimodal urban mobility and multilayer transport networks, 2021.

[11] V.A., F.J., K.O., D. L., P. J., A. D. , “Little & UITP,” Future of Urban Mobility 2.0, Full Study, 2014.

[12] <https://euinfo.ba/en/european-mobility-week-multimodality-for-sustainable-urban-mobility/>

# Quality of Experience of Future ICT-based Logistics and Transport Systems

Sabina Baraković<sup>1</sup>, Jasmina Baraković Husić<sup>2</sup>

<sup>1</sup>University of Sarajevo, Faculty of Traffic and Communication, 71000 Sarajevo, B&H

<sup>2</sup>University of Sarajevo, Faculty of Electrical Engineering, 71000 Sarajevo, B&H

## Abstract

Quality of experience (QoE) is a multidimensional concept that has been in the focus of the research community for quite some time, especially after the rapid development of information and communication technology (ICT). It has been examined in many contexts (web, telecommunications, economy, medicine, etc.), for different media types (text, audio, video, augmented/virtual reality, etc.) and systems in various domains. Given that logistics and transport is a potent ICT-based domain for research activity in the future, in order to ease and improve the investigation of QoE in the contexts of logistics and transport, we aim to sum the recommendations and lessons learned for the investigation of QoE on the basis of our existing research. These suggestions cover how to treat the concept of QoE and relate it to other fields, techniques and environments to examine and treat QoE, as well as future technologies that need to be included. We provide insight into how these challenges can affect examination of QoE in logistics and transport and discuss ways to overcome them.

**Keywords:** Examination, Future, ICT, Logistics, Quality of experience, Transport

## 1 Introduction

Logistics and transport systems are critical components of prosperous economy allowing the movement of people, services, and goods as efficiently as possible. To improve the efficiency and provide better, personalized delivery of services while maintaining certain quality, there is an ever-increasing use of information and communication technology (ICT) in this context. Application of ICTs in logistics and transport systems has been studied so far in terms of automated identification technologies and data collection (e.g., radio frequency identification (RFID), global positioning systems (GPS), near field communication (NFC), quick response (QR)), data exchange technologies (e.g., Bluetooth low energy (BLE), wireless sensor networks (WSN), wireless fidelity (Wi-Fi)), and internet of things (IoT) and cloud computing environment [1]. These and emerging technologies have a great potential to improve the user experience (UX). Therefore, the use of interoperable ICTs should be encouraged further as a matter of priority. When fully utilized, it is

expected that these technologies hold the key to a personalized, memorable, and convenient user experience. As logistics and transport domain tends to become more user oriented, it is necessary to understand the impact the user experience and its quality have in this context. In this paper, ICT-based logistics and transport systems refer to systems that apply modern ICTs and solutions.

The user experience and quality of experience (QoE) domains overlap because they have almost same goal, i.e., to understand and improve the user perception and overall satisfaction with the service [2][3]. Improving the user experience and its quality is the driving strategy in logistic and transport ICT-based systems which have been previously investigated to some extent. Therefore, the aim of this paper is to summarize lessons learned from previous research and provide recommendations for future research of QoE in ICT-based logistics and transport systems.

The rest of the paper is organized as follows. Section 2 introduces the concept of QoE, whereas

---

Corresponding author: Sabina Baraković (sabina.barakovic@fsk.unsa.ba)

© 2021 The Author(s). This work is licensed under a Creative Commons Attribution 4.0 International License.



section 3 provides an insight into the techniques and testing environments used for QoE examination. Relationship between QoE and other fields (e.g., cyber security, quality of life (QoL)) and future technologies (i.e., 5G, 6G, augmented reality (AR)/virtual reality (VR), web of things (WoT)) are described in section 4 and section 5, respectively. Finally, section 6 summarizes the paper.

## 2 Quality of Experience Concept

This section tends to give high-level foundation recommendations related to the concept of QoE that can be implemented in the context of ICT-based logistics and transport systems. These four suggestions are based on the results of our QoE research done so far in domain of web, video, united communications, etc., i.e., media that can be used in ICT-based logistics and transport systems [2]-[26].

### Item 1: Multidimensional concept

Regardless of the context (i.e., domain, system, media, etc.) in which is examined, QoE of ICT-based logistics and transport systems should be considered as a multidimensional concept that can be decomposed into multiple perceptual QoE dimensions which are impacted by various QoE factors. Having a multidimensional approach to QoE may improve its better modelling, monitoring, assessment, optimization, control, and management.

### Item 2: QoE management framework

QoE management framework for ICT-based logistics and transport systems should comprise of three main phases: (i) modelling, (ii) monitoring and measurement, and (iii) optimization and control. The selection of the key factors and dimensions specific for logistics and transport systems context is the most important issue in modelling QoE. The main challenges related to QoE monitoring and measurement are: what, where, when, and how to collect data. Similarly, the what, where, when, and how to improve QoE summarize the challenges of the QoE optimization and control phase. These last two phases have to be tailored to the context of these systems as well.

### Item 3: QoE dimensions and factors

For ICT-based logistics and transport systems, the various specific and important perceptual QoE

dimensions, i.e., perceivable, recognizable, and nameable characteristics of the individual's experience of a service which contributes to its quality, and wide spectrum of specific QoE factors, i.e., any characteristic of a user, system, service, application or context whose actual state or setting may have influence on the QoE, should be considered.

It is reasonable that not all perceptual QoE dimensions and QoE factors important for ICT-based logistics and transport systems can be identified and considered, but the key ones should be identified and examined. Perceptual QoE dimensions should be contextualized for system usage, while QoE factors should stem from human, system, and context groups.

### Item 4: Quantification of QoE relations and interplays

In order to gain deeper understanding of QoE for ICT-based logistics and transport systems, the relationships and interplays of wide spectrum of identified QoE factors, various perceptual QoE dimensions, and QoE should be quantified. Based on those models one can further have better predictions, monitoring and measurement, and consequently optimize QoE in a more effective manner.

## 3 Quality of Experience Examination

This section continues with discussion related to the examination of QoE for ICT-based logistics and transport systems. The addressed three learned-lessons points are also based on the activities in our QoE research done so far in domain of web, video, united communications, etc. and tend to ease the decision making process while investigating QoE [2]-[26].

### Item 5: QoE data collection

After key QoE factors and perceptual QoE dimensions are identified in the modelling process of QoE for ICT-based logistics and transport systems, one must take care of granularity and degrees up to which the factors are manipulated. It is recommended to have more degrees of factor manipulation, i.e., greater granularity, which contributes finally to more accurate prediction models, since the more input levels of variable we have, the model will be able to better capture the variation. The same approach should be applied to data collection in monitoring and measurement process. Data collection in general largely

depends on the selected QoE impact factors in logistics and transport systems context.

In addition, one can differentiate between objective and subjective methods for data collection. Objective ones collect data solely from objective quality measurement or indices, while subjective data collection processes must have specified the methodology to be used, identification of the dependent and independent variables to be considered, user test participants, testing scenarios, testing environment, and rating scales.

Also, important thing is the selection of data collection scales (Likert scales, mean opinion score (MOS), etc.) or development of questionnaires (post-study system usability questionnaire (PSSUQ), etc.) which need to be in accordance with the selected perceptual QoE dimensions since they are included in order to capture the perceptions and QoE.

#### **Item 6: QoE experiment environment**

When conducting the studies dealing with QoE of ICT-based logistics and transport systems one has several options: lab, field, or crowdsourcing environment. As already discussed in the literature, each of the options has its own advantages and disadvantages. The choice usually should depend on the timing of the study. It is advisable to have both lab and real-world test in order to gain more quality results and conclusions that can be generalized. Of course, it is important to note that field and crowdsourcing tests can gather large amounts of data with less cost and time in comparison to laboratory-based ones, but controlling the experiment represents the challenge. Of course, it is of great importance to stress that each study should have as much as participants as possible in order to avoid drawing misleading or inaccurate conclusions often present in human related studies. In addition, the researchers should carefully design the testing scenarios which should capture the perceptions and QoE.

#### **Item 7: QoE data processing**

When processing data, one can use three different techniques: mathematics, statistics, and machine learning. Each of these methods have their own pros and cons in dependence of the required final outcome. Therefore, it is crucial to know what one wants as a result of data processing and choose a method. Using mathematics means one wants to present

relationships between different variables, parameters, and defined limitations by using differential equations and algebraic and logical statements as auxiliary relations. Using statistics means using mathematical models and statistical assumptions in order to generate data patterns and predictions related to the real world. This method helps researchers to approach to data in a strategic way and relate one or more independent variables to other dependent variables, but requires understanding the outcomes and results prior to its usage. Machine learning represents the ability of the algorithm to generalize based on the previously learned connections between the data. This method is looking for patterns hidden in data independently of all assumptions.

## **4 Quality of Experience and Other Fields**

QoE is a broad concept related to humans and their perceptions since they are quality meters today and will remain in the future. That is why it cannot be considered in isolated fashion. This section gives several points when it comes to QoE research related to other fields, but the cases where QoE should be examined and domains to which it should be related are much wider and will be even more in the upcoming period [23][24][27]-[29].

#### **Item 8: Multidisciplinary concept**

Although QoE should be, as a concept, considered as multidimensional, it is important to stress that it is also needs multidisciplinary approach since it is human-oriented technology-related, and context-dependent. This means that researchers from all relevant disciplines should be included in QoE research depending on the context. For example, in ICT-based logistics and transport systems case, one should include the following disciplines: technology, engineering, psychology, design, security, and transport. Therefore, depending on the nature and the domain of the system being considered, QoE should be addressed in a multidisciplinary manner. Also, various other fields offering wide variety of factors should be included when addressing QoE. For example, in logistics and transport systems, energy efficiency or security also can be examined as influencing factors.

#### **Item 9: QoE and life**

Given that QoE is related to humans and their opinion on the technology, it ultimately should improve their QoL. QoL is very complex and it can be improved in many ways, but QoE channel is one of them. Nowadays our lives vastly depend on the technology which is rapidly developing thereby changing the way we live. The ultimate goal of the technology, including logistics and transport domain, should be the improvement of QoL, but in order to achieve that, one must have quality experience with it. Therefore, in order to have adequate ICT-based logistics and transport systems which will improve the lives of people in general (QoL), one must address the QoE when using them.

#### **Item 10: QoE and cyber security**

With the outburst of COVID-19 pandemic and rapid development and dominance of technology, threats and attacks against the digital infrastructure have exploded due to increased usage of cyber space and low cyber hygiene (awareness, behavior, and knowledge). Therefore, cyber security became a prominent notion in everyday human life and technology with no intention to pull back, but quite the opposite, i.e., to rise. This means that it cannot be ignored by future QoE studies related to any ICT-based system either as QoE influence factor or perceptual QoE dimension.

## **5 Quality of Experience and Future Technologies**

This section provides an insight into the relationship between QoE and future technologies in the context logistics and transport.

#### **Item 11: QoE and 5G**

5G opens new opportunities to transform the logistics and transport. With the advent of 5G services (i.e., eMBB (enhanced Mobile Broadband), URLLC (Ultra Reliable Low Latency Communications), and mMTC (massive Machine Type Communications)), the new requirements in terms of methodology and set of parameters for QoE examination have appeared. The traditional QoE concept is appropriate for eMBB, but not for URLLC and mMTC because the end-user is a machine, not a human. This requires a machine QoE to be defined. The challenge of how to quantify QoE needs to be addressed. Thus, a new understanding of what constitutes QoE is needed which calls for a

revised concept of QoE and new techniques for QoE examination [30].

#### **Item 12: QoE and 6G**

6G will provide extensions and combinations of 5G services (i.e., eMBB+, URLLC+, and mMTC+) while introducing two new usage scenarios, i.e., sensing and artificial intelligence (AI). This means that 6G will be intelligently combined with 5G allowing end-users to customize their own QoE. It is expected that data analytics and AI will improve the QoE and enable its personalization. 6G will keep on with the 5G trend of defining QoE over individual parameters [31]. This will be beneficial for ICT-based logistics and transport systems where the importance of user-centricity has been already recognized.

#### **Item 13: QoE and XR**

Providing QoE for extended reality (XR) applications, including AR, VR, and mixed reality (MR) is challenging. In such applications, QoE is critical as their usage can cause the sickness or nausea. Moreover, these are multimedia applications which incorporate audio, video, interaction, and environments [32]. The QoE of such applications is affected by many influence factors whose relationship to QoE should be quantified. Since the logistics and transport sector is one of the first sectors to make use of XR, it is important to define the QoE requirements in terms of performance and methodology in this context.

#### **Item 14: QoE and WoT**

Using the WoT in ICT-based logistics and transport systems provides many benefits to QoE which can either neutralize or avoid all negative influence factors. Describing the relationship between different influence factors and QoE, it is possible to identify the importance of distinct influence factors, develop accurate prediction models of QoE, and find the relation between QoE and QoL in WoT context. All interested parties may use this knowledge to understand how their work affects others in WoT delivery chain or how others are affecting their processes. It is important to find how WoT will improve QoL, model the relationship between QoL and QoE, and extend the multidimensional QoE models in the WoT context for logistics and transport domain [27].

## 6 Conclusions

Ever-increasing usage of ICTs in logistics and transport systems provides opportunities to improve user experience and its quality. Being the potent domain for future research, this paper has summarized the recommendations and lessons learned for the examination of QoE based on our previous research activities. Thus, the contribution of this paper is three-fold. Firstly, we have given the high-level recommendations related to the concept of QoE of ICT-based logistics and transport systems based on our QoE research findings related to various media that can be used in this context (Section 2). Secondly, we have discussed the examination of QoE for ICT-based logistics and transport systems in terms of QoE data collection, QoE experiment environment, and QoE data processing (Section 3). Thirdly, we have considered multidisciplinary concept of QoE in relation to other fields (i.e., QoL and cyber security) and future technologies (i.e., 5G, 6G, XR, WoT) and steps (Sections 4 and 5), while providing insight how they can impact the QoE examination in logistics and transport domain.

Future research in the context of investigating the QoE for future ICT-based logistics and transport systems should identify the important services to be addressed. Those services should include future ICT technologies (e.g., 5G, 6G, XR, WoT). After the identification, one can consider our recommendations and discussed items when treating the QoE, i.e., address it as a multidimensional concept, manage (model, monitor, and optimize) QoE, and investigate QoE accordingly by using multidisciplinary approach and in new environments.

## References

1. D. Peraković, M. Periša, R.S. Sente, “New Challenges of ICT Usage in Transport and Logistics,” in *Proceedings of the 6th International Conference Transport and Logistics (TIL 2017)*, Niš, Serbia, 2017. Available at: <http://til.masfak.ni.ac.rs/images/til-pedja/1.1.pdf>
2. S. Baraković, L. Skorin-Kapov, “Multidimensional Modelling of Quality of Experience in Mobile Web Browsing,” *Computers in Human Behavior*, vol. 50, pp. 314-322. 2015. DOI: 10.1016/j.chb.2015.03.071.
3. S. Baraković, L. Skorin-Kapov, “Modelling the relationship between design/performance factors and perceptual features contributing to Quality of Experience for mobile Web browsing,” *Computers in Human Behavior*, vol. 74C, pp. 311-329. 2017. DOI: 10.1016/j.chb.2017.04.046.
4. S. Baraković, J. Baraković, H. Bajrić, “QoE Dimensions and QoE Measurement of NGN Services,” in *Proceedings of the 18th Telecommunications Forum (TELFOR 2010)*, Belgrade, Serbia, 2010. Available at: [http://www.telfor.rs/files/radovi/TELFOR2010\\_01\\_05.pdf](http://www.telfor.rs/files/radovi/TELFOR2010_01_05.pdf).
5. J. Baraković Husić, S. Baraković, A. Veispahić, “What Factors Influence the Quality of Experience for WebRTC Video Calls?,” in *Proceedings of the 40th International Convention on Information and Communication Technology, Electronics and Microelectronics (MIPRO 2017)*, Opatija, Croatia, 2017. DOI: 10.23919/MIPRO.2017.7973463.
6. J. Baraković Husić, S. Baraković, S. Muminović, “Is There Any Impact of Human Influence Factors on Quality of Experience?,” in *Proceedings of the 40th International Convention on Information and Communication Technology, Electronics and Microelectronics (MIPRO 2017)*, Opatija, Croatia, 2017. DOI: 10.23919/MIPRO.2017.7973464.
7. L. Leveque, H. Liu, S. Baraković, J. Baraković Husić, A. Kumcu, Lj. Platisa, M. Martini, R. Rodrigues, A. Pinheiro, M. Outtas, L. Zhang, A. Skodras, “On the Subjective Assessment of the Perceptual Quality of Medical Images and Videos,” in *Proceedings of the 10th International Conference on Quality of Multimedia Experience (QoMEX 2018)*, Sardinia, Italy, 2018. DOI: 10.1109/QoMEX.2018.8463297.
8. T. Begluk, J. Baraković Husić, S. Baraković, “Machine learning-based QoE prediction for video streaming over LTE network,” in: *Proceedings of the 17th International Symposium INFOTEH-JAHORINA (INFOTEH 2018)*, Jahorina, Bosnia and Herzegovina, 2018. DOI: 10.1109/INFOTEH.2018.8345519.
9. D. Golić, J. Baraković Husić, S. Baraković, “Impact of Mobile Ad-hoc Network Parameters on Quality of Experience for Video Streaming,” in *Proceedings of the 17th International Symposium INFOTEH-JAHORINA (INFOTEH 2018)*, Jahorina, Bosnia and Herzegovina, 2018. DOI: 10.1109/INFOTEH.2018.8345520.
10. J. Baraković Husić, E. Alagić, S. Baraković, M. Mrkaja, “The Influence of Task Complexity and Duration when Testing QoE in WebRTC,” in *Proceedings of 18th International Symposium INFOTEH-JAHORINA (INFOTEH 2019)*, Jahorina, Bosnia and Herzegovina, 2019. DOI: 10.1109/INFOTEH.2019.8717657.
11. J. Baraković Husić, S. Baraković, I. Osmanović, “Subjective and Objective QoE Measurement for H.265/HEVC Video Streaming over LTE,” in *Springer Lecture Notes in Networks and Systems (LNNS), International Symposium on Innovative and Interdisciplinary Applications of Advanced Technologies (IAT 2019)*, Sarajevo, Bosnia and Herzegovina, 2019. DOI: 10.1007/978-3-030-24986-1\_34.

12. M. Bahhodžić, J. Baraković Husić, S. Baraković, "The Influence of System Factors on QoE for WebRTC Video Communication," in *Springer Lecture Notes in Networks and Systems (LNNS), International Symposium on Innovative and Interdisciplinary Applications of Advanced Technologies (IAT 2020)*, Sarajevo, Bosnia and Herzegovina, 2020. DOI: 10.1007/978-3-030-54765-3\_17.
13. A. Karadža, J. Baraković Husić, S. Baraković, S. Nogo, "Multidimensional QoE Prediction of WebRTC Video Communication with Machine Learning," in *Springer Lecture Notes in Networks and Systems (LNNS), International Symposium on Innovative and Interdisciplinary Applications of Advanced Technologies (IAT 2020)*, Sarajevo, Bosnia and Herzegovina, 2020. DOI: 10.1007/978-3-030-54765-3\_18.
14. J. Baraković Husić, A. Alić, S. Baraković, M. Mrkaja, "QoE Prediction of WebRTC Video Calls Using Google Chrome Statistics," in *Proceedings of the 20<sup>th</sup> International Symposium INFOTEH-JAHORINA (INFOTEH 2021)*, Jahorina, Bosnia and Herzegovina, 2021. DOI: 10.1109/INFOTEH51037.2021.9400661.
15. S. Baraković, L. Skorin-Kapov, "Survey and Challenges of QoE Management Issues in Wireless Networks," *Journal of Computer Networks and Communications*. 2013. Available at: <http://www.hindawi.com/journals/jcnc/2013/165146/>. DOI: 10.1155/2013/165146.
16. S. Baraković, L. Skorin-Kapov, "Survey of Research on Quality of Experience for Web and mobile Web Browsing," *Quality and User Experience*, vol. 2, no. 6. 2017. DOI: 10.1007/s41233-017-0009-2.
17. I. Osmanović, J. Baraković Husić, S. Baraković, "Impact of Media-Related SIFs on QoE for H.265/HEVC Video Streaming," *Journal of Communications, Software and Systems*, vol. 14, no. 2, pp. 157-170. 2018. DOI: 10.24138/jcomss.v14i2.516.
18. J. Baraković Husić, S. Baraković, S. Kasumović, "The Influence of SIP Call Control Signalling on VoIP Quality of Experience," *Technical Gazette*, vol. 26, no. 6. 2019. DOI: 10.17559/TV-20180325195242
19. J. Baraković Husić, S. Baraković, E. Cero, N. Slamnik, M. Ocuz, A. Dedović, O. Zupcic, "Quality of Experience for Unified Communications: An Overview," *International Journal of Network Management*, vol. 30, no. 3. 2020. DOI: 10.1002/nem.2083.
20. J. Baraković Husić, S. Baraković, S. Kasumović, "Studying the Impact of SIP Message Differentiation on the Quality of VoIP Session Control Procedures," *IETE Technical Review*, vol. 38, no.5, pp. 499-510 2020. DOI: 10.1080/02564602.2020.1786472.
21. J. Baraković Husić, S. Baraković, O. Krejcar, P. Maresova, "Modelling of Quality of Experience for Web-based Unified Communications with Perceptual Dimensions," *Signal, Image and Video Processing*, vol. 15, pp. 977-985. 2021. DOI: 10.1007/s11760-020-01822-0.
22. J. Baraković Husić, S. Baraković, "Multidimensional Modelling of Quality of Experience for Video Streaming," *Computers in Human Behavior*, vol. 129, 107155. 2022. DOI: 10.1016/j.chb.2021.107155.
23. S. Baraković, J. Baraković Husić, "Cyber Hygiene Knowledge, Awareness, and Behavioral Practices of University Students," *Information Security Journal: A Global Perspective*. 2022. DOI: 10.1080/19393555.2022.2088428.
24. S. Baraković, J. Baraković Husić, "The Importance of Security Matters for Quality of Experience in Mobile Web Context," *International Journal of Human-Computer Interaction*. 2022. DOI: 10.1080/10447318.2022.2072454.
25. D. Vučić, S. Baraković, L. Skorin-Kapov, "Survey on User Perceived System Factors Influencing the QoE of Audiovisual Calls on Smartphones," *Multimedia Tools and Applications*. 2022. DOI: <https://doi.org/10.1007/s11042-022-14173-4>.
26. R. Schatz, S. Schwarzmann, T. Zinner, O. Dobrijević, E. Liotou, P. Pocta, S. Baraković, J. Baraković Husić, L. Skorin-Kapov, "QoE Management for Future Networks," in *Springer book on Autonomous Control for a Reliable Internet of Services: Methods, Models, Approaches, Techniques, Algorithms and Tools*. 2018.
27. S. Baraković, J. Baraković Husić, D. Maraj, A. Maraj, O. Krejcar, P. Maresova, F.J. Melero, "Quality of Life, Quality of Experience, and Security Perception in Web of Things: An Overview of Research Opportunities," *Electronics*, vol. 9, no. 4, pp. 700. 2020. DOI: 10.3390/electronics9040700.
28. E. Hodžić, S. Baraković, A. Kavazović, J. Baraković Husić, "Use of Information and Communication Technologies in Social Work Institutions in Extraordinary Circumstances," *Science, Engineering and Technology*, vol. 1, no. 2, pp. 8-15. 2021. DOI: 10.54327/set2021/v1.i2.13.
29. S. Baraković, J. Baraković Husić, "Cyber Security Perspective of Top Future Technologies," in *Building Cyber Resilience Against Hybrid Threats*, IOS Press, 2022, pp. 85-98.
30. J. Carpenter, "Testing 5G QoE: Use Cases, Services and A New QoE Paradigm (part 1)," *Rohde & Schwartz*. Accessed on March 23, 2023.
31. A-EM. Taha, "Quality of Experience in 6G Networks: Outlook and Challenges," *Journal of Sensor and Actuator Networks*, vol. 10, no. 1, pp. 11. 2021. DOI: 10.3390/jsan10010011.
32. V. Stoynov, A. Ivanov, D. Mihaylova, "Conceptual framework for quality assessment in human-centric 6G XR services," in *IOP Conf. Ser.: Mater. Sci. Eng. 1032 012009*, 2021. DOI: 10.1088/1757-899X/1032/1/012009.

# The role of smart sensors implemented in vehicles for traffic automation of the future

<sup>1</sup>Isak Karabegović, <sup>2</sup>Mehmed Mahmić, <sup>2</sup>Edina Karabegović, <sup>2</sup>Ermin Husak

<sup>1</sup>Academy of Sciences and Arts of Bosnia and Herzegovina, Bistrik 7, 71000 Sarajevo,  
Bosnia and Herzegovina

<sup>2</sup>Univesity of Bihać, Technical faculty Bihać, Ul.Irfana Ljubijankića bb,  
77000 Bihać, Bosnia and Herzegovina

## Abstract

The development of advanced technologies such as information-communication technology, sensor technology and computer technology lead to the transfer of information held by sensors to the microcontroller at any moment, so that software, as the primary medium for decision-making, can direct the vehicle to desired destination, thus improving the participation of all traffic members. Applications of smart sensors and mechatronic systems are represented in almost all devices and are at the forefront of technologies such as: traffic, railway and air transport systems. Nowadays, cars are very complex sophisticated electronic control systems and most innovations in the automotive industry have been achieved through electronics and the implementation of smart sensors. The development and research of advanced technologies has led to a significant progress. The best example is the automotive industry, where almost every high-end car has over 100 ordinary and smart sensors, 100-150 electric motors, network systems with thousands of signals, and over 70 microprocessors and microcontrollers. The aim is to achieve an increase in safety for all traffic users. The paper presents the trend of development and implementation of smart sensors in vehicles, as well as their development and research in the coming period.

**Keywords:** *car, advanced technologies, sensor, smart sensors, microprocessor, microcontroller.*

## 1 Introduction

Based on statistical data collected by the World Health Organization (WHO) [1], it is known that every year around 1.3 million people die in traffic worldwide, and that 20-50 million people suffer injuries caused by participation in traffic, either as cyclists, pedestrians, motorcyclists, drivers or passengers in vehicles. The largest number of victims were young people aged 5-29 (more men than women), so for example 73 % of all deaths are young men under the age of 25. Likewise, 93 % of deaths come from low and middle income countries. Many factors have an influence on the increase in traffic accidents, such as driving at high speed and driving under the influence of alcohol and

psychoactive substances. In addition to these factors, there are many other factors that have a negative impact on safety on roads such as: not using helmets when riding bicycles and motorcycles, not using seat belts and safety systems for children, the use of mobile phones, thus leading to impaired driving, unsafe vehicles, unsafe road infrastructure, etc. In order to reduce the number of people killed in traffic accidents and the number of injured traffic users, progress in modern technologies is very important, especially progress in the sensor technology in the automotive industry, i.e. mechatronic systems equipped with smart sensors, the so-called micro-machine and micro electro mechanical systems (MEMS). Their implementation began in 1981

---

Corresponding author: *Isak Karabegović (e-mail: isak1910@hotmail.com)*

© 2023 The Author(s). This work is licensed under a Creative Commons Attribution 4.0 International License.

with the introduction of a pressure sensor for controlling engine operation in vehicles. Their advantage is that they are miniature and use the latest basic technologies of Industry 4.0, so that drivers have all the necessary information to make a decision while driving at all times. In other words, the driver has the ability to make a decision even at the moment when he starts to make mistakes. Their implementation in vehicles is increasing and improving every day, as well as other road infrastructures that serve for the development of traffic. The implementation of micromechanical and micro electro mechanical systems (MEMS) and their connection with information communication technology in vehicles can be called intelligent transport system. It is designed to reduce travel time, improve performance, efficiency and safety in traffic.

## 2 Trend of development of “smart sensors”

A sensor (in Latin—sensus: sensation; sensation, sense) can be defined as a device that is part of a measuring system that measures a physical quantity (e.g. pressure, number of revolutions, displacement, temperature, speed, etc.) and gives an output signal that depends on the value of the measured quantity, turns it into a signal suitable for further processing, and most often into an electrical signal that serves as an input for system control.

Many companies in the world have developed different constructions of sensors for measuring different physical quantities. In the middle of the twentieth century, Samuel Bagno applied his patent for sensors used as burglar alarms. At the beginning of 1940s, Samuel Bagno began to research ultrasonic alarms. His research focused on a network of ultrasonic waves that were sent from the modem around the room and bounced off static objects back to the modem, so in the event of movement there would be interference waves and the modem would detect them and trigger the alarm.

The development and research in new technologies has progressed so much that sensors are used in all segments of our lives. The historical development of sensor technology is shown in Figure 1.

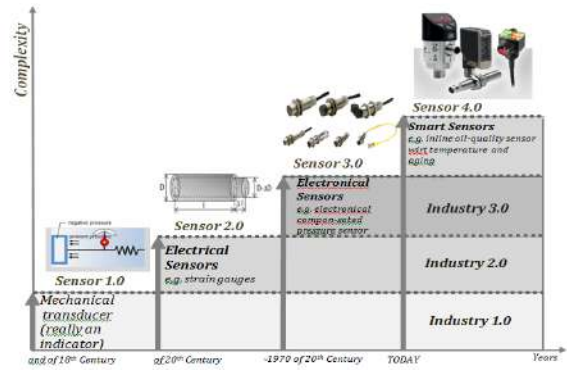

Fig. 1. Historical development of sensor technology

As Figure 1 shows, the development and implementation of smart sensors is an ongoing process, starting with mechanical sensors, electrical sensors, and electronic sensors. The standard defines smart sensors as sensors with little memory and a standardized physical connection that enable communication with the processor and data network [2,3,4]. The block diagram of the smart network sensor is shown in Figure 2.

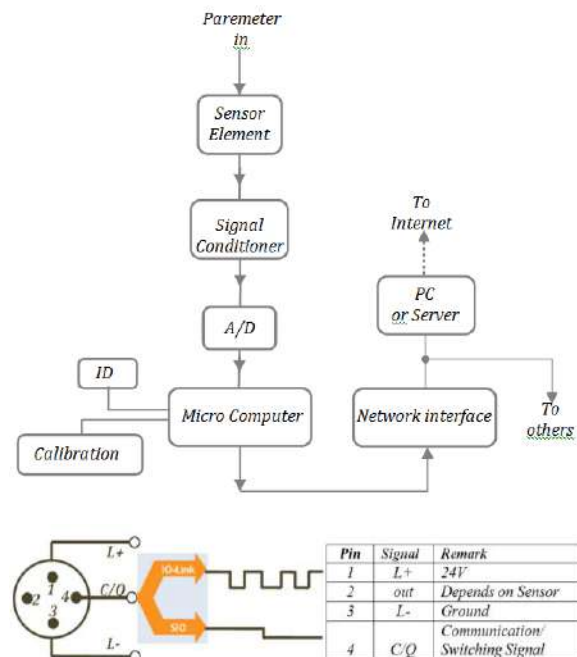

Fig. 2. Block diagram of a smart network sensor and schematic representation of a smart sensor

The block diagram of the smart network sensor shown in Figure 2 gives an insight into how the monitoring of the parameters is achieved, i.e., what other devices are necessary for monitoring the parameters. Based on Figure 2, which gives a schematic representation of a smart sensor, we see

that smart sensors with built-in IO-Link (the first standardized IO technology in the world (IEC 61131-9) for communication with sensors and actuators) work the same as standard I/O sensors that are used until the moment they are connected to the IO-Link Master. When the sensors are connected to the IO-Link Master, we are able to access all the advanced data and configuration capabilities that IO-Link can offer.

Many companies in the world have developed a whole range of smart sensors for temperature, pressure, speed, proximity sensors, photoelectric sensors, laser sensors, etc.



**Fig. 3.** Presentation of different constructive versions of smart sensors

The leader in implementation is the company ‘‘Rockwell Automation’’ from the USA. Due to limitations, we will show only a small part of the design solutions of smart sensors in Figure 3 [5,6].

The implementation of smart sensors is constantly increasing, and their application can be found in all segments of our environment. The reason for this is simplified application through the standardization of process data and the latest achievements of IO-Link devices with regard to the interface and integration with many different engineering tools. Their implementation can be found in houses, production processes and logistics of production processes, road infrastructure, vehicles, and other segments of our environment. In other words, it is impossible to imagine a product without a built-in sensor that gives us some information. The paper will pay more attention to the sensors used in the automotive industry.

**3 Implementation of smart sensors in the automotive industry**

In the automotive industry, until recently, sensors were implemented as direct devices that were used to measure coolant temperatures, fuel levels, oil pressure, etc. The development of electronics and information technology

accelerated the development and research in sensor technology so that development and progressive implementation of sensors took place. We can mention that, for example, in 1995, the number of implemented sensors in vehicles increased to ten, while the increase in 2010 was more than 30, as stated in [7]. Today, almost every high-end car has over 30 mechatronic systems (electrical/electronic systems) and over 100 smart sensors built into it. Many companies that produce sensors are investing in the development of new types of smart sensors, because they want to remain competitive on the global market. Every year around 100 million vehicles are produced in the world, and knowing the number of sensors implemented in one vehicle, one can see that the demand for sensors is enormous. Modern cars cannot be imagined without sensors. Figure 4 shows a set of different constructions of sensors that are implemented in vehicles.

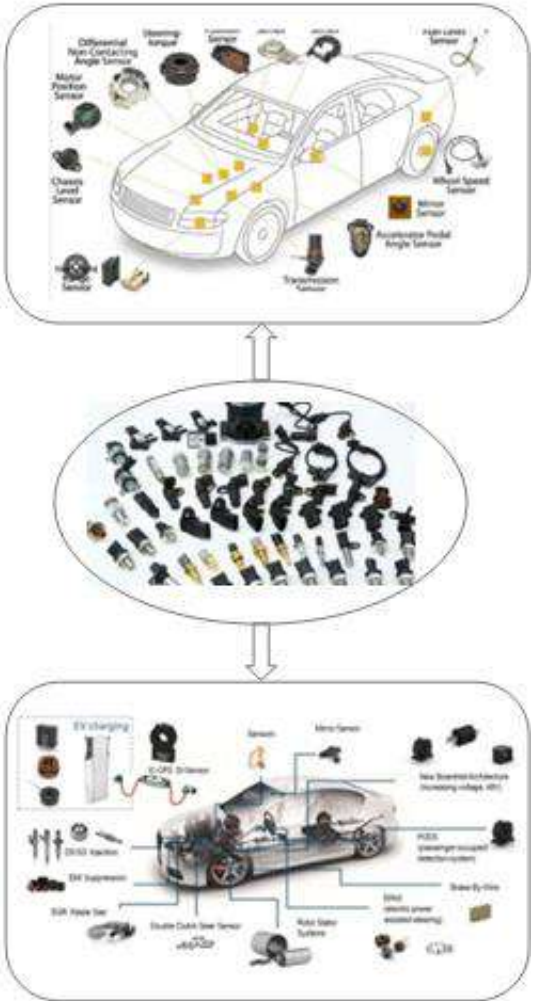

**Fig. 4.** Different constructive versions of smart sensors for implementation in vehicles [8,9,10]



Sensors in vehicles have the role of measuring and sending certain parameters in the vehicle to the central computer, after which data are processed and the vehicle is in operation state. This process happens in milliseconds and the reaction is very fast. Most often implemented sensors in vehicles are those for state, temperature, movement, position, proximity, distance, direction of movement, position, speed and acceleration (angular, linear), elapsed time and frequency, noise and vibration, liquid level, pressure (absolute, differential, atmospheric), flow, speed, force and moment, mechanical stress, orientation, fluid viscosity, electric voltage and current strength, humidity and rain, light intensity, gas concentration, etc. Of all the listed sensors, two are dominant, namely the intake manifold pressure sensor and the airbag accelerometer [11].

There are only two sensors in the world that are applied more than these, namely the read/write print head sensor and the disposable blood pressure sensor. Sensors implemented in vehicles must meet very strict requirements, such as temperature range from 40-125 ° (in the engine), vibrations that increase up to 10 years, accuracy, robustness, electromagnetic interference, compatibility, manufacturability, replaceability, including the low price [11].

Perhaps the best example of the conditions in which certain sensors work is a very important sensor that is found in practically all new cars intended for the European market. These are sensors of ABS devices that are located near the axle on all four wheels and are exposed to extreme heat or cold depending on the season. They have to withstand shocks and support the wheels and, at the same time, remain completely insensitive to moisture and chemical agents such as gasoline, oil, acid from the battery, coolants, etc. Only then can we understand the harsh conditions of sensor exploitation. In order to have an insight in the increase in the implementation of sensors and advanced technologies in vehicles, Figure 5 displays the increase in the implementation of sensors in vehicles every 20 years.

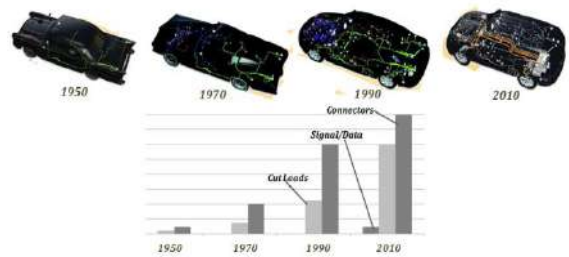

**Fig. 5.** Evolution of the implementation of advanced technologies in the automotive industry every 20 years for the period from 1950 to 2010 (signal/data, cables, connectors)

Based on Figure 5, we can conclude that the use of advanced technologies in 1950 was almost negligible and the number of signals/data and connectors was very small [12,13]. The development of advanced technologies contributed to the increase in the implementation of sensors in the automotive industry, which can be seen in Figure 5. In 2010, the implementation was so advanced that everything was wired and connected. The reason for this progress is the fact that consumers have an increasing need for improved safety while driving cars. Driving safety is ensured by the implementation of advanced technologies, one of which is sensor technology. In order to get an insight into the standard sensors that are implemented in almost every vehicle nowadays, we have provided an illustration in Figure 6.

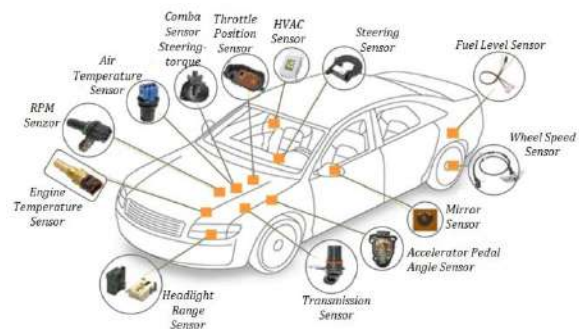

**Fig. 6.** Implementation of basic smart sensors for obtaining status information

Figure 6 shows the following sensors: engine temperature sensor, rpm sensor, air temperature sensor, load sensor, throttle position sensor, rain sensor, steering wheel position sensor, fuel level sensor, wheel speed sensor, mirror sensor, pedal position sensor throttle, vehicle speed sensor and headlight position sensor. The listed sensors provide the driver with information for safe participation of the vehicle in traffic. Ever since the appearance of the first car, there has been development and research in this area, so

that there has been continuous progress in the field of safety and comfort when driving a car. We will list the levels of car automation [15,17] :

- *Level 0:* there is no automation, and the driver controls the vehicle,
- *Level 1:* maintaining the distance between cars is automated, and the driver still controls the vehicle,
- *Level 2:* partial automation, e.g., keeping a lane and keeping a distance between cars; the driver can take over driving the car at any time,
- *Level 3:* when the car is aware of the environment in which it is located and of all traffic participants; it has the possibility to independently pass the car in front of it,
- *Level 4:* when the system controls the car independently, reacts to traffic participants as well as to sudden traffic events; the car informs the driver when he has to take control of the vehicle, and is provided with enough time to take control; this automation is in test stage with maximum speed up to 50 km/h.
- *Level 5:* complete automation when the system controls the car independently and the car can independently go from point A to point B without the presence of a driver and park itself in any environment and conditions.

The development and research of advanced technologies, primarily sensor technology, and its implementation in the automotive industry brings us to level 5, i.e., the autonomous car. The sensor systems that make this possible are shown in Figure 7 [15].

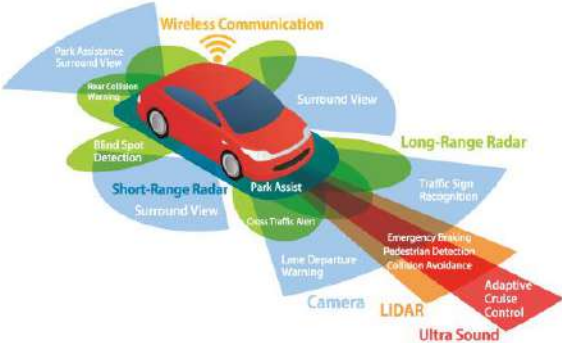

**Fig. 7.** Smart sensor systems implemented in the autonomous car

As we can be seen in Figure 7, many smart sensors and mechatronic systems have been implemented in the autonomous car, with which

it can independently participate in traffic with or without the influence of the driver. The main element of its successful functioning, as a car that is not driven by a human, is for the vehicle to be aware of its surroundings and other traffic users, which is enabled by the aforementioned numerous smart sensors, radars, GPS and communication with smart infrastructure. Modern cars already have partial automation, and the predominance of fully automated cars is expected by 2030.

**4 Research and development in sensor technology**

Continuous research and development of advanced technologies that are implemented in the automotive industry have led to the upgrade of the classic traffic system, which achieves a significant improvement in traffic performance, more efficient transport of passengers and goods, improvement in traffic safety, comfort and protection of passengers, reduction of environmental pollution, etc. The upgrade of the classic traffic system is nothing but intelligent traffic system, which is defined as a holistic, management and information communication (cybernetic) upgrade [16,17].

Intelligent traffic systems enable information transparency, controllability and improved response of the traffic system. In other words, it supports the ability to act adaptively in changing conditions and situations, where it is necessary to collect enough data and process them in real time. The collection of data is provided by palm sensors that are implemented both in cars and devices for traffic regulation and other traffic participants. In order to ensure the intelligent transport of people and goods in the future, research, development and improvement of smart sensors need to be continuously conducted, as shown in Figure 8.

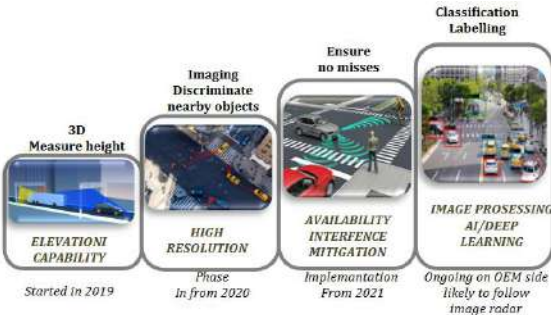

**Fig. 8.** Development of a smart sensor-radar, the future of intelligent traffic

Figure 8 indicates that there are four steps of development of the smart sensor-radar of the future, which started in 2019, and enabled us to measure the height in traffic. Progress in research and implementation of a smart sensor-radar continued in 2021 with a high resolution in which sensors could record and recognize nearby objects [12,13]. In 2021, the improvement of the smart sensor-radar is reflected by reduced interference and increased safety. The improvement is ongoing so that the smart sensor-radar records, classifies and marks traffic participants. The development and implementation of smart sensors in vehicles is constantly increasing, as shown in Figure 9.



Fig. 9. Trend of sensor-camera implementation in vehicles for the period 2012-2024

Based on Figure 9, we can conclude that the implementation of sensor-cameras on vehicles has been increasing on annual basis. In 2012, 2 cameras were implemented in vehicles, while in 2014 this number has increased to 5 sensor-cameras. In 2020, vehicles with 9 implemented sensors-cameras appeared. Sensor-cameras provide information about what is happening in front of the vehicle, behind the vehicle, night vision, driver monitoring, circular view, etc. so that the driver can make decisions in time. The development of sensor technology has led to the point where one smart sensor can be used for more information, i.e., there has been a fusion of smart sensors (Figure 10). For example, in 2020, there has been a fusion of smart ultrasonic sensors used for monitoring the blind spot and parking assistance, or the radar sensors which are used for monitoring the blind spot, parking assistance and maintaining a preset speed and distance from the vehicle in front, as shown in Figure 10. The development in new technologies and sensor technology is expected to increase the fusion of data provided by smart sensors by 2030 [12,13].

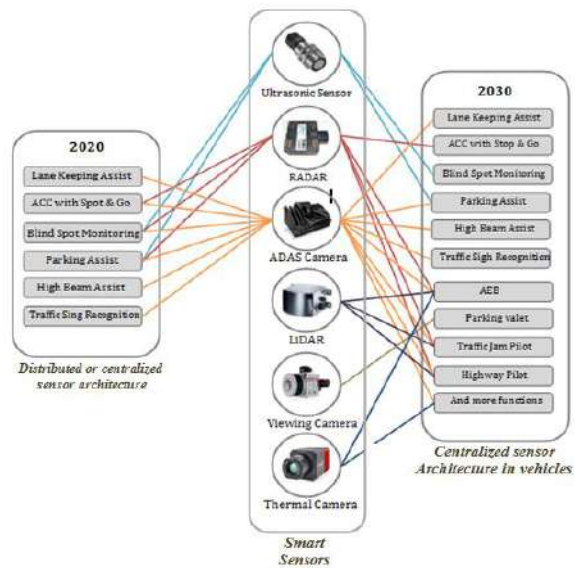

Fig. 10. Trend of smart sensor data fusion in 2020, as well as predictions of data fusion provided by smart sensors until 2030

The data fusion provided by smart sensors is used for automated driving. Each smart sensor used in the vehicle enables greater functionality. New research and development will continue to increase the functionality of each smart sensor for use in the automotive industry as well as other industries. It is expected that a trend in innovations in advanced technologies will increase in the coming years, including sensor technology, as shown in Figure 11 [14,17]. Based on Figure 11, we can see that new innovations are expected from some advanced technologies in 2 years, some technologies in 2-5 years, whereas certain technologies will take 5-10 years and more than 10 years for the development.

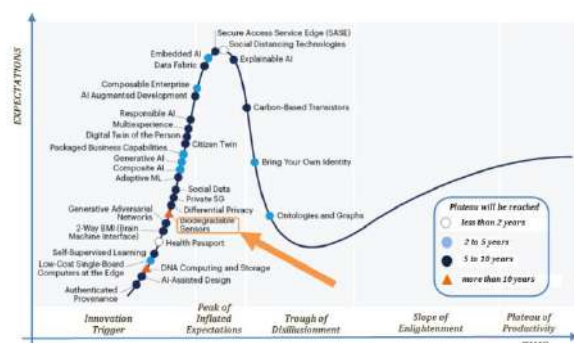

Fig. 11. Expectations of innovation in advanced technologies

Figure 11 lists advanced technologies with certain specified years. It is expected that development and research in sensor technology will lead to biodegradable sensors, and such

research and development requires more than 10 years. It is estimated that the development will lead to a reduction in sensor dimensions and an increase in performance [19,20].

## 5 Conclusion

It is well-known that traffic is continuously increasing, and therefore many problems appear. One of the most important problems that need to be addressed and solved is the issue of traffic accidents. Research and development of advanced technologies used in the automotive industry are directed towards traffic safety, i.e., increasing safety for all traffic participants. Development and research of advanced technologies, including sensor technology, has led to the development of smart sensors that are implemented in cars to facilitate traffic. They also assist the driver to make a timely decision on what to do in order to increase traffic safety and reduce the number of accidents and fatalities of traffic participants. The implementation of sensors in vehicles is continuously increasing on annual basis, so that almost every high-end car has over 100 implemented sensors and over 30 mechatronic systems (electrical/electronic systems) that serve to ensure the safe participation of all traffic users. In the coming years, the trend of innovation in sensor technology will increase, so we can expect a greater fusion in one smart sensor that will be multifunctional. Smart sensors represent the basis for an autonomous vehicle and intelligent traffic systems that will facilitate the movement of goods, people and information in the future. Future research in sensor technology leads to biodegradable smart sensors, which is the goal of reducing pollution in the world.

## References

- [1] Road traffic injuries, [https://www.who.int/health-topics/road-safety#tab=tab\\_1](https://www.who.int/health-topics/road-safety#tab=tab_1) [Accessed: 18.2.2023]
- [2] G.D. Stephane, "Next smart sensors generation", *Conference: Sensors Applications Symposium (SAS), IEEE, 2011*, pp:1-5.
- [3] W. H. Gary, R. S., Joseph, J. H., Peter, & L. Chung-Chiun "Smart Sensor Systems", *The Electrochemical Society Interface*, Winter 2010, 29-34.
- [4] I. Karabegović. E. Karabegović, "Smart Sensors: Support for the Implementation of Industry 4.0 in Production Processes", *Handbook of Research on Integrating Industry 4.0 in Business and Manufacturing, Eds.. Isak karabegović, Ahmed Kovačević, lejla Banjanović-Mehmedović, Predrag Dašić, IGI Global, Hershey PA, 2019, USA* pp.143-163. <https://www.igi-global.com/book/handbook-research-integrating-industry-business/237834> DOI: 10.4018/978-1-7998-2725-2.ch007
- [5] Rockwell Automation, "Smart Sensors, Enabling Smart Machines for The Connected Enterprise", *Publication IOLINK-BR001B-EN-P, 2016, USA*.
- [6] Rockwell Automation, "Sensor Application Guide", *Publication SENS - AT001B-EN-P-May, 2011, 2011, USA*.
- [7] M. Barron, and W. Powers, "The role of electronic controls for future automotive mechatronic systems," *IEEE/ASME Trans. Mechatronics*, vol.1, pp. 80–88, Mar. 1996.
- [8] Vehicle Sensors: Types and Functions, 2020, <https://www.fahadhvassan.com/vehicle-sensors-types-and-functions/>; [Accessed: 24.2.2023]
- [9] How to locate sensors on any car <https://www.youtube.com/watch?v=vJy-wU3d09s>; [Accessed: 12.3.2023]
- [10] High-Performance Magnetic Sensors Speed EV Charging, June 24, 2019 EE Times Staff <https://www.eetimes.eu/high-performance-magnetic-sensors-speed-ev-charging/>; [Accessed: 16.3.2023]
- [11] R. H. Grace, "Automotive Applications of MEMS/MST: The Migration from Discrete Solutions, Advanced Microsystems Automotive Applications" *Proceedings, Berlin, Germany, April 2002, pp 1-14*.
- [12] D.J. Yeong, Velasco-Hernandez, G.; Barry, J.; Walsh, J. Sensor and Sensor Fusion, Technology in Autonomous Vehicles: A Review. *Sensors* 2021, 21, 2140. <https://doi.org/10.3390/s21062140>
- [13] B. Pierrick, Sensor fusion for autonomous vehicles. December 15th, 2020 <https://www.edge-ai-vision.com/wp-content/uploads/2020/12/December-15-2020-Webinar.pdf>
- [14] D. Manian, "Modern Automotive Sensors", New Horizon College of Engineering, Benaguru, 2020, India, pp.1-33 [https://www.academia.edu/43951676/MODERN\\_AUTOMOTIVE\\_SENSORS](https://www.academia.edu/43951676/MODERN_AUTOMOTIVE_SENSORS)
- [15] Self-Driving Car Technology: How Do Self-Driving Cars Work? | Landmark Dividend

<https://www.landmarkdividend.com/self-driving-car/>

- [16] I. Bošnjak, *Inteligentni transportni sustavi 1*. Sveučilište u Zagrebu, Fakultet prometnih znanosti, Zagreb, 2006.pp: 20-34.
- [17] A. Woo, B. Fidan, W.W. Melek, “Localization for Autonomous Driving”, *In Handbook of Position Location: Theory, Practice, and Advances, 2nd ed.*; Zekavat, S., Buehrer, R.M.,Eds.; Wiley-IEEE Press: Hoboken, NJ, USA, 2019; pp. 1051–1087.
- [18]P. S. Lederer, “Sensor” *Handbook for Automatic Test, Monitoring, Diagnostic, and Control Systems Applications to Military Vehicles and Machinery, National Bureau of Standards, Washington, 1981, pp.1-9.*  
<https://nvlpubs.nist.gov/nistpubs/Legacy/SP/nbsspecialpublication615.pdf>
- [19] I. Karabegović, “The Role of Industrial and Service Robots in Fourth Industrial Revolution with Focus on China”, *Journal of Engineering and Architecture, 5(2)*, 2017, pp:110-117.
- [20] S. Andreas, H. Nikolai, & S. Tizian, “Sensors 4.0 – smart sensors and measurement technology enable Industry 4.0”, *Published by Copernicus Publications on behalf of the AMA Association for Sensor Technology, 2018,pp:359-371.*

# PCA modeling of extraction and selection of variables influencing LTE network delay in urban mobility conditions

Mirko Stojčić<sup>1</sup>, Milorad K. Banjanin<sup>2</sup>, Milan Vasiljević<sup>3</sup>, Aleksandar Stjepanović<sup>1</sup>,  
Zoran Čurguz<sup>1</sup>

<sup>1</sup> Faculty of Transport and Traffic Engineering Dobož, University of East Sarajevo, Vojvode Mišića 52, 74000 Dobož, Bosnia and Herzegovina

<sup>2</sup> Faculty of Philosophy Pale, University of East Sarajevo, Alekse Šantića 1, 71420 Pale, Bosnia and Herzegovina; University of Novi Sad, Faculty of Technical Sciences, Trg Dositeja Obradovića 6, 21000 Novi Sad, Serbia

<sup>3</sup> Faculty of Philosophy Pale, University of East Sarajevo, Alekse Šantića 1, 71420 Pale, Bosnia and Herzegovina

## Abstract

In addition to network throughput, which defines the number of bits per second that can be transmitted, another primary measure of network performance is latency, or delay, which defines the time spent sending one bit from one computer to another in the network. In this paper, the main goal of the research is to model the efficient management of delay performance in a 4G Long Term Evolution (LTE) network on a defined section of the trunk road with the assumption that key performance indicators (KPI) can be effectively analyzed with the created predictive classification models. These models also enable the assessment and prediction of the fulfillment of sustainable urban mobility plans. Using Principal Component Analysis (PCA), the space of 17 input variables is reduced to four extracted components. Several models based on different machine learning techniques are created using the automatic modeling method, and the final solution is selected according to the criterion of maximum classification accuracy, interpretability, and complexity. A classification model based on Logistic Regression was chosen as the final solution.

**Keywords:** Predictive classification models, PCA, network delay, LTE network, KPI, urban mobility

## 1 Introduction

The trend of constant growth in demand for various 4G, and today also 5G and 6G services, obliges telecommunication providers to carefully plan and predict the required level of Quality of Service (QoS) to meet user needs in the future [1]. This problem is largely solved by continuously finding ways to efficiently share network radio resources with scheduling algorithms to meet different QoS profiles. The two basic Key Performance Indicators (KPIs) for Real-Time (RT) services, which today make up an increasing part of the total traffic generated in the network, are throughput and delay [1]. End-to-end delay or, in general, delay, can be defined as the time required for a data packet to be transmitted through the network from the source node to the

destination node. It can be represented mathematically by the sum of transmission delay, signal propagation delay, and packet queuing delay. Therefore, the delay depends on many influential factors such as the path length from the source to the destination, intermediate hops in the network, interference, protocols, signal strength, medium properties, medium access control, etc. [2]. The precise formulation of a mathematical model for packet delay prediction is therefore very difficult. In recent years, the solution has been found in the methods and techniques of machine learning, i.e., in Data-Driven models. Contemporary trends are directed towards the creation and prioritization of interpretable models, ahead of complex models that, as a rule, provide better performance. Excessive network delay can significantly negatively affect the

---

Corresponding author: *Mirko Stojčić* ([mirko.stojcic@sf.ues.rs.ba](mailto:mirko.stojcic@sf.ues.rs.ba))

© 2023 The Author(s). This work is licensed under a Creative Commons Attribution 4.0 International License.

Quality of Experience (QoE) of users of telecommunication services, especially in conditions of high mobility in cities [2, 3]. This influence is expressed by measures of rigidity that services cause in users: Interpersonal (R1), Behavioral (R2), Structural - longing for structure and coping with the lack of structure (R3), Prospective anxiety (R4), Inhibitory rigidity (R5) [2, 3].

Modern, and especially mobile networks of the next generation, are characterized by a very large amount and variety of network variables - KPI. They significantly complicate the process of their predictive modeling. In the current research, an efficient selection of a smaller set of KPIs, i.e. their influencing factors, using Dimensionality Reduction techniques is proposed as a solution, which includes two approaches: Feature Selection and Feature Extraction [4]. Compared to Feature Selection, Feature Extraction techniques can retain a larger amount of information from the initial, complete data set. In modeling network performance, two families of Feature Extraction techniques are of particular importance:

- 1) Component Analysis, the most popular of which are Principal Component Analysis (PCA), kernel PCA (kPCA), and Independent Component Analysis (ICA);
- 2) Manifold Learning, of which the most commonly used are Locally-linear embedding (LLE) and Spectral embedding (SE) [4].

Today, mobile users and providers are witnessing the growing use of multimedia real-time applications. This is of particular importance for researchers, especially in urban areas characterized by high density of users and high mobility of users. In such circumstances, network delay is a decisive factor for a satisfactory level of QoE and QoS. Therefore, the main purpose and reason of this research is to contribute to the predictive modeling of delay in urban mobility conditions. The research is aimed at end-to-end delay (as a dependent variable) in the 4G LTE network in the area of the section of the M17 trunk road in Republic of Srpska, Bosnia and Herzegovina. The task is to create a machine learning model that, based on given input variables, can classify the delay. In this paper, delay is represented by a discrete scale with three levels. The created models must have sufficiently high accuracy. To reduce the dimensionality of the space of input variables, PCA is applied over the original set of 17 research variables as one of

the most common linear feature extraction techniques. In the final step, a comparison of the classification results is made for the complete set and the set of extracted input variables. Based on that, the final solution is chosen with the assumption that the created models can be universally used for all Real-Time services.

Predictive delay modeling is the subject of numerous published studies. Papers [2], and [5] – [10] explore models based on different machine learning techniques, in different network environments and in combination with other approaches. A more detailed analysis of these studies is given in Section 2.

The research on network delay in this paper is of great importance from the aspect of sustainable urban mobility. In addition to the observed section being part of one of the most frequent road routes in Republic of Srpska and Bosnia and Herzegovina, urban and suburban transport of a large number of passengers takes place along it. At the same time, it is considered that passengers are also users of various telecommunication services, most of which are very sensitive to delays. In such circumstances, predictive delay models can be used to predict and assess the degree of fulfillment of the Sustainable Urban Mobility Plans (SUMP) in the domain of quality of the urban environment and quality of life.

As the main contributions presented in this paper, the following can be singled out:

- To the best of our knowledge this is the first research related to the modeling of delays in the LTE network in the observed area of the road section in the context of urban mobility;
- Several machine learning models were trained and tested and the best one was selected from among them;
- Created classification models have an overall accuracy of over 90% with a PCA reduced set of input variables;
- The selection of the final model, apart from classification performance, was made according to the criteria of interpretability and complexity;
- The observed traffic section geographically extends approximately parallel to and near the section of the pan-European corridor Vc. It gives additional importance and weight to this research because the results are applicable in that area as well;
- The results presented in this research can be of practical importance when designing or

expanding the network in the observed geographic area.

The structure of the paper consists of five sections. After the introductory part, the second section provides an overview of relevant published research. The third section describes the steps of the methodological research procedure, as well as the materials used. The main focus is on the fourth section, where the results of the research and discussion are presented. Concluding considerations are given in the last, fifth section. At the end of the paper is a list of used references.

## 2 Review of Relevant Published Research

To date, more research has been published related to predictive modeling of delays in 4G LTE networks. In paper [2], the goal is to evaluate the applicability and ability of an artificial neural network for end-to-end packet delay prediction in a mobile ad-hoc network environment. As input variables, the authors use the length of the path and the average number of hops between the source and the destination. Round-trip time (RTT) delay is the subject of research in [5]. The problem being solved is the prediction of changes in the value of this variable in mobile broadband networks. Four classification models based on machine learning were created in the paper, and the binary ensemble model showed the best performance. In the paper [6], the authors present an approach based on machine learning, which, thanks to data from real mobile networks, performs delay prediction. A large data set with more than 238 million delay measurements for three different commercial mobile operators is considered. A delay prediction framework that integrates machine learning and statistical approaches is defined in [7]. The first created model is based on Long Short-Term Memory (LSTM), and the second is based on a combination of Epanechnikov Kernel and moving average function. In paper [8], a low-complexity algorithm for predictive resource allocation for delay-sensitive Machine to Machine (M2M) services in the LTE uplink direction is specified. One of the key issues in 4G networks is how to efficiently use radio resources. The proposal of the new LTE packet scheduler mechanism and Packet Prediction Mechanism (PPM) was given by the author's team in the research [9]. Paper [10] deals with the topic related to the Industrial Internet of Things (IIoT), in which predictive

delay models are created to evaluate network performance.

## 3 Materials and Methods

The methodological procedure of the research in this paper consists of several successive steps and is shown graphically in Fig. 1. The first step refers to data collection. In the second step, PCA was applied over the defined set of input variables, which extracted the main components that have the function of input into predictive models. Training and testing of classification models in the IBM SPSS Modeler software environment are performed in the fourth step. Based on the results obtained, the final model is then selected according to the criteria of overall classification accuracy, complexity, and interpretability.

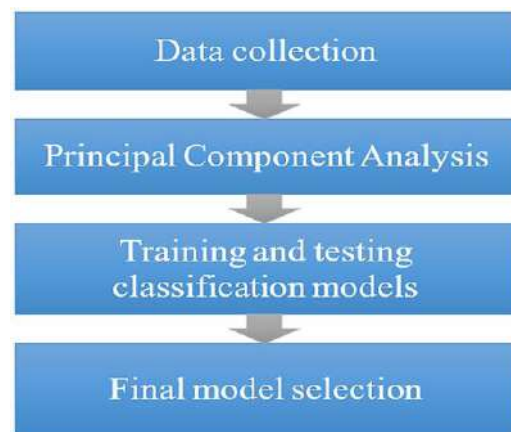

Fig. 1. Methodological procedure of research

### 3.1 Data Collection

The research is geographically oriented to the area of the section of the M17 main road between the city of Doboј and the Johovac node at the junction of the "9.januar" motorway. This 10 km long section is marked in blue in Fig. 2.

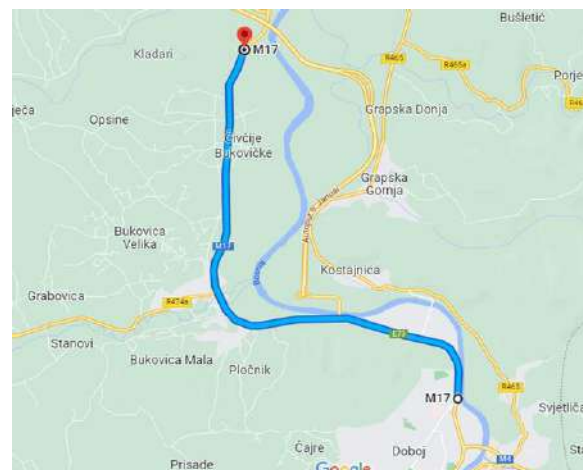

Fig. 2. Geographical area of research [11]



The set of research data was obtained from the mobile operator M:tel Banja Luka based on an officially sent Request (under an official cooperation agreement) which specified the necessary variables [12]. From the obtained database for the 4G LTE network, for the purposes of this research, a total of 1077 values of research variables were extracted for the period between 01.01.2021. and 15.01.2021. with a one-hour sampling frequency [12]. The data are structured into (input/output) vectors. The values of the 17 independent variables given in Table 1 represent the input part, and the value of the dependent variable-delay, the output part of the vector.

Since they are not given in the M:tel database, the continuous delay values are obtained indirectly based on the research presented in [13]. First, the Real Time Video delay value is estimated depending on the number of active users for the exponential rule (EXPRULE) scheduling algorithm (from Figure 6(a) in [13]). As a result of the regression over the estimated values, a cubic function is obtained:

$$y = 8 \cdot 10^{-8}x^3 - 2 \cdot 10^{-5}x^2 + 0.0022x - 0.0063 \quad (1)$$

where  $y$  is the delay and  $x$  is the average number of users in the cell. This function has a very high coefficient of determination  $R^2=0.9914$  and is shown graphically in Fig. 3.

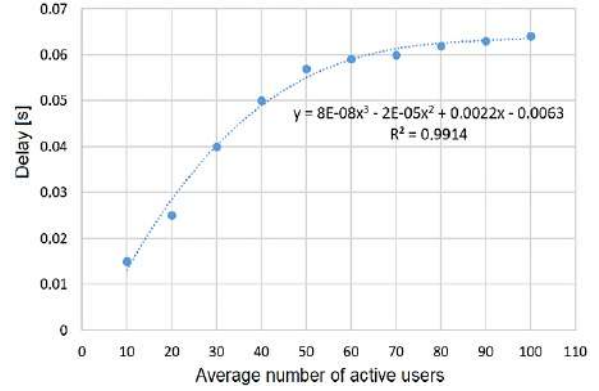

**Fig. 3.** Approximate cubic delay function

Based on Eq. (1) and the known (from the M:tel database) average number of active users in the cells, delay values were calculated. Classification implies the discrete nature of the dependent variable. Therefore, the values thus obtained were mapped into a discrete scale with three classes according to Packet Delay Budget requirements for individual services [14], which is shown in Table 2.

**Table 2.** Mapping delay values to classes

Packet Delay Budget	The interval of continuous delay values	Discrete value-class
Real Time Gaming: 50 ms	$\leq 50$ ms	1
Conversational Voice: 100 ms	From 50.01 ms to 100 ms	2
Conversational Video-Live Streaming: 150 ms	From 100.01 ms to 150 ms	3

**Table 1.** Independent/input research variables

Variable label	Meaning
DPUR	Downlink (DL) Physical Resource Block (PRB) Usage rate [%]
ACQI	Average Channel Quality Indicator (CQI)
RRCAtt	Number of attempts by the User Equipment to establish a connection with an eNodeB
CellADT	Cell average DL throughput [kbit/s]
UserADT	User average DL throughput [Mbit/s]
URTR	Uplink (UL) retransmission rate [%]
DRTR	DL retransmission rate [%]
DIBLER	DL Initial Block Error Rate (IBLER) [%]
UIBLER	UL IBLER [%]
CellITVD	Total aggregated DL traffic in the cell [Gbit]
CellITVU	Total aggregated UL traffic in the cell [Gbit]
CellAUT	Cell average UL throughput [kbit/s]
UserAUT	User average UL throughput [Mbit/s]
AUInt	Average UL interference [dBm]
DSCH16QAM_RET	Number of retransmitted TB into DL shared transport channel under 16QAM
DSCH64QAM_RET	Number of retransmitted TB into DL shared transport channel under 64QAM
DSCHQPSK_RET	Number of retransmitted TB into DL shared transport channel under QPSK

### 3.2 Principal Component Analysis

PCA is one of the most popular techniques used to reduce the dimensionality of large datasets by linear transformations of variables into a smaller one. They retain most of the information, i.e. the variability of the original set. Thus, the goal is to find or extract new variables - principal components (PCs). They are linear functions of those in the original data set, they are not correlated with each other, and they successively maximize the variance. This comes down to the eigenvalue/eigenvector problem [15]. In this paper, the PCA procedure on 17 input variables is performed in the IBM SPSS Statistics software environment. The main reasons for applying PCA to such a set of variables are as follows: PCA can prevent overfitting; Correlated variables are removed; Machine learning algorithms converge faster; Easy visualization.

### 3.3 Training and Testing Classification Models

The classification problem in machine learning is solved according to the supervised learning paradigm. The entire set of research data in this paper is divided into two parts: training data and testing data in a ratio of 70:30. This ratio of division was chosen considering that it is one of the most common in research. Structured input-output vectors are processed in the IBM SPSS Modeler software using the Auto Classifier node to automatically create different delay classification models simultaneously. In one pass through the modeling process, Auto Classifier examines different machine learning techniques, with default option settings [3]. In this case, options mean e.g. the number of layers of the neural network, the number of neurons in each of them, the shape and parameters of the classification function, the training algorithm, the stopping criteria, the size of the tree, etc. Supported techniques include neural networks, classification and regression trees (C&R Tree), Quick, Unbiased, Efficient Statistical Tree (QUEST), Chi-square Automatic Interaction Detection (CHAID), C5.0, Logistic regression, decision list, Bayesian networks, Discriminants, Nearest neighbors and Support Vector Machines (SVM). Based on the results of model testing, Auto Classifier offers the most accurate solutions and ranks them according to the overall classification accuracy expressed as a percentage [3].

### 3.4 Final Model Selection

In addition to the overall accuracy of vector classification, as one of the key indicators of predictive performance, special attention should be paid to its complexity and interpretability when choosing the final model. In general, models with more complex machine learning algorithms are more difficult to interpret. The reason for the complexity of the model, apart from the algorithms, can be the dimensionality of the space of input variables. At the same time, complexity can also be increased by the functions that models need to learn. Although complex predictive models usually provide the best performance, numerous studies give priority to simpler, more interpretable solutions [16,17,18]. Although a formal, mathematical definition of interpretability is lacking in machine learning, the paper [17] lists several definitions of this term. Among them the following stands out as frequently used: "interpretability in machine learning is the degree to which a human can understand the cause of the machine learning model's decision". In recent years, a relatively new field called Interpretable Machine Learning (IML) has emerged, owing to this reason. Methods for transforming black-box machine learning models into white-box are researched in this area [17,19].

In this paper, in addition to the models created over the extracted PC as input variables, classification models are also created over the entire set of 17 variables using the automatic modeling method. In the last step, the prediction performance, complexity, and interpretability of the created models are compared, and the final model is selected based on the previously explained.

## 4 Results and Discussion

In accordance with the objective and methodology of the research, after collecting the data, it is necessary to reduce the dimensionality of the input space of the machine learning models. Optimization of the number of input variables is achieved by applying PCA over the original set of 17 input variables. As the first result of the PCA, Table 3 shows the value of the Kaiser-Meyer-Olkin (KMO) coefficient and the Bartlett's Test of Sphericity statistics. The sample size is considered adequate if the KMO coefficient is greater than 0.5. In this case, based on the value of  $KMO=0.795$ , the same conclusion is drawn: a sample of 1077 input/output vectors is adequate

for PCA application. Bartlett's Test of Sphericity is an indicator of the strength of the relationship between variables. It tests the null hypothesis, which represents the assumption that the correlation matrix is, in fact, an identity matrix in which the diagonal elements are equal to 1, and all others are equal to 0. This test is usually performed before the actual application of one of the data dimensionality reduction techniques. The aim is to confirm statistically that the observed technique can "compress" the data in a meaningful way. It can be seen from Table 3 that the calculated value of the statistic Sig.=0.000 is less than the conventional level of significance  $\alpha=0.05$ , based on which it is concluded that the null hypothesis is rejected.

**Table 3.** KMO and Bartlett's Test of Sphericity

Kaiser-Meyer-Olkin Measure of Sampling Adequacy		0.795
Bartlett's Test of Sphericity	Approx. Chi-Square	27119.791
	df	136
	Sig.	0.000

Fig. 4 shows the values of the standardized data variance (eigenvalue) associated with each extracted component from the initial solution. The most common criterion for choosing the optimal (reduced) set of components is the condition: eigenvalue > 1. This means that based on the results given in Fig. 4, it is necessary to take into account the first four significant components (factors) that will represent the entire set of 17 input variables.

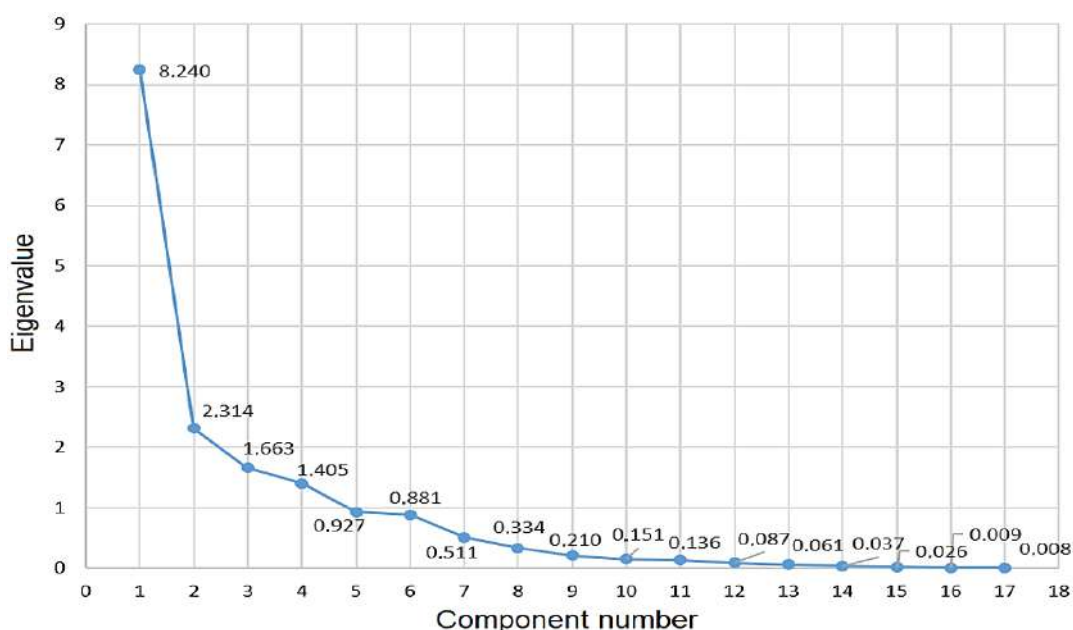

**Fig. 4.** Values of standardized variance (eigenvalues) associated with individual components

Table 4 shows the eigenvalues for the first four components by percentage participation in the total variance of the data. It can be seen that the first component explains 48.47%, the second 13.612%, the third 9.78%, and the fourth component 8.266%. Cumulative, four-component solution explains a total of 80.128% of the data variance.

**Table 4.** Total variance explained by the four-component solution

Component	Initial Eigenvalues		
	Total	% of Variance	Cumulative %
1	8.240	48.470	48.470
2	2.314	13.612	62.082
3	1.663	9.780	71.862
4	1.405	8.266	80.128

To increase the interpretability of the solution, the components are rotated, and in this case, as most often, an orthogonal Varimax rotation was performed. In addition, Kaiser normalization increased the stability of the solution in the sample. Table 5 shows a rotated matrix of components. The connection of each variable with the component is represented by a weighting factor that can have a value in the interval between -1 and 1. Loading factors less than 0.30 are not shown in the table. Based on these coefficients, a conclusion can be drawn about the method of "grouping" the variables into individual components. This represents the most important result of PCA.

**Table 5.** Rotated component matrix

Input/Independent variable	Component			
	C1	C2	C3	C4
DPUR	0.956			
DSCH16QAM_RET	0.926			
CellTVD	0.911			
DSCH64QAM_RET	0.837	0.325		0.340
UserADT	-0.800			0.444
DSCHQPSK_RET	0.742		0.413	
CellTVU	0.737	0.561		
RRCAtt	0.597		0.365	0.487
DIBLER	0.580		0.576	
UserAUT		0.843		
CellAUT	0.404	0.834		
AUInt		0.453		
DRTR			0.837	
URTR		0.385	0.729	
UIBLER	0.410	0.474	0.641	
ACQI				0.865
CellADT				0.820

The presented PCA results indicate that it is possible to consider the four extracted components C1, C2, C3, and C4 as inputs to predictive models. They retain information from the original set of input variables to a certain extent. In the IBM SPSS Modeler software environment, data is processed using the Auto Classifier option, to automatically train and test different classification models. The performance for the three best solutions is presented graphically in Fig. 5. It is concluded that Logistic regression with a total classification accuracy of 92.13% is the most accurate model created over the input set of four components obtained by extraction.

Predictive models were also created over the complete set of 17 inputs. Fig. 5 shows that in this case the Neural network model has the highest percentage of correctly classified vectors of 96.759%. The difference between these two models is 4.629% more correctly classified data in favor of the model with 17 input variables. However, due to the many times smaller number of inputs (4.25 times) and easier interpretability, the first model based on the Logistic regression technique is chosen as the final solution. One of the basic goals of the paper was fulfilled in this way because it can be considered that the final model has sufficiently high accuracy. In both cases, the C5.0 model is shown to have the lowest classification performance values.

Logistic regression, as the finally selected model, makes predictions by creating the following set of equations that connect the values of the input fields with the probabilities of association or belonging to each category-class of the output variable:

$$Y_{Class1} = 0 \text{ (the reference class),} \quad (2)$$

$$Y_{Class2} = 4.069 + 4.138 \cdot C1 + 2.273 \cdot C2 + 1.524 \cdot C3 + 1.265 \cdot C4 \quad (3)$$

$$Y_{Class3} = -8.972 + 8.715 \cdot C1 + 4.546 \cdot C2 + 3.793 \cdot C3 + 3.845 \cdot C4 \quad (4)$$

where  $Y_{Class1}$ ,  $Y_{Class2}$  and  $Y_{Class3}$  are the class labels of the output variable. Once a model is generated in this way, it is easily used to estimate class membership for new input data. For the values of the independent variables, the probability of belonging to each class is calculated according to the previously mentioned formulas, and the class with the highest probability is assigned as the final value.

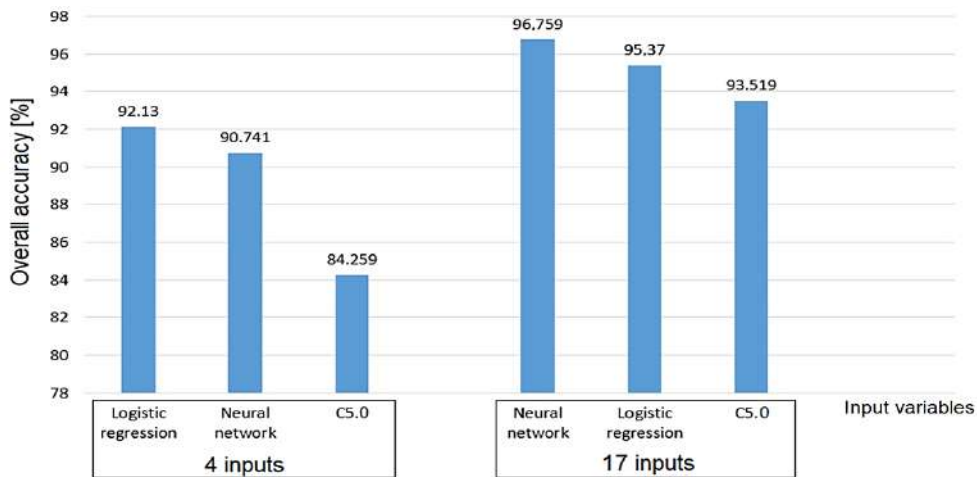

**Fig. 5.** Classification accuracy values for models created over 4 and over 17 input variables

## 5 Conclusion

In the paper, the basic objectives of the research that were set were fully achieved. Predictive models were created for the classification of end-to-end delay for real time services in the 4G LTE network. The complete available set of 17 input variables was reduced to four PCA extracted variables. The machine learning model was trained and tested by the supervised learning paradigm on the complete available set of inputs, as well as on the extracted components. In the last step, based on the defined methodology and research objectives, the final model was chosen according to the criteria of overall accuracy, complexity and interpretability. For the full set of input variables, the best prediction performance was shown by the neural network model with 96.758% correctly classified vectors from the test set. The results of testing the classification models for four inputs showed a slightly lower percentage of classification accuracy. As the best model, in this approach, Logistic Regression has a classification accuracy of 92.13%. These model performances in both cases, according to the research objectives, are considered sufficiently high and acceptable. When choosing the final solution, in addition to the specified classification accuracy, the complexity and interpretability of the model was taken into account. In this paper, the Logistic Regression model with four inputs was chosen as the final model because it is less complex and more interpretable than the neural network model. The feature extraction technique for reducing the dimensionality of the space of input variables has shown its effectiveness. In addition to interpretability, the final model retained a large percentage of the information from the initial data set. The four extracted components explain a total of 80.128% of the data variance. These components indirectly through delay and measures of rigidity R1, R2, R3, R4 and R5 affect QoE and sustainable urban mobility. Delay as an important indicator of network performance is related to and to a certain extent affects SUMP performance such as quality of life, urban environment, effective use of limited resources, etc. Therefore, knowing the value of the delay in the future using predictive models also means knowing the degree of SUMP fulfillment in a certain segment. Greater accuracy of delay classification provides greater accuracy of SUMP fulfillment degree prediction. Future research directions can be oriented towards the application

of other individual Feature Extraction techniques, and the comparison of the obtained results.

## References

- [1] N. K. Madi, & M. Madi, "Analysis of downlink scheduling to bridge between delay and throughput in LTE networks", In *2020 7th international conference on electrical and electronics engineering (ICEEE)*, IEEE, April 2020 (pp. 243-247).
- [2] J. P. Singh, P. Dutta & A. Pal, "Delay prediction in mobile ad hoc network using artificial neural network", *Procedia Technology*, 4, 201-206, 2012, <https://doi.org/10.1016/j.protcy.2012.05.030>
- [3] M. K. Banjanin, M. Stojčić, D. Danilović, Z. Čurguz, M. Vasiljević, & G. Puzić, "Classification and Prediction of Sustainable Quality of Experience of Telecommunication Service Users Using Machine Learning Models", *Sustainability*, 14(24), 2022, 17053.
- [4] I. de-la-Bandera, D. Palacios, J. Mendoza & R. Barco, "Feature extraction for dimensionality reduction in cellular networks performance analysis", *Sensors*, 20 (23), 6944, 2020. <https://doi.org/10.3390/s20236944>
- [5] A. H. Ahmed, S. Hicks, M. A. Riegler & A. Elmokashfi, "Predicting High Delays in Mobile Broadband Networks", *IEEE Access*, 9, 168999-169013, 2021.
- [6] A. S. Khatouni, F. Soro & D. Giordano, "A machine learning application for latency prediction in operational 4g networks", In *2019 IFIP/IEEE Symposium on Integrated Network and Service Management (IM)*, April 2019, (pp. 71-74). IEEE.
- [7] W. Zhang, M. Feng, M. Krunz & H. Volos, "Latency prediction for delay-sensitive v2x applications in mobile cloud/edge computing systems", In *GLOBECOM 2020-2020 IEEE Global Communications Conference*, IEEE, December 2020, (pp. 1-6).
- [8] J. Brown & J. Y. Khan, "A predictive resource allocation algorithm in the LTE uplink for event based M2M applications", *IEEE Transactions on Mobile Computing*, 14(12), 2015, 2433-2446.
- [9] W. K. Lai, C. W. Hsu, T. H. Kuo & M. T. Lin, "A LTE downlink scheduling mechanism with the prediction of packet delay", In *2015 Seventh International*

- Conference on Ubiquitous and Future Networks* IEEE, 2015, July (pp. 257-262).
- [10] R. Zhohov, D. Minovski, P. Johansson & K. Andersson, “Real-time performance evaluation of LTE for IIoT”, *In 2018 IEEE 43rd Conference on Local Computer Networks (LCN)*, 2018, October (pp. 623-631), IEEE.
- [11] <https://www.google.com/maps/dir/44.7438539,18.0953169/44.8027333,18.048289/@44.782805,18.0279954,12.26z/data=!4m2!4m1!3e0>
- [12] M. K. Banjanin, M. Stojčić, D. Drajić, Z. Čurguz, Z. Milanović, & A. Stjepanović, A., “Adaptive Modeling of Prediction of Telecommunications Network Throughput Performances in the Domain of Motorway Coverage”, *Applied Sciences*, 11(8), 3559, 2021. <https://doi.org/10.3390/app11083559>
- [13] J. I. A. Y. Yaqoob, W. L. Pang, S. K. Wong, & K. Y. Chan, “Enhanced exponential rule scheduling algorithm for real-time traffic in LTE network”, *International Journal of Electrical and Computer Engineering (IJECE)*, 10(2), 2020, 1993-2002.
- [14] ETSI TS 123 203 V9.7.0 (2011-01), “Technical Specification Digital cellular telecommunications system (Phase 2+); Universal Mobile Telecommunications System (UMTS); LTE; Policy and charging control architecture (3GPP TS 23.203 version 9.7.0 Release 9)“ [https://www.etsi.org/deliver/etsi\\_ts/123200\\_123299/123203/09.07.00\\_60/ts\\_123203v090700p.pdf](https://www.etsi.org/deliver/etsi_ts/123200_123299/123203/09.07.00_60/ts_123203v090700p.pdf)
- [15] I. T. Jolliffe & J. Cadima, “Principal component analysis: a review and recent developments“, *Philosophical transactions of the royal society A: Mathematical, Physical and Engineering Sciences*, 374(2065), 2016, 20150202.
- [16] M. A. Ahmad, C. Eckert, A. Teredesai, “Interpretable machine learning in healthcare“, *In Proceedings of the 2018 ACM International Conference on Bioinformatics, Computational Biology, and Health Informatics*, Washington, DC, USA, 29 August–1 September 2018, pp. 559–560.
- [17] T. A. Abdullah, M. S. M. Zahid & W. Ali, “A review of interpretable ML in healthcare: taxonomy, applications, challenges, and future directions“. *Symmetry*, 13(12), 2021, 2439.
- [18] B. Dherin, M. Munn, M. Rosca & D. Barrett, “Why neural networks find simple solutions: the many regularizers of geometric complexity“, *Advances in Neural Information Processing Systems*, 35, 2022, 2333-2349.
- [19] G. Stiglic, P. Kocbek, N. Fijacko, M. Zitnik, K. Verbert, L. Cilar, “Interpretability of machine learning-based prediction models in healthcare“, *Wiley Interdiscip.-Rev.-Data Min. Knowl. Discov.*, 2020, 10, e1379. doi:10.1002/widm.1379.

# Data architecture proposal of big data platform for smart waste management solution

Sanid Muhić<sup>1</sup>, Nermin Goran<sup>1</sup>

<sup>1</sup> University of Sarajevo, Faculty of Traffic and Communications, Zmaja od Bosne 8, Sarajevo 71000, Bosnia and Herzegovina

## Abstract

The aim of the work is to present the data architecture proposal for use of big data technologies to create a business platform that will enable a autonomy of business processes and near-real time reaction to changes in the internal and external environment of the smart waste management system. A brief overview of the relevant literature shows that the work was mainly done on individual components and use cases dealing with mainly individual business process. This proposal emphasizes the need for a systemic and broader view of the overall processes and the need for the existence of a platform that will enable the use of different technological solutions for individual components of the business subsystem. Proposed model describes the components specific to the waste management system. Special details are devoted to the elements crucial to establishing smart management using AI and ML processes. The paper will highlight the potential advantages and opportunities that the proposed architecture should enable and improve the existing vision and solutions of smart waste management. The components are described in a graphic representation of the entire system architecture, which in future iterations should be further refined in more detail for the specific needs of the smart waste management system for real business needs. The purpose of the proposed architecture is to optimize the process of waste transportation as one of the key processes of urban mobility in cities using Big Data, AI and ML technologies.

**Keywords:** Big Data architecture, Waste management, Kafka, Streams, Batch processing, IoT, AI, ML

## 1 Introduction

Waste management as a social process in society does not receive as much attention as commercial projects, especially when we talk about complete big data solutions and their realization in the real sector.

Sustainable development programs offer the possibility of financing project for these solutions, but also taking into account the commercial solutions so far, there is not a single example of a functional and comprehensive big data platform for the need of waste management.

Big data concept, by using high technology, enables much greater possibilities than 10 years ago, when it first appeared. This also brings

certain challenges, especially when it comes to the possibility of collecting a large amount of data and then the comprehensive complexity and efficiency of the system for processing and making useful conclusions from a business perspective.

The purpose of proposed architecture is to define big data platform components for optimal relationship between business needs and technological capabilities, with the aim of creating the most efficient data collection model including the business aspect of waste management.

In the previous works, individual elements of the business process of waste management were mostly processed, while not going into the general

---

Corresponding author: Sanid Muhić (sanid.muhic@gmail.com)

© 2023 The Author(s). This work is licensed under a Creative Commons Attribution 4.0 International License.

systemic aspect. Most papers are just about systems that collect data on the amount of generated waste in real time or the possibilities of using deep learning algorithms for waste classification, but no one considers business requirements.

## 2 Related works

Existing and available literature mainly contains examples of different models and frameworks for smart waste management. Most of the presented solutions include partial solutions to problems or the use of technologies for certain aspects and individual components of the waste management subsystem.

In the analyzed papers, the authors proposed models that deal with solutions to problems that include:

- identification of waste containers,
- identification of the filling level of waste containers,
- routing of vehicles for waste removal, in accordance with the capacity of waste containers,
- using artificial intelligence for waste classification

Analyzing the literature, the solutions mostly solved the problems identically, but with the use of different technologies. The earliest solutions used only RFID technologies, and after that came models of solutions with IoT sensors and communication technologies based on cellular networks or, in recent literature, Lora WAN technologies. [1-8]

Paper [1] defines architecture of Waste City Management System solution for a waste management system based on IoT sensor technologies, and also discusses a algorithm for optimizing transportation routes by dividing them into clusters.

An IoT based application, with advanced system of IoT devices that uses an ultrasonic sensor to collect the volume of waste containers, but also detects the arrival of the client, and automatically opens lid of the bin can be used as part of smart garbage management system for a sustainable urban life [2].

The paper [3] proposed and analyzed the use of a specific algorithm for routing garbage

collection vehicles combining graph theory and logistic regression, with the possibility of assessing the probability of a trash bin being fully based on the number of classes in the university.

Artificial intelligence is most often used for waste classification using deep learning algorithms. Use of CNN image recognition networks (Convolution Neural Network) is one of solutions for waste classification [4].

Paper [5] explains the use of the VGG16, a deep learning-based classification mechanism, to identify the waste and proposes a waste separation system using a robotic arm.

Some models deal with special classes of waste, such as food or construction material. The proposed solutions extend the systems to details related to identification for billing purposes or provide a detailed model for each special administrative business service domain [6].

All proposed solutions do not observe, in depth, the business aspect of processes in terms of parameters that should be taken as relevant for analysis, e.g. For efficient routing of waste collection vehicles, it is not only the volume - percentage filling of waste bins that is relevant, but also the weight of the waste as well as the current capacity of the vehicle that collects the waste. Most of the solutions take a constant limit for deciding on the need to empty the corresponding container, eq. 70% [7], although for the business approach more relevant data are on the dynamics, i.e. the speed of filling the waste container.

In the paper, we will propose a data platform that should integrate and unify the use of several proposed solutions in terms of architecture that would support the application of some of the proposed solutions, but also their upgrading and the use of input in ML and AI processes with the aim of learning a better model that is more relevant for the decision making. The solution should support near-real time processes as well as batch processing for business intelligence.

## 3 Data architecture proposal of big data platform for smart waste management

The basic task of the proposed data architecture is scalability and the possibility to satisfy the needs for infrastructure that would enable different cases of using big data



technology for the needs of smart waste management system.

Scalability includes the collection, processing and use of processed data results in the case of batch, i.e. post-processing of data for the purpose of business intelligence, but also for different ML and AI models, as well as use for near-real time processing of data for navigation and timely transfer of information between clients, management and workers who collect waste.

The architecture differs from the classic so-called Lambda architecture, which implies the existence of two different data layers, one for batch processing and the other for real time processing.

The architecture of the proposed system relies on the use of Kafka, as the main and basic protocol for collecting and "pre-processing" data, based on which part of the data, through the application of the API, would be used for real-time response needs. The second part of the data would feed the HADOOP data plane for BI/AI processes.

The described frame is represented by Figure 1, and below are the descriptions of components specific to the waste management system.

**IoT sensors** specific to waste management can be diverse.

**Ultrasonic sensors** for evaluating container capacity. Containers for collected waste can be of different dimensions and sizes, and can be installed independently or underground. The system must be suitable for the possibility of processing sensors from different manufacturers and different data transfer technologies, as well as the possibility of processing data in the case of the existence of two or more sensors on one container for the purpose of better prediction of capacity.

**IoT sensors for detecting bad smells, gases, as well as temperature and humidity** can be included in the process of prioritizing a certain container in case of incidents related to endangering human health.

The system should also have the possibility of using IoT sensor scales on containers or trucks, and efficient recording of weight changes of the material being transported.

**Container identification devices**, which are emptied, can include **RFID** sensors on trucks and RFID identification on containers or the use of

**cameras** with an **OCR** system to read the identification.

The **GPS** system for tracking the path of waste removal trucks is one of the main elements that enables the collection of necessary information about the location, path and the time of unloading, i.e., the retention of vehicles at individual waste removal clusters.

**Fuel and its consumption** is one of the key costs of the waste transportation system. It is possible to monitor fuel consumption through **Smart OBD sensor devices** that communicate with the truck's main computer and provide a prediction of fuel consumption. A more efficient and accurate way of collecting data on fuel consumption is a **fuel pump station** with the possibility of logging the amount of truck filling using identification cards. The proposed data architecture should enable an efficient system of pumping data from the pump station logs, and their efficient processing in near-real time with the possibility of calculating data on the average fuel consumption for a given route.

Key data for managing waste removal must also include **large scales** that will enable the application of an efficient and controlled waste transshipment process, before transport, to the final location of the landfill.

The most important business data about customers, their locations, available labor and work resources are usually located in one or more **ERP systems**. The proposed architecture must provide a possible way of connection with existing databases as well as an efficient process of non-real time processed data and conversion into useful information.

The system of communication with users as well as the system of active monitoring of work orders are key to the effective reaction of the waste management system with the environment. It is necessary to provide quality tools and a system, which will include the use of various managerial **web dashboards and other web applications**, as well as **mobile applications** for clients and the company's workforce.

**The active system for monitoring work orders** consists of a **web application** for accepting and processing orders and sending effective orders and changing the status of containers in the system that need to be emptied in terms of prioritization.

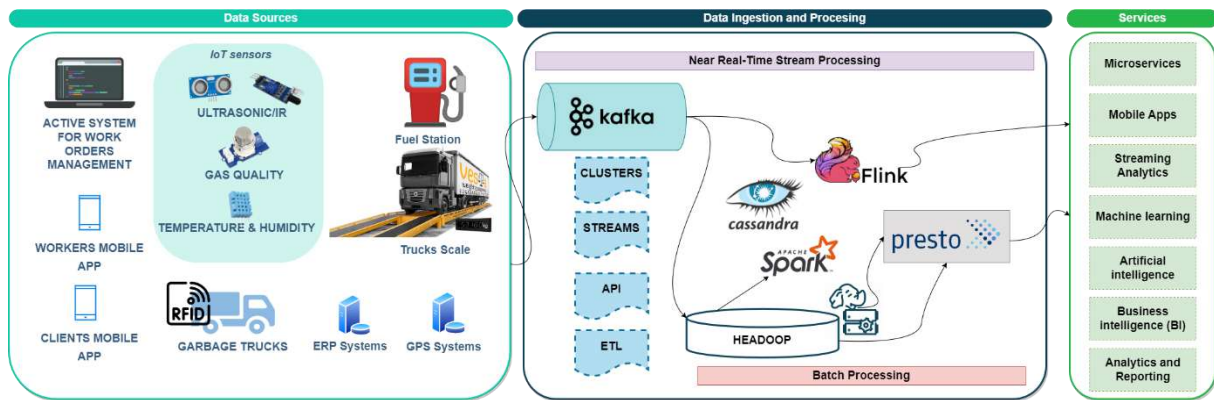

Fig. 1. Data architecture proposal for smart waste management [Source: Authors]

Web applications should provide some freedom and payment for middle management in order to allow the system to be prepared for eventual planned events when there will be certain overloading or reduction of garbage collection needs.

**Mobile applications for truck drivers** are essential for navigation, but also communication and the collection of data on changes and information in the waste removal system.

**Mobile applications for clients**, especially business ones, are essential for effective communication and reactions to the real needs of citizens.

Business clients should also be able to use web applications for active systems for tracking waste removal, especially in the sense of statistics and the need to plan their own business needs for waste removal.

In addition to the standard architecture that uses Spark and HADOOP for data collection and their post-processing and ML model training for more efficient decision-making, the key moments of the proposed data architecture are in the use of Apache Kafka.

Apache Kafka, as a distributed event store and stream-processing platform, will provide a unified, high-throughput, low-latency services for handling real-time data feeds.

Proposed data architecture should use Kafka in its full capacities to provide use cases as:

- Streaming ETL (extract, transform, load),
- APIs,
- IoT Event Fulfillment,
- Log Management

The optional use include Cassandra db as NoSQL database management system designed to handle large amounts of data.

Kafka will work with Flink to process data streams at a large scale and to deliver real-time analytical insights about processed data with our application and microservices.

Proposed data architecture will also include HADOOP and SPARK processes for standard batch and real-data analysis and transformation processes.

Presto (including PrestoDB, and Trino), as a distributed query engine for big data, will be using as a main engine for the queries.

For the efficient functioning of the system, it is necessary to create an appropriate back-end infrastructure in the form of microservices and API platforms that will enable an efficient flow of information and the integration of all systems, including web and mobile applications, as well as external tools that can be found in key places of system management, such as scales or pumps.

The proposed architecture is at a certain level of abstraction, and it is necessary to adjust it in the case of implementation with the corresponding deepening of the details, especially in connection and interoperability of all waste removal subsystems.

#### 4 Potential advantages and opportunities of proposed architecture

The proposed data architecture should enable a wide range of services related to reporting, analytics, business intelligence, but also services related to processes in near real time, which will include a system of dynamic and near-real time

management of the company's business processes, with the aim of timely response to changes in internal or external environment.

The key advantage is reflected in the possibility of connecting different components of the system with real time processing of data before their use on web or mobile platforms, as well as the possibility of placing the same or selectively selected data in data plans for post-processing and ML processes for training new learning models.

Processing in real time will enable an efficient response of the system to the needs of clients and citizens, along with the efficient use of mobile applications that will leave the impression of continuous monitoring of the entire waste collection system.

## 5 Conclusion and Future works

The proposed data architecture represents the initial basis for the use of big data technologies in waste management systems, with the aim of creating a model that observes the entire and wider aspect from a business perspective sufficient for a certain level of managerial decision-making in real time.

On the other hand, in future development, the proposed architecture will deal with the more detailed development of the architecture in terms of ensuring conditions and processes that will enable a certain autonomy of the system and reacting in near-real time to changes that will include internal parameters of business processes as well as external changes in the environment or personal user requests.

## References

1. Vu Do Dung, Georges Kaddoum, A Waste City Management System for Smart Cities Applications, Conference: Advances in Wireless and Optical Communications (RTUWO), October 2017, DOI: 10.1109/RTUWO.2017.8228538
2. Minhaz Uddin Sohag, Amit Kumer Podder.: Smart garbage management system for a sustainable urban life: An IoT based application. Internet of Things 11, 100255 (2020). <https://doi.org/10.1016/j.iot.2020.100255>
3. Tran Anh Khoa, Cao Hoang Phuc, Pham Duc Lam, Le Mai Bao Nhu, Nguyen Minh Trong, Nguyen Thi Hoang Phuong, Nguyen Van Dung, Nguyen Tan-Y, Hoang Nam Nguyen and Dang Ngoc Minh Duc, Waste Management System Using IoT-Based Machine Learning in University, Hindawi. Wireless Communications and Mobile Computing Volume 2020, Article ID 6138637, 13 pages, <https://doi.org/10.1155/2020/6138637>
4. A. Belin Jude, Deepmala Singh, Saiful Islam, An Artificial Intelligence Based Predictive Approach for Smart Waste Management, August 2021, Wireless Personal Communications 127(1):1-21, DOI:10.1007/s11277-021-08803-7
5. Cheema, S.M.; Hannan, A.; Pires, I.M. Smart Waste Management and Classification Systems Using Cutting Edge Approach. Sustainability 2022, 14, 10226. <https://doi.org/10.3390/su141610226>,
6. Insung Hong, Sunghoi Park, Beomseok Lee, Jaekeun Lee, Daebeom Jeong and Sehyun Park, IoT-Based Smart Garbage System for Efficient Food Waste Management, Recent Advances on Internet of Things, Volume 2014, 646953, <https://doi.org/10.1155/2014/646953>
7. Aayush Doshi, Bhavya Shah, Jubin Kamdar, BINTERNET: Smart Waste Management System, International Journal for Research in Applied Science & Engineering Technology (IJRASET) ISSN: 2321-9653; Volume 9 Issue XI Nov 2021
8. Big Data Architecture: Detailed Overview, <https://medium.datadriveninvestor.com/big-data-architecture-detailed-overview-7d2fe1dfcc29>

# Machine learning modeling for reducing greenhouse gas emissions in urban areas

Amel Kosovac, Adisa Medić, Muhamed Begović

University of Sarajevo, Faculty of Traffic and Communications, Zmaja od Bosne 8, Sarajevo 71 000, Bosnia and Herzegovina

## Abstract

The transport sector is one of the main contributors to global warming and carbon dioxide emissions and it is crucial to find sustainable solutions that balance economic, social, and environmental factors for long-term development. Machine learning and neural networks have the potential to significantly reduce greenhouse gas emissions in urban areas by optimizing transportation systems and reducing energy consumption. The main purpose of this paper is to identify the applications of machine learning and neural networks in reducing greenhouse gas emissions. The current topics of applying machine learning and neural networks in reducing greenhouse gas emissions have been synthesized. These technologies are useful for traffic prediction, prediction of the concentration of greenhouse gases, detection of environmental law violators, and route optimization, etc. Finally, recommendations for future research are at the end of the paper.

**Keywords:** Machine Learning, Neural Networks, greenhouse gases, reduction, urban areas, city

## 1 Introduction

Emission of harmful gases in urban environments is an important research topic because urbanization and the increasing population in cities have a significant impact on the environment and human health. Urban environments are often exposed to increased levels of air pollution due to traffic, industrial facilities, and heating.

The main substances emitted into the air are carbon dioxide (CO<sub>2</sub>), nitrogen oxide (NO<sub>2</sub>), sulfur dioxide (SO<sub>2</sub>), and ozone (O<sub>3</sub>), and they have different effects on the environment. Therefore, managing the emission of harmful gases plays an important role in sustainable development and environmental protection. As the world moves towards cleaner energy and lower emissions of harmful gases, understanding and implementing new technologies and policies becomes increasingly important.

In addition to the use of renewable energy sources, electric vehicles and bicycles, drones in delivery, robots and automation [1], sustainability in urban areas is achieved through the use of modern technologies and innovative

transportation approaches. Recently, machine learning has received great attention in the green supply chain as it has the potential to dramatically improve the sustainability and efficiency of supply chains [2].

The application of machine learning in order to reduce greenhouse gas emissions in urban areas is an active research area. Research on this topic has shown that there is sufficient literature on the possibilities that machine learning offers in this field. However, these possibilities have been individually processed, so this paper provides an overview of the literature and a systematic analysis of the potential of machine learning in this area.

This is the main goal of the paper. The areas of application for ML methods have been identified.

Conceptually, the paper consists of five thematic sections. In the introduction, the subject and research objective is defined, followed by the second chapter which deals with the issue of greenhouse gas emissions in cities. The third chapter provides insight into the conceptual meaning of machine learning and neural networks as artificial intelligence technologies. The fourth

---

Corresponding author: Adisa Medić (adisa.medic@fsk.unsa.ba)

© 2023 The Author(s). This work is licensed under a Creative Commons Attribution 4.0 International License.

chapter presents the areas of application of machine learning and neural networks to reduce harmful emissions, followed by the concluding remarks in the fifth chapter.

## 2 Greenhouse gas emission in urban areas

Urban areas are the main sources of greenhouse gas emissions [3] and represent a complex problem that has enormous consequences for the environment and climate. The increased number of inhabitants in cities and the growing demand for delivery and transportation of various types of goods leads to traffic congestion and the emission of harmful gases. By using fossil fuels, vehicles cause the emission of carbon dioxide, nitrogen oxide and other harmful particles that impair the quality of life in urban areas [4].

Freight transport in cities accounts for 16-50% of air pollutant emissions [5]. The impact of freight transportation in cities is also discussed by the authors in the paper [6], where the impact of emissions is divided into three groups:

- the global impact such as climate change and acidity,
- local influence such as air pollution, noise, vibrations and
- consumption of materials, energy and space.

For these reasons, the sustainability of urban areas is of great importance for environmental protection and refers to the management of traffic flows in urban areas in a way that minimizes the negative impact on the environment. In addition to the application of alternative fuels, it also includes artificial intelligence technologies that have a huge impact on the sustainable management chain and the integration of ecological processes [7].

Machine learning and neural networks as technologies for overcoming air pollution challenges are discussed in more detail in Sections 3 and 4.

## 3 Machine learning and artificial neural networks

Machine learning (ML) is a branch of artificial intelligence that deals with the development of algorithms and techniques that can teach computers how to solve problems without explicit programming. The idea is to equip computers with algorithms capable of spotting patterns in

data and based on them making decisions, recognizing forms, and predict future events. Artificial intelligence is a broad term that encompasses the application of machine learning techniques, neural networks and deep learning [8].

As Fig. 1 shows, there are six components that make up a generic machine learning model:

- The input data set is a component that aims to acquire and prepare data to be used for model training. This phase includes data from various sources, such as databases, text documents, images or videos. After that, the data is prepared in a form suitable for further analysis and only the relevant characteristics for the algorithm are defined.

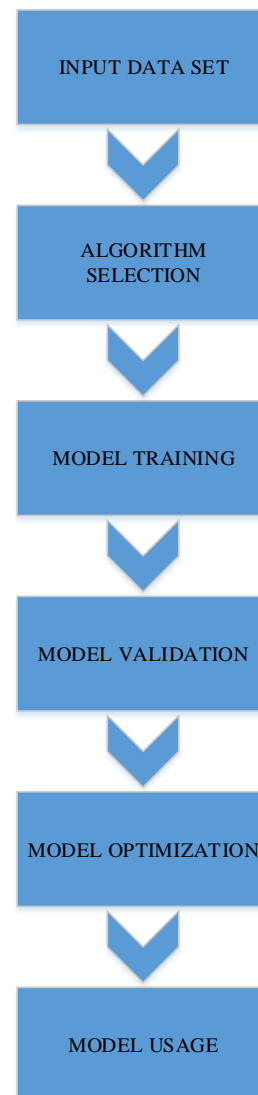

Fig. 1. Generic machine learning model

- The choice of algorithm depends on the problem to be solved and the data set. When choosing an algorithm, the type of task, amount of available data, and their variety.
- After selecting the appropriate algorithm and appropriate parameter values, the model trains on the input data and learns how to recognize patterns and characteristics, and based on that, predicts the output values.
- Model validation includes an assessment how well the model generally performs on new, unseen data and helps identify whether the model is over- or under-fitted. It is evaluated based on the parameters of accuracy, precision and recall.
- Model optimization involves optimizing the hyperparameters of the model in order to achieve better performance.
- Model usage - applying the trained model to predict new values or make decisions based on new data.

There are three main techniques that machine learning uses: supervised, unsupervised, and reinforcement learning. In supervised learning, the algorithm works with labeled data, where it maps the input variable to the output and predicts the result. In unsupervised learning, algorithms recognize patterns in data and derive rules based on them. Reinforcement learning algorithms involve interaction between the system and the environment. The agent or AI-powered system has an initial and final state and encounters different paths to achieve the ultimate goal.

Artificial Neural Networks (ANN), also known as Neural Networks (NN), are a part of artificial intelligence and are designed based on the human brain. The structure of a neural network consists of a series of individual units, artificial neurons or processing elements connected by weight values. Each individual unit has weighted inputs, transfer functions, and outputs.

The weights are parameters that can be adjusted, and in this sense, the neural network is a parameterized system [9]. Input data pass through the network, and each neuron processes the input values it receives by combining them with its weight values and applying an activation function to generate an output.

The output from one neuron becomes the input to the next neuron in the network, allowing the neural network to learn complex patterns in data (see Fig. 2).

They are used for pattern recognition, classification, prediction, and generating new data.

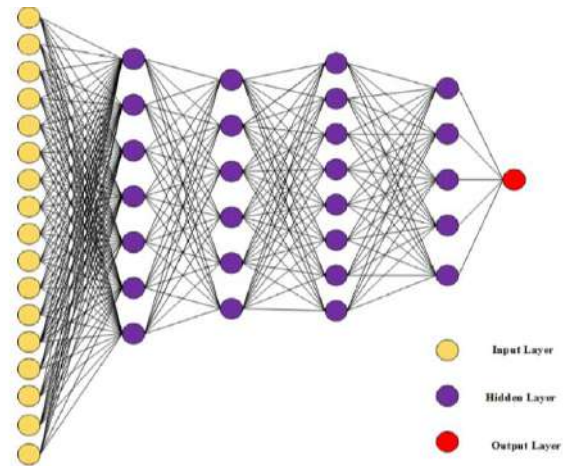

**Fig. 2.** Flow diagram of ANN algorithm for predicting greenhouse gas emissions [10]

The technology of machine learning, which is capable of imitating human intelligence, relies on various disciplines such as artificial intelligence, probability and statistics, computer science, information theory, psychology, and has a wide range of applications in different fields such as pattern recognition, computer vision, engineering, finance, entertainment [11], marketing, telecommunications, analytics [12].

The following section discusses the application of machine learning for environmental protection and reducing greenhouse gas emissions.

#### 4 Machine learning for reducing greenhouse gas emissions in cities

Sustainable urban logistics is achieved through changes in consumer habits, the use of innovative transportation approaches, and modern technologies.

Machine learning and neural networks can provide a significant contribution to improving sustainability in the transportation sector and reducing real-time CO<sub>2</sub> emissions (Fig. 3).



**Fig. 3.** The potential of machine learning and neural networks in reducing greenhouse gas emissions

In paper [13], the authors propose a model for detecting environmental law violators in the context of harmful gas emissions.

The prediction model uses machine learning techniques on two sets of data:

- A dataset of daily environmental pollutant emission activities, such as average and mean gas concentrations, deviations, reported by production plants.
- A dataset of a list of companies previously identified as environmental violators.

Machine learning methods were used to identify factories that emit high levels of harmful gases and deviate from typical emission patterns.

Paper [14] describes a model for predicting CO<sub>2</sub> emissions in multiple stages, including predicting missing values in data sets, clustering, and machine learning techniques. The main objective of this study is to reduce the complexity of the model and improve the accuracy of CO<sub>2</sub> emissions prediction.

The application of machine learning methods for calculating data on carbon dioxide emissions for cities is also discussed in paper [15].

In this process, collaboration and support at all decision-making levels, from individuals to governments, are particularly important to achieve significant reductions in air pollution in

urban areas and preserve the quality of life and health of people.

By employing decision trees and random forest algorithms, this study identified the key determinants of carbon dioxide emissions, such as socioeconomic factors, humidity, average temperature, and precipitation. The analysis revealed significant variation in emissions levels among different cities.

The application of machine learning in the field of testing air pollution with greenhouse gases is discussed and recommended in papers [16] and [10].

In [17], the authors proposed an artificial intelligence and Internet of Things-based model for controlling urban traffic with the aim of reducing greenhouse gas emissions in urban areas. Mathematical models of traffic flow and intersections were primarily proposed to reduce congestion and, consequently, negative environmental impacts, followed by a deep learning model for predicting urban traffic. The model relies on the application of a neural network to predict traffic flows based on traffic data, weather conditions, and other relevant factors. After obtaining predicted traffic flows, the authors used this information to optimize routes and delivery schedules in urban areas, with the goal of reducing overall greenhouse gas emissions.

Neural networks are also used for air quality forecasting [18]. The model predicts the concentration of particulate matter, nitrogen dioxide, and sulfur dioxide for five days in advance at thirty-two different locations in Delhi. The model was trained on meteorological parameters and hourly pollution concentration data for the year 2018.

To evaluate the concentration of nitrogen dioxide in the air, the authors conducted a study for the city of Tehran in paper [19]. To predict the daily concentration of NO<sub>2</sub> in the air, they used data on urban traffic, green areas, weather, and meteorological parameters as input variables. Prediction was performed using a neural network model and regression analysis method, where the neural network model showed more accurate predictions.

Neural networks can also be used for modeling ozone and simulating its behavior in relation to other atmospheric parameters of interest, as

shown by the authors in [20], who conducted a simulation on a model in Thessaloniki, Greece.

The potential applications of neural networks in transportation and the analytical possibilities it offers in this area are also mentioned by the authors in [21].

## 5 Conclusion

This paper thoroughly investigated and analyzed the role that machine learning and neural networks have in reducing the harmful effects of greenhouse gases on the environment. Based on the analysis of relevant literature, it can be concluded that ML and ANN models are very significant for operational use in managing air quality in cities and have great potential for future research activities in the field of environmental protection. The prediction and identification of the biggest environmental pollutants is what these tools offer, and the accuracy in the prediction forms the basis for the management and planning of greenhouse gas emissions. By comparing different sources of pollution and greenhouse gas emissions, it is possible to identify the main sources of pollution and potentially define measures to reduce emissions in the most effective way, as well as make decisions related to environmental protection and climate change.

ML and NN-based models can also help predict future pollution emissions, which can be useful in planning long-term emission reduction measures and selecting technologies to be used. They are also useful in the field of urban traffic control. Based on information obtained by predicting traffic flows, routes and schedules of vehicle movements in urban areas are optimized, which directly affects the reduction of overall greenhouse gas emissions.

Although it offers a number of advantages, the impact that this technology has on the environment should also be taken into account. Due to the great need for energy-efficient models and insufficiently covered topics in the literature, this area is recommended for future research.

## References

[1] H. Fatorachian and H. Kazemi, "The Management of Operations Impact of Industry 4.0 on supply chain performance," *Prod. Plan. Control*, vol. 0, no. 0, pp. 1–19, 2020, doi: 10.1080/09537287.2020.1712487.

[2] V. Kumar, H. S. Pallathadka, S. Kumar Sharma, C. M. Thakar, M. Singh, and L. K. Pallathadka, "Role of machine learning in green supply chain management and operations management," *Mater. Today Proc.*, vol. 51, no. 8, pp. 2485–2489, 2022.

[3] C. L. C. Chang and C. S. P. Chiueh, "Correlation between land-use change and greenhouse gas emissions in urban areas," no. Stone 2009, 2013, doi: 10.1007/s13762-012-0155-2.

[4] S. M. Mirhedayatian and S. Yan, "A framework to evaluate policy options for supporting electric vehicles in urban freight transport," *Transp. Res. Part D*, vol. 58, no. November 2017, pp. 22–38, 2018, doi: 10.1016/j.trd.2017.11.007.

[5] M. Lindholm and S. Behrends, "Challenges in urban freight transport planning - a review in the Baltic Sea Region," *J. Transp. Geogr.*, vol. 22, pp. 129–136, 2012, doi: 10.1016/j.jtrangeo.2012.01.001.

[6] S. Zečević and S. Tadić, *City logistika*. Beograd: Univerzitet u Beogradu Saobraćajni fakultet, 2013.

[7] L. Bastida, J. J. Cohen, A. Kollmann, A. Moya, and J. Reichl, "Exploring the role of ICT on household behavioural energy efficiency to mitigate global warming," *Renew. Sustain. Energy Rev.*, vol. 103, no. January, pp. 455–462, 2019, doi: 10.1016/j.rser.2019.01.004.

[8] Hui Lin Ong, R. Doong, R. Naguib, C. P. Lim, and A. K. Nagar, *Artificial Intelligence and Environmental Sustainability Challenges and Solutions in the Era of Industry 4.0*.

[9] R. Beresford, "Basic concepts of artificial neural network ( ANN ) modeling and its application in pharmaceutical research," vol. 22, pp. 717–727, 2000.

[10] M. Emami and S. F. Ghaderi, "A Hybrid Model with Applying Machine Learning Algorithms and Optimization Model to Forecast Greenhouse Gas Emissions with Energy Market Data," *Sustain. Cities Soc.*, vol. 82, no. March, p. 103886, 2022, doi: 10.1016/j.scs.2022.103886.



- [11] I. El Naqa and M. J. Murphy, "What Is Machine Learning?," pp. 3–11, doi: 10.1007/978-3-319-18305-3. 1319, 2007, doi: 10.1016/j.simpat.2007.09.005.
- [12] W. Hua and A. R. Learning, "A Brief Review of Machine Learning and its Application," 2009.
- [13] X. Chang, Y. Huang, M. Li, X. Bo, and S. Kumar, "Efficient Detection of Environmental Violators: A Big Data Approach," *Prod. Oper. Manag.*, 2020, doi: 10.1111/poms.13272.
- [14] A. Mardani, H. Liao, and M. Nilashi, "A multi-stage method to predict carbon dioxide emissions using dimensionality reduction , clustering , and machine learning techniques," vol. 275, 2020, doi: 10.1016/j.jclepro.2020.122942.
- [15] J. Qin and N. Gong, "The estimation of the carbon dioxide emission and driving factors in China based on machine learning methods," *Sustain. Prod. Consum.*, vol. 33, pp. 218–229, 2022, doi: 10.1016/j.spc.2022.06.027.
- [16] M. Brauer *et al.*, "Examination of monitoring approaches for ambient air pollution : A case study for India," *Atmos. Environ.*, vol. 216, no. December 2018, p. 116940, 2019, doi: 10.1016/j.atmosenv.2019.116940.
- [17] L. Terrada, M. El Kha, A. Daaif, and H. Ouajji, "Towards a Green Supply Chain Based on Smart Urban Traffic Using Deep Learning Approach," vol. 10, no. February, pp. 25–44, 2022, doi: 10.19139/soic-2310-5070-1203.
- [18] S. Agarwal, S. Sharma, S. R. M. H. Rahman, S. Vranckx, and B. Maiheu, "Air quality forecasting using artificial neural networks with real time dynamic error correction in highly polluted regions. Sci," *Sci Total Env.* 735139454, 2020.
- [19] S. R. Shams, A. Jahani, S. Kalantary, and M. Moeinaddini, "Artificial intelligence accuracy assessment in - NO<sub>2</sub> concentration forecasting of metropolises air," *Sci. Rep.*, no. 2, pp. 1–9, 2021, doi: 10.1038/s41598-021-81455-6.
- [20] K. D. Karatzas and S. Kaltsatos, "Air pollution modelling with the aid of computational intelligence methods in Thessaloniki , Greece," vol. 15, pp. 1310–
- [21] A. Al-surmi, M. Bashiri, and I. Koliouisis, "AI based decision making : combining strategies to improve operational performance," 2022, doi: 10.1080/00207543.2021.1966540.

# Create sustainable and smart mobility in the Western Balkans country

Samir Džaferović<sup>1</sup>, Mirza Berković<sup>2</sup>, Adnan Omerhodžić<sup>2</sup>

<sup>1</sup>Ministry of Communication and Transport of Bosnia and Herzegovina,  
Trg BiH 1, Sarajevo 71 000, Bosnia and Herzegovina

<sup>2</sup>University of Sarajevo, Faculty of Traffic and Communications,  
Zmaja od Bosne 8, 71 000 Sarajevo, Bosnia and Herzegovina

## Abstract

Climate change and environmental degradation are existential threats to Europe and the world. In paper we discuss on how to create a climate resilient, intelligent, and resource-efficient transport network in the Western Balkans. Making transport cleaner and sustainable is must be one of the key drivers of transport policy in Western Balkans. With the final aim of making transport greener, sustainable, and healthier for citizens of Western Balkans. In addition, the Western Balkans region is affected by climate change and has already experienced its severe consequences of climate change. In the coming period, the countries of the Western Balkans should develop and implement joint regional actions, that will contribute to the creation of sustainable and smart mobility. Joint regional measures of the country should be developed in more detail according to the organization of the country. The paper presents current situation, and the future main joint regional actions aimed at creating sustainable and smart mobility of the countries of the Western Balkans.

**Keywords:** *Regional actions, Sustainable, Smart, Mobility, Emissions, Create*

## 1 Introduction

The positive side of the transport sector is reflected in the movement of people and material goods, but at the same time it is a source of great pressure on the environment and climate, with the participation of about ¼ in the creation of all greenhouse gases, with a particularly pronounced impact of road traffic.

The future of Europe and the world depends on a healthy planet. Facing current challenges in the field of climate and environment requires an urgent and ambitious response. The EU has committed itself to achieving climate neutrality by 2050. To achieve this goal, a transformation of European society and economy is required, which must be cost-effective, fair and socially balanced.

The European Green Plan represents the EU's strategy for achieving the climate goal for 2050, it

contains a package of initiatives in the area of policies aimed at ensuring the green transition of the EU, with the ultimate goal being to achieve climate neutrality by 2050.

It supports the transformation of the EU into a just and prosperous society with a modern and competitive economy. It emphasizes the need for a comprehensive and cross-sectoral approach in which all relevant policy areas contribute to the ultimate climate goal. The package includes initiatives in the fields of climate, environment, energy, transport, industry, agriculture and sustainable financing. The paper deals in detail with the area of transport, the importance of the implementation of the EU strategy for sustainable and smart mobility, as well as the future activities of the countries of the Western Balkans.

---

Corresponding author: Samir Džaferović ([samir.dzaferovic@fsk.unsa.ba](mailto:samir.dzaferovic@fsk.unsa.ba))

© 2023 The Author(s). This work is licensed under a Creative Commons Attribution 4.0 International License.

The countries of the Western Balkans are greatly influenced by climate change. Namely, in the previous period they experienced the negative consequences of climate change, and as a region they are seen as one of the most affected by climate change in Europe. With regard to the impact of the transport sector of the countries of the Western Balkans on climate change, five subcategories stand out, namely: road, rail and air transport, as well as transport by sea and inland waterways. The paper will also present three scenarios regarding the generation of harmful substances, financial savings and energy consumption until 2050.

## 2 The impact of the EU transport sector on the climate and environment

From 1980 to 2020, more than 138,000 people lost their lives due to extreme weather conditions and phenomena related to climate change. The year 2020 was recorded as the hottest year in Europe, and in the last 5 years the average temperature was 2.2 °C higher than at the end of the 19th century. Financial losses as a result of climate change have cost Europe more than 487,000 billion euros in the last 40 years. Floods cost Europe more than 5 billion euros every year, and fires cost more than 2 billion.

In the EU, five sectors (transport, agriculture, construction, small industry and waste) account for 60% of total greenhouse gas emissions. Each country should contribute to the reduction of greenhouse gases in all sectors, adopting a series of regulations and establishing marginal annual pollution limits by sector. Figure 1. shows the projection of greenhouse gas emissions in EU member states until 2030.



Fig. 1. Projection of greenhouse gases in EU member states until 2030. [1]

When it comes to the transport sector, it accounts for about 25% of greenhouse gas emissions in the EU. According to the European Green Plan, today about 75% of land cargo is transported by road, which in the future should be partly transported by rail and inland waterways. Urgent action is therefore needed as relatively little progress has been made so far: for example, the modal share of railways in land freight transport fell from 18.3% in 2011 to 17.9% in 2018. In the Fig. 2., the % presentation of the origin of emissions according to the type of traffic is given.

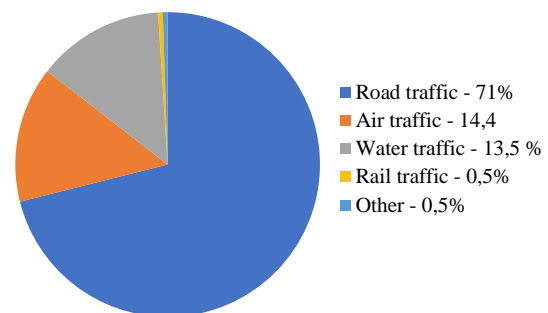

Fig. 2. Share of emissions by type of traffic [2]

When it comes to CO<sub>2</sub> emissions, cars and vans are responsible for about 15% of the total emissions in the EU, as shown in the Fig. 3.

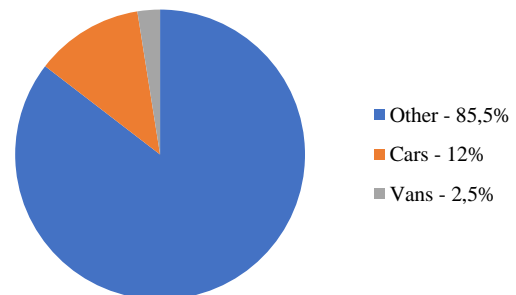

Fig. 3. Generation of CO<sub>2</sub> emissions from cars and van [3]

The greening of mobility must become a new basis for the growth of the transport sector. Mobility in Europe should be based on an efficient and interconnected multimodal passenger and freight transport system enhanced by an affordable high-speed rail network, widely available zero-emission vehicle charging infrastructure. In this sense, reducing the use of fossil fuels in transport is crucial for the EU to become climate neutral by 2050. In order to

achieve this goal, there must be enough charging stations for electric vehicles and alternative fuel stations for the cars, planes and ships that use them in the EU.

The regulation on infrastructure for alternative fuels, which is part of the package "Ready for 55%", sets concrete goals for the development of such infrastructure in the EU in the coming years.

From the mentioned approach, the expected benefits are reflected above all for citizens, consumers and the automotive industry, which is explained in more detail in the Fig. 4.

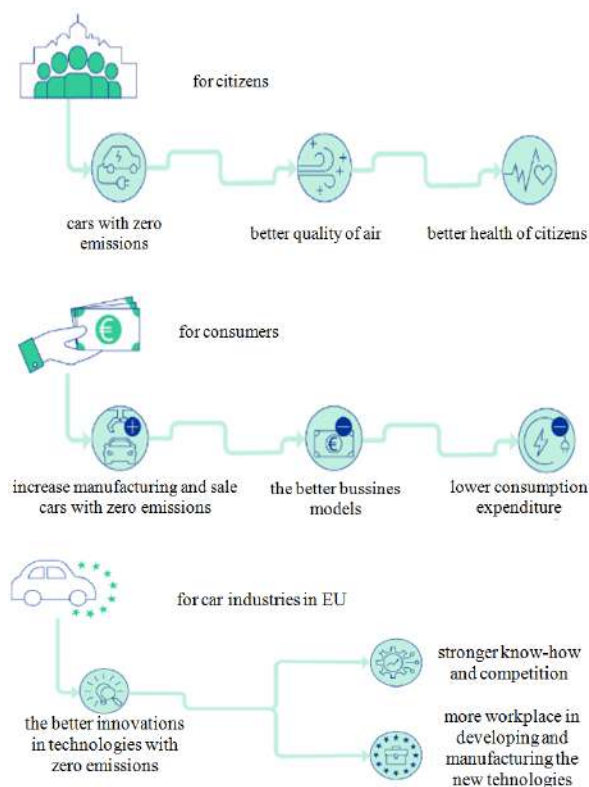

**Fig. 4.** Expected benefits for citizens, consumers and the automotive industry [3]

At the end of 2019, the European Commission announced a new growth strategy, called the European Green Plan. The strategy should enable sustainable and inclusive growth, the implementation of the United Nations program until 2030 and the goals of sustainable development, and the transition towards a just and prosperous society with a modern, resource-efficient and competitive economy in which there will be no greenhouse gas emissions in 2050. Policies for the implementation of the new general growth strategy, i.e. the European Green Plan, include:

- Climate policy,
- Energy policy (for the supply of clean energy throughout the economy),
- Industrial policy and circular economy,
- Construction,
- Environmental protection and biodiversity,
- Agriculture and tourism (for the implementation of "from field to table" initiatives),
- Mobility,
- Social policy,
- Research, development and innovation.

Adequate action in the field of sustainable and smart mobility requires a multidisciplinary approach at different levels, from the creation of strategic documents, planning and design to the use and application of specific technical solutions.

The effective response of society to negative phenomena in the transport sector, i.e. the creation of an effective system of protection, requires the creation of a deliberate, branched, planned, elaborated, synchronized system of diverse and interconnected organizational, social, educational, educational, technical, economic and other results based on science, measures and activities that will reduce the risk accompanying the development of a complex system of movement of people and goods to environmentally acceptable limits. In order to break the chain between the causes and the negative consequences of the transport sector, before the consequences occur, all factors that contribute to the negative impact of the transport sector on the climate and the environment must be respected, as well as their dynamic connection.

## 2.1 Sustainable and smart mobility of the countries of the Western Balkans

The countries of the Western Balkans in the previous period were greatly influenced by climate change, and as a region they are seen as one of the most affected by climate change in Europe. The estimated increase in temperature was from 1.7-4°C, with an estimate that it will be up to 5°C in the coming period, depending on the global effort to reduce greenhouse gas emissions.

The main source of greenhouse gases in the countries of the Western Balkans are the energy and transport sectors, which account for two thirds of the total share of greenhouse gases. The

transport sector accounted for about 12% of greenhouse gases in 1990, while its share increased to 16% by 2018. In the total share of emissions, road traffic is dominant with a share of more than 90%, which is especially pronounced in urban areas of the region, as well as areas with a large number of inhabitants.

Within the framework of the Permanent Secretariat of the Transport Community, in mid-2021, the Sustainable and Smart Mobility Strategy of the Western Balkan countries was adopted, which is based on the European Green Plan. In this sense, the strategy includes sustainable, smart and resilient mobility as key elements, as well as 10 initiatives. [5]

The strategy presents guidelines for the development of the region's transport sector with the aim of creating a greener, smarter and more resilient transport system, which will be integrated into the EU transport system according to the highest standards. It also represents the basis for the development of national mobility strategies, with the aim of achieving the set results by 2030 and 2050.

Through the defined action plan of the strategy, it is necessary to undertake activities on the improvement of the legislative framework, development of transport infrastructure and ITS, as well as institutional strengthening, within the suggested time frames.

### **2.1.1 The current situation in the countries of the Western Balkans**

In all countries of the Western Balkans, the transport sector is based mainly on non-renewable energy sources for road, water and air transport, electricity and diesel for railway transport.

Road transport is the predominant mode of transport. The use of electric and hybrid road vehicles in the countries of the Western Balkans is low compared to the EU.

The implementation of energy efficiency measures in the transport sector is just at the beginning. The shortcoming is reflected in the absence of a unified approach to determining emission standards by the competent authorities, which ranges from Euro 3 as the lowest to Euro 6 as the highest Euro norm.<sup>3</sup>

Rail transport, zero-emission vehicles rely on electric traction because there is no infrastructure or means of transport that can use other types of alternative fuels. There are no means of transport with zero emissions in waterborne air transport.

There are two key parameters for reducing greenhouse gases, which are reflected in:

- the total energy consumed - which is based on the kilometers traveled and the type of means of transport, and
- to the greenhouse gas emission factor of energy consumed.

The key drivers that affect both the traffic model and then the energy/greenhouse model are reflected in:

- The population is growing,
- Growth of the gross domestic product,
- Total kilometers traveled,
- Composition of the fleet,
- Fuel economy,
- Emission factors, and
- The emission factor from the network.

In the absence of action, annual greenhouse gas emissions could be expected to more than double between 2019 and 2050. Total projected greenhouse gas emissions are expected to increase from 8.3 million tCO<sub>2</sub> in 2019 to 18.0 million tCO<sub>2</sub> in 2050. [5]

It can be noted that the main driver of the increase in greenhouse gas emissions in the region is fuel consumption in road transport, especially due to the increased use of passenger cars. Based on the estimated baseline scenario projections, it is evident that significant progress is necessary in the region for: policy intervention and investment in infrastructure, change of transport mode, change of fuel and renewal of the vehicle fleet.

We can observe the future activities of the countries of the Western Balkans through three scenarios:

1. Do Nothing scenario emissions describes the state of the system against which changes are measured: greenhouse gas emissions in the

---

<sup>3</sup> Import of M1 category, Euro V used and Euro VI new vehicles is allowed in Bosnia and Herzegovina.

transport sector are expected to almost double by 2050;

2. The "Do Something scenario emissions" scenario is an acceptable description of the future that describes how the (studied) system will respond to the implementation of certain policies and measures;

3. The decarbonization scenario "Decarbonization scenario emissions" implies full implementation measures.

In the following figure, according to three scenarios, the projection of tCO<sub>2</sub> generation by year until 2050 in the countries of the Western Balkans is given. [4-5]

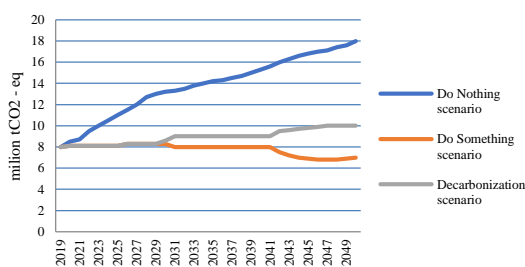

**Fig. 5.** Generation of tCO<sub>2</sub> by years in the countries of the WB according to scenarios

Table 1. shows the projection of energy consumption in the countries of the Western Balkans [6] according to three scenarios until 2050.

**Table 1.** Energy consumption by year and scenario

Depending on the applied scenario [6], the projection of financial savings in the following period is given in table 2.

**Table 2.** Projection of financial savings according to scenarios expressed in billions of euros

	2030	2040	2050
Do Nothing scenario	0.0	0.0	0.0
Do Something scenario	8.2	34.5	75.0
Decarbonization scenario	8.8	40.8	99.6

## 2.2 Sustainable and smart mobility of Bosnia and Herzegovina

Bosnia and Herzegovina has adopted the Framework Transport Policy for the period 2015-2030. year, which is a framework and basic document, on the basis of which the development strategy, regulations, programs, plans and other acts were adopted in the process of progress and development of the transport sector, and to decide

on development directions, action plans and priorities at the level of Bosnia and Herzegovina, its entities and Brčko District of Bosnia and Herzegovina, and in accordance with the Constitution of Bosnia and Herzegovina.

As a follow-up to the stated policy, the Framework Traffic Strategy of Bosnia and Herzegovina for the period 2016-2030 was adopted, which describes in detail the implementation of the Transport Policy until 2030. The framework transport strategy determines the procedures and programs to be undertaken (administrative reforms, regulatory harmonization, capacity building and investment programs), as well as the corresponding distribution of responsibilities, time frame and key performance indicators. [7-9]

The European Commission in Bosnia and Herzegovina selected consultants in order to further update the Framework Traffic Strategy of Bosnia and Herzegovina, which resulted in a final document at the end of 2022, which was submitted to the Ministry of Communications and Transport of Bosnia and Herzegovina for further processing. [7-9]

Further activities aimed at the adoption of the aforementioned document require consideration by the competent bodies in Bosnia and Herzegovina and adoption by the Council of Ministers of Bosnia and Herzegovina. The above should ultimately ensure the further integration of the BiH transport sector into the EU transport sector, according to the highest standards and

		2030	2040	2050
Energy consumption on per RP (MWh/year)	Albania	4,207,119	3,786,886	2,617,169
	Bosnia and Herzegovina	5,053,133	3,991,572	2,577,427
	Kosovo	3,100,050	2,869,005	2,052,239
	Montenegro	1,129,182	864,076	602,603
	North Macedonia	4,887,384	4,750,646	2,908,254
	Serbia	12,722,336	10,465,760	4,849,448
Decarbonisation scenario energy consumption (WB6 total)		31,099,204	26,727,945	15,607,140
Do Something scenario energy consumption (WB6 total)		32,029,462	31,937,095	31,141,451
Do Nothing scenario energy consumption (WB6 total)		41,993,735	54,821,886	60,920,665

legal norms.

## 3 Conclusion

The recovery from the crisis caused by the COVID-19 disease pandemic should be used to accelerate the decarbonization and modernization of the entire transport and mobility system, limiting its negative impact on the environment

and improving the safety and health of citizens. The parallel green and digital transition should reshape the transport sector, redefine connectivity and revive the economic sector. The transformation, which must be fair, will not be easy and will have to be fully committed to and supported by all participants in the transport sector, and investments from the public and private sectors that stimulate growth will have to be significantly increased.

The sustainable European transport system that the EU strives for must be smart, flexible and adaptable to changing traffic patterns and needs, and be based on the most modern technological achievements in order to ensure smooth, safe and protected connectivity for all citizens. Transport should be an indicator of European ingenuity and craftsmanship, a driver of research, innovation and entrepreneurship, and a driving force of the double transition. For the countries of the Western Balkans, a comprehensive set of measures is proposed towards the creation of a sustainable, smart and resilient mobility system of the future and the introduction of fundamental changes necessary to achieve the goals of the European Green Plan. Also, further synchronized elaboration at the national levels of the measures proposed in the Strategy for Sustainable and Smart Mobility of the Western Balkan countries is needed. Given the importance of joint actions, the achievement of a common goal can only succeed with sufficient commitment from all interested parties, specifically the institutions of the Western Balkan countries and their bodies at all levels of government, participants, companies and citizens.

5. Technical Assistance for the Deployment of Smart and Sustainable Mobility in the Western Balkans, Podgorica 30.03.2023.
6. European Commission: "European Green Plan", Brussels, European Commission, 2019.
7. Framework transport policy of BiH 2015-2030, 2015.
8. Framework strategy of transport of BiH 2016-2030, 2016
9. Transport Community, Strategy for sustainable and smart mobility in the WB, Belgrade, 2021.

## References

1. Fit for 55: "Reducing emissions from transport, buildings, agriculture and waste", Consilium (europa.eu), <https://www.consilium.europa.eu/en/infographics/fit-for-55-effort-sharing-regulation/>
2. European Commission: "European Green Plan", Report no. COM (2019) 640. Brussels, European Commission, 2019b.
3. Fit for 55: "Council adopts regulation on CO<sub>2</sub> emissions for new cars and vans", <https://www.consilium.europa.eu/en/press/press-releases/2023/03/28/fit-for-55-council-adopts-regulation-on-co2-emissions-for-new-cars-and-vans/>
4. GAP Analysis: "Strategy for sustainable and smart mobility in the Western Balkan"





## ATCT 2023 - KEYNOTE SPEAKERS

SENIOR DEPUTY DIRECTOR, JAPAN INTERNATIONAL COOPERATION AGENCY (JICA)

### **Keisuke Tanaka**



Mr Tanaka joined the Ministry of Land, Infrastructure, Transport and Tourism (MLIT) in Japan in 2007. He was responsible for various public transport projects in Tokyo and other cities in Japan such as the railway improvement project, the public transport company's reform project, and the transport policy reform projects to encourage people to use more buses in Japan.

From 2015-2018, He worked for the Japanese Embassy in Malaysia as a transport specialist to improve the public transport system in the country. From 2019, he works for the Japan International Cooperation Agency(JICA) to be responsible for international cooperation projects in the field of the public transportation worldwide. In 2020, he started the 'Project for Formation of Sarajevo Public Transport Management and Operation Capacity Development Plan' together with the Ministry of Traffic in Sarajevo.

He holds the Master of Science in Geography at the University of Oxford in the UK.

INSTITUTE FOR ENERGY SYSTEMS AND ELECTRIC DRIVES,  
TECHNICAL UNIVERSITY OF VIENNA

### **Amela Ajanović**



Amela Ajanovic is Associated Professor in Energy Economics at Vienna University of Technology (TU Wien). She is a lecture and faculty member of the postgraduate MSc Program "Renewable Energy Systems". She holds a master degree in electrical engineering and a PhD in energy economics at TU Wien. Her main research interests are alternative fuels and alternative automotive technologies as well as sustainable energy system and long-term energy scenarios. She has been guest researcher at the Energy Research Centre of the Netherlands (ECN) in Amsterdam and at the International Energy Agency (IEA) in Paris working on the World Energy Outlook, as well as a guest lecturer at the Technical University of Prague. She has been involved in many national and international research projects, and her work has been published in the leading scientific peer- reviewed international journals. She has also served as a guest editor on several occasions and is an associate editor of different scientific journals. She is an active member of various academic and scientific committees and associations.

DEPARTMENT OF ENVIRONMENT, LAND AND  
INFRASTRUCTURE ENGINEERING (DIATI), POLITECNICO  
UNIVERSITY OF TURIN

**Bruno Dalla Chiara**



Bruno Dalla Chiara is full professor in the “Transport systems” academic field – including transport engineering, science and technology – at the Politecnico di Torino (Dept. DIATI), Italy, since 2019. He obtained the national qualification as full Professor in Transport Systems in 2014. He holds a M.Sc. in Mechanical Engineering, specialising in transport systems engineering and economics (1993), and a Ph.D. in Transport Engineering, specialising in Intelligent Transport Systems (1997). He has been full-time Researcher in Transport Engineering at the Politecnico di Torino (1999-2004) and associate professor (2005-2019). He holds the subjects “Rail transport systems, urban transit and rope installations”, “Transport systems and outdoor logistics”, has held part of “Mobility”, “Transport techniques and economics”, “Transport systems and data analytics” and “Sustainable transport systems” (Ph.D.).  
[\[https://www.polito.it/en/staff?p=bruno.dallachiara\]](https://www.polito.it/en/staff?p=bruno.dallachiara)

REGIONAL PROJECT MANAGER, GERMAN DEVELOPMENT  
AGENCY FOR INTERNATIONAL COOPERATION (GIZ)

**Milenka Mila Knežević**



Milenka Mila Knežević is a graduate of the Faculty of Technology at the University of East Sarajevo, with a Master’s degree in technology. She is currently employed at Deutsche Gesellschaft für Internationale Zusammenarbeit (GIZ) GmbH – the German government’s development agency for economic cooperation and development (BMZ) – as a regional project manager in the Open Regional Fund for Southeast Europe – Energy, Transport, and Climate Protection (ORF ETC).

Within ORF ETC, she leads a sub-project called Promoting Regional Exchange in the Implementation of Sustainable Urban Mobility Plans in the Western Balkans – ProSUMP. The aim of this sub-project is to support cities in Southeast Europe in strengthening the capacity of local governments to implement sustainable urban mobility measures, with a focus on previously created Sustainable Urban Mobility Plans (SUMP).

Her previous experience includes working as an advisor in the Open Regional Fund for Southeast Europe – Energy, Transport, and Climate Protection (GIZ), as well as in the Open Regional Fund for Southeast Europe – Energy Efficiency (GIZ), and in the EuProLocal program for local self-government units and economic development. She has also worked as the Head of Department for Development, and International Cooperation and Public Procurement in the City of Zvornik initiating the establishment of the first office for Energy Efficiency in BiH.

In addition to her professional experience, she has skills as a trainer in communication and negotiation, strategic planning, and project cycle management.

## Organizer



Faculty of  
Traffic and Communications



Institute of  
Traffic and Communications

## Supported by



Ministry of  
Communications and Transport

## Sponsored by



\*JP BH POŠTA\* d.o.o. Sarajevo



Moja priča.



MEMBER OF asee



Grad Sarajevo



EURO-ASFALT



Međunarodni prijenos novca

