

Injected Fuel Mass and Flow Rate Control in Internal Combustion Engines: A Systematic Literature Review

*Original*

Injected Fuel Mass and Flow Rate Control in Internal Combustion Engines: A Systematic Literature Review / Ferrari, Alessandro; Gurri, Simona; Vento, Oscar. - In: ENERGIES. - ISSN 1996-1073. - 17:24(2024). [10.3390/en17246455]

*Availability:*

This version is available at: 11583/2996024 since: 2024-12-30T20:29:37Z

*Publisher:*

MDPI

*Published*

DOI:10.3390/en17246455

*Terms of use:*

This article is made available under terms and conditions as specified in the corresponding bibliographic description in the repository

*Publisher copyright*

(Article begins on next page)

# Injected Fuel Mass and Flow Rate Control in Internal Combustion Engines: A Systematic Literature Review

Alessandro Ferrari , Simona Gurri  and Oscar Vento \* 

Energy Department, Politecnico di Torino, Corso Duca degli Abruzzi, 29, 10129 Torino, Italy; alessandro.ferrari@polito.it (A.F.); simona.gurri@polito.it (S.G.)

\* Correspondence: oscar.vento@polito.it

**Abstract:** Advancements in fuel injection systems have dramatically improved the precision of controlling injected fuel mass or flow rate; a key factor in optimizing internal combustion engine (ICE) performance, emissions control, and fuel efficiency. This review systematically analyzes 145 scientific research papers from the last two decades, including older foundational works, tracing the evolution of injected mass control from early Bosch and Zeuch meters to advanced machine learning or physical models. This study draws upon research collected from the most reputable databases. Through both qualitative and quantitative analyses, the state-of-the-art of these systems is presented, and key innovations are highlighted regarding advanced control algorithms and real-time feedback mechanisms under various operational conditions such as high or transient loads and multi-stage injection strategies. Special attention is given to challenges in maintaining precise control with alternative fuels like biodiesel, hydrogen, or synthetic fuels, which exhibit different physical properties compared to traditional fuels. The findings emphasize the need for further research on injection control, especially in light of stringent emissions regulations. Improving these systems for next-generation ICEs is a key point for achieving cleaner, more efficient combustion and bridging the sustainability gap between traditional and future mobility solutions.

**Keywords:** systematic review; injected fuel mass control; internal combustion engine



**Citation:** Ferrari, A.; Gurri, S.; Vento, O. Injected Fuel Mass and Flow Rate Control in Internal Combustion Engines: A Systematic Literature Review. *Energies* **2024**, *17*, 6455. <https://doi.org/10.3390/en17246455>

Academic Editor: Anastassios M. Stamatelos

Received: 31 October 2024

Revised: 17 December 2024

Accepted: 18 December 2024

Published: 21 December 2024

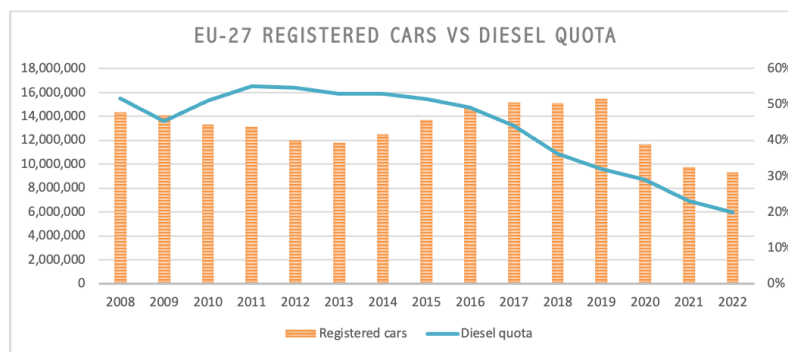


**Copyright:** © 2024 by the authors. Licensee MDPI, Basel, Switzerland. This article is an open access article distributed under the terms and conditions of the Creative Commons Attribution (CC BY) license (<https://creativecommons.org/licenses/by/4.0/>).

## 1. Introduction

The automotive industry has experienced a profound transformation over the past decade, with major shifts in both technological development and consumer perceptions. Among the pivotal moments in this period was the 2015 Dieselgate scandal, which fundamentally reshaped the inclination toward diesel engines. The scandal centered on Volkswagen's conscious manipulation of emissions tests to present its diesel vehicles as eco-friendly, in particular by reducing declared levels of nitrogen oxides (NO<sub>x</sub>). These pollutants, which are connected to high environmental and health risks, have been under regulatory measures for a long time [1,2], but the exposure of this event had extensive consequences, from the loss of consumer trust in diesel technology to the re-evaluation of emission standards worldwide.

Before Dieselgate, diesel engines dominated the European automotive market [3], accounting for more than 50% of all new vehicle registrations. Their popularity derived from their higher fuel efficiency and therefore lower CO<sub>2</sub> emissions compared to gasoline engines [4], making them attractive in a regulatory environment focused on reducing greenhouse gas emissions. However, by 2023, diesel's market share had dropped to just 13% of new vehicle registrations [5]. It is possible to appreciate the trend during the last years in Figure 1. This decline reflects not only the erosion of consumer confidence, but more importantly, the regulatory recoil that followed the scandal. Dieselgate catalyzed a wave of more stringent emissions regulations, accelerating the industry's shift away from diesel toward alternative powertrains and technologies that promise lower tailpipe emissions and higher local environmental sustainability.

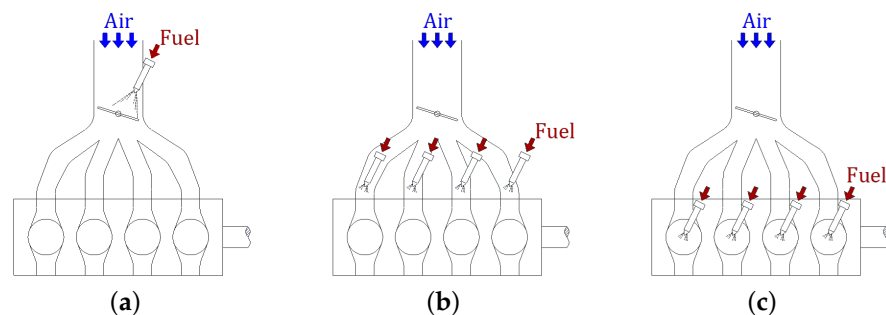


**Figure 1.** New registered cars per year in EU-27 and the percentage of diesel cars. Data from ICCT European Vehicle Market Statistics Pocketbook [3].

The ramifications of the Dieselgate scandal are emblematic of a broader trend in the automotive industry, but also in general toward increased environmental awareness. From here comes the push for more efficient, lower-emission vehicles. This framework, while not new at the time, has led to the tightening of emission standards like Euro 6-d [6] and the impending Euro 7 regulations [7], and to the introduction of Real Driving Emissions (RDEs) [8] type approvals in 2017, whose goal is to further reduce allowable NO<sub>x</sub> and particulate emissions in real driving scenarios. These standards apply not only to diesel engines but to all internal combustion engines (ICEs), driving continuous advancements in engine technology in an attempt to remain competitive with battery or fuel cell vehicles from the point of view of sustainability as well. A key area of innovation for ICEs has been fuel injection systems, which are central to improving engine efficiency while minimizing emissions.

Fuel injection systems, responsible for delivering fuel to the combustion chamber, play a crucial role in determining the performance, efficiency, and emission profile of internal combustion engines [9]. Two primary approaches in fuel injection are Port Fuel Injection (PFI) and Direct Injection (DI), as in Figure 2. PFI involves injecting fuel into the intake manifold, where it mixes with air before entering the combustion chamber. This method offers simplicity, cost-effectiveness, and lower particulate emissions due to better premixing of air and fuel [10]. These attributes make PFI systems particularly suitable for naturally aspirated gasoline engines and hybrid powertrains, where affordability, reliability, and ease of maintenance are critical. PFI systems are often found in economy-focused vehicles, where low complexity and consistent performance are advantageous. However, their limitations, such as low injection pressures and less precise fuel quantity control, restrict their ability to support advanced combustion strategies like lean-burn or stratified charging.

In contrast, DI systems inject fuel directly into the combustion chamber at a high pressure, enabling precise control of the air–fuel mixture and supporting advanced strategies such as multiple injection events and stratified charging. These features result in improved efficiency, power output, and reduced CO<sub>2</sub> emissions, especially under variable engine loads. However, DI systems come with increased costs and complexity due to the need for high-pressure pumps, advanced injectors, and additional after-treatment systems to mitigate particulate emissions [10]. DI is well-suited for turbocharged and high-compression engines, including performance-oriented gasoline and diesel powertrains. These systems are commonly used in diesel engines, sports cars, heavy-duty trucks, and where there is a demand for high power and efficiency while meeting stringent emissions standards.



**Figure 2.** Different fuel injection arrangements—(a) single-point PFI; (b) multi-point PFI; (c) direct in-cylinder injection (DI).

Technological advancements in fuel injection, especially in controlling the precise mass or mass flow rate of injected fuel, have been one of the factors helping to meet more stringent emission standards. For diesel engines, innovations like common rail injection systems allow for high-pressure fuel delivery and multiple injection events within a single combustion cycle. These systems provide precise control over the fuel–air mixture, enhancing combustion efficiency and reducing  $\text{NO}_x$  and particulate emissions, thereby enabling diesel engines to better compete with gasoline engines in terms of emissions [11]. However, the post-Dieselsgate shift has redirected research and development efforts toward gasoline engines, leading to the growing adoption of gasoline direct injection (GDI) systems [12]. Similar to diesel’s common rail systems, GDI technology involves high-pressure fuel injection directly into the combustion chamber, and it has become a focal point for researchers and manufacturers seeking to balance performance, efficiency, and emission reductions in gasoline-powered vehicles.

Although improvements in fuel injection systems dramatically enhanced the performance of petrol and diesel internal combustion vehicles, in order to combat climate change, a ban on fossil fuels has been proposed by the European Union. Therefore, the automotive industry is now being forced to adapt, moving towards alternative fuels used in internal combustion engines. This transition is motivated by both regulatory pressures and the growing demand for sustainable energy sources. Biofuels, hydrogen, and synthetic fuels can be considered as promising alternatives to conventional hydrocarbons, although each of them presents unique advantages and challenges, especially with regard to the topic of this paper, i.e., fuel injection systems. For example, biofuels—such as the renewable origin of biodiesel—offer potential carbon emission reductions, but due to their higher viscosity and lower volatility, their use in existing fuel injection systems is problematic [13]. Therefore, the research focuses on adapting injected quantity control strategies to handle the different physical–chemical characteristics of these fuels. Hydrogen, considered a GHG-neutral fuel, presents its own challenges, including low energy density and high combustion reactivity. These require precise injection control to prevent pre-ignition and knocking; factors that can compromise engine performance and durability [14].

This systematic review is justified by the growing importance of precise control over the injected fuel mass in addressing critical global challenges related to energy efficiency and environmental sustainability. As transportation remains a significant contributor to greenhouse gas (GHG) emissions, optimizing fuel injection systems directly supports reductions in  $\text{CO}_2$  and particulate emissions, particularly in high-emitting sectors like heavy-duty transport. Improved injection control enhances combustion efficiency, which translates to lower fuel consumption and reduced reliance on fossil fuels, aligning with energy efficiency goals. The fuel injected mass control becomes crucial, considering that most of the open-loop engine strategies depend on the ECU prediction of fuel flow rate. Therefore, the effectiveness of these open-loop strategies, tuned during the dynamic test bench calibration, depends on the accuracy of this prediction. As a consequence, closed-loop real-time knowledge of the injected fuel quantity allows the engine to adopt the best calibration for the actual working conditions.

Additionally, as alternative fuels such as hydrogen, ammonia, and biodiesel gain prominence, precise injection control is essential to managing their unique combustion characteristics, ensuring compatibility with existing engine technologies and supporting the transition to sustainable transportation. To this end, advanced control algorithms are being studied, including real-time feedback systems that are capable of correcting the injected mass quantity depending on engine operating conditions. Recent literature reviews have provided valuable insights into existing fuel injection models and control strategies. For example, Mata's review [15] provides a broad overview of fuel injection control models, particularly zero-dimensional (0-D) models, which are computationally efficient but may lack the necessary details for predictive control under dynamic conditions. Other previous reviews [16–19] have shed light on some types of fuel injection control and measurements, but, being dated, lack insights into recent advances, particularly in areas such as machine learning and adaptive control algorithms for real-time applications. Understanding the critical role that fuel injection systems play in the evolution of internal combustion engines in the current historical context of energy transition, this review aims to provide a comprehensive and up-to-date summary of the latest advances in fuel mass control in internal combustion engine vehicles. This work differs from the previous ones both in its methodology, i.e., a systematic classification, and in the approaches analyzed, including advancements in machine learning applications and real-time adaptive control strategies for both conventional and alternative fuel solutions. This review will classify current control approaches, highlight key innovations that have improved the efficiency of combustion and emission reductions, and identify gaps in the existing literature.

This review is organized as follows: Section 2 details the systematic approach used to gather and analyze relevant literature on mass fuel injection control. Sections 3 and 4 provide an in-depth review of current technologies and strategies for mass fuel injection control, with a focus on the challenges and opportunities associated with alternative fuels. Finally, Section 5 summarizes key findings and proposes future research directions for the optimization of fuel injection systems for next-generation ICEs.

## 2. Materials and Methods

A systematic literature review (SLR) is chosen as the methodology, as it is a rigorous approach designed to comprehensively identify, evaluate, and synthesize existing research on a specific topic [20,21]. This approach is valued for minimizing bias, ensuring transparency, and providing a structured overview of the current state of the art. By following these principles, a SLR makes it easier to gain a more objective understanding of the literature and points out areas where further research is needed.

This section summarizes how this review was carried out. First, the research questions were clearly defined to guide the search process; next, the appropriate databases were selected to ensure a comprehensive but meaningful coverage of the literature. The search was made using a set of relevant keywords, which were developed to refine the results. Finally, before starting the studying process, inclusion and exclusion criteria were established to filter the relevant studies. This review follows the PRISMA 2020 checklist. This review has not been registered.

### 2.1. Research Question Definitions

Research questions (RQs) provide a clear and focused framework for research, analysis and synthesis of the literature. The research questions for this review were chosen to capture the full range of advances in injected mass control technologies, encompassing every existing approach in order to classify them and ultimately to be able to identify future research directions. These questions ensure that the selected bibliography is relevant and aligned with the objectives of the review.

*RQ1: What is the state of the art of injected mass control in ICEs?* This question aims to provide a comprehensive overview of current advances in the field. All key technologies,

methodologies, and innovations used in injected mass control are explored so that an overview of state-of-the-art fuel injection system control can be obtained.

*RQ2: How can current approaches to injected mass control be classified?* Once the state of the art is clear, the goal is to classify the various techniques and strategies used for injected mass control, providing a structured overview of the methods employed in ICEs. By classifying the relevant literature, this question helps to quantify and organize the scientific publications, providing a clearer understanding of the field and enabling statistical conclusions to be drawn on which topics are most relevant or which techniques are most commonly used.

*RQ3: What are the future research directions concerning the control of injected mass in ICEs?* The purpose of this last question is to address gaps in the current literature, with the aim of highlighting under-researched areas and proposing potential future research directions.

## 2.2. Database Selection

The selection of databases used to source the cited literature ensures that the search is comprehensive and relevant to the field of fuel injection systems in automotive engineering, and that it responds robustly to the RQs that have been posed. Therefore, it has been decided to use three major academic search engines for this review, which are considered reliable due to their reputation in the scientific community and their relevance to the topics of internal combustion engines and fuel injection systems. More precisely:

**Google Scholar:** Provides access to a wide range of interdisciplinary research, including conference papers, journal articles, and patents. Its comprehensiveness makes it the most-used tool for identifying important work in various fields.

**Scopus:** Offers detailed citation analysis and has a robust filtering system for high-quality peer-reviewed articles, particularly in engineering and applied sciences.

**Web of Science:** Having a comprehensive indexing of high-impact journals, Web of Science is ideal for tracking the evolution of research topics and understanding the citation dynamics in a particular field.

## 2.3. Keyword Selection

To implement an in-depth query, a list of keywords was developed. They were selected to include both broad and specific aspects of injected mass control in ICEs, with the aim of capturing a comprehensive spectrum of papers for the search. Keywords were also created to include terminology variations and were combined with Boolean operators to refine the search, especially to limit the results to ICEs.

The key search words included the following:

- “Injected mass control”
- “Fuel injection systems”
- “Rate of injection”
- “Alternative fuels injection”
- “Injected mass quantity”
- “Internal combustion engines”

## 2.4. Inclusion Criteria

Inclusion criteria were established to ensure the quality and relevance of the selected literature. The criteria were designed to screen the literature in order to specifically focus on finding peer-reviewed papers that directly addressed the control of injected mass in ICEs in a somewhat exclusive manner.

The inclusion criteria were as follows:

- **Peer-reviewed articles:** To ensure the quality and reliability of the results, only studies published in reputable, peer-reviewed journals were considered, without applying a lower threshold to the number of citations.
- **Recent studies:** Articles published within the last 20 years were prioritized to ensure that this review reflects current trends and advances in the field. Foundational works

that are frequently cited in more recent studies were included to recognize their continued relevance.

- Focus on injected mass control: Research directly related to techniques for controlling the mass of fuel injected into internal combustion engine vehicles, whether for petrol, diesel, or alternative fuels, was included.
- Geographical diversity: Studies from different regions were considered to provide a global perspective on advances in fuel injection technology.

### 2.5. Exclusion Criteria

Exclusion criteria were also applied for the same purpose as the inclusion criteria, including:

- Non-peer-reviewed papers: Theses, conference papers, and results that did not undergo peer review were excluded in order to maintain the integrity of the review.
- Non-English-language articles: Only studies published in English were considered, as most high-impact research in this field is published in English.
- Obsolete research: Studies that do not reflect the current state of the art were excluded, particularly those published before 2000, unless they were foundational works.
- Irrelevant topics: Research focusing on injection systems for unrelated applications (e.g., turbine combustors, catalytic systems) or on aspects of fuel injection unrelated to mass control (e.g., emission modeling or combustion optimization) were excluded.

### 2.6. Limitations of the Systematic Literature Review, Difficulties, and Shortcomings

Although this review uses a rigorous methodology to ensure comprehensive coverage of relevant literature, some limitations are acknowledged. First, the inclusion criterion for language limits the literature to studies in English, which may exclude relevant findings published in other languages, particularly from regions where alternative fuel technologies are heavily studied.

Furthermore, the focus on peer-reviewed articles ensures quality and reliability but may exclude advanced developments presented in conference papers, patents, or technical reports that are not formally published. Given the strong industrialization of fuel injection technologies, it is possible that some concepts may not have been taken into full consideration in this review. Finally, although an attempt was made to include seminal studies published before 2000, the emphasis on recent literature means that earlier foundational work may be under-represented unless directly cited in more recent studies.

As can be appreciated in the remainder of this paper, the key step, and therefore the one that required the most time and attention, was to define the micro and macro categories into which each work fit. In fact, only after selecting the works to be examined was it possible to draw borders between the various categories. It will be seen that, along with the others, a “hybrid” approach exists; that is, one that exploits multiple methodologies. The creation of this latter category was taken into account only after a while, as it was seen to represent a breakthrough approach for the future of the field.

### 2.7. Quantitative and Qualitative Analysis

The selected literature was analyzed both quantitatively and qualitatively to ensure a comprehensive assessment of trends, technological advances, and research gaps. A framework was developed to interpret the results, linking the findings directly to the research questions. The framework includes the synthesis of the results, in which quantitative data are integrated with qualitative data to provide a comprehensive overview of the field.

#### 2.7.1. Quantitative Analysis

The quantitative analysis in this systematic literature review aims to provide a statistical overview of the research on injected mass control in ICEs. The analysis will focus on several key metrics reflecting trends in publication volume, citation impact, and geographical distribution of relevant literature.

First, the annual number of publications will be examined to assess whether interest in the field of fuel injection control systems has been unchanged over time. Furthermore, citation analysis will be used to assess the impact of specific studies in the broader context of automotive engineering. By analyzing the number of citations and the quality of the journals, it is possible to identify the most influential papers in the field, thus highlighting their contribution to advances in fuel-injected mass or mass flow control technologies.

In addition to examining publication and citation trends, the geographical distribution of the research will also be analyzed in order to discover the leading regions and institutions contributing to the development of fuel injection technologies. By analyzing publication trends across countries, it will be possible to understand how different regulatory environments and technological priorities influence the directions and outcomes of injected mass control research.

This multifaceted quantitative approach will facilitate a broader understanding of the evolution of injected mass control research in recent years.

### 2.7.2. Qualitative Analysis

The qualitative analysis will complement the analysis performed, with a focus on identifying and synthesizing key themes, methodologies, and research gaps within the studied field. A central aspect of this analysis will be the classification of control methodologies employed in fuel injection systems in order to answer one of the RQs of this systematic review. Using the above research methodology, the investigation will encompass a broad spectrum of mass measurement or estimation techniques, ranging from traditional instrumental measurement to advanced approaches incorporating real-time adaptive control and machine learning algorithms. The study of different methodologies is crucial because they can be useful in improving engine performance and reducing emissions.

In addition, special attention will be paid to the compatibility of injection technologies with alternative fuels, including biodiesel, hydrogen, and synthetic fuels. As the automotive industry shifts to these new energy sources, it becomes imperative to understand how and whether existing injection systems can adapt to different fuel properties. This analysis will include the specific challenges related to the impact that variations in the chemical and physical properties of the fuel have on the injected quantity.

Finally, one of the main goals of the qualitative analysis is to also answer the third RQ by identifying research gaps, particularly in under-explored areas such as adaptive control under varying transient engine conditions, adaptability of injection system control to gaseous fuels, and scalability of machine learning algorithms for real-time injection control. By highlighting these gaps, this review aims to propose potential avenues for future investigations, thus fostering the continued development of innovative fuel injection technologies.

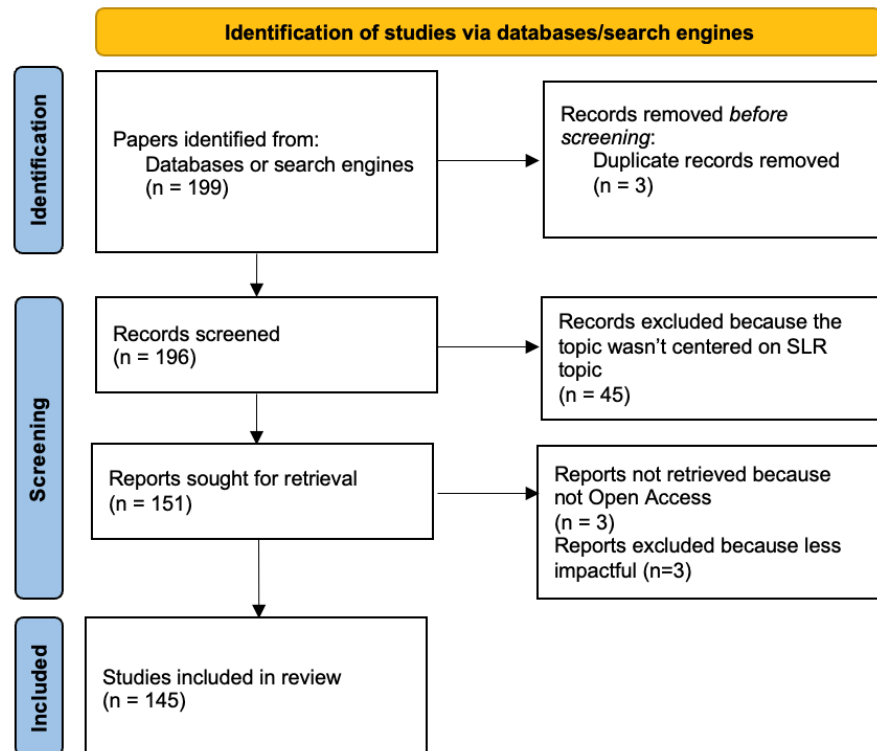
Overall, the qualitative approach will provide a comprehensive assessment of advances and challenges in injected mass control, providing insights into how these technologies can be improved to meet future performance and regulatory requirements. Linking the results of the quantitative and qualitative analyses to established research questions will build a cohesive narrative that encapsulates the current state of the field and illuminates pathways for future research efforts.

## 3. Results

### 3.1. Quantitative Analysis

The first result of this SLR is a presentation of the results of the search, as described in Section 2. In Figure 3, the Preferred Reporting Items for Systematic Reviews and Meta-Analyses (PRISMA) flow chart elucidates the step-by-step screening and identification process of the literature.

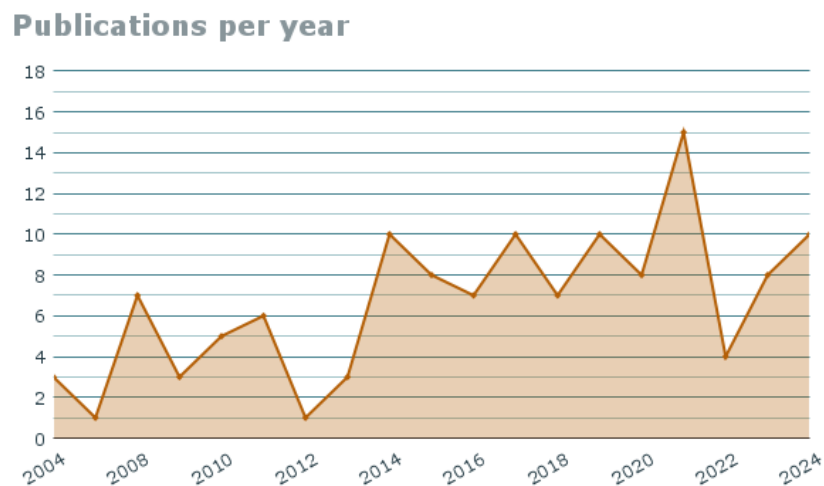




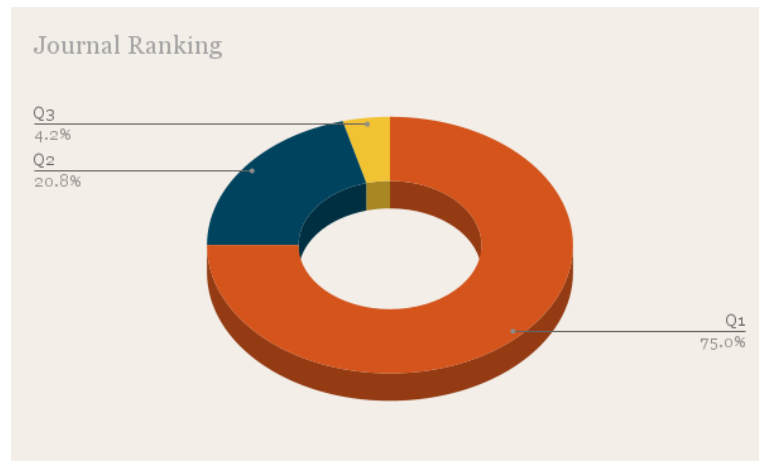
**Figure 3.** Flow chart adapted from PRISMA 2020 for systematic reviews, which included only searches of databases.

The field of injection mass control in ICEs has shown consistent growth since the 1990s, with notable spikes in research output aligning with advancements in computational tools and machine learning capabilities. Foundational work in the 1960s and 1970s established key measurement techniques like [22–25], providing the basis for early model-based approaches. Since then, publications have increased, particularly with the industry’s focus on emission reductions and fuel efficiency in response to regulations like Euro 6 and Euro 7 (Figure 4).

Analyzing the journals in which the papers cited in this work were published, it can be observed that the majority of them are first-quartile journals, denoting a high quality of the contents (Figure 5). The journals that have historically been most interested in the topic are Fuel, International Journal of Engine Research, and Applied Energy, as well as others such as Energy and Measurements.



**Figure 4.** Number of publications considered per year.



**Figure 5.** Journal rankings.

Studies like [26,27] demonstrated the validity of model-based applications, while more recent works have leveraged machine learning for predictive models, enabling real-time adaptive control for varied engine conditions and fuel types [28–30]. This evolution, which is summarized in Table 1, reflects the increasing complexity to injection mass control challenges when alternative, and not necessarily liquid, fuels are considered.

**Table 1.** Evolution of injected mass control methodologies by decade.

Decade	Key Studies	Methodologies	Research Focus
1960s	[22]	Direct measurement using hydraulic measuring tubes	Focused on foundational direct measurement techniques for injection rate accuracy
1970s	[31]	Analytical and initial model-based estimation	Introduced early model-based approaches for estimating fuel injection parameters
1980s	[32,33]	Expansion of direct measurements with advanced flow meters and pressure sensors	Improved accuracy in injection measurements, with growing interest in transient flow dynamics
1990s	[34–36]	Hybrid approaches combining direct measurement and model-based estimation	Focused on integrating real-time data from direct measurements with early computational models
2000s	[37–39]	Advanced model-based methods, including 1D and 0D simulations	Shifted towards computational simulations to model injection systems under varying conditions
2010s	[30,40]	Emergence of machine learning models, integration of real-time feedback in injection control	Increased focus on predictive models, feedback mechanisms, and adapting to variable fuels
2020s	[41–43]	Machine learning, hybrid control strategies, alternative fuel adaptation	Emphasis on adaptive control for alternative fuels, with complex real-time systems for transient conditions

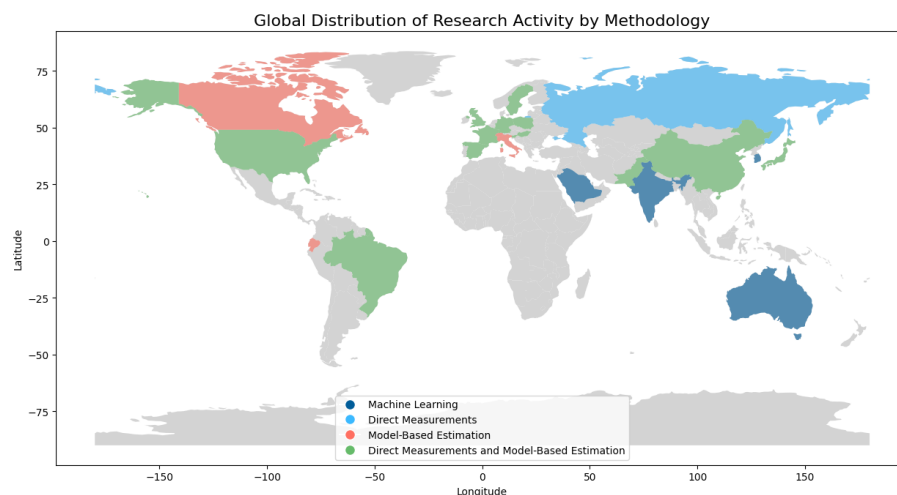
Research on injection control methods is concentrated primarily in Europe, North America, and Asia, with each region contributing distinct advancements. The first two regions have pioneered model-based control and adaptive injection models. Contributions like [44,45] emphasize the development of predictive control mechanisms suitable for diverse engine loads and environmental conditions. It is interesting, in this regard, to note that in Europe or the United States, for example, research is driven by strict environmental policies, and the legislative framework is oriented toward emission reductions, as mentioned in the introduction. From this perspective, the relevant contribution of works that are oriented toward diversified operating conditions should be identified to ensure a broad spectrum of applicability of the increase in system efficiency. Economic constraints are not overly demanding; instead, there is a focus on achieving sustainability goals such as those of the Green Deal, which promotes innovation from the standpoint of new fuels and

new hybrid systems. In the U.S., there is a duality between car manufacturers and the still prolific oil industry versus renewable energy, hybridization, and systems to reduce emissions. The Biden administration reinstated tighter constraints on fuel efficiency targets (CAFE Standards) at the federal level, but some states have taken a stronger edge over others. For example, California has a goal of having 100% of new car sales as zero-emission vehicles (ZEVs) by 2035, implying a shift towards decarbonized fuels and electrification.

Asian research, particularly in recent years, has focused on machine learning applications aimed at enhancing fuel efficiency and enabling alternative fuel adaptability. Recent studies [46,47] have specialized in fuel control systems tailored for specific fuel types, underscoring the region's emphasis on fuel flexibility. It is important to underline that this continent is home to some of the largest and most innovative car manufacturers, always at the forefront of hybridization and energy efficiency. In addition, countries such as China, Japan, and South Korea have established themselves globally in research as leaders in the fields of artificial intelligence and machine learning, with significant investments in these areas. Governments are actively promoting AI development with strategies at the national level as well (e.g., the Chinese case of the “next generation AI development plan”). This environment promotes collaborations between industry and academic research, resulting in rapid developments of new ML techniques and new applications. Lastly, ML technologies applied to this field reduce the cost of the injection control system, as it reduces the need for upgrades at the hardware level and accommodates retrofits.

In addition, South America and Australia have contributed to lower-cost model-based estimations that are suitable for resource-constrained settings, focusing on high flexibility, as shown in references [29,48,49]. Indeed, South American states have many incentives for retrofitting ICEs to meet emission standards, also promoting the use of flex-fuel ICEs, which can be powered by ethanol or biofuels. In this context, economic constraints have the upper hand over environmental ones, yet these are not completely neglected. This is where the lower cost injection control models come from, which are highly beneficial in their intended areas. Australia is also moving on this front, as it is a small player from a market and automotive research perspective in which the high range requirements of vehicles tend to delay the push for electrification.

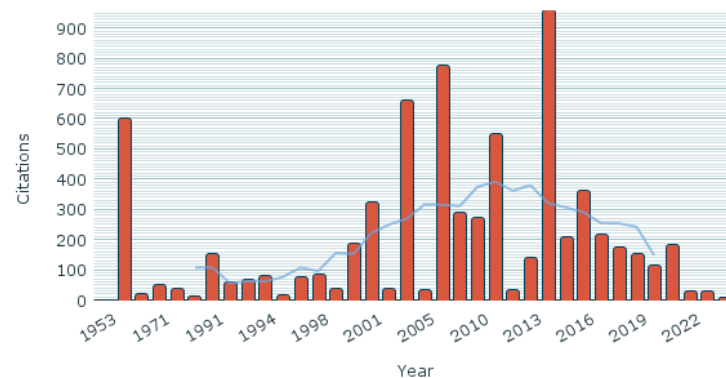
Four main categories will be used in this SLR to systematically categorize the analyzed papers: direct measurements, physical model-based estimations, and machine learning-based models. The fourth category represents the hybrid approaches using direct measurements and models to have a lower cost and better estimates during operations. The global distribution of categories can be seen in Figure 6.



**Figure 6.** Global distribution of research activity based on methodology categories. The colors represent the category for which the given country has contributed the most.

A citation analysis reveals that influential papers typically introduce innovative methodologies or practical applications with widespread implications. Foundational works, particularly those focusing on common rail systems, emissions control, and model-based injection strategies, have high citation counts, indicating their impact on the field. The high number of citations on common rail-related works, and the fact that the peak of citations is around 2014, as it is possible to see in Figure 7, is in line with the historical context at hand. In fact, as already discussed in Section 1, after Dieselgate, interest in the control of injection systems initially decreased, focusing mainly on the optimization of direct injection gasoline systems, and then reawakened in the pursuit of alternatives to fossil fuels.

Citation and year of publication



**Figure 7.** Citations for the papers published in a given year until now. The peak in citations is in 2014.

### 3.2. Qualitative Analysis

#### 3.2.1. Definitions and Terminology

In this section, the definitions and terminology used in the context of fuel injection system analysis are provided. This systematic review examines various fuel injection parameters and their roles in enhancing engine performance, emissions, and combustion efficiency. The terminology discussed here is hence foundational for understanding the dynamics of fuel injection and its effects on combustion characteristics.

#### Fuel Mass Flow Rate ( $\dot{m}_{fuel}$ )

The fuel mass flow rate, denoted as  $\dot{m}_{fuel}$ , represents the amount of fuel delivered into the combustion chamber per unit of time. Accurate control of this rate allows for regulation of the air–fuel ratio and, subsequently, the energy release during combustion. The fuel mass flow rate is critical for achieving precise combustion control.

The mass flow rate of fuel can be expressed as follows:

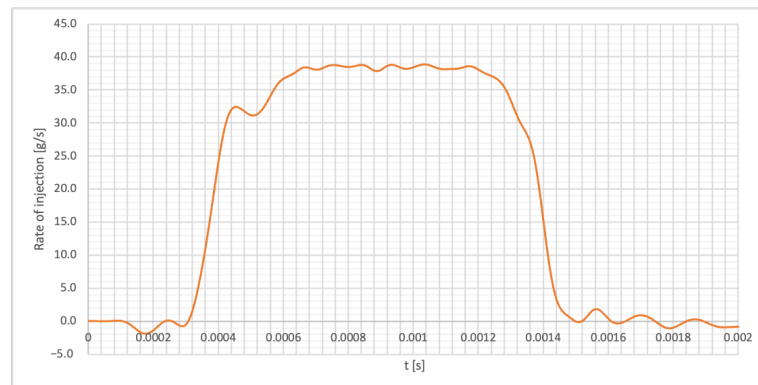
$$\dot{m}_{fuel} = \rho_{fuel} \cdot A_{nozzle} \cdot v_{fuel} \quad (1)$$

where:

- $\rho_{fuel}$  = density of the fuel ( $\text{kg}/\text{m}^3$ ),
- $A_{nozzle}$  = cross-sectional area of the injector nozzle ( $\text{m}^2$ ),
- $v_{fuel}$  = velocity of the fuel through the nozzle ( $\text{m}/\text{s}$ ).

In the context of fuel injection, the mass flow rate is often referred to as the Rate of Injection (ROI). The ROI indicates the speed at which fuel is injected into the combustion chamber, influencing combustion efficiency and emissions [50,51]. The measurement of the ROI for a common rail diesel injector is demonstrated in Figure 8. It quantifies the fuel mass injected per unit of time and takes part in adaptive control strategies that optimize engine performance based on changing conditions [32,52]. Refinements in ROI modeling, especially under transient conditions, have improved engine responsiveness in dynamic

load scenarios [51]. Studies highlight the ROI's role in optimizing droplet size distribution and fuel atomization; both critical for efficient combustion and reduced emissions [53,54].



**Figure 8.** Real measurement of the rate of injection for a diesel common rail injector.

### Fuel Mass ( $m_{fuel}$ )

The fuel mass ( $m_{fuel}$ ) represents the total amount of fuel injected during a single combustion cycle. It is a fundamental factor in determining the air–fuel ratio (AFR), thereby affecting combustion characteristics, power output, and emissions.

The total injected fuel mass is calculated by integrating the rate of injection over the injection event duration, i.e., from  $t_0$  = start of injection to  $t_f$  = end of injection.

### Injection Pressure ( $\Delta P$ )

In this paper, the injection pressure,  $\Delta P$ , is defined as the pressure differential between the fuel rail and the combustion chamber, which is essential for atomizing fuel and improving spray characteristics. It is calculated as follows:

$$\Delta P = P_{rail} - P_{chamber} \quad (2)$$

Commonly, one refers to the rail pressure as the injection pressure, since modern injection systems can efficiently control its value with a closed-loop strategy.

### Air–Fuel Ratio ( $\alpha$ )

The air–fuel ratio,  $\alpha$ , is the mass ratio of air to fuel in the combustion chamber; a parameter to act upon when dealing with combustion and emission optimization:

$$\alpha = \frac{m_{air}}{m_{fuel}} \quad (3)$$

where:

- $m_{air}$  = mass of air in the mixture (kg),
- $m_{fuel}$  = mass of fuel in the mixture (kg).

### Needle Lift ( $h_n$ )

The needle lift ( $h_n$ ) represents the injector needle's displacement, affecting flow area and fuel spray patterns.

### Injection Timing

Injection timing is the point in the engine cycle when fuel is injected, typically measured in crank angle degrees relative to top dead center firing (TDC-f).

### Energizing Time (*ET*) and Dwell Time (*DT*)

The energizing time represents the duration of the signal that triggers the injection, i.e., the duration of the current signal provided by the Electronic Control Unit (ECU) to the pilot stage of a solenoid injector or to the piezo-actuator of a piezoelectric injector. Modern injection strategies, mainly for diesel engines, are based on multiple injections over an engine cycle, enabling efficient combustion, emission control, and performance. Each injection (pilot, main, post) is characterized by a particular *ET* value, and the time interval between consecutive shots is labeled as the dwell time (*DT*).

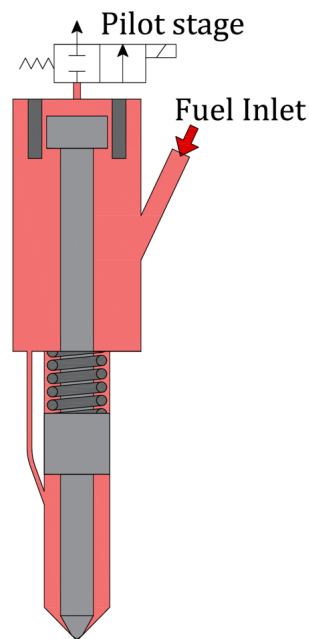
### Types of Injectors and Injection Systems

The injector type influences the precision and responsiveness of fuel delivery, with each type suited to specific applications:

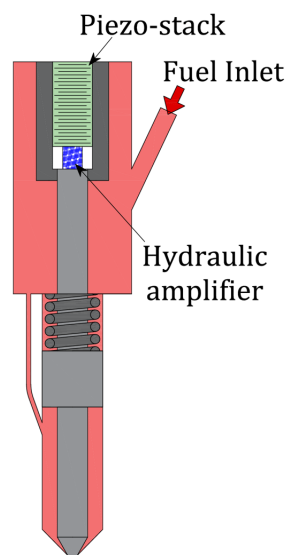
- Solenoid Injector (SI): solenoid-based injectors, common in many diesel engines, rely on magnetic solenoids to open and close pilot valves to manage the needle movement that opens and closes the nozzle holes. While generally more cost-effective, and with good control, they have moderate response times, which can limit precision in applications requiring rapid adjustments, very high injection pressures, or in working conditions featuring multiple closely coupled injections. A scheme of this injector can be found in Figure 9.
- Piezoelectric Injectors (PI): the hydraulic circuit of these injectors features piezoelectric crystals. Piezoelectric injectors can be driven directly, i.e., the piezo stack actuates the needle, or indirectly, where the piezo stack acts on the pilot stage.

The main differences in the hydraulic and engine performance between the solenoid and indirect-acting piezoelectric injectors can mainly be ascribed to the presence of different layout solutions in the internal circuit of the injectors (such as the bypass, the pressure-balanced pilot-valve, and the Minirail) rather than to the injector driving system. If solenoid and indirect acting piezoelectric injectors shared the same internal hydraulic layout, the differences in their performance would be minimal. Therefore, since the manufacturing cost of solenoid injectors is still lower than that of piezoelectric injectors, solenoid technology should be the preferred option when indirect acting injectors are considered [55].

Instead, the direct acting injector, which can only be realized with piezoelectric technology, improves the control of the injection shape, enabling additional strategies (such as boot injection [56]). Moreover, a higher hydraulic efficiency is achieved due to the reduced static leakages. A scheme of a direct acting piezo injector can be found in Figure 10.

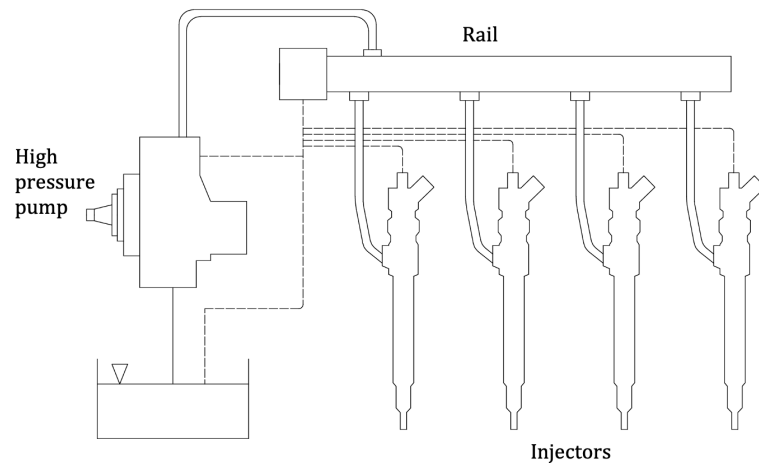


**Figure 9.** Scheme of a solenoid injector.



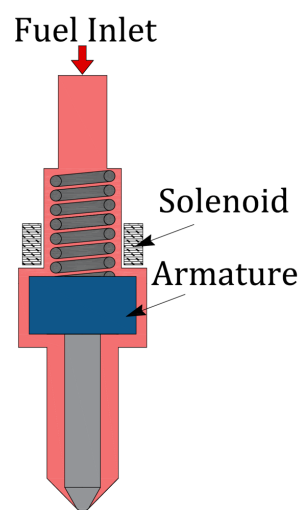
**Figure 10.** Scheme of a direct-acting piezoelectric injector.

- Common rail injector: found in diesel engines, this allows for precise injection timing and pressure control. Common Rail (CR) systems regulate fuel pressure independently of engine speed, providing adaptable fuel delivery across operating conditions [57,58]. Non hydraulically amplified common rail injection systems featuring ultra-high injection pressure, up to 3000 bar, have been developed [59] but did not reach the market. Maximum values of the injection pressure for commercial injectors are around 2700 bar. Most of the applications feature a solenoid-injector architecture. A schematic of the system can be found in Figure 11.



**Figure 11.** Scheme of common rail system.

- Gasoline Direct Injection (GDI): used in gasoline engines, GDI systems inject fuel directly into the combustion chamber, enhancing fuel atomization, control, and combustion efficiency, especially in lean-burn conditions [60]. The 500 bar level represents the target for next-generation GDI systems [61]. The scheme of this system is similar to that of the common rail. Due to the reduced injection pressure levels compared with those of a diesel injection system, the internal architecture of a GDI injector is simpler than that of a diesel injector. Usually, a GDI injector is a solenoid injector without a pilot stage, and the solenoid force is high enough to move up the needle to trigger the injection. A scheme of such injector is reported in Figure 12.



**Figure 12.** Scheme of a GDI injector.

### 3.2.2. Categorization of Approaches

Research in injected mass control can be divided into multiple core methodologies, which are summarized in Table 2 with their primary approaches, strengths, and studies in the field.



**Table 2.** Summary of methodologies in injected mass control.

Methodology	Approach	Strengths	List of References
Direct measurements	Utilization of test benches, Coriolis flow meters, optical diagnostic tools, and high-frequency pressure transducers for real-time data collection	High accuracy with real-time data collection; provides direct, empirical measurements of injection dynamics; supports validation through physical simulations	[22–25,32–34,38,42,48,55,60,62–116]
Model-based estimation	Application of zero-dimensional and one-dimensional computational models (e.g., thermodynamic and hydraulic models) to simulate injection parameters; often validated through test bench data	Cost-effective and adaptable to various conditions; allows for extensive parameter testing with minimal physical resources; applicable in scenarios where direct measurements are infeasible	[26,27,31,36,39,40,44,45,49,53,57,115,117–148]
Machine learning-based approaches	Utilization of supervised and deep learning algorithms to predict injection parameters based on large datasets of historical injection data; neural networks and hybrid algorithms for predictive accuracy	High adaptability to complex, high-dimensional datasets; capable of dynamic, real-time predictive control with minimal need for direct physical measurement; ideal for transient conditions	[28–30,41,43,46,47,149,150]
Hybrid approaches	Combines direct measurement, model-based estimations, and machine learning techniques to harness the strengths of each method, allowing for enhanced flexibility and accuracy in variable conditions	Offers comprehensive analysis through multiple data sources; provides greater adaptability and robustness, particularly under rapidly changing operational conditions	[35,54,91,97,148,151–168]

Table 3, instead, illustrates the distribution of research methodologies in the field. Direct measurements techniques hold the largest share, followed by model-based and hybrid approaches, especially in recent years. This trend highlights the need for reliable and consistent empirical validation methods; however, it also points to the crescent need for cost-effective solutions.

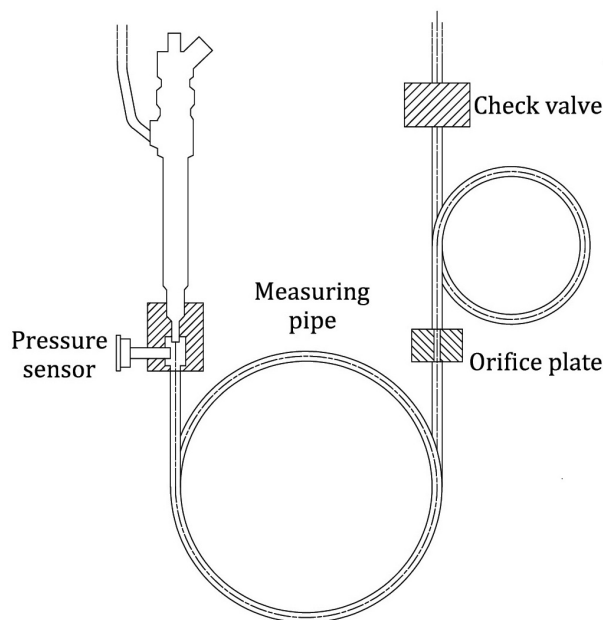
**Table 3.** Distribution of research approaches in injected mass control.

Category	Percentage of Literature
Direct measurements	47.9%
Model-based estimation	28.7%
Machine learning-based approaches	7.6%
Hybrid approach	15.8%

### Direct Measurements

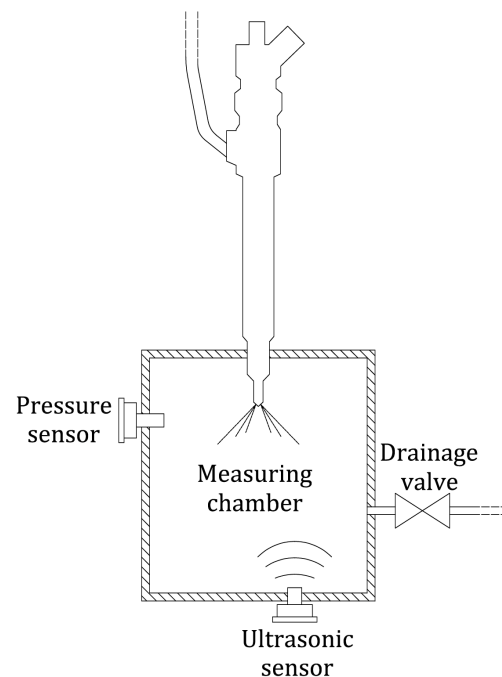
Direct measurement methodologies encompass studies focused on obtaining real-time data regarding injection systems, including parameters such as injection rate, mass flow, spray dynamics, and pressure variations. Direct measurements rely on experimental setups, often involving flowmeters, optical diagnostics, and pressure transducers, to capture the system's performance across various conditions. While these methods offer high accuracy, they can be costly and complex to set up for dynamic engine environments [116,169]. The foundational works about direct measurements widely used to quantify injection

rates and injected fuel mass reveal two different approaches, as explained in [34]. The first is the Bosch method [22], introduced in the mid-20th century, which uses a hydraulic measuring tube to measure fuel injection rate by monitoring the pressure wave propagation triggered by the injection event, as seen in Figure 13. This method is highly accurate, reliable, and repeatable, but it is not applicable to high-speed transient measurements due to the inertia in the liquid column, and the pressure waves can cause signal distortion at high injection pressures.



**Figure 13.** Bosch measurement device.

The second is the Zeuch method [25], which focuses on dynamic measurement using a fuel accumulator and a pressure transducer. This setup, which is shown in Figure 14, allows the pressure changes in the accumulator to be converted directly into injection rate information. The pressure rise in the accumulator, measured by a high-frequency pressure transducer, provides real-time data on the mass flow rate of the fuel being injected. This method provides more immediate measurements, useful for transient and real-time applications, but it is sensitive to initial pressure conditions, requiring calibration, and it has a more complex setup with respect of the previous methodology. Measurements using the Bosch method show slower rising slopes of the injected flow rate, an anomalous tail at the end of injection, and a time-delay in the flow rate trace; while the Zeuch method demonstrates superior accuracy under the conditions tested in the study [170]. These techniques represent the state of the art of injected flow rate test bench measurements; however, since they require that the injector tip is installed in a measuring device (a measuring tube for the Bosch method and an accumulation volume in the Zeuch method), they are not employed for setting up control strategies for on-engine applications, where the injector tip is inserted in the combustion chamber or in the intake manifold.



**Figure 14.** Zeuch approach measurement principle for injected mass.

DENSO technology designed the i-Art system, which has a control chamber in which the pressure is measured via a piezoelectric pressure sensor mounted on the injector pilot stage. In this way, a transfer function of the pressure signal is able to predict the injected mass [80,97]. Delphi, instead, proposed the “Switch” technology. The non-ballistic needle is placed within an electric circuit designed to detect voltage. The needle closes the circuit in two ways: closing the nozzle or reaching the upper stroke limit. In this way, it is possible to detect the voltage at two specific time instants, from which the injected quantity can be estimated using a submodel based on the needle’s lift [94].

Some researchers studied a new flowmeter for monitoring high-pressure, transient flows and validated it through 1D numerical models. It is based on measuring two pressure signals and deriving the mass flow rate through an ordinary differential equation combining continuity and momentum equations. Using this flowmeter could potentially allow researchers to have a feedback control strategy to compensate for inaccuracies in injected mass [42]. In fact, by installing the new flowmeter between the rail and the injector, it is possible to monitor the flowrate and therefore the mass entering the injector during the injection event. Extensive experimental campaigns have verified that the entering mass is strongly correlated to the injected mass (as can be expected based on the continuity equation). Tests performed by means of a rapid prototyping hardware have shown promising results for on-engine applications, since closed-loop control for the injected mass has been set up only based on signals that can be measured both at a hydraulic test bench and at a dynamometer test ring [98,137]. When real-time evaluation of fuel mass injected is concerned, another study proposes to install a single pressure transducer on the pipe that connects the injector to the rail, capturing pressure time histories during the injection process (the set up is similar to those of the Bosch measuring principle). The study found a strong correlation between the estimated fuel flow rates and the measured volumes of fuel during small injections. The derived relationship could be implemented in the engine’s ECU for better control of the injected mass [93]. The precision of injection rate measurements improved both for the piezoelectric injector, as in [86], where a system that integrates advanced signal processing techniques and calibration algorithms can achieve consistent and repeatable measurements across different injection phases; and for solenoid injectors, as in [102], where closely coupled multi-injection strategies are analyzed and critical insights are drawn regarding the influence of these strategies on fuel delivery.

Riemann wave theory was used to enhance accuracy in [110], deriving a mathematical relationship between injection rate and the pressure sensed at the injector inlet to be used in real-time injection rate measurements in common rail systems. Based on Zeuch's method, in the study [32], a built-in device for precisely calibrating the volume elasticity of the fuel is proposed, which would serve for capturing pressure variations and inferring the fuel injection rate. Some researchers focused their attention on Coriolis mass flow meters, to which they applied different signal processing techniques like the prism finite impulse response [104,105,169]. These techniques are used for tracking the vibration modes of the Coriolis flow tube and measure the mass flow rate of individual fuel injections, providing a foundation for potential on-engine real-time application of fuel flow measurements.

Coriolis flow meters, together with tracer-based Laser-Induced Fluorescence (LIF), are a benchmark for their high precision. However, their implementation implies significant costs and limited adaptability in dynamic injection scenarios [17,23,171].

Other devices to be used in test benches, instead, are based on strain gauges which detect the deformation of a membrane in a full Wheatstone bridge configuration. This membrane should deform due to pressure waves generated by the rapid rise of fuel in the measuring space, as seen in [68]. Another takes into account the electric charge generated by liquid droplets as they impact a metal electrode. The electric charge is generated in the nozzle due to the friction between the fuel and the metal parts [65]. When comparing different kind of injectors, ref. [88] takes into account all the factors that the operating conditions (i.e., back pressure, electrical pulse width, injection frequency, fuel pressure) have on different injection strategies. For example, a failure in accounting geometry-induced cavitation in the cylindrical nozzle causes an overestimation of the injection rate of around 9% [103]. Important non-linear behaviors and the relationship between needle lift and ROI are key to optimizing injector performances in [90]. Moreover, the needle dynamics are a key factor in mass flow consistency, as can be seen in [136]. The majority of direct measurement methodologies are applicable only in test benches, such as the ones using laser Doppler vibrometry to measure needle displacement during operation. This is done by pointing a laser beam onto the back surface of the needle through a quartz window, ensuring that fuel pressurization and normal injector operation are maintained [112].

When other fuels are considered, the impacts of fuel properties have been deemed to be of paramount importance. A cost-effective method for injection rate estimation validated for multiple fuels is proposed in ref. [108]. A method for high-precision measurements of transient injection rates of natural gas is proposed in [106] and validated with Schlieren imaging. With momentum and pressure–volume methods, the gas injection rate of a dual-fuel high-pressure direct injection is measured [116]. A study simulating real engine environments analyses the main after injection strategy and the effects that the back pressure and reflected compression waves from the diesel supply system have on the injected mass of gaseous fuel.

While direct measurement methodologies provide invaluable insights into fuel injection dynamics with high accuracy and real-time data collection, they also present challenges in terms of setup complexity, cost, and adaptability to rapidly changing engine conditions, as it is possible to see in Table 4. As the industry continues to demand more flexible and efficient systems, particularly with the rise of alternative fuels, direct measurement techniques serve as a foundational yet increasingly complemented approach, paving the way for hybrid and model-based methods that address the limitations of standalone empirical measurements.

**Table 4.** Comparison of some of the direct measurement techniques.

Technique	Advantages	Limitations
Optical diagnostics	Precise visualization of spray dynamics	Restricted to laboratory settings
Pressure transducers	Real-time data acquisition	Potential sensor degradation
Coriolis flow meters	Accurate mass flow measurements	Expensive, complex installation
Injector waveform analysis	Detailed insights into injector behavior	Requires exact calibration

### Model-Based Estimation

Model-based estimation techniques utilize mathematical models to predict key parameters in fuel injection, such as injection mass, timing, and needle lift. Popular methods include zero-dimensional and one-dimensional models, which are computationally efficient and adaptable to various conditions, though they may struggle with non-linear engine environments. Computational fluid dynamics models provide detailed predictions but are computationally intensive [26,124]. One of the first attempts in this matter is [36], in which the designed system would dynamically adjust the air–fuel ratio (AFR) in SI engines using a mathematical model that estimates the fuel injection quantity based on engine operating conditions. The adaptive system compensates for sensor errors, engine wear, and environmental changes, optimizing fuel delivery in real-time. Ref. [118] offers a closed-loop real-time control solution, adjusting dynamically to operating conditions and improving the fuel efficiency over traditional open-loop systems.

For diesel engines, ref. [117] is among the first to focus on factors such as injection pressure, needle lift, and mass flow rate, with the aim of optimizing the fuel delivery process. The model accounts for the dynamic behavior of the injector, incorporating both hydraulic and mechanical effects within the fuel injection system. The mathematical model provides an accurate estimation of injection parameters, but remains highly theoretical. Refs. [119,172] provides a non-intrusive measurement technique through Time–Frequency (TFA) vibration analysis, combining Wigner–Ville distribution and experimental measurements, but not validating it over a wide range of operating conditions. TFA was applied also in [142] for deriving insights into complex pressure variations for providing high-resolution detection of injections.

Zero-dimensional models [37,40,49,139] offer a lower computational cost, which enables them to run for real-time applications. Moreover, the integration with experimental testing offers a thorough understanding of the problems analyzed.

One-dimensional models were also proposed. For example, in [124], a comprehensive mathematical model was proposed for simulating the dynamics of a common-rail injection system, focusing on the thermofluid dynamics, electromagnetics, and mechanical behaviors of components like rails, connecting pipes, and injectors. The model incorporates one-dimensional flow equations to simulate wave propagation and includes a simple electromagnetic circuit model to predict the solenoid forces. It also addresses fuel compressibility and cavitation effects within the system. Ref. [26] offers a detailed analysis of the hydraulic performance of injectors using biodiesel; a key aspect for adapting modern diesel engines to alternative fuels. Other studies have the same goal of transforming injector design to achieve high control in mass quantity accounting; for example, for fuel temperature, which decreases viscosity, affecting the needle lift and the injector’s response, pressure drops in the control volume and forces due to viscous friction [121,145,155]. Other phenomenological models for predicting the ROI have been studied, e.g., [45], which after calibration offer good predictive capability across a wide range of rail pressure, making it useful for different injection strategies. As far as hydrogen is concerned, there are few studies, and they have not been experimentally validated. It is still worth citing [141], which, through 3D CFD simulations, analyzes the effects of injection pressure and nozzle

diameter on the injected flow rate in hydrogen DI engines, providing some insights on the optimization of hydrogen injection parameters for better efficiencies. While most of the model-based estimations are well-suited to stable operating conditions, they may struggle with the complexities of dynamic injection conditions, as highlighted in Pickl's work on load variations [173]. The accuracies are therefore lower with respect to direct measurements, but with reasonable error margins overall, within 5%. In Table 5 it is possible to find a brief summary of the techniques available for model-based approaches.

**Table 5.** Comparison of model-based estimation techniques.

Technique	Advantages	Limitations
1D/3D CFD models	High accuracy for flow dynamics	Computationally demanding
Zero-dimensional models	Quick calculations for injection rates	Limited to simple geometries or injection strategies
Mathematical algorithms	Adaptable to different fuel types	Requires significant calibration

### Machine Learning-Based Approaches

Machine learning has been used for decades for classifying signals, and it is becoming increasingly relevant in a broad range of topics in science and engineering, including fluid dynamics [29]. Fuel injection control is one of the niches in which this tool has gained momentum, especially considering recent years. The techniques that can be used, including supervised, unsupervised, and deep learning models, are particularly valuable in complex automotive applications where high-density data and intricate system behaviors need to be modeled and predicted. The adaptation to a wide range of situations, such as variations in engine load, fuel type, and operating temperature, is one of the strength of machine learning, which learns and adapts to changing conditions. However, despite these advantages, real-time implementation is still a challenge because it requires a substantial training data set and significant computational resources.

Notwithstanding these obstacles, ongoing research on these methods show promising results in terms of accuracy and robustness. An example of this can be a recent work by Lu et al. [150], which shows that incorporating hybrid learning models enables improved prediction accuracy. In particular, the study uses Generalized Regression Neural Networks (GRNNs) combined with Particle Swarm Optimization (PSO), achieving a mean absolute percentage error of 1.10% and a determination coefficient  $R^2$  of 0.997 on injected fuel quantity. GRNNs have good appeal, as they are a particularly advantageous type of artificial neural network (ANN): they have a simple network structure, with only one hidden layer, and the number of neurons is equal to the number of training samples (which can be a disadvantage because they could be large in size and hence computationally expensive); they are a universal approximation function with just one tuning parameter; they are always able to converge globally without being trapped into local solutions; and they are fast to train, not requiring different iterations but just one pass, which classifies them as a special type of feed-forward ANN. Moreover, it can be easily implemented in widely used programming environments and languages like MATLAB or Python.

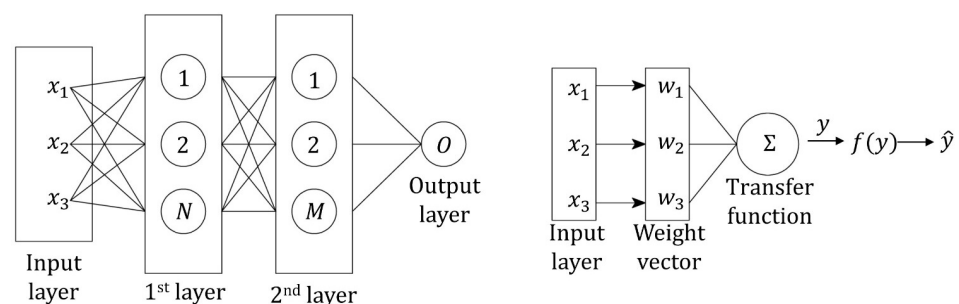
Traditional statistical approaches, including linear regression, could struggle to accurately model the complex interactions between fluid dynamics, injector design, and various operating conditions. In contrast, artificial neural networks (ANNs) in general, but particularly those using a multilayer perceptron (MLP) architecture [149], offer a powerful solution by more effectively modeling nonlinear relationships.

Recent advances [47] have demonstrated the ability of ANNs to effectively predict ROI in GDI systems. These networks are trained using experimental data (4200 entries), allowing them to model the complex relationships among various input factors, including injection pressure, chamber pressure, chamber temperature, and control signal duration. Using

a feed-forward neural network with two hidden layers, optimized with the Levenberg–Marquardt algorithm, the ANN model was able to predict the ROI with a high accuracy. The model demonstrated a high coefficient of determination  $R^2$  of more than 0.99 on various experimental datasets, indicating its ability to generalize well and provide accurate predictions for ROI under different engine operating conditions. In particular, the total injected mass is inferred to exhibit non-linear behavior, which is primarily attributed to the non-linear relationship between the injection duration and pressure. This non-linear trend is attributed to the fact that the effective fuel velocity approaches the theoretical maximum Bernoulli velocity, resulting in the mass flow rate not increasing proportionally with the injection pressure for a given rate of increase. Moreover, the intensity of the ROI oscillations and initial drop in the ROI diminished at lower injection pressures, and finally, the ML model accurately predicted the transient acoustic behavior of the injection.

Other studies, such as [30], apply an integrated ANN code that uses the Bayesian regularization algorithm. Bayesian regularization is a mathematical process that transforms a nonlinear regression into a well-defined statistical problem, similar to ridge regression. This algorithm is known to be more robust than traditional back-propagation methods, reducing the need for a lengthy cross-validation process. For this reason, it is frequently used in engineering problems. An ANN, whose structure is visible in Figure 15, is made up of layers and neurons that constitute the smallest processing element. For each neuron, it is possible to have one or more inputs from outside or from other neurons. These inputs in each neuron are multiplied by a weight and shifted by a bias, providing an intermediate value of the processed variable. Then, this value is transferred through an activation function (linear, Gaussian, ramp, sigmoid, Heaviside) to provide the output of the neuron. In this particular case, the sigmoid activation function is used for both the hidden layers and the linear activation function for the output layer. In this case, a dataset of 570 conditions with 100 injections each was used for training, validating, and testing purposes, and the optimal ratio between the dataset split was 70–20–10%, respectively. A comparison of ROI prediction using the ANN algorithm with experimental results shows that the model is able to predict ROI characteristics not only under quasi-steady-state conditions but also during transient dynamics. The ANN algorithm is able to accurately detect Start of Injection (SOI) and End of Injection (EOI) moments, showing close correspondence with experimental times, regardless of injector pressure difference, coil activation time, fuel temperature, and static flow. It managed to capture detailed features in the ROI and coil voltage signal with four input variables: pressure difference, coil activation time, fuel temperature, and static injector flow. In this way, it is possible to significantly reduce the input information and the computational requirements compared with the CFD approach.

More complex NNs have been used [28], pertaining to the deep learning techniques, using more hidden layers and a longer and iterative learning process. With respect to GRNNs, which are wider, deep learning models make use of Deep Neural Networks (DNNs), allowing for capturing of more complex patterns and connections between data. This comes at the expense of explainability and more abstract and computationally intensive calculations.



**Figure 15.** Schematics of the regression modeling using artificial neural networks.

It is yet apparent that, in order to use these neural networks, which could be implemented on easy-to-use tools (and MATLAB here is the most widespread environment used by engineers in this field), a huge amount of data is required. One potential solution to this challenge could lay in the use of reinforcement learning, which allows systems to learn optimal actions based on feedback from the environment without requiring large data sets, going from data-driven to goal-driven. Reinforcement learning models could be used to continuously optimize fuel injection parameters by learning from real-time data and adapting to new conditions.

In addition, hybrid models that combine machine learning with traditional engineering approaches, as explained in the following section, can provide an effective path to overcome the limitations of current ML models. By combining the strengths of both methods, such models could reduce dependence on large training datasets while maintaining high levels of prediction accuracy and adaptability to different engine conditions. Moreover, hybrid models could improve the interpretability of fuel injection systems, making them more transparent and understandable, avoiding the "black-box" effect of traditional neural networks.

### Hybrid Approaches

Hybrid approaches in injected mass control combine elements from direct measurement, model-based estimation, and machine learning techniques to leverage the strengths of each method. These systems are designed to provide both high precision and adaptability to varying engine conditions, especially under high-pressure and dynamic injection scenarios.

Early works, such as [35], explored indirect sensing techniques for closed-loop diesel fuel quantity control, setting the stage for integrating real-time monitoring with control algorithms. Real-time monitoring has since advanced, as demonstrated in [151], where injector waveforms are tracked to accurately meter fuel and adapt injection timings, enhancing precision under transient conditions.

Subsequent developments in hybrid systems, particularly in solenoid and piezoelectric injectors, have focused on improving the energy efficiency and dynamic response of injectors through innovations in hardware and software. For instance, studies on next-generation solenoid injectors with pressure-balanced pilot valves [153] highlight advancements in both mechanical and electronic control to improve injector responsiveness. Additionally, hybrid approaches address challenges associated with variable injection strategies. Works like [54] analyze different injector types' responses to dwell time variations, optimizing rate shaping for continuous and closely coupled injections. Studies investigating the impact of injector thermal conditions on injection performance [76] further show the importance of hybrid methodologies in adapting injection rates to real-time environmental and operational variations. A hybrid approach for indirectly measuring fuel consumption rates under transient operating conditions was proposed in [158]. This method combines signal measurements with parameter modeling to develop a simplified residual gas fraction model. Unlike the complex three dynamic pressure transducer method, the method utilizing two steady pressure sensors is applied, making it suitable for onboard vehicle applications with errors within 3%.

A unique feature of hybrid systems is their ability to integrate high-fidelity simulations and empirical data, enabling robust injection control. Studies such as [26] employ simulation-driven approaches alongside experimental validation to explore injection dynamics under multi-fuel conditions, enhancing versatility in injector designs. The dual focus on numerical analysis and empirical data also extends to managing injection rate limits under ultra-high pressures [103] and investigating complex interactions within injector nozzles using advanced flow analysis [38]. A recent work [145] introduces feedback-control algorithms that adapt injection parameters based on mass flow fluctuations, optimizing injection processes across varied operational states. Ref. [168] bases its feedback control on two measured pressures, and through the momentum balance and the continuity equation,



it finds the instantaneous flow rate, showing an error reduction in real-time conditions for both single and multiple-injection strategies.

As hybrid methodologies continue to evolve, their applications are broadening to include alternative fuels like biodiesel and GTL (gas-to-liquid) fuels, and studies like [163] explore the injector's response to different fluid properties on the injection process, fuel flow condition, and cavitation in CR systems. In newer studies, advanced control algorithms provide continuous real-time adaptation, making hybrid approaches increasingly integral in next-generation ICEs. By incorporating feedback systems, hybrid methods bridge the gap between model-based precision and empirical validation [166], showing promise in achieving optimal injection control under complex conditions.

### 3.2.3. Micro-Categories

To provide a more detailed perspective on injected mass control, the literature can be divided into three micro-categories: methodology applicability, fuel type, and injector type. Each micro-category provides unique insights into specific approaches, considerations, and adaptations required across different experimental setups, fuel variations, and injector designs.

#### Methodology Applicability

The methodology applicability describes the various approaches to data collection, system monitoring, and analysis of fuel injection. The primary classifications include real-time systems, test bench experiments, and post-processing techniques. An overview of these three classifications is given in Table 6.

- Real-time systems: These systems monitor and adjust fuel injection parameters dynamically during engine operation. Real-time systems allow for immediate feedback and adjustments for optimized fuel delivery under varying conditions, enhancing system responsiveness and adaptability (e.g., [93] and others).
- Test bench experiments: These controlled experimental setups allow for precise measurement of fuel injection parameters, injector dynamics, or spray behavior. By isolating variables, test benches provide high-quality data, which are useful for validating models and refining engine control systems (e.g., [87] and others).
- Post-processing techniques: Data collected during experiments can be analyzed after testing using statistical models or computational techniques to identify trends, verify results, and further develop models. These techniques are valuable in drawing insights from high-fidelity data without the constraints of real-time adjustments (e.g., [128] and others).

**Table 6.** Methodology applicability in injected mass control.

Methodology Type	Description
Real-time systems [27,35,36,41,46,110,118,119,127,131,137,144,145,147,149,151,158,161,162,167,168]	Dynamic adjustments during operation for optimized fuel delivery
Test bench experiments [22–24,28,31–33,62–66,68,70,73–76,78,79,81,84,89,90,96,98,106,120,123,125,138,142,155,166]	Controlled environments for precise data collection on injection dynamics
Post-processing techniques [9,44,50,60,67,70,128,130,148]	Analyzes experimental data post-testing using statistical models

#### Fuel Type

Fuel type significantly influences injection dynamics and emission profiles. The most-investigated fuels are summarized in Table 7. Research varies widely based on fuel, each presenting unique challenges and opportunities in terms of injection control, combustion,

and emissions. Studies in this category often focus on fuel properties and the necessary adjustments of ROI for efficient and clean combustion:

- Diesel: Diesel fuels require high-pressure systems and are often studied for their nozzle cavitation, atomization patterns, and impact on emissions such as NO<sub>x</sub> and soot. Research highlights the need for precise mass control to reduce emissions while maintaining efficiency. Most of the work before the 2010s focused on diesel applications (e.g., [120,123,127] and others), mostly delivered with the CR system. A new common feeding fuel injection system integrating a delivery chamber into the high-pressure pump and eliminating the traditional common rail, thus simplifying the hydraulic circuit, was more recently designed [164].
- Gasoline: Gasoline direct injection (GDI) and port fuel injection are two common approaches. Studies explore air–fuel mixture formation and its effects on combustion efficiency and emissions (e.g., [27,43,50,60,87,88] and others).
- Alternative fuels: Renewable fuels like biodiesel or rapeseed oil introduce unique challenges due to differences in viscosity and spray behavior [26,28,83,108,126,140,165]. They will require nozzle and pressure adaptation to maintain mixing quality and minimize incomplete combustion. Hydrogen or hydrogen–ammonia blends are studied for their GHG emission reduction potential. One aspect to take into consideration is that precise control of the air-to-fuel ratio, in this case, is critical for lowering NO<sub>x</sub> [46,141,174].

It is evident that while the chemical composition of the fuel is relevant, the state of matter undoubtedly has a more significant impact in terms of control strategies. In fact, some of the works (e.g., [157]) analyzed suggest that the fuel type (gasoline, diesel, or biofuels) has no influence on the methodology, although this latter factor has been validated with specific fuel types. In general, however, gaseous fuels require considering that density cannot be assumed to be constant throughout the injection system hydraulic circuit: in this case, the mass conservation equation, the momentum balance equation, and the energy equation, coupled with a state equation, must be taken into account. Concerning liquid fuels, these can be efficiently analyzed only using the continuity equation and the momentum balance equation, together with a thermodynamic state equation for the specific process that the fluid is subjected to [175].

**Table 7.** Fuel types in injected mass control.

Fuel Type	Description
Diesel	High-pressure systems with focus on atomization, NO <sub>x</sub> , and soot emissions
Gasoline	Direct injection (GDI) and port fuel injection; focus on air–fuel mixture
Alternative fuels	Renewable fuels like biodiesel and hydrogen–ammonia blends, emphasizing emission reduction (especially NO <sub>x</sub> )

### Injector Type

The type of injector has a major impact on fuel injection precision, rate, and control. This category focuses on the differences between piezoelectric injectors and solenoid injectors, examining their respective performance and compatibility with advanced fuel control systems. The definitions of these two architectures were already given in Section 3.2.1, and a summary is given in Table 8.

**Table 8.** Injector types in injected mass control.

Injector Type	Description
Piezoelectric injectors [47,83,86,90,95,176]	Fast response and precise control, ideal for high-precision applications
Solenoid injectors [46,79,89,133,137,149,177]	Good control; moderate response time may limit precision at high pressures

#### 4. Discussion

Table 2 summarizes the strengths and key references of the primary methodologies used in fuel injection control, serving as a foundational reference for identifying open research points in this field.

The literature reviewed indicates that direct measurement remains central for accurate fuel mass estimation, because the adaptability of model-based approaches, which have progressed significantly in recent decades, is still weak. Incorporating machine learning techniques enhances this adaptability, especially in the context of different fuel types. Hybrid models that merge the advantages of each approach can lay the foundation for more robust control systems. Concerning machine learning techniques, which are becoming increasingly used, as they have great predictive power, an urgent need exists to make them transparent and interpretable. Their integration into practical applications would benefit from aligning these techniques with a broader physical and scientific framework, allowing their outputs to be more intuitively understood by engineers and researchers.

While considerable progress has been made, some limitations still exist in the control of injected fuel mass. Indeed, although machine learning models are flexible, they require large data sets for training, which can be resource-intensive to gather and process [28]. While zero-dimensional models offer computational efficiency and are grounded in physical equations, their oversimplification limits their applicability in complex, real-world conditions [139], emphasizing the need for models that balance granularity with computational feasibility.

Research into alternative fuels, such as hydrogen, ammonia, and biodiesel, is another area where injected mass control systems must adapt to accommodate distinct combustion characteristics. Foundational studies on this matter [39,178] demonstrate that modifications in common rail systems and injection techniques are necessary to address the unique properties of these fuels. These studies reveal gaps in the flexibility of system designs, particularly for engines that aim to achieve optimal fuel combustion with alternative fuels.

The qualitative analysis aimed at identifying recurring themes, methodological approaches, and gaps in the literature highlighted two main themes: the impact of technological innovation on fuel injection accuracy and the challenges of incorporating alternative fuels into existing injection systems. Recent advancements in real-time injection control, particularly in high-pressure common rail systems and gasoline direct injection (GDI) technologies, underscore the innovation potential. Integrating advanced sensors and feedback systems into injectors facilitates real-time adjustments in fuel quantity, contributing to improved emission control and fuel efficiency thanks to closed-loop control systems.

Despite these advancements, significant research gaps remain, particularly in the optimization of injected mass control for both liquid and gaseous fuels under real-world conditions. Real-time adaptability and precision control of injection mass for gaseous fuels, such as hydrogen [179,180] and CNG [41], present ongoing challenges due to the low density and high compressibility of these fuels, which lead to temperature- and pressure-dependent flow dynamics. These properties necessitate robust, pressure-based control systems that can adjust rapidly to transient engine conditions. Additionally, gaseous fuel injectors must be designed to withstand high flow velocities and pressures, with finely tuned valve actuation and needle lift dynamics to ensure stable delivery [113]. Injector durability, especially under the embrittlement effects of hydrogen at high pressures, adds to these challenges, with concerns over long-term wear of the injector and its precision during the life cycle, as it already does in traditional injection systems [181].

Real-time adaptability remains a research priority, as rapid adjustments in response to fluctuating pressures and temperatures are still underdeveloped, especially in multi-fuel configurations where both gaseous and liquid fuels are used simultaneously [116]. Comprehensive control strategies that accommodate a range of fuel properties and different injection timings must be developed. While initial studies have explored the co-injection of gaseous and liquid fuels, further research is needed to refine these strategies, particularly for improving combustion and minimizing emissions.

Table 9 summarizes these findings across methodologies.

This exploration of advancements in fuel injection technology and methodologies highlights the critical need for further research to overcome limitations, particularly concerning adaptability and integration. Addressing these challenges will facilitate the development of more efficient and sustainable fuel injection systems, paving the way for the broader implementation of alternative fuels.

Future research in fuel injection control systems should prioritize advancements in real-time adaptability and model transparency, especially in machine learning (ML) applications. Integrating ML within control systems has shown significant promise for enhancing adaptability in high-speed and dynamic conditions. Studies [30,50] demonstrate the potential of ML algorithms to improve system adaptability. However, a key challenge persists in making these models interpretable: as ML techniques become more complex, understanding their decision-making processes becomes increasingly difficult, yet this is important for practical application. Thus, future efforts should focus on creating models that balance real-time responsiveness with interpretability. Developing hybrid neural networks that combine the predictive power of ML with the clarity of traditional modeling approaches, as suggested in [28,29], could be a promising path forward.

Enhancing the transparency of ML models is critical for broader application, particularly in contexts where safety and reliability are paramount. Limited interpretability in ML decision-making can hinder the integration of these models into the fuel injection control. Building frameworks that clarify how ML models reach their conclusions will be essential for regulatory compliance and operational acceptance.

**Table 9.** Key findings in injected mass control.

Finding	Implications	Future Research Directions
Need for hybridization of methodologies	Enhances adaptability and robustness	Investigate integration techniques across methodologies
Limitations in real-time data processing	Impacts accuracy under dynamic conditions	Develop efficient algorithms for real-time data integration, find the balance between computation intensity and accuracy
Requirement for extensive training data in ML models	Constrains practical applications	Explore other learning techniques (semi-supervised, PINN)
Complexity of gas dynamics in fuel injection systems	Necessitates specialized approaches for gaseous fuels	Investigate alternative injector designs for precision control

Furthermore, integrating advanced sensor technologies—such as optical and acoustic sensors—alongside ML algorithms offers the potential for improving control accuracy across varied operating conditions [169]. This combination could enable richer data streams, supporting more precise real-time control adjustments and enhancing system performance.

Another pressing area for future research involves adapting injection control systems for alternative fuels, including biodiesel and hydrogen. These fuels present unique challenges due to their distinct chemical and physical properties. Some researchers emphasize the need for optimizing injection strategies to improve emissions control and efficiency

with these fuels [179,180]. Additional studies focused on fuel-specific injection control, providing critical insights into adapting systems for alternative fuels [52,113].

In summary, the evolving landscape of fuel injection control demands hybrid methods that merge machine learning with traditional techniques, enhancing their interpretability, and adapting to the specific characteristics of alternative fuels. Addressing these challenges not only enhances system performance but also supports the automotive industry's transition toward more sustainable fuel sources. Table 10 outlines key findings from current research and highlights gaps that merit further investigation. A full list of papers for each methodology can be found in Table 2.

**Table 10.** Research gaps for each research approach.

Research Approach	State of the Art	Challenges and Gaps
Direct measurements (e.g., [17,23,171,182])	High precision in fuel injection measurement	High cost due to hardware requirements in most cases; high complexity, especially in dynamic conditions; limited generalization possibility; usually hard to employ when the injector is installed on an engine; not always validated for different engine operating conditions.
Model-based estimation (e.g., [26,49,139])	Effective for control systems; cost-effective; adaptable	Limited real-time adaptability; may not capture full dynamics; may require a large amount of data for setup.
Machine learning (e.g., [28,29,92,180])	Predictive, adaptable across various fuel types	High data demands; accuracy depends on the size and quality of the dataset; limited interpretability

#### *Practical Implications and Prospective Solutions*

Hybrid models present a promising avenue for advancing adaptive injection control in internal combustion engines. By combining machine learning with model-based estimations, these control systems achieve the adaptability necessary for diverse operating conditions. This approach enhances system performance while maintaining interpretability; a key element for diagnostics and real-time adjustments. Fuel injection technology's continued evolution necessitates further research to tackle key challenges, particularly in cost-effective real-time measurement, transparency in ML models, and adaptive control tailored for alternative fuels.

One notable barrier to the widespread adoption of ML techniques in injection control is their limited transparency, which complicates real-time diagnostics and system adjustments. Future research should address this by focusing on improving model interpretability, potentially through hybrid approaches that integrate ML with zero-dimensional models. Such methods could retain ML's predictive capabilities while ensuring transparent, understandable decision-making processes, fostering greater trust among users and regulators.

With the automotive industry's shift toward alternative fuels, research on injection control systems for fuels like hydrogen and biodiesel is increasingly critical. However, adapting these systems requires rigorous validation under diverse operating conditions. Existing studies emphasize the need for refined injection control frameworks tailored to the specific properties and combustion characteristics of these fuels. Achieving good injected mass control for alternative fuels remains an ongoing research area, as most current systems are optimized for conventional gasoline and diesel engines. While evidence suggests that CR systems could be adapted for non-traditional fuels, modifications have to be considered to obtain a system with high performance.

Real-time control is a long-standing goal for high-speed engine applications, and advancements in measurement technologies, such as Coriolis flow meters, have made substantial strides in this direction. However, inconsistent integration across different platforms

and the high operational costs associated with these technologies remain obstacles to broader adoption. Increasing demand for real-time responsiveness in control systems underscores the need for further research, especially to embed machine learning models that improve adaptability while addressing interpretability challenges.

In conclusion, this study highlights the importance of hybrid models that utilize direct measurements, model-based estimations, and ML techniques. Future research should focus on overcoming challenges related to transparency, cost-effectiveness, and adaptability across diverse fuel types. By addressing these issues, we can unlock the full potential of advanced fuel injection control technologies, paving the way for more efficient and sustainable engine operations.

## 5. Conclusions

This review provided a comprehensive analysis of the state-of-the-art injected mass control methodologies in ICEs, answering the three primary research questions stated in the Section 2.

*RQ1: What is the state of the art of injected mass control in internal combustion engines?* The analysis revealed a diverse landscape of technologies and methodologies that have evolved to improve the accuracy and efficiency of fuel injection systems. The key approaches identified—direct measurement, model-based estimation, machine learning, and hybrid—each exhibit unique strengths and limitations. Direct measurement techniques offer high accuracy but often involve significant cost and complexity, especially in dynamic settings, making them much more suitable for test benches, although there is some evidence of experimentation for engine applications. Model-based methods, while more cost-effective, both in terms of instrumentation and computation, are suitable for stationary or simpler conditions, and they often encounter difficulties when dealing with transients in engine operation. Machine learning features a potential to adapt to various fuel types, providing predictive capabilities; however, issues such as data dependency and transparency remain significant obstacles to its integration into broader sci-tech frameworks.

*RQ2: How can current approaches to controlling injected mass be classified?* This review has allowed for a classification of methodologies into three main types: direct measurement, model-based estimation, and machine learning. There is also the fourth, increasingly used category of hybrid approaches. This classification provides a structured overview that facilitates a clearer understanding of the field. Moreover, as each category has been analyzed, there is still room for the joint use of these techniques in future research.

*RQ3: What are the future research directions regarding the control of injected mass in ICEs?* The findings suggest that research in the future could focus on two critical areas: improving the interpretability of machine learning models and optimizing control systems for alternative fuels. The development of interpretable machine learning models is crucial to ensure that advanced control technologies can be practically applied in real-world scenarios, where safety, regulatory compliance, and operational reliability are paramount. Hybrid modeling approaches that combine data-driven predictions with physics-based insights seem to be a potential solution to close the gap between complexity and interpretability. Furthermore, now that the automotive industry is moving towards sustainable practices, it is essential to optimize injection strategies for alternative fuels, such as biodiesel and hydrogen. Conventional control systems often struggle to adapt to specific chemical and physical properties of these fuels, causing inconsistencies in performance, especially when switching to gaseous fuels where different control systems are needed to effectively capture the impact of fluid compressibility on the injected mass. Therefore, research may be aimed at the development of advanced control algorithms for different fuel types that would effectively balance emission reduction with performance goals, satisfying both environmental and industrial needs.

In addition to these focal points, the integration of cost-effective real-time measurement technologies will be fundamental to the advancement of fuel injection control systems. Some of the innovations presented, such as the addition of a single pressure sensor to

monitor the amount of mass injected, have the potential to improve the accuracy and reliability of control mechanisms, enabling a wider application of closed-loop controls in the automotive sector, at least for liquid fuels.

However, research should always prioritize the principle of minimum cost–maximum benefit by proposing high-accuracy injected mass control systems that do not require expensive external hardware. Hybrid approaches that leverage machine learning can assist in identifying correlations between various quantities, but efforts should be made to enhance the interpretability of results and their generalizability. By integrating machine learning-based predictive control with advanced sensor integration, manufacturers can substantially enhance the accuracy of fuel injection timing and quantity, resulting in measurable improvements in fuel efficiency across diverse engine platforms. Implementing specific injection strategies tailored to alternative fuels, such as those optimized for biodiesel, hydrogen, or ammonia blends, enables the reduction of NO<sub>x</sub> and particulate emissions while complying with stringent regional emission standards.

These results hold particular relevance for hybrid powertrains, as precise fuel injection ensures a seamless transition between ICE and electric operation, abating fuel consumption.

Future research should explore injection technologies that dynamically adapt to alternative fuels, addressing challenges such as the varying viscosity of biofuels or the flame speed of hydrogen. Collaborative efforts between academia, industry, and policymakers can establish standardized methodologies for machine learning-based control and compatibility with alternative fuels, accelerating their real-world deployment. Supportive regulations and incentives can drive the adoption of cleaner injection technologies, particularly in markets with stringent emission targets.

In conclusion, this review underlines the central role that injected mass control has in improving engine performance, reducing emissions, and meeting European and global regulatory standards. As the automotive industry accelerates toward sustainable practices, the transformational potential of advanced methodologies is evident, and ongoing research must continue to fill the gaps that have been highlighted so far. Improving the understanding and control of fuel injection systems may bring about a step towards the realization of sustainable, responsible, and high-performance automotive technologies that are capable of meeting the challenges of the eclectic mobility of the future.

**Author Contributions:** Conceptualization, A.F. and O.V.; methodology, S.G.; data curation, S.G.; writing—original draft preparation, S.G. and O.V.; writing—review and editing, O.V., S.G. and A.F.; supervision, A.F.; All authors have read and agreed to the published version of the manuscript.

**Funding:** This research received no external funding.

**Data Availability Statement:** No new data were created in this study. The data supporting the findings of this systematic review are derived from published studies, which are cited within this article.

**Conflicts of Interest:** The authors declare no conflicts of interest.

## References

1. European Commission. Roadmap to a Single European Transport Area—Towards a Competitive and Resource Efficient Transport System; White Paper. COM/2011/0144 Final. 2011. Available online: <https://eur-lex.europa.eu/LexUriServ/LexUriServ.do?uri=COM:2011:0144:FIN:EN:PDF> (accessed on 30 October 2024).
2. United Nations Framework Convention on Climate Change. Kyoto Protocol to the United Nations Framework Convention on Climate Change. Treaty. 1997; Adopted on 11 December 1997, Entered into Force on 16 February 2005. Available online: <https://unfccc.int/sites/default/files/resource/docs/cop3/107a01.pdf> (accessed on 19 October 2024).
3. International Council on Clean Transportation. European Vehicle Market Statistics Pocketbook; Technical Report, ICCT. 2023. Available online: <https://theicct.org/publication/european-vehicle-market-statistics-2023-24/> (accessed on 18 October 2024).
4. Mohan, B.; Yang, W.; Chou, S.K. Fuel injection strategies for performance improvement and emissions reduction in compression ignition engines—A review. *Renew. Sustain. Energy Rev.* **2013**, *28*, 664–676. [CrossRef]
5. European Automobile Manufacturers' Association. New Car Registrations, European Union; Technical Report, ACEA. 2024. Available online: <https://www.acea.auto/figure/fuel-types-of-new-passenger-cars-in-eu/> (accessed on 12 October 2024).

6. European Parliament and European Council. Regulation—2019/631; 2019. Available online: <https://data.europa.eu/eli/reg/2019/631/2024-01-01> (accessed on 24 October 2024).
7. European Commission and Directorate-General for Internal Market, Industry, Entrepreneurship and SMEs; Ntziachristos, L.; Papadopoulos, G.; Samos, Z.; Tsalikidis, N.; Mellios, G.; Dimaratos, A.; Kontses, A.; Kontses, D.; Samaras, Z. *Euro 7 Impact Assessment Study*; Publications Office of the European Union: Luxembourg, 2022. [CrossRef]
8. European Parliament and European Council. Regulation—2017/1151; 2017. Available online: <https://data.europa.eu/eli/reg/2017/1151/2023-09-01> (accessed on 24 October 2024).
9. Hammer, J.; Raff, M.; Naber, D. Advanced diesel fuel injection equipment—A never ending BOSCH story. In Proceedings of the 14. Internationales Stuttgarter Symposium: Automobil-und Motorentechnik; Springer: Wiesbaden, Germany, 2014; pp. 31–45. [CrossRef]
10. Heywood, J.B. *Internal Combustion Engine Fundamentals*; McGraw-Hill: New York, NY, USA, 1988.
11. Alagumalai, A. Internal combustion engines: Progress and prospects. *Renew. Sustain. Energy Rev.* **2014**, *38*, 561–571. [CrossRef]
12. Pham, P.; Vo, D.; Jazar, R. Development of fuel metering techniques for spark ignition engines. *Fuel* **2017**, *206*, 701–715. [CrossRef]
13. Kuznetsov, G.; Dorokhov, V.; Vershinina, K.; Kerimbekova, S.; Romanov, D.; Kartashova, K. Composite Liquid Biofuels for Power Plants and Engines: Review. *Energies* **2023**, *16*, 5939. [CrossRef]
14. Guo, S.; Liu, J.; Zhao, C.; Wang, L.; Yang, Z. Research on pre-ignition in hydrogen internal combustion engines based on characteristic parameters of hot spot. *Int. J. Hydrogen Energy* **2024**, *65*, 548–554. [CrossRef]
15. Mata, C.; Rojas-Reinoso, V.; Soriano, J.A. Experimental determination and modelling of fuel rate of injection: A review. *Fuel* **2023**, *343*, 127895. [CrossRef]
16. Gandhi, A.H.; Meinhart, M.; Ortiz, S. *Summary of Flow Metering Options for Injector Characterization*; SAE Technical Papers; SAE International: Warrendale, PA, USA, 2009. [CrossRef]
17. Wang, T.; Baker, R.C. Coriolis flowmeters: A review of developments over the past 20 years, and an assessment of the state of the art and likely future directions. *Flow Meas. Instrum.* **2014**, *40*, 99–123. [CrossRef]
18. Fansler, T.D.; Parrish, S.E. Spray measurement technology: A review. *Meas. Sci. Technol.* **2015**, *26*, 012002. [CrossRef]
19. Schmidt, D.; Corradini, M. The internal flow of diesel fuel injector nozzles: A review. *Int. J. Engine Res.* **2001**, *2*, 1–22. [CrossRef]
20. Jesson, J.; Lacey, F.M.; Matheson, L. *Doing Your Literature Review: Traditional and Systematic Techniques*; Sage: Los Angeles, CA, USA, 2011.
21. Page, M.J.; Moher, D.; Bossuyt, P.M.; Boutron, I.; Hoffmann, T.C.; Mulrow, C.D.; Shamseer, L.; Tetzlaff, J.M.; Akl, E.A.; Brennan, S.E.; et al. PRISMA 2020 explanation and elaboration: Updated guidance and exemplars for reporting systematic reviews. *BMJ* **2021**, *372*, n160. [CrossRef]
22. Bosch, W. The Fuel Rate Indicator: A New Measuring Instrument For Display of the Characteristics of Individual Injection. *SAE Trans.* **1966**, *75*, 641–662. [CrossRef]
23. Wehrman, R.; Mitchell, H.; Turunen, W. Measuring Rate of Fuel Injection in an Operating Diesel Engine. *SAE Trans.* **1953**, *61*, 542–556. [CrossRef]
24. Matsuoka, S.; Yokota, K.; Kamimoto, T. The Measurement of Injection Rate. *Proc. Inst. Mech. Eng.* **1969**, *184*, 87–94. [CrossRef]
25. Zeuch, W. Neue verfahren zur messung des einspritzgesetzes und der einspritz-regelmäßigkeit von diesel-einspritzpumpen. *MTZ* **1961**, *22*, 415–420.
26. Salvador, F.J.; Gimeno, J.; De la Morena, J.; Carreres, M. Using one-dimensional modeling to analyze the influence of the use of biodiesels on the dynamic behavior of solenoid-operated injectors in common rail systems: Results of the simulations and discussion. *Energy Convers. Manag.* **2012**, *54*, 122–132. [CrossRef]
27. Scafati, F.T.; Pirozzi, F.; Cannavacciuolo, S.; Allocca, L.; Montanaro, A. *Real Time Control of GDI Fuel Injection During Ballistic Operation Mode*; SAE Technical Papers; SAE International: Warrendale, PA, USA, 2015. [CrossRef]
28. Vignesh, R.; Ashok, B. Deep neural network model-based global calibration scheme for split injection control map to enhance the characteristics of biofuel powered engine. *Energy Convers. Manag.* **2021**, *249*, 114875. [CrossRef]
29. Terzic, E.; Terzic, J.; Nagarajah, R.; Alamgir, M. A neural network approach to fluid quantity measurement in dynamic environments. *Mechatronics* **2011**, *21*, 145–155. [CrossRef]
30. Oh, H.; Hwang, J.; Pickett, L.M.; Han, D. Machine-learning based prediction of injection rate and solenoid voltage characteristics in GDI injectors. *Fuel* **2021**, *311*, 122569. [CrossRef]
31. Becchi, G.A. Analytical Simulation of Fuel Injection in Diesel Engines. *SAE Trans.* **1971**, *80*, 1825–1869. [CrossRef]
32. Takamura, A.; Fukushima, S.; Yukimitsu, O.; Kamimoto, T. Development of a New Measurement Tool for Fuel Injection Rate in Diesel Engines. *SAE Trans.* **1989**, *98*, 409–414. [CrossRef]
33. Marčić, M. *Measuring the Injection Rate in Diesel Multi-Hole Nozzles*; SAE Technical Papers; SAE International: Warrendale, PA, USA, 1990. [CrossRef]
34. Bower, G.R.; Foster, D.E. *A Comparison of the Bosch and Zuech Rate of Injection Meters*; SAE Technical Papers; SAE International: Warrendale, PA, USA, 1991. [CrossRef]
35. MacCarley, C.A.; Clark, W.D.; Nakae, K.T. An indirect sensing technique for closed-loop diesel fuel quantity control. *SAE Trans.* **1990**, *99*, 188–196. [CrossRef]
36. Turin, R.; Geering, H. Model-Based Adaptive Fuel Control in an SI Engine. *SAE Trans.* **1994**, *103*, 452–461. [CrossRef]



37. Baratta, M.; Catania, A.; Ferrari, A. Hydraulic Circuit Design Rules to Remove the Dependence of the Injected Fuel Amount on Dwell Time in Multijet CR Systems. *J. Fluids Eng.* **2008**, *130*, 121104. [[CrossRef](#)]
38. Catania, A.; Ferrari, A. Development and assessment of a new operating principle for the measurement of unsteady flow rates in high-pressure pipelines. *Flow Meas. Instrum.* **2009**, *20*, 230–240. [[CrossRef](#)]
39. Yan, F.; Wang, J. Common rail injection system on-line parameter calibration for precise injection quantity control. In Proceedings of the 2010 American Control Conference, Baltimore, MD, USA, 30 June–2 July 2010. [[CrossRef](#)]
40. Payri, R.; Gimeno, J.; Novella, R.; Bracho, G. On the rate of injection modeling applied to direct injection compression ignition engines. *Int. J. Engine Res.* **2016**, *17*, 1015–1030. [[CrossRef](#)]
41. Yang, X.; Dong, Q.; Wang, X.; Wei, D. Hybrid data-driven and mechanism-modeling approaches for online injection rate sensing of dual-fuel co-direct injector under carbon neutral background. *Fuel* **2024**, *358*, 130229. [[CrossRef](#)]
42. Ferrari, A.; Pizzo, P.; Vento, O. Investigation of a GDI injector with an innovative flowmeter for high-pressure transient flows. *Int. J. Engine Res.* **2023**, *24*, 4287–4296. [[CrossRef](#)]
43. Khan, S.; Masood, M.; Medina, M.A.; Alzaharani, F. Advancing Fuel Spray Characterization: A Machine Learning Approach for Directly Injected Gasoline Fuel Sprays. *Fuel* **2024**, *371*, 131980. [[CrossRef](#)]
44. Ferrari, A.; Pizzo, P. Fully predictive Common Rail fuel injection apparatus model and its application to global system dynamics analyses. *Int. J. Engine Res.* **2017**, *18*, 273–290. [[CrossRef](#)]
45. Perini, F.; Busch, S.; Reitz, R. A phenomenological rate of injection model for predicting fuel injection with application to mixture formation in light-duty diesel engines. *Proc. Inst. Mech. Eng. Part D J. Automob. Eng.* **2020**, *234*, 1826–1839. [[CrossRef](#)]
46. Yang, X.; Yang, F.; Li, N.; Zhang, L.; Lei, J.; Shi, C.; Bai, Y.; Dong, Q. Study on prediction of gas injection mass fluctuation for hydrogen-diesel co-direct injection system: A prediction algorithm driven by model and perception iterative. *Energy* **2024**, *308*, 133002. [[CrossRef](#)]
47. Choi, E.S.; Park, J.; Hwang, J.; Oh, H.; Manin, J.; Sim, H.S. Injection Rate Measurements and Machine-Learning Based Predictions of Ecn spray-A3 Piezoelectric Injector. *Appl. Therm. Eng.* **2024**, *254*, 123827. [[CrossRef](#)]
48. da Silva, E.A.; Baêta, J.; Fonseca, R.A.; Malaquias, A.C.T.; Ferreira, A.G.; Maia, A.A.T. Non-invasive fuel consumption measurement for internal combustion engines based on Otto cycle. *J. Braz. Soc. Mech. Sci. Eng.* **2023**, *45*, 627. [[CrossRef](#)]
49. Rojas-Reinoso, V.; Mata, C.; Soriano, J.A.; Armas, O. Zero-Dimensional Modeling of the Rate of Injection with a Diesel Common Rail System Using Single-Hole Nozzles with Neat Low-Carbon Fuels. *Appl. Sci.* **2024**, *14*, 2446. [[CrossRef](#)]
50. Payri, R.; Bracho, G.; Gimeno, J.; Bautista, A. Rate of injection modelling for gasoline direct injectors. *Energy Convers. Manag.* **2018**, *166*, 424–432. [[CrossRef](#)]
51. Tetrault, P.; Seers, P. A rate-of-injection model for predicting single and double injection with or without fusion. *Int. J. Engine Res.* **2023**, *24*, 3613–3625. [[CrossRef](#)] [[PubMed](#)]
52. Lu, X.; Han, D.; Huang, Z. Fuel design and management for the control of advanced compression-ignition combustion modes. *Prog. Energy Combust. Sci.* **2011**, *37*, 741–783. [[CrossRef](#)]
53. Finesso, R.; Spessa, E. A control-oriented approach to estimate the injected fuel mass on the basis of the measured in-cylinder pressure in multiple injection diesel engines. *Energy Convers. Manag.* **2015**, *105*, 54–70. [[CrossRef](#)]
54. Ferrari, A.; Zhang, T. Influence of the injector setup on digital and continuous injection rate-shaping performance in diesel engine passenger cars. *Energy Convers. Manag.* **2020**, *205*, 112259. [[CrossRef](#)]
55. D’Ambrosio, S.; Ferrari, A. Diesel engines equipped with piezoelectric and solenoid injectors: Hydraulic performance of the injectors and comparison of the emissions, noise and fuel consumption. *Appl. Energy* **2018**, *211*, 1324–1342. [[CrossRef](#)]
56. D’Ambrosio, S.; Ferrari, A. Boot injection dynamics and parametrical analysis of boot shaped injections in low-temperature combustion diesel engines for the optimization of pollutant emissions and combustion noise. *Energy* **2017**, *134*, 420–437. [[CrossRef](#)]
57. Yan, F.; Wang, J. Common rail injection system iterative learning control based parameter calibration for accurate fuel injection quantity control. *Int. J. Automot. Technol.* **2011**, *12*, 149–157. [[CrossRef](#)]
58. Payri, R.; Gimeno, J.; Cuisano, J.; Arco, J. Hydraulic Characterization of Diesel Engine Single-Hole Injectors. *Fuel* **2016**, *180*, 357–366. [[CrossRef](#)]
59. Zhai, C.; Jin, Y.; Feng, Z.; Chang, F.; Luo, H.; Nishida, K.; Ogata, Y. Characterization of diesel spray combustion under micro-hole and ultra-high injection pressure conditions—analyses of diffused back-illumination imaging and OH\* chemiluminescence imaging. *Fuel Process. Technol.* **2023**, *252*, 107955. [[CrossRef](#)]
60. Hung, D.; Harrington, D.; Gandhi, A.; Markle, L.E.; Parrish, S.; Shakal, J.; Sayar, H.; Cummings, S.D.; Kramer, J. *Gasoline Fuel Injector Spray Measurement and Characterization—A New SAE J2715 Recommended Practice*; SAE Technical Papers; SAE International: Warrendale, PA, USA, 2008. [[CrossRef](#)]
61. Li, X.; Li, D.; Liu, J.; Ajmal, T.; Aitouche, A.; Mobasheri, R.; Rybdylova, O.; Pei, Y.; Peng, Z. Comparative Study on the Macroscopic Characteristics of Gasoline and Ethanol Spray from a GDI Injector under Injection Pressures of 10 and 60 MPa. *ACS Omega* **2022**, *7*, 8864–8873. [[CrossRef](#)] [[PubMed](#)]
62. Takamura, A.; Ohta, T.; Fukushima, S.; Kamimoto, T. *A Study on Precise Measurement of Diesel Fuel Injection Rate*; SAE Technical Papers; SAE International: Warrendale, PA, USA, 1992. [[CrossRef](#)]
63. Arcoumanis, C.; Baniasad, M.S. *Analysis of Consecutive Fuel Injection Rate Signals Obtained by the Zeuch and Bosch Methods*; SAE Technical Papers; SAE International: Warrendale, PA, USA, 1993. [[CrossRef](#)]

64. Desantes, J.; Arrègle, J.; Pastor, J.; Delage, A. *Influence of the Fuel Characteristics on the Injection Process in a D.I. Diesel Engine*; SAE Technical Papers; SAE International: Warrendale, PA, USA, 1998. [[CrossRef](#)]
65. Marcic, M. A new method for measuring fuel-injection rate. *Flow Meas. Instrum.* **1999**, *10*, 159–165. [[CrossRef](#)]
66. Marčič, M. New diesel injection nozzle flow measuring device. *Rev. Sci. Instrum.* **2000**, *71*, 1876–1882. [[CrossRef](#)]
67. Henry, M.; Clarke, D.; Archer, N.; Bowles, J.; Leahy, M.J.; Liu, R.; Vignos, J.; Zhou, F. A self-validating digital Coriolis mass-flow meter: An overview. *Control Eng. Pract.* **2000**, *8*, 487–506. [[CrossRef](#)]
68. Marcic, M. Measuring method for diesel multihole injection nozzles. *Sens. Actuators A-Phys.* **2003**, *107*, 152–158. [[CrossRef](#)]
69. Desantes, J.M.; Benajes, J.; Molina, S.; González, C. The modification of the fuel injection rate in heavy-duty diesel engines. Part 1: Effects on engine performance and emissions. *Appl. Therm. Eng.* **2004**, *24*, 2701–2714. [[CrossRef](#)]
70. Payri, R.; García, J.M.; Salvador, F.J.; Gimeno, J. Using spray momentum flux measurements to understand the influence of diesel nozzle geometry on spray characteristics. *Fuel* **2005**, *84*, 551–561. [[CrossRef](#)]
71. Payri, F.; Luján, J.M.; Guardiola, C.; Rizzoni, G. Injection diagnosis through common-rail pressure measurement. *Proc. Inst. Mech. Eng. Part D J. Automob. Eng.* **2006**, *220*, 347–357. [[CrossRef](#)]
72. Schmid, U.; Krötz, G.; Schmitt-Landsiedel, D. A volumetric flow sensor for automotive injection systems. *J. Micromech. Microeng.* **2008**, *8*, 045006. [[CrossRef](#)]
73. Payri, R.; Salvador, F.J.; Gimeno, J.; Bracho, G. A new methodology for correcting the signal cumulative phenomenon on injection rate measurements. *Exp. Tech.* **2008**, *32*, 46. [[CrossRef](#)]
74. Ramírez, A.I.; Som, S.; Aggarwal, S.K.; Kastengren, A.L.; El-Hannouny, E.; Longman, D.E.; Powell, C.F. Quantitative X-ray measurements of high-pressure fuel sprays from a production heavy duty diesel injector. *Exp. Fluids* **2009**, *47*, 119–134. [[CrossRef](#)]
75. Payri, R.; Salvador, F.J.; Gimeno, J.; De la Morena, J. Influence of injector technology on injection and combustion development, Part 1: Hydraulic characterization. *Appl. Energy* **2011**, *88*, 1068–1074. [[CrossRef](#)]
76. Albarbar, A.; Gu, F.; Ball, A. Diesel engine fuel injection monitoring using acoustic measurements and independent component analysis. *Measurement* **2010**, *43*, 1376–1386. [[CrossRef](#)]
77. Dernotte, J.; Hespel, C.; Foucher, F.; Houille, S.; Mounaïm-Rousselle, C. Influence of physical fuel properties on the injection rate in a Diesel injector. *Fuel* **2012**, *96*, 153–160. [[CrossRef](#)]
78. Payri, R.; García, A.; Domenech, V.; Durrett, R.P.; Plazas, A.H. An experimental study of gasoline effects on injection rate, momentum flux and spray characteristics using a common rail diesel injection system. *Fuel* **2012**, *97*, 390–399. [[CrossRef](#)]
79. Johnson, S.E.; Nesbitt, J.E.; Naber, J. Mass and Momentum Flux Measurements with a High Pressure Common Rail Diesel Fuel Injector. In Proceedings of the Internal Combustion Engine Division Fall Technical Conference, San Antonio, TX, USA, 12–15 September 2010. [[CrossRef](#)]
80. Ishiduka, K.; Uchiyama, K.; Higuchi, K.; Yamada, N.; Takeuchi, K.; Herrmann, O. Further innovations for diesel fuel injection systems: Close-loop control of fuel quantity by i-Art & ultra-high injection pressure. In Proceedings of the 19th Aachen Colloquium, Aachen, Germany, 4–6 October 2010.
81. Herfatmanesh, M.R.; Lu, P.; Attar, M.A.; Zhao, H. Experimental investigation into the effects of two-stage injection on fuel injection quantity, combustion and emissions in a high-speed optical common rail diesel engine. *Fuel* **2013**, *109*, 137–147. [[CrossRef](#)]
82. Luo, F.; Cui, H.; Dong, S. Transient measuring method for injection rate of each nozzle hole based on spray momentum flux. *Fuel* **2014**, *125*, 20–29. [[CrossRef](#)]
83. Tinprabath, P.; Hespel, C.; Chanchaona, S.; Foucher, F. Influence of biodiesel and diesel fuel blends on the injection rate under cold conditions. *Fuel* **2015**, *144*, 80–89. [[CrossRef](#)]
84. Postriotti, L.; Buitoni, G.; Pesce, F.C.; Ciaravino, C. Zeuch method-based injection rate analysis of a common-rail system operated with advanced injection strategies. *Fuel* **2014**, *128*, 188–198. [[CrossRef](#)]
85. Crua, C.; Heikal, M. Time-resolved fuel injector flow characterisation based on 3D laser Doppler vibrometry. *Meas. Sci. Technol.* **2015**, *25*, 125301. [[CrossRef](#)]
86. Teruo, Y.; Kentaro, W.; Takashi, K.; Motohiro, S.; Ishikawa, S. *Development of Highly Precise Injection-Rate Detector Applicable to Piezoelectric Injectors Having the Function of Ultra Multi-Stage Injection*; SAE Technical Papers; SAE International: Warrendale, PA, USA, 2015. [[CrossRef](#)]
87. Payri, R.; Gimeno, J.; Martí-Aldaraví, P.; Vaquerizo, D. *Momentum Flux Measurements on an ECU GDI Injector*; SAE Technical Papers; SAE International: Warrendale, PA, USA, 2015. [[CrossRef](#)]
88. Dahlander, P.; Iemmolo, D.; Tong, Y. *Measurements of Time-Resolved Mass Injection Rates for a Multi-Hole and an Outward Opening Piezo GDI Injector*; SAE Technical Papers; SAE International: Warrendale, PA, USA, 2015. [[CrossRef](#)]
89. Busch, S.; Miles, P.C. Parametric Study of Injection Rates with Solenoid Injectors in an Injection Quantity and Rate Measuring Device. *J. Eng. Gas Turbines Power* **2015**, *137*, 101503. [[CrossRef](#)]
90. Viera, J.P.; Payri, R.; Swantek, A.B.; Duke, D.J.; Sovis, N.; Kastengren, A.L.; Powell, C.F. Linking instantaneous rate of injection to X-ray needle lift measurements for a direct-acting piezoelectric injector. *Energy Convers. Manag.* **2016**, *112*, 350–358. [[CrossRef](#)]
91. Ferrari, A.; Mittica, A.; Paolicelli, F.; Pizzo, P. Hydraulic Characterization of Solenoid-actuated Injectors for Diesel Engine Common Rail Systems. *Energy Procedia* **2016**, *101*, 878–885. [[CrossRef](#)]
92. Luo, F.; Jiang, S.; Moro, A.; Luo, T.; Zhou, L.; Wu, X. The development of a data acquisition system for measuring the injection rate of a multihole diesel injector. *Sens. Actuators A-Phys.* **2017**, *261*, 166–176. [[CrossRef](#)]

93. Ferrari, A.; Paolicelli, F. An indirect method for the real-time evaluation of the fuel mass injected in small injections in Common Rail diesel engines. *Fuel* **2017**, *191*, 322–329. [[CrossRef](#)]
94. Voigt, P.; Schiffigens, H.J.; Daveau, C.; Oge, J.C.; Beduneau, J.L.; Meissonier, G.; Tapin, C.; Lale, X. Delphi Injector Closed Loop Control Strategy Using the “Switch” Technology for Diesel Passenger Cars—Injector Hardware. In Proceedings of the 10. Tagung Diesel- und Benzindirekteinspritzung 2016—Proceedings; Springer: Wiesbaden, Germany, 2017. [[CrossRef](#)]
95. Payri, R.; Gimeno, J.; Mata, C.; Viera, A. Rate of injection measurements of a direct-acting piezoelectric injector for different operating temperatures. *Energy Convers. Manag.* **2017**, *112*, 350–358. [[CrossRef](#)]
96. Leach, F.; Karout, S.; Zhou, F.; Tombs, M.; Davy, M.H.; Henry, M. Fast Coriolis mass flow metering for monitoring diesel fuel injection. *Flow Meas. Instrum.* **2017**, *58*, 1–5. [[CrossRef](#)]
97. Serizawa, K.; Ueda, D.; Mikami, N.; Tomida, Y.; Weber, J. *Realizing Robust Combustion with High Response Diesel Injector with Controlled Diffusive Spray Nozzle and Closed Loop Injection Control*; SAE Technical Papers; SAE International: Warrendale, PA, USA, 2017. [[CrossRef](#)]
98. Ferrari, A.; Novara, C.; Paolucci, E.; Vento, O.; Violante, M.; Zhang, T. Design and rapid prototyping of a closed-loop control strategy of the injected mass for the reduction of CO<sub>2</sub>, combustion noise and pollutant emissions in diesel engines. *Appl. Energy* **2018**, *232*, 358–367. [[CrossRef](#)]
99. Szpica, D. Investigating fuel dosage non-repeatability of low-pressure gas-phase injectors. *Flow Meas. Instrum.* **2018**, *59*, 147–156. [[CrossRef](#)]
100. Leach, F.; Davy, M.H.; Henry, M.; Tombs, M.; Zhou, F. A New Method for Measuring Fuel Flow in an Individual Injection in Real Time. *SAE Int. J. Engines* **2018**, *11*, 687–696. [[CrossRef](#)]
101. Wang, B.; Du, Y.; Xu, N. Simulation and experimental verification on dynamic calibration of fuel gear flowmeters. *Measurement* **2019**, *138*, 570–577. [[CrossRef](#)]
102. Cavicchi, A.; Postriotti, L.; Scarponi, E. Hydraulic analysis of a GDI injector operation with close multi-injection strategies. *Fuel* **2019**, *235*, 1114–1122. [[CrossRef](#)]
103. Du, C.; Andersson, S.B.; Andersson, M. The effect of cavitation on the estimation of fuel injection rates based on momentum flux measurements. *Fuel* **2019**, *238*, 354–362. [[CrossRef](#)]
104. Henry, M.; Zhou, F.; Tombs, M.; Leach, F.; Davy, M.H.; Malladi, M.R. Prism Signal Processing of Coriolis meter data for gasoline fuel injection monitoring. *Flow Meas. Instrum.* **2019**, *70*, 101645. [[CrossRef](#)]
105. Leach, F.; Davy, M.; Henry, M.; Malladi, M.R.; Tombs, M.; Zhou, F.; Gold, M.; Pearson, R. *Fast NGC: A New On-Line Technique for Fuel Flow Measurement*; SAE Technical Paper Series; SAE International: Warrendale, PA, USA, 2019. [[CrossRef](#)]
106. Dong, Q.; Yang, X.; Jia, D.; Song, E.; Yao, C. Measurement and verification of transient injection flow rate of high pressure natural gas pulse injector. *Flow Meas. Instrum.* **2020**, *76*, 101831. [[CrossRef](#)]
107. Miller, M.; Kuhnhenh, M.; Samerski, I.; Lamanna, G.; Weigand, B. *Evaluation of Geometry-Dependent Spray Hole Individual Mass Flow Rates of Multi-Hole High-Pressure GDI-Injectors Utilizing a Novel Measurement Setup*; SAE Technical Papers; SAE International: Warrendale, PA, USA, 2020. [[CrossRef](#)]
108. Payri, R.; Bracho, G.; Soriano, J.A.; Fernández-Yáñez, P.; Armas, O. Nozzle rate of injection estimation from hole to hole momentum flux data with different fossil and renewable fuels. *Fuel* **2020**, *279*, 118404. [[CrossRef](#)]
109. Payri, R.; Gimeno, J.; Martí-Aldaraví, P.; Viera, A. Measurements of the mass allocation for multiple injection strategies using the rate of injection and momentum flux signals. *Int. J. Engine Res.* **2021**, *22*, 1180–1195. [[CrossRef](#)]
110. Dong, Q.; Yang, X.; Ni, H.; Song, J.; Lu, C.; Ni, Z. An on-line measurement method of injection rate of high pressure common rail system. *Measurement* **2021**, *170*, 108716. [[CrossRef](#)]
111. Vass, S.; Zöldy, M. Effects of boundary conditions on a Bosch-type injection rate meter. *Transport* **2021**, *36*, 297–304. [[CrossRef](#)]
112. Cavicchi, A.; Postriotti, L. Simultaneous needle lift and injection rate measurement for GDI fuel injectors by laser Doppler vibrometry and Zeuch method. *Fuel* **2021**, *285*, 119021. [[CrossRef](#)]
113. Raheem, A.; Siddiqi, A.S.B.; Ibrahim, A.; Ullah, A.; Inayat, M.H. Evaluation of multi-holed orifice flowmeters under developing flow conditions—An experimental study. *Flow Meas. Instrum.* **2021**, *79*, 101894. [[CrossRef](#)]
114. Li, Z.; Mi, S.; Zhang, Y.; Qian, Y.; Lu, X. Characterizing the role of fuel injection strategies on performance, combustion, and emissions in intelligent charge compression ignition (ICCI) mode. *Appl. Therm. Eng.* **2022**, *207*, 118169. [[CrossRef](#)]
115. Yang, X.; Wang, X.; Dong, Q.; Wei, D.; Zhou, T. A measurement method for the dual fuel coupling injection characteristics of the high-pressure natural gas and diesel co-direct injection engine. *Measurement* **2022**, *193*, 110891. [[CrossRef](#)]
116. Wei, D.; Dong, Q.; Ju, C.; Wang, X.; Yang, X. Simultaneous measurement and analysis of gas needle lift and injected rate for HPDI fuel injector. *Measurement* **2024**, *231*, 114493. [[CrossRef](#)]
117. Marčič, M. *Calculation of the Diesel Fuel Injection Parameters*; SAE Technical Papers; SAE International: Warrendale, PA, USA, 1995. [[CrossRef](#)]
118. Nasu, M.; Ohata, A.; Abe, S. Model-Based Fuel Injection Control System for SI Engines. *SAE Trans.* **1996**, *105*, 1583–1593. [[CrossRef](#)]
119. Gu, F.; Ball, A.; Rao, K.K. Diesel Injector Dynamic Modelling and Estimation of Injection Parameters from Impact Response Part 2: Prediction of Injection Parameters from Monitored Vibration. *Proc. Inst. Mech. Eng. Part D J. Automob. Eng.* **1996**, *210*, 303–312. [[CrossRef](#)]

120. Nam, K.; Yoon, M.; Park, S.; Sunwoo, M. Development of a Sensorless Estimation Algorithm of the Injection Timing and Rate for an HSDI Common-Rail Injector. *Jsm Int. J. Ser. C Mech. Syst. Mach. Elem. Manuf.* **2004**, *47*, 882–888. [[CrossRef](#)]
121. Payri, R.; Tormos, B.; Salvador, F.J.; Plazas, A.H. Using one-dimensional modelling codes to analyse the influence of diesel nozzle geometry on injection rate characteristics. *Int. J. Veh. Des.* **2005**, *38*, 58–78. [[CrossRef](#)]
122. Baratta, M.; Catania, A.; Ferrari, A. Hydraulic Circuit Design Keys to Remove the Dependence of the Injected Fuel Amount on Dwell Time in Multi-Jet C.R. Systems. In Proceedings of the ASME 2006 Internal Combustion Engine Division Spring Technical Conference (ICES2006), Aachen, Germany, 7–10 May 2006. [[CrossRef](#)]
123. Chung, N.H.; Oh, B.G.; Sunwoo, M. Modelling and injection rate estimation of common-rail injectors for direct-injection diesel engines. *Proc. Inst. Mech. Eng. Part D J. Automob. Eng.* **2008**, *222*, 1089–1101. [[CrossRef](#)]
124. Catania, A.; Ferrari, A.; Manno, M. Development and Application of a Complete Multijet Common-Rail Injection-System Mathematical Model for Hydrodynamic Analysis and Diagnostics. *J. Eng. Gas Turbines Power (ASME)* **2008**, *130*, 062809. [[CrossRef](#)]
125. Catania, A.; Ferrari, A.; Manno, M.; Spessa, E. Experimental Investigation of Dynamics Effects on Multiple-Injection Common Rail System Performance. *J. Eng. Gas Turbines Power (ASME)* **2008**, *130*, 032806. [[CrossRef](#)]
126. Boudy, F.; Seers, P. Impact of physical properties of biodiesel on the injection process in a common-rail direct injection system. *Energy Convers. Manag.* **2009**, *50*, 2905–2912. [[CrossRef](#)]
127. Akiyama, H.; Yuasa, H.; Kato, A.; Saiki, T.; Sanada, K.; Kado, N. *Precise Fuel Control of Diesel Common-Rail System by Using OFEM*; SAE Technical Papers; SAE International: Warrendale, PA, USA, 2010. [[CrossRef](#)]
128. Battistoni, M.; Grimaldi, C.N. Numerical analysis of injector flow and spray characteristics from diesel injectors using fossil and biodiesel fuels. *Appl. Energy* **2012**, *97*, 656–666. [[CrossRef](#)]
129. d’Ambrosio, S.; Ferrari, A. Diesel Injector Coking: Optical-Chemical Analysis of Deposits and Influence on Injected Flow-Rate, Fuel Spray and Engine Performance. *J. Eng. Gas Turbines Power* **2012**, *134*, 062801. [[CrossRef](#)]
130. Ferrari, A.; Mittica, A.; Spessa, E. Benefits of Hydraulic Layout over Driving System in Piezo Injectors and Proposal of a New-Concept CR Injector with an Integrated Minirail. *Appl. Energy* **2013**, *103*, 243–255. [[CrossRef](#)]
131. Vass, S.; Németh, H. Sensitivity analysis of instantaneous fuel injection rate determination for detailed Diesel combustion models. *Period. Polytech. Transp. Eng.* **2013**, *41*, 77–85. [[CrossRef](#)]
132. Parotto, M.; Sgatti, S.; Sensi, F. *Advanced GDI Injector Control with Extended Dynamic Range*; SAE Technical Papers; SAE International: Warrendale, PA, USA, 2013. [[CrossRef](#)]
133. Postriotti, L.; Malaguti, S.; Bosi, M.; Buitoni, G.; Piccinini, S.; Bagli, G. Experimental and numerical characterization of a direct solenoid actuation injector for Diesel engine applications. *Fuel* **2014**, *118*, 316–328. [[CrossRef](#)]
134. D’Ambrosio, S.; Finesso, R.; Fu, L.; Mittica, A.; Spessa, E. A control-oriented real-time semi-empirical model for the prediction of NOx emissions in diesel engines. *Appl. Energy* **2014**, *130*, 265–279. [[CrossRef](#)]
135. Salvador, F.J.; Payri, R.; Carreres, M. Fuel temperature influence on the performance of a last generation common-rail diesel ballistic injector. Part I: Experimental mass flow rate measurements and discussion. *Energy Convers. Manag.* **2016**, *114*, 364–375. [[CrossRef](#)]
136. Duke, D.J.; Kastengren, A.L.; Matusik, K.E.; Swantek, A.B.; Powell, C.F.; Payri, R.; Vaquerizo, D.; Itani, L.; Bruneaux, G.; Grover, R.O.; et al. Internal and near nozzle measurements of Engine Combustion Network “Spray G” gasoline direct injectors. *Exp. Therm. Fluid Sci.* **2017**, *88*, 608–621. [[CrossRef](#)]
137. Ferrari, A.; Novara, C.; Paolucci, E.; Vento, O.; Violante, M.; Zhang, T. A new closed-loop control of the injected mass for a full exploitation of digital and continuous injection-rate shaping. *Energy Convers. Manag.* **2018**, *177*, 629–639. [[CrossRef](#)]
138. Xu, L.; Bai, X.S.; Jia, M.; Qian, Y.; Qiao, X.; Lu, X. Experimental and modeling study of liquid fuel injection and combustion in diesel engines with a common rail injection system. *Appl. Energy* **2018**, *230*, 287–304. [[CrossRef](#)]
139. Soriano, J.A.; Mata, C.; Armas, O.; Avila, C.D. A zero-dimensional model to simulate injection rate from first generation common rail diesel injectors under thermodynamic diagnosis. *Energy* **2018**, *158*, 845–858. [[CrossRef](#)]
140. Mancaruso, E.; Perozziello, C.; Sequino, L. *1D Modeling of Alternative Fuels Spray in a Compression Ignition Engine Using Injection Rate Shaping Strategy*; SAE Technical Papers; SAE International: Warrendale, PA, USA, 2019. [[CrossRef](#)]
141. Shi, C.; Ji, C.; Wang, S.; Yang, J.; Zedong, M.; Ge, Y. Combined influence of hydrogen direct-injection pressure and nozzle diameter on lean combustion in a spark-ignited rotary engine. *Energy Convers. Manag.* **2019**, *195*, 1124–1137. [[CrossRef](#)]
142. Ferrari, A.; Paolicelli, F. A virtual injection sensor by means of time frequency analysis. *Mech. Syst. Signal Process.* **2019**, *116*, 832–842. [[CrossRef](#)]
143. Gao, Z.; Li, G.X.; Xu, C.; Li, H.; Wang, M. A calculation method and experiment study of high-pressure common rail injection rate with solenoid injectors. *Sci. Prog.* **2021**, *104*, 00368504211026157. [[CrossRef](#)] [[PubMed](#)]
144. Ferrari, A.; Jin, Z.; Vento, O.; Zhang, T. An injected quantity estimation technique based on time–frequency analysis. *Control Eng. Pract.* **2021**, *116*, 104910. [[CrossRef](#)]
145. Yang, X.; Zhou, T.; Dong, Q.; Lu, C.; Ni, Z. Research on innovative one-dimensional mathematical model applied to the on-line measurement for transient discharge coefficient of diesel injector nozzle. *Int. J. Engine Res.* **2021**, *24*, 132–146. [[CrossRef](#)]
146. Ataç, O.; Lee, S.; Moon, S.; Ataç, O.; Lee, S.; Moon, S. Development of simplified model for injection rate prediction of diesel injectors during transient and steady operation. *Fuel* **2022**, *324*, 124655. [[CrossRef](#)]

147. Liu, B.; Fei, H.; Wang, L.; Fan, L.; Yang, X. Real-time estimation of fuel injection rate and injection volume in high-pressure common rail systems. *Energy* **2024**, *298*, 131386. [[CrossRef](#)]
148. Hu, C.; Wu, Z.; Ferrari, A.; Ji, M.; Deng, J.; Vento, O. Numerical Study on Internal Flow and Cavitation Characteristics of GDI Injectors for Different Nozzle Orifice Geometries. *Energies* **2024**, *17*, 4114. [[CrossRef](#)]
149. Zhang, T. An estimation method of the fuel mass injected in large injections in Common-Rail diesel engines based on system identification using artificial neural network. *Fuel* **2021**, *310*, 122404. [[CrossRef](#)]
150. Lu, X.; Zhao, J.; Markov, V.; Wu, T. Study on precise fuel injection under multiple injections of high pressure common rail system based on deep learning. *Energy* **2024**, *307*, 132784. [[CrossRef](#)]
151. Farooqi, Q.; Snyder, B.; Anwar, S. Real time monitoring of diesel engine injector waveforms for accurate fuel metering and control. *J. Control Sci. Eng.* **2013**, *2013*, 973141. [[CrossRef](#)]
152. Ferrari, A.; Paolicelli, F.; Pizzo, P. The new-generation of solenoid injectors equipped with pressure-balanced pilot valves for energy saving and dynamic response improvement. *Appl. Energy* **2015**, *151*, 367–376. [[CrossRef](#)]
153. Ferrari, A.; Pizzo, P. Optimization of an Algorithm for the Measurement of Unsteady Flow-Rates in High-Pressure Pipelines and Application of a Newly Designed Flowmeter to Volumetric Pump Analysis. *J. Eng. Gas Turbines Power (ASME)* **2016**, *138*, 031604. [[CrossRef](#)]
154. Ferrari, A.; Mittica, A. Response of different injector typologies to dwell time variations and a hydraulic analysis of closely-coupled and continuous rate shaping injection schedules. *Appl. Energy* **2016**, *169*, 899–911. [[CrossRef](#)]
155. Payri, R.; Salvador, F.J.; Carreres, M.; De la Morena, J. Fuel temperature influence on the performance of a last generation common-rail diesel ballistic injector. Part II: 1D model development, validation and analysis. *Energy Convers. Manag.* **2016**, *114*, 376–391. [[CrossRef](#)]
156. Zhang, Q.; Hao, Z.; Zheng, X.; Yang, W.y. Characteristics and effect factors of pressure oscillation in multi-injection DI diesel engine at high-load conditions. *Appl. Energy* **2017**, *195*, 52–66. [[CrossRef](#)]
157. Yu, W.; Yang, W.; Zhao, F. Investigation of internal nozzle flow, spray and combustion characteristics fueled with diesel, gasoline and wide distillation fuel (WDF) based on a piezoelectric injector and a direct injection compression ignition engine. *Appl. Therm. Eng.* **2017**, *114*, 905–920. [[CrossRef](#)]
158. Li, Y.; Duan, X.; Fu, J.; Liu, J.; Wang, S.; Dong, H.; Xie, Y. Development of a method for on-board measurement of instant engine torque and fuel consumption rate based on direct signal measurement and RGF modelling under vehicle transient operating conditions. *Energy* **2019**, *189*, 116218. [[CrossRef](#)]
159. Sun, P.; Xin, B.; Wang, X.; Zhang, H.; Long, L.; Wang, Q. Research on Correction of Flow Characteristics in Ballistic Zone of GDI Engine Injector. In Proceedings of the 2020 4th CAA International Conference on Vehicular Control and Intelligence (CVCI), Hangzhou, China, 18–20 December 2020. [[CrossRef](#)]
160. Zhao, J.; Grekhov, L.; Yue, P. Limit of Fuel Injection Rate in the Common Rail System under Ultra-High Pressures. *Int. J. Automot. Technol.* **2020**, *21*, 649–656. [[CrossRef](#)]
161. Ma, X.; Lei, Y.; Qiu, T.; Wang, J.; Yue, G. Investigation of fuel injection rate identification algorithm based on rail pressure fluctuation characteristics induced by injection. *Proc. Inst. Mech. Eng. Part D J. Automob. Eng.* **2021**, *236*, 1101–1114. [[CrossRef](#)]
162. Yang, X.; Dong, Q.; Song, J.; Zhou, T. Investigation of a method for online measurement of injection rate for a high-pressure common rail diesel engine injector under multiple-injection strategies. *Meas. Sci. Technol.* **2021**, *33*, 025301. [[CrossRef](#)]
163. Lešnik, L.; Kegl, B.; Torres-Jiménez, E.; Cruz-Peragón, F.; Mata, C.; Biluš, I. Effect of the In-Cylinder Back Pressure on the Injection Process and Fuel Flow Characteristics in a Common-Rail Diesel Injector Using GTL Fuel. *Energies* **2021**, *14*, 452. [[CrossRef](#)]
164. Jin, Z.; Vento, O.; Zhang, T.; Ferrari, A.; Mittica, A.; Ouyang, L.; Tan, S. Numerical-Experimental Optimization of the Common-Feeding Injection System Concept for Application to Light-Duty Commercial Vehicles. *J. Dyn. Syst. Meas. Control* **2021**, *143*, 122304. [[CrossRef](#)]
165. Markov, V.; Sa, B.; Devyanin.; Grekhov, L.; Neverov, V.; Zhao, J. Numerical analysis of injection and spray characteristics of diesel fuel and rapeseed oil in a diesel engine. *Case Stud. Therm. Eng.* **2022**, *35*, 102129. [[CrossRef](#)]
166. Ferrari, A.; Vento, O. Thermal effects on Ouyang Rail injection system hydraulic performance. *Int. J. Engine Res.* **2023**, *24*, 3602–3612. [[CrossRef](#)]
167. Ventura, L.; Finesso, R.; Malan, S. Development of a Model-Based Coordinated Air-Fuel Controller for a 3.0 dm<sup>3</sup> Diesel Engine and Its Assessment through Model-in-the-Loop. *Energies* **2023**, *16*, 907. [[CrossRef](#)]
168. Ferrari, A.; Novara, C.; Vento, O.; Violante, M.; Zhang, T. A novel fuel injected mass feedback-control for single and multiple injections in direct injection systems for CI engines. *Fuel* **2023**, *334*, 126670. [[CrossRef](#)]
169. Henry, M.; Leach, F. Coriolis Mass Flow Metering Tracking Rapid Fuel Injection Pulse Trains In Internal Combustion Engines. In Proceedings of the 4th Conference on Microfluidic Handling Systems, Enschede, The Netherlands, 2–4 October 2019.
170. Ferrari, A.; Zhang, T. Benchmark between Bosch and Zeuch method-based flowmeters for the measurement of the fuel injection rate. *Int. J. Engine Res.* **2021**, *22*, 316–327. [[CrossRef](#)]
171. Schulz, C.; Sick, V. Tracer-LIF diagnostics: Quantitative measurement of fuel concentration, temperature and fuel/air ratio in practical combustion systems. *Prog. Energy Combust. Sci.* **2005**, *31*, 75–121. [[CrossRef](#)]
172. Gu, F.; Ball, A. Diesel Injector Dynamic Modelling and Estimation of Injection Parameters from Impact Response Part 1: Modelling and Analysis of Injector Impacts. *Proc. Inst. Mech. Eng. Part D J. Automob. Eng.* **1996**, *210*, 293–302. [[CrossRef](#)]

173. Pickl, F.; Russer, M.; Hauenstein, M.; Wensing, M. Modelling and understanding deposit formation and reduction in combustion engines—Application to the concrete case of internal GDI injector deposit. *Fuel* **2019**, *236*, 284–296. [[CrossRef](#)]
174. Lin, Z.; Liu, S.; Sun, Q.; Qi, Y.; Wang, Z. Numerical investigation of multiple hydrogen injection in a jet ignition ammonia-hydrogen engine. *Int. J. Hydrogen Energy* **2024**, *77*, 336–346. [[CrossRef](#)]
175. Catania, A.E.; Ferrari, A.; Manno, M.; Spessa, E. A Comprehensive Thermodynamic Approach to Acoustic Cavitation Simulation in High-Pressure Injection Systems by a Conservative Homogeneous Two-Phase Barotropic Flow Model. *J. Eng. Gas Turbines Power* **2005**, *128*, 434–445. [[CrossRef](#)]
176. Macián, V.; Payri, R.; Ruiz, S.; Bardi, M.; Plazas, A.H. Experimental study of the relationship between injection rate shape and Diesel ignition using a novel piezo-actuated direct-acting injector. *Appl. Energy* **2014**, *118*, 100–113. [[CrossRef](#)]
177. Chung, J.; Oh, S.; Min, K.; Sunwoo, M. Real-time combustion parameter estimation algorithm for light-duty diesel engines using in-cylinder pressure measurement. *Appl. Therm. Eng.* **2013**, *60*, 33–43. [[CrossRef](#)]
178. Ganesh, R.H.; Subramanian, V.; Balasubramanian, V.; Mallikarjuna, J.M.; Ramesh, A.; Sharma, R. Hydrogen fueled spark ignition engine with electronically controlled manifold injection: An experimental study. *Renew. Energy* **2008**, *33*, 1324–1333. [[CrossRef](#)]
179. Khalid, A.H.; Said, M.F.M.; Veza, I.; Abas, M.A.; Roslan, M.F.; Abubakar, S.; Jalal, M. Hydrogen port fuel injection: Review of fuel injection control strategies to mitigate backfire in internal combustion engine fuelled with hydrogen. *Int. J. Hydrogen Energy* **2024**, *66*, 571–581. [[CrossRef](#)]
180. Taghavifar, H.; Khalilarya, S.; Jafarmadar, S. Diesel engine spray characteristics prediction with hybridized artificial neural network optimized by genetic algorithm. *Energy* **2014**, *71*, 656–664. [[CrossRef](#)]
181. Pos, R.; Wardle, R.W.M.; Cracknell, R.; Ganippa, L. Spatio-temporal evolution of diesel sprays at the early start of injection. *Appl. Energy* **2017**, *205*, 391–398. [[CrossRef](#)]
182. Sun, Z.Y.; Li, G.X.; Chen, C.; Yu, Y.-S.; Gao, G.X. Numerical investigation on effects of nozzle’s geometric parameters on the flow and the cavitation characteristics within injector’s nozzle for a high-pressure common-rail DI diesel engine. *Energy Convers. Manag.* **2015**, *89*, 843–861. [[CrossRef](#)]

**Disclaimer/Publisher’s Note:** The statements, opinions and data contained in all publications are solely those of the individual author(s) and contributor(s) and not of MDPI and/or the editor(s). MDPI and/or the editor(s) disclaim responsibility for any injury to people or property resulting from any ideas, methods, instructions or products referred to in the content.