

Geometric interpretation of P.L. Nervi surfaces

Original

Geometric interpretation of P.L. Nervi surfaces / Perri, Stefano; Patrucco, Giacomo; Sammartano, Giulia; Spano',
Antonia - In: The Halls of Turin Exhibition Center by Pier Luigi Nervi: a multi-disciplinary approach for diagnosis and
preservationELETTRONICO. - Los Angeles : Getty foundation, 2023. - pp. 141-153

Availability:

This version is available at: 11583/2993742 since: 2024-10-30T09:39:53Z

Publisher:

Getty foundation

Published

DOI:

Terms of use:

This article is made available under terms and conditions as specified in the corresponding bibliographic description in
the repository

Publisher copyright

(Article begins on next page)

3b Geometric interpretation of P.L. Nervi surfaces

Stefano Perri¹, Giacomo Patrucco¹, Giulia Sammartano^{1,2}, Antonia Spanò^{1,2}

¹ Politecnico di Torino, Department of Architecture and Design. LabG4CH - Laboratory of Geomatics for cultural Heritage. antonia.spano,giacomo.patrucco,stefano.perri,giulia.sammartano@polito.it

² Politecnico di Torino, FULL - Future Urban Legacies Lab interdepartmental centre

Geometry has always been a means of proportioning and sizing architectural constructions and has permeated the ways of conceiving buildings from the classical, modern, and contemporary ages, ensuring aesthetic and technical values and thrilling architects and treatise writers.

Structural engineering and studies to evaluate the structural behavior of masonry structures are consequently often aimed at highlighting the close relationship between the geometry and the safety level of structures, such as the arches, the vaulted systems and the domes in particular, based on the primitive geometries of architectural heritage.

Nonetheless, even when geometric techniques aim to assess the buildings' state of health, they provide strategies for directly comparing the architectural forms detected with reality-based techniques, i.e. photogrammetric or laser scanning, with models of primitive geometries that are interpreted as used by the designers in the construction (spheres, cylinders, etc.), to highlight whether or not alterations of the architectural elements exist.

As regards the works of P.L. Nervi, it has been established and shared that the "reckless static intuitions" combine with a structural conception that is inspired by and ends in geometry, and from which the designer draws an aesthetic and constructive synthesis.

Both the reports of his activity as a designer and builder and the reinterpretations of his work reveal the close connection between the new, spatial concepts and the scrupulous craftsmanship in manipulating materials arising from innovative construction systems, such as the patented ferrocement, which generates architectural spaces that continue to encapsulate their own modernity.

It is interesting to consider that the NerViLab research activities, which aimed to represent and analyze Nervi's exemplary synthesis between structural composition, geometric shape and construction, are based on the reconstruction of digital models. These were then retranslated into physical models

by means of stereolithography, starting from the documentary complex of the project and executive drawings of Nervi's works.

The Nervi laboratory of the Milan Polytechnic uses models, original drawings, a rich photographic set of construction site images and topical photos to illustrate Pier Luigi Nervi's entire creative path. It has worked in close collaboration with the PLN Project, a foundation committed to the protection of Pier Luigi Nervi's architectural heritage in Italy and internationally, contributing to the development of a design culture to redevelop modern architecture via didactic and dissemination activities,

In this context, the contribution we propose downstream of the 3D metric survey of the Nervi pavilions in the Turin Exhibition Center. Despite the partiality of the investigations on the project geometries investigated, this coincides with the interpretation of the geometric matrix of the designed form, directly deduced from the constructed form. It uses the reality-based model derived from the 3D metric survey with geometric techniques to subsequently compare them with the project drawings of the designer Nervi.

As already highlighted above (paragraph 3a), the finalization of multi-sensor and multi-scale models derived from the 3D metric survey supports different purposes. These range from a global knowledge of the spaces which focus on the thickness of the structural and ferrocement elements, to the morphological characterization of the structural elements, suitable for identifying architectural values. The latter also support the detection of not only a possible mechanical deterioration of the elements, but also a degradation of the surfaces.

In the next sub-paragraphs, it will be possible to observe some experiments carried out on the constructive elements of Halls B and C, which also introduce the developments of paragraph 3c aimed at identifying possible alterations of the shapes. These investigations are often only possible when the original shape of the building elements is clarified in advance.

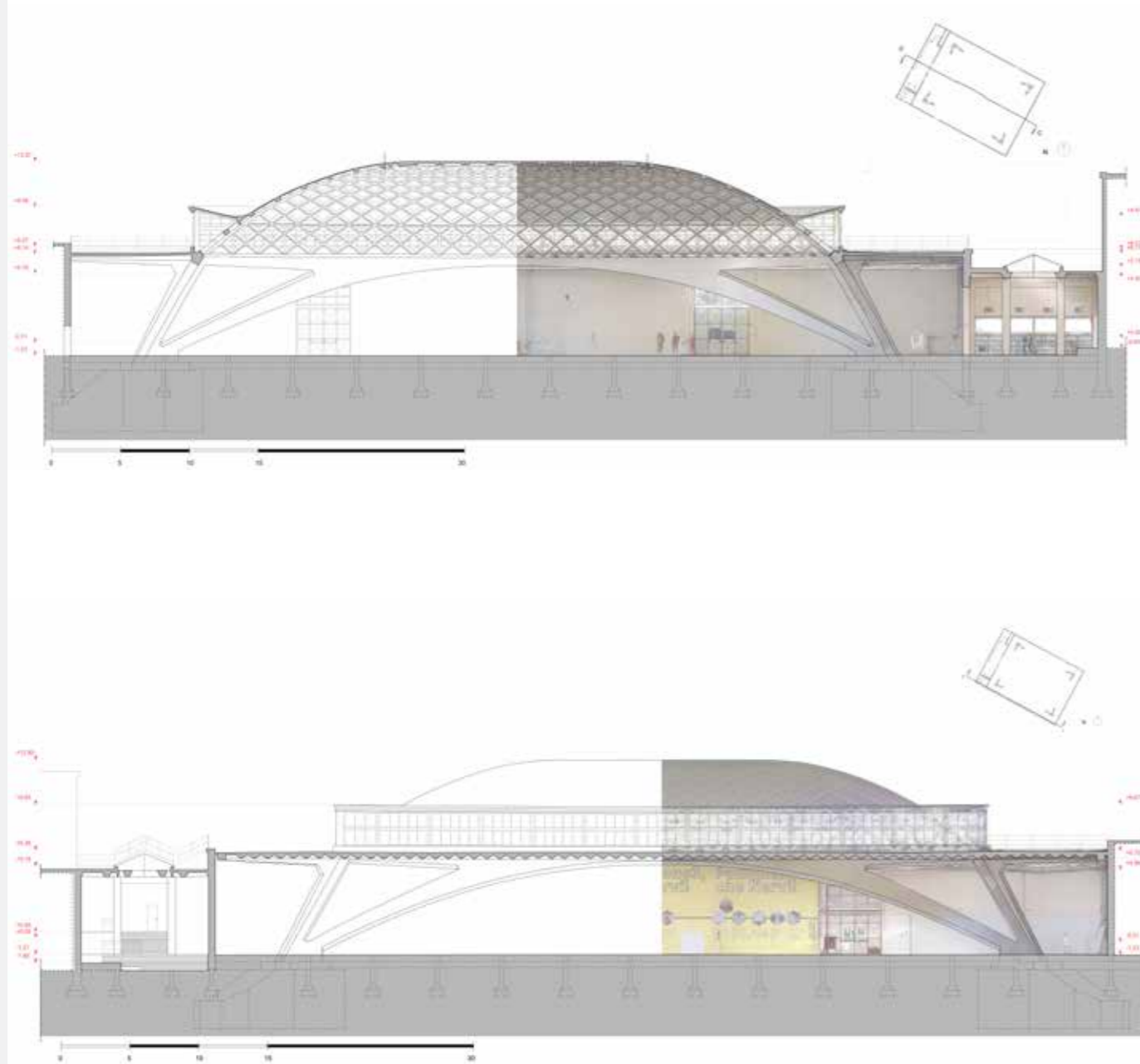

3a10.10 and 3.10.11: Two longitudinal sections of Hall C, with and without the orthophoto

3b.1 Geometric characterization of structural elements of the vaults and arches of Halls B and C

The identification and extraction of geometric primitives or generative curves is certainly one of the possible strategies that enable *as-built* modeling, as will be summarized in Chap. 8, as it enables the surface of an architectural element to be approximated to a generating geometry. When this is possible, this strategy has the simultaneous role of hypothesizing or verifying the nature of possible shape anomalies as, if the project was undoubtedly based on geometric principles, it is easy to compare whether the accurately detected architectural elements deviate from the tracking geometries of the constructed elements. This investigation was adopted for the surfaces of the vaulted roofs and the arches of the two halls.

It is important to stress that Nervi used low arches and low vaults, as he wanted to obtain a brand new spatiality. The arches and vaults he conceived are obviously very different from traditional masonry structures, as by using reinforced concrete, he was able to incline the pilasters in order to face weights in a non-vertical direction. Among the original drawings conserved in the CSAC archive (Centro Studi e Archivio Della Comunicazione dell' Università di Parma), some drawings are definitely missing. However, we know from the preserved drawings for Hall C that Nervi used parabolic curves (Figure 3b 1.5)

As regards the vaults of Hall B (Figure 3b 1.1), we can observe some interesting proportions and percentages values compared to the round arch of the so-called SAP vault (reinforced concrete-brick vault) in Hall B, and located between the ribbed dome of the apse and the wave vault of the main room.

It is possible to compare the section of the vault, presuming that the primitive generating geometry is a parabolic arch, which is so similar to a circular cylinder with a 28.88 m radius. The deviation from the section performed on the reality-based model and the interpolated circle is approximately 3.5-4 cm (observed at the key point, close to the springer plane); the parabolic arches of Hall C, the profile of which is documented by Nervi's original drawings, also differ from the interpolated

circular arch by 4cm. It is quite unbelievable that Nervi's construction site was able to preserve such a small, almost insignificant dimensional difference between the circular and parabolic arches, compared to the huge breadth of the vault (39.54 m.). A more detailed analysis of the shape will be presented in the next paragraph.

What is very interesting is the observation regarding the length of the vault: assuming the similarity to a circular cylinder, the vault in place is 48% of the semi-cylinder that has corresponded to the round arch in architecture for many centuries. In fact, the subtended angle of the SAP vault is close to 87° (sexagesimal). This information suggests that Nervi thought of using a portion of a parabolic cylinder subtended by a right angle, and the necessary adaptation to the real form imposed a very small deviation from a pure geometric value.

If we verify the same quantities referring to the very large wave vault of Hall B (Figure 3b 1.3), we find that the cylindrical surface of the extrados that constitutes the lowered vault has a length of 73.78 m, which corresponds to 38.9% of the generator half cylinder. For the surface of the intrados, we find that the vault is reduced to 34.6% of the generator half cylinder.

The transversal section of the huge space of Hall B shows how Nervi conceived the combination of structural elements, designing a transversal section of inclined pilasters as a continuation of the vault.

It is surprising to realize that if the surface is extended to the floor of Hall B, we can see that the angle subtended by the portion of the cylindrical section of the vault is again close to the right angle (88°). It is quite a fascinating idea that Nervi was able to trigger the design of his vaults by defining those portions of the (parabolic) cylinder subtended by angles of 90 degrees as lowered vaults, which he then adapted to slightly smaller extensions in the executive phases of the project.

Obviously, after these observations, we moved on to examine the arches and the vault of Hall C.

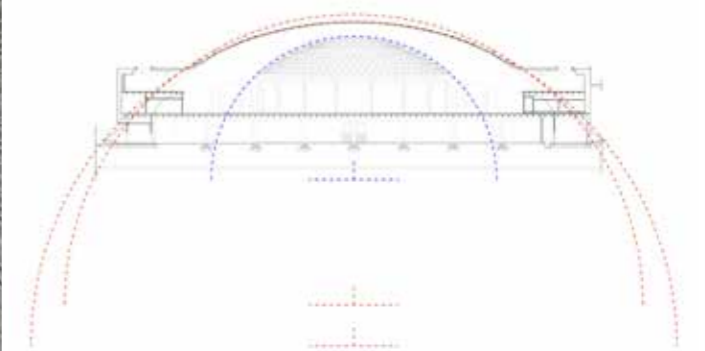

3b 1.1 (above): The wave vault of Hall B and the so-called SAP vault (reinforced concrete-brick vault) with some decay have been investigated in depth. (below) A diagram of the studied curves (dashed blue line for SAP vault and dashed red line for waved vault) overlapped to the transversal section of Hall B.

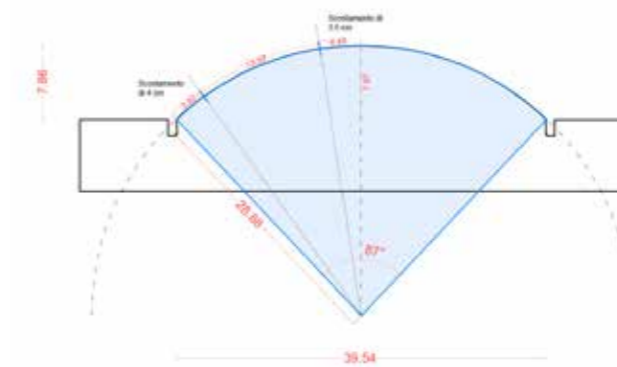

Cylinder radius:
28.88 m
Length of the lowered arch
(in comparison with the round arch):
43.74 m = 48.11 % of the round arch
Subtended angle:
87° (sexagesimal)

3.b.1.2 The geometric diagram highlights the subtended angle of the SAP vault close to the right angle, and the deviation from the perfect circular shape of the vault merely a few centimeters away from the key and the spring of the arch.

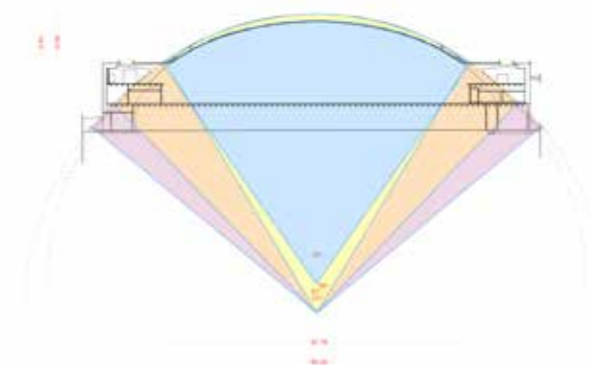

Cylinder radius:
Extrados: 60.38 m
Intrados: 65.44 m
Length of the lowered profile vault:
Extrados 38.9% of the round arch
Intrados 34.6% of the round arch
Intrados subtended angle: 70%
Extrados subtended angle: 62%

3b 1.3: The transversal section of the wave vault of Hall B again shows that if we consider the cylinder ideally extended to the ground floor, the subtended arc is close to the round angle.



3b 1.4. (above): an internal view of the space of Hall C. (below) A classic geometric generation of a barrel vault with pavilion heads

In general terms, we can say that Hall C was conceived as a barrel vault with pavilion heads (figure 3b 1.4). In the classic generation, a half cylinder with the axis parallel to the largest dimension of the hall is intersected by two half cylinders with a principal axis perpendicular to the first, and the cylinder lenses are retained and the nails removed, which is a variant of a cloister vault.

In addition to the general volume, it is possible for Hall C to follow the design phases and accurate drawing of the curves of the arches and of the vault. The arches that support the vault are special, double-curved arches, i.e. they show a curve both in the vertical and horizontal projection, a sign they have been conceived in the space, to counter once again the weight of the vault with thrust loads most certainly not in a vertical direction.

Pier Luigi Nervi carefully designed the parabolic arches of Hall C, tracing them by points with centimetric precision (Figure 3b 1.5).

The analytical verification (using Excel software) provides us with the equation of the parabola devised by Nervi: R-squared, which is also known as the coefficient of determination, is a

statistical measure of how well the regression model fits the observed data. In this case (99%) Nervi's parabola is perfectly estimated. (Figure 3b 1.6 left)

On the other hand, we carried out the graphic assessment of the comparison with the arches measured using the LiDAR technique which, as seen in paragraph 3a, have a sub-centimetric accuracy. This shows that the parabolic curve used by Nervi to construct the work should certainly not have been the one shown in drawing n°. 3975. (Figure 3b 1.6 right).

We continued this study by calculating the equation of the parabola and deriving the coordinates of the points from the drawing of the LiDAR survey. This also confirms that it is unambiguously a parabola (R^2 confirms with a value of 99%) (Figure 3b 1.7)

Considering that Nervi used parabolic curves to calculate the static behavior of the structures congruent to the load distribution, we verified that these curves are very similar to circular lowered arches.

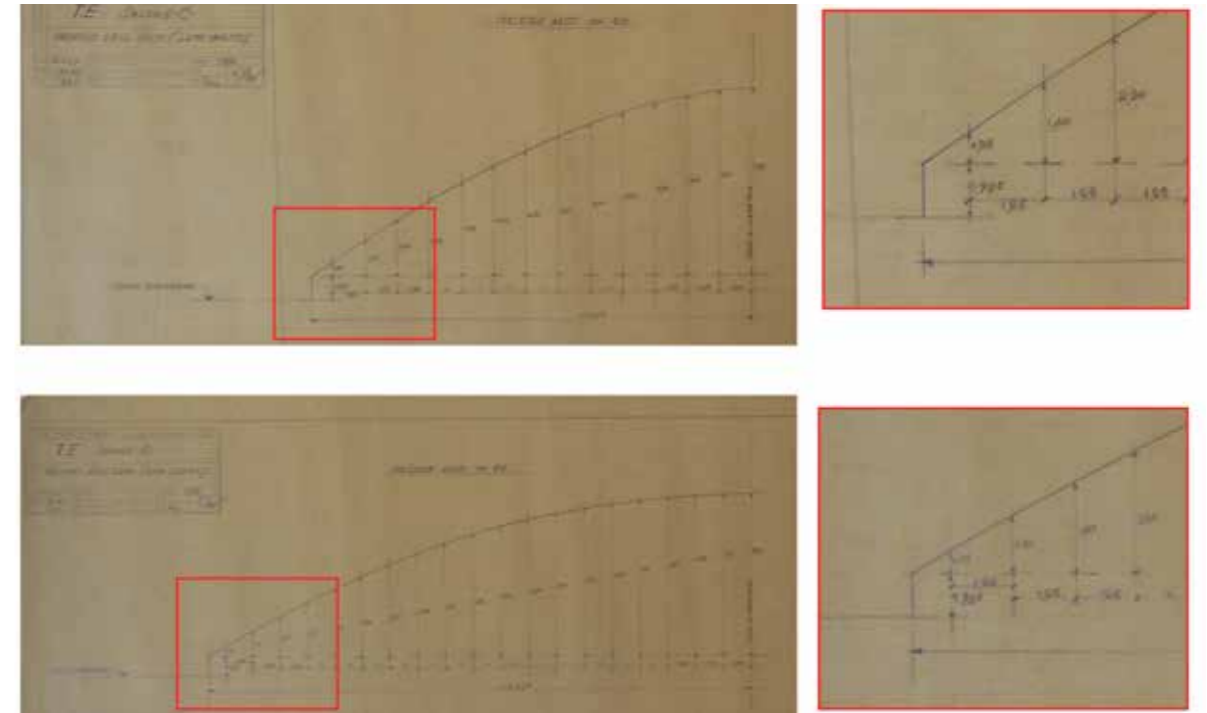

3b 1.5. Nervi's drawing of parabolic curves by points for the design of the double-curved arches of Hall C. (CSAC, Università di Parma, courtesy Fondation PLN Project)

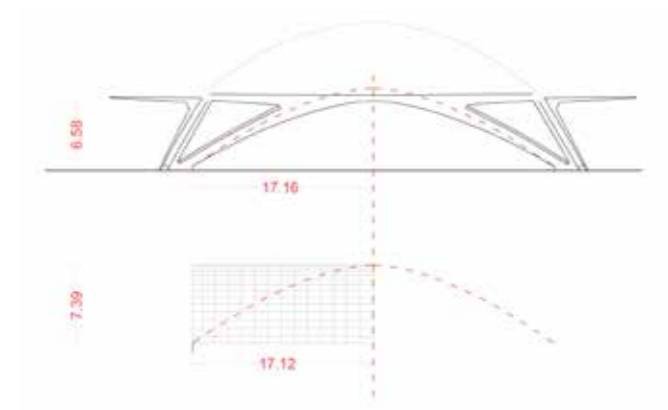
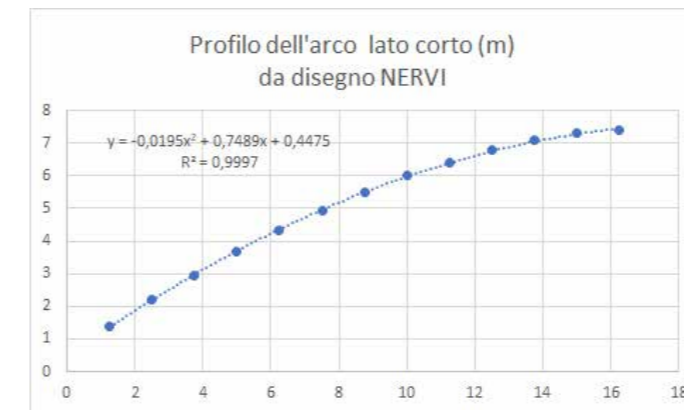

3b 1.6. (left): The analytical calculation of the parabola conceived by Nervi. (right) The graphic assessment comparing the parabolic curve designed is very different from the arc in situ, the projection drawing of which is derived from the LiDAR survey (sub-centimetric accuracy)

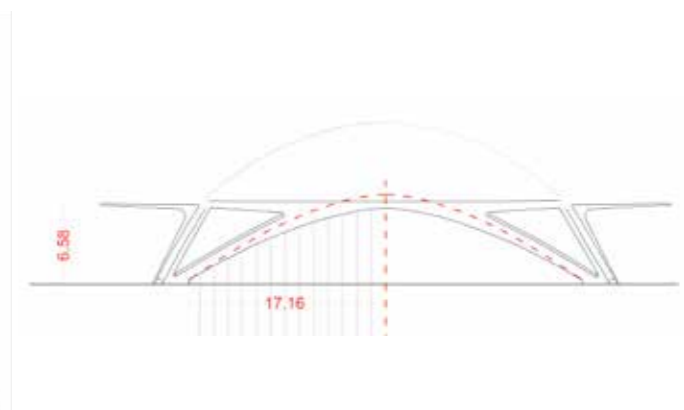
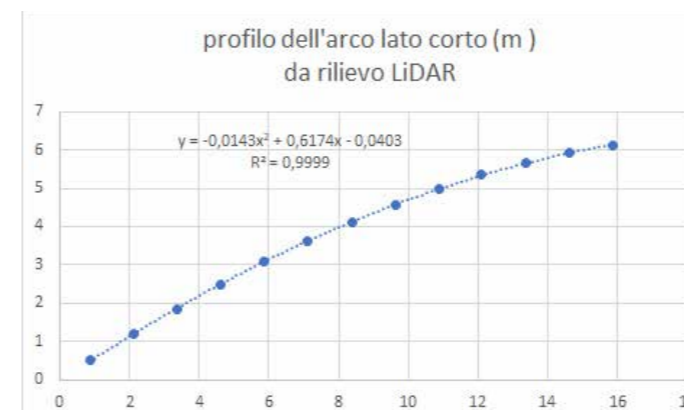

3b 1.7: Parabola equation (left) derived from coordinates of points detected on the drawing derived from LiDAR survey (right).

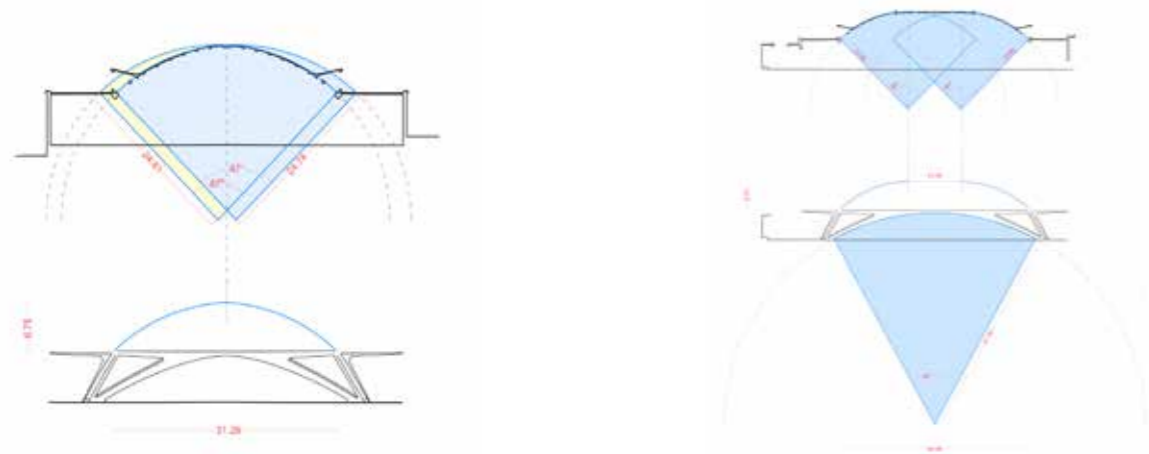

3b 1.8 (left): minor side of the Hall C section profiles: the angle subtending the vault is close to 87°; (right) the portions of parabolic cylinders are a few centimeters over 13 m away (instead of the planned distance of 15 m) and their extensions are subtended by angles of 87°.

Therefore, we agree that Nervi's choice to imply the right angle for the general sizing of parabolic cylinders perhaps recurs in both Hall B and Hall C.

The extension of the cylinder surface projected on a plane parallel to the shorter side of Hall C is again subtended by an angle of 87°, as the light of this vault is approximately 31.29 m. As regards the longer side of the room, the two cylinders constituting the heads of the cloister vault are 13.16 m away, and their extension is again close to 87°.

The study of the arches and the vault continued by analyzing and vectorizing other drawings preserved in the CSAC archive. In fact, there is a series of final drawings of the arches of Hall C, in which the careful design of the variable section of the arches is also estimated, planned and quoted with the precision of half a millimeter. (Figure 3b 1.9)

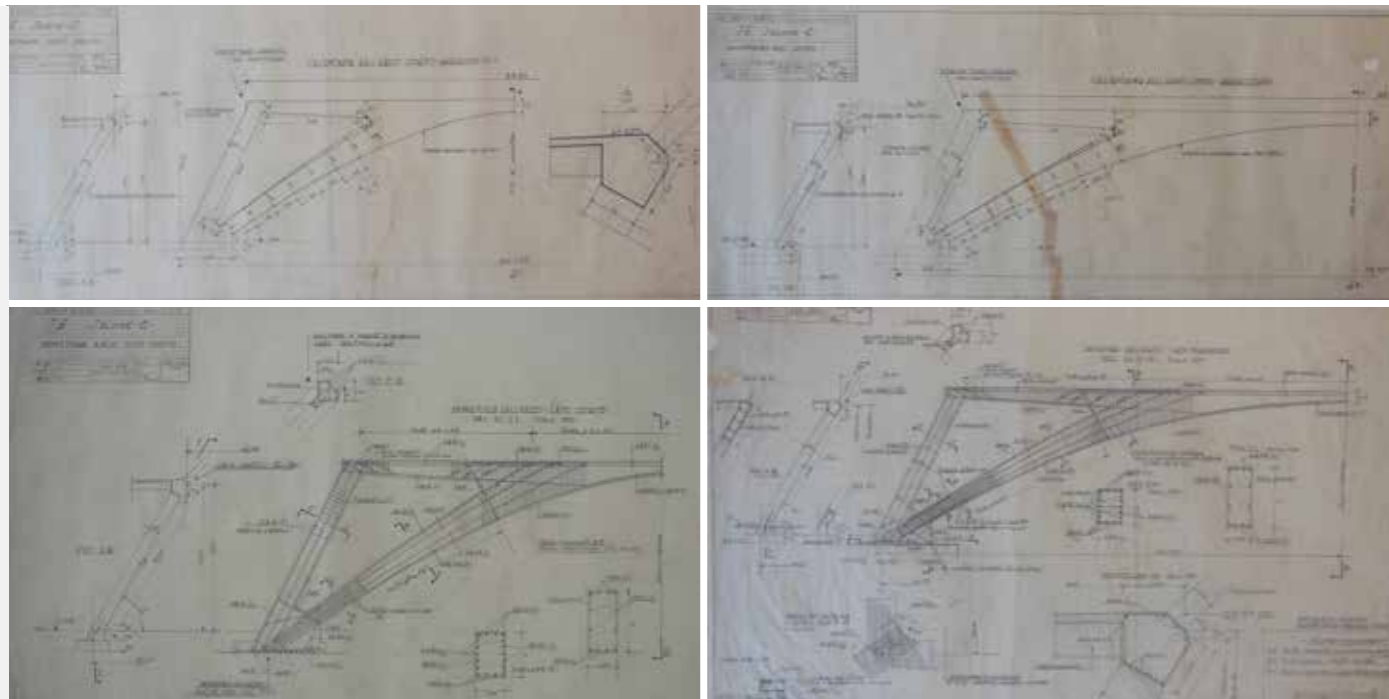

3b 1.9: A set of final drawings showing the high accuracy in planning the shape and dimension, including the variable resistant section of the arches of Hall C - (CSAC, Università di Parma, courtesy Fondation PLN Project)

If we vectorize these drawings and compare them with the drawings in vertical projection taken from the TLS survey (LiDAR technology), we are surprised to see significant dimensional differences: a different arch height of even 1.4 m¹. Figure 3b 1.10 shows the profiles extracted from the drawings by Pier Luigi Nervi (in red), which, therefore, although they are final, we must consider as merely provisional, as they exceed the built structure (drawn in black).

The differences between the planned and the built structure can also be observed in the comparison of the hall vault: it is interesting to note that Pier Luigi Nervi must have proceeded in consecutive steps to obtain the clarity of the arch-vault structure created. As can be seen in Figure 3b 1.11, if the drawings of the planned structure and the one created are aligned with the impost (springer) vault, there is a difference

of 1.15 m, whereas if they are aligned with the floor level, the deviation is reduced to 20 cm. In other words, before the construction phase, Nervi lowered the arches and streamlined the vault, which means that some other final drawings are missing.

A similar comparison is possible, although certainly with more detailed information, thanks to its continuous nature, by comparing the 3D relationship between the surface model obtained from Nervi's original drawings and the LiDAR point cloud (Figures 3.b.1.12 -13). The perfect 3D boundaries of the spatial differences of the two surfaces, again aligned with the impost of the vault and at floor level, inform us that both surfaces were created by Nervi's calculation, in which geometric principles, mathematical rigor and structural engineering led to a virtual synthesis.

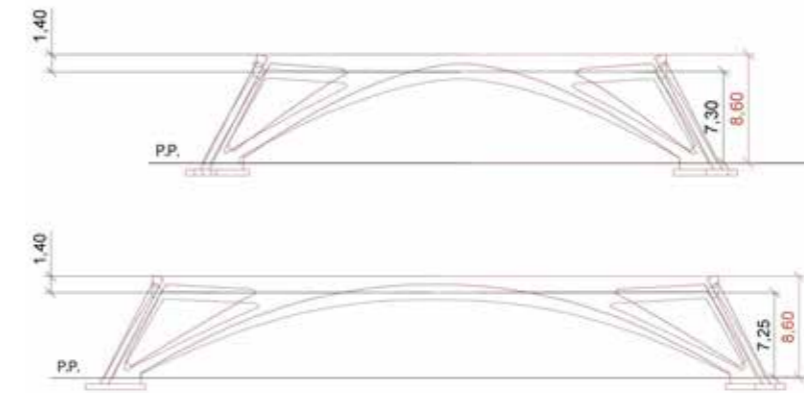

3b 1.10: Comparisons between the profiles of the arches projected by PL Nervi (red), and the profiles of the arches derived from the terrestrial laser scanning technique. (Ilaria Cofano drawings)

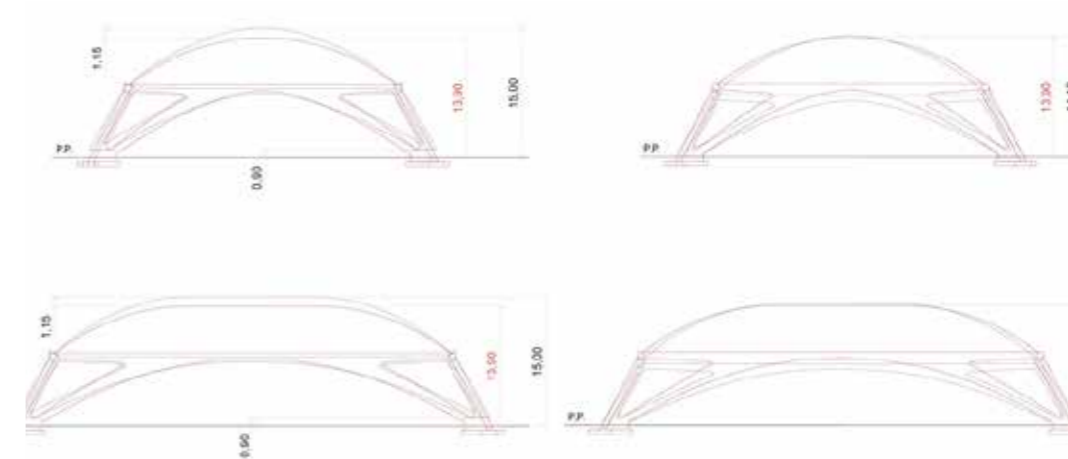

3b 1.11: Comparison between the projected structure (in red), and the in-situ arches and vault elements surveyed by the terrestrial laser scanning technique, (left) alignment based on the impost vault, (right) alignment based on the ground floor level. (Ilaria Cofano drawings)

1 The vectorized drawings and the comparison with the surveyed surfaces are by Ilaria Cofano. (Cofano 2022)

The ICP (Iterative Closest Points) algorithms enable two surfaces to be compared, starting from the base unit corresponding to each point of known 3D coordinates. These automatic procedures, plus the precise estimation, are interesting to the possibility of obtaining a direct quantitative control of the color range.

The epilogue of this compelling study of the proportions and mathematical characteristics of the geometric profiles of the arches and vault of Hall C ends with a new twist. One of Pier Luigi Nervi's drawing shows Hall C and a portion of Hall B (Figure 3b 1.14), which he evidently made to control the reciprocal volumes and to design the access stairs between

the two halls. The overall scale of this drawing shows decimetric rather than centimetric dimensions, to the extent that the symbol for approximately “~” used by Nervi is shown in a sectional drawing of the arches and vault of Hall C, which corresponds almost perfectly to the profiles and surfaces detected by our Geomatics team (Figure 3b 1.15).

Ultimately, we conclude that the supposed final and previously studied drawings were indeed provisional, there must have been definitive drawings of the structural geometric definition of the elements of pavilion C, and drawing n°. 3075 (Figure 3b 1.14) is certainly later.



3b 1.12: Spatial comparison of the two 3D models, the red version derived from Nervi's original drawings, and the gray version derived from the terrestrial laser scanning survey. (left) Alignment based on floor level, (right) alignment based on impost vault level (elaborated by S. Perri I. Cofano)

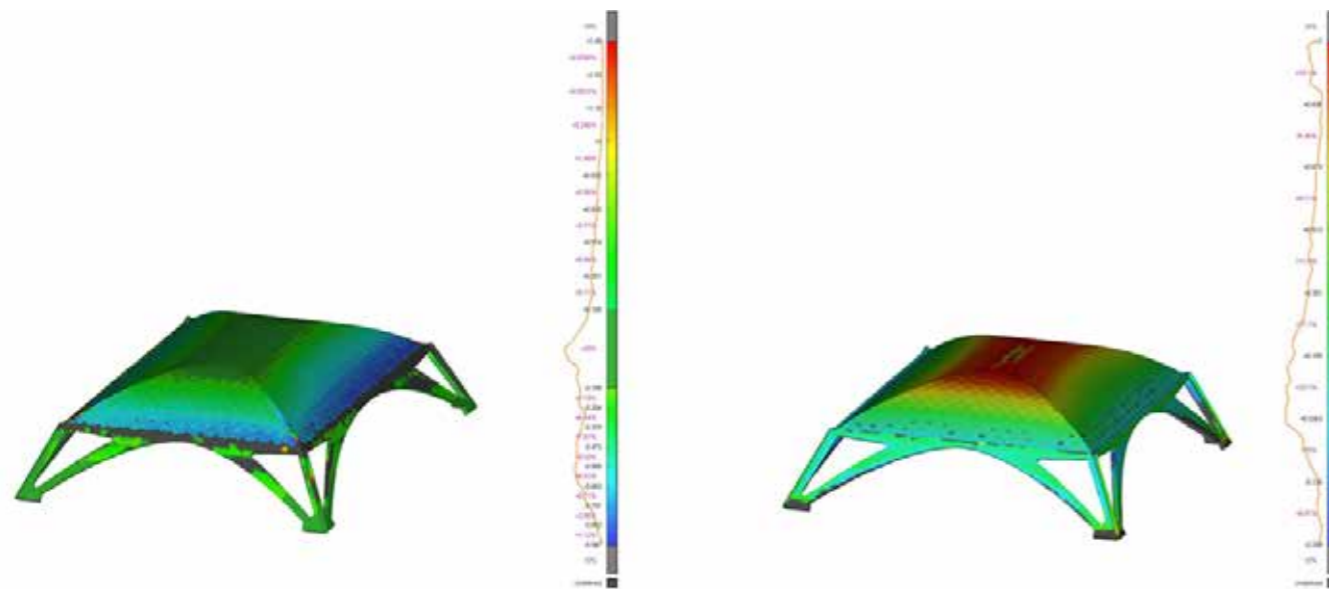

3b 1.13: Spatial comparison of the two 3D models made with the aid of an ICP algorithm that enables the point-to-point distances of its surfaces to be estimated. (left) Alignment based on floor level, (right) Alignment based on impost vault level (elaborated by S. Perri I. Cofano)

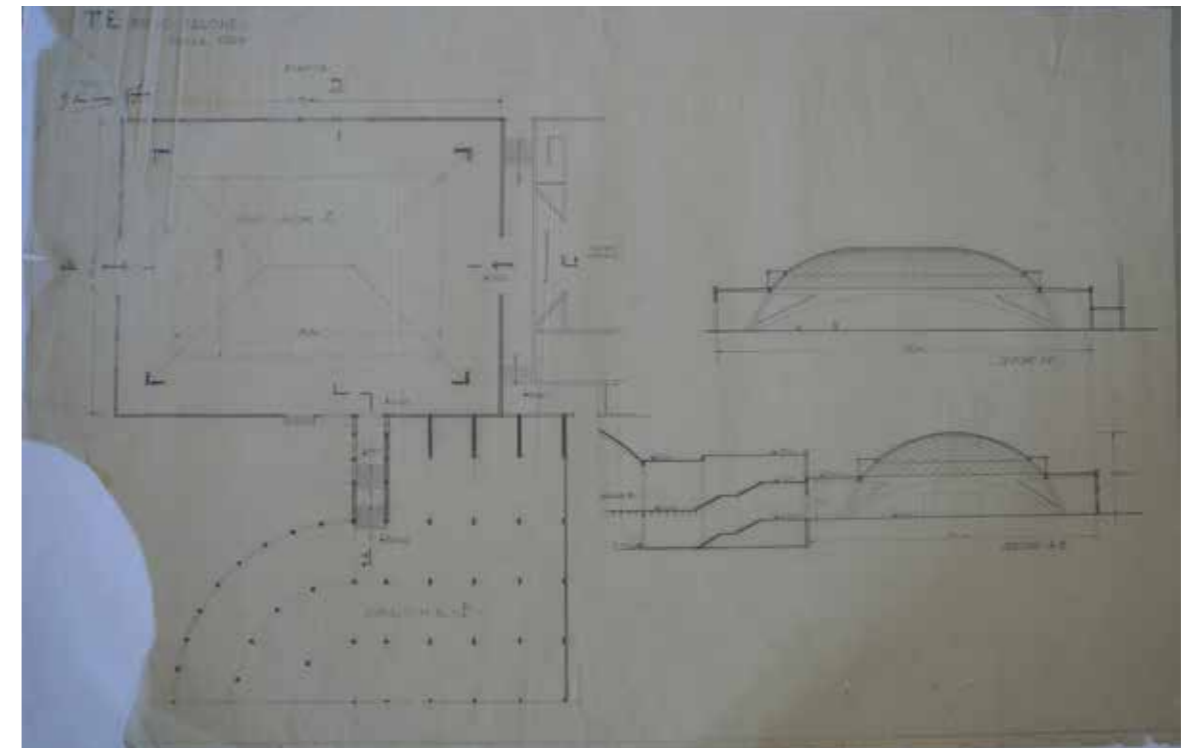

3b1.14: Drawing n°. 3075 (CSAC, Università di Parma, courtesy Fondation PLN Project), showing Hall C and a portion of Hall B with which Nervi aimed to design the access corridors and stairs between the two spaces.

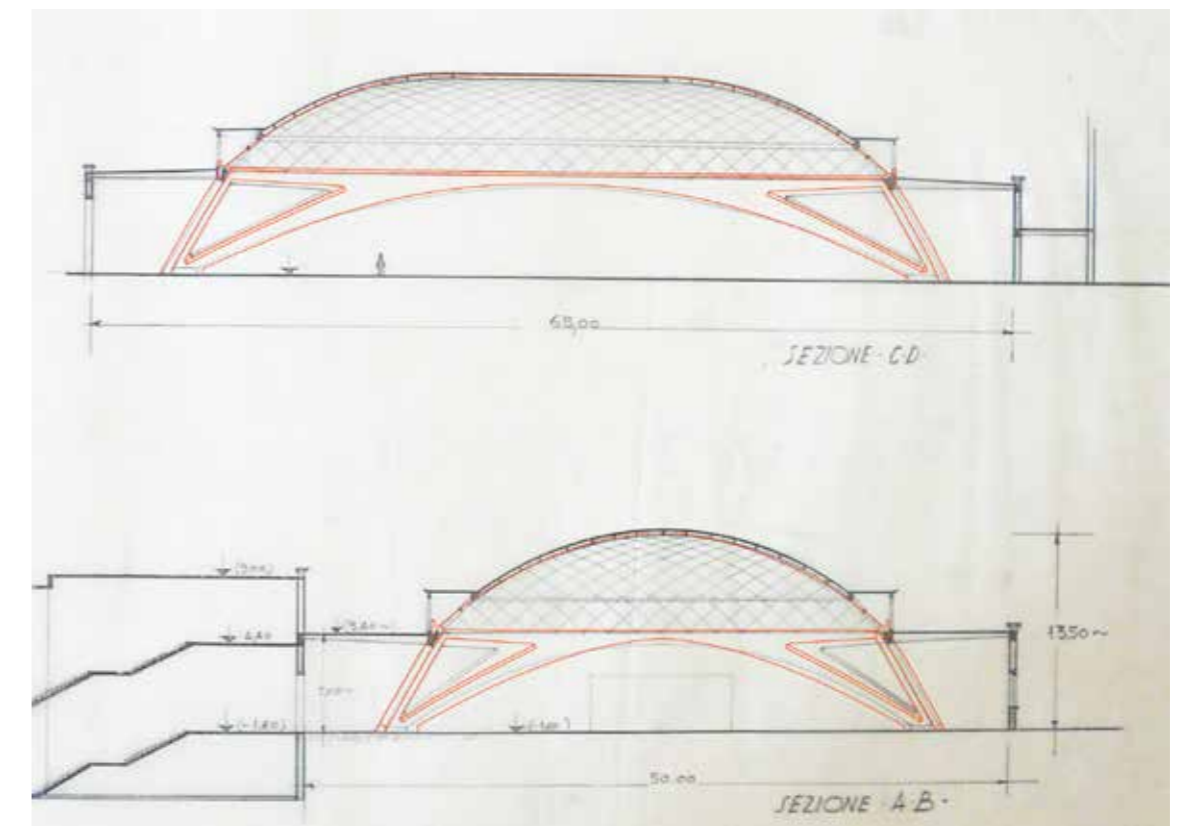

3b 1.15: Excerpt of the drawing no. 3075 (CSAC, Università di Parma, courtesy Fondation PLN Project) with the overlapped profiles of arches and vault of Figure Hall C taken from the LiDAR survey. They fit almost perfectly. (elab. S. Perri ad I. Cofano)

3b.2 Study of the geometry at the base of the ribs of the apse of Hall B

Another study of the generative geometries of the structures of the Turin Exhibition Center concerned the design of the ribs of the apse of Hall B. The point cloud of the LiDAR survey and its projections were carefully studied to identify the possible geometric constructions used by Nervi to conceive the domed structure made of ferrocement. One of Nervi's drawings of the apse ribs projection is conserved in the CSAC archive. However, it refers mainly to the projection of the final lozenge drawing to the dome (Figure 3b 2.1).

The geometric design that we developed first of all predicted this dome would be spherical (it ascertained Nervi inserted the radius at a later stage). A clear use of the most suitable procedures based on ICP algorithms that estimated the distance between the point cloud and the probable spherical surface provided the basis for the next generation after confirming the spherical generatrix. (Figure 3b 2.2 - 3b 2.3)



3b 2.1: An impressive zenith view of the dome of the apse of Hall B. (P.L. Nervi Projects archive)

According to our reconstruction, the design of the ribs involves the repeated use of arcs of appropriately ordered circumferences and with centers of curvature strictly belonging to concentric circles, starting from the hemisphere that constitutes the dome. Figure 3b 2.4 shows the phases of geometric tracing to reconstruct the ribs and relative lozenges in ferrocement:

Starting from the division into 3 portions of a quadrant, the geometric rhythm is based on the subsequent division into 9 and 18 parts of each quadrant, meaning, therefore, the construction is set on spherical rays with 10° and 5° sexagesimal angular steps.

The lozenges have straight sides depending on their location towards the key of the dome, or circular towards the springer. Their design and proportions are drawn from tracing concentric circles (parallels of the sphere) that intercept the meridians.

The geometric design of the ribs was preliminarily studied in 2D, followed by a radial and planar projection on to the sphere and on to the generating spheres. One projection was represented by the spherical surface of the lozenges and the other by the spherical surface of the ribs, to obtain modeling that showed very limited deviations from the actual building.

Compliance with a precise geometric construction of the ribs in plane projection enabled the interpolation of the latter on

the spherical surface to be optimized. The deviation analysis shown in figure 3b 2.5, guarantees a good estimation of the general precision, since the result states that for 70% of the points, the deviation between the ribs and the lozenges in ferrocement in-situ and those measured using terrestrial laser scanning is approximately 2 cm (which is very close to the accuracy of the 3D survey).

It is also quite surprising that the dome designed by Nervi had a sphere radius of 28.63 m, whereas the internal and external radius of the interpolated spheres taken from the 3D LiDAR survey is 28.58 m and 28.84 m, respectively.

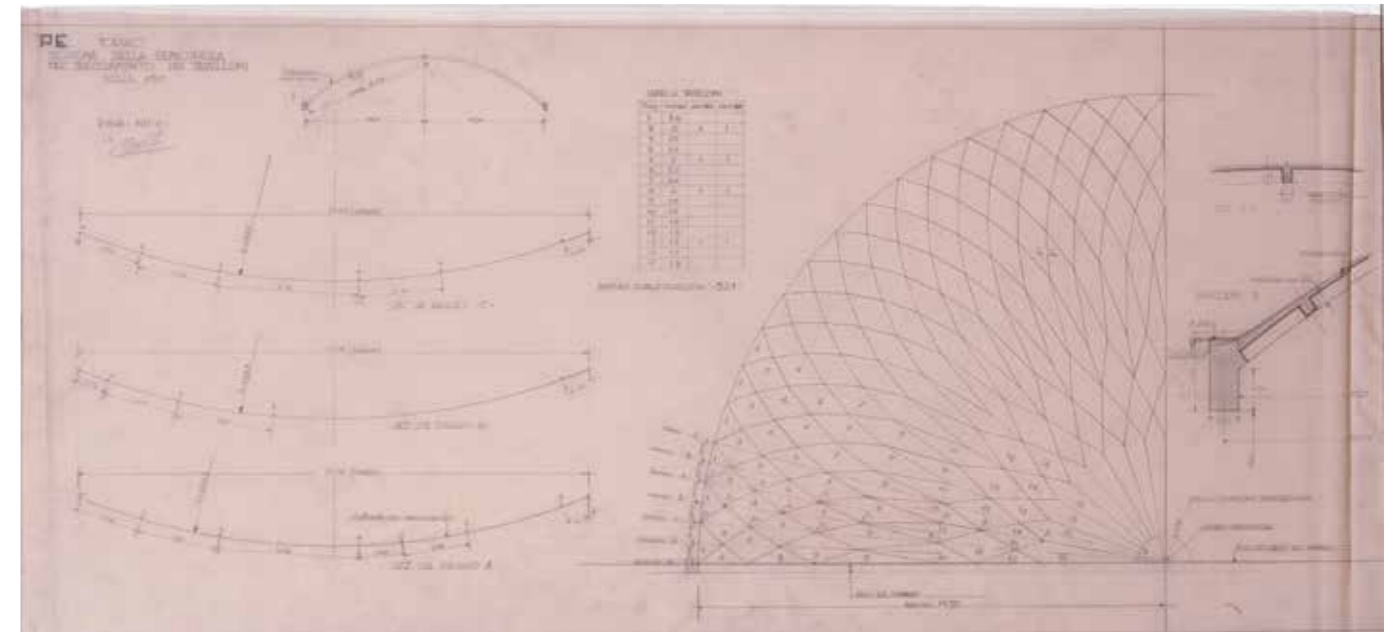

3b 2.2: Drawing n°. 2641 showing the rib design and their projection on to the dome using the half dome chord.

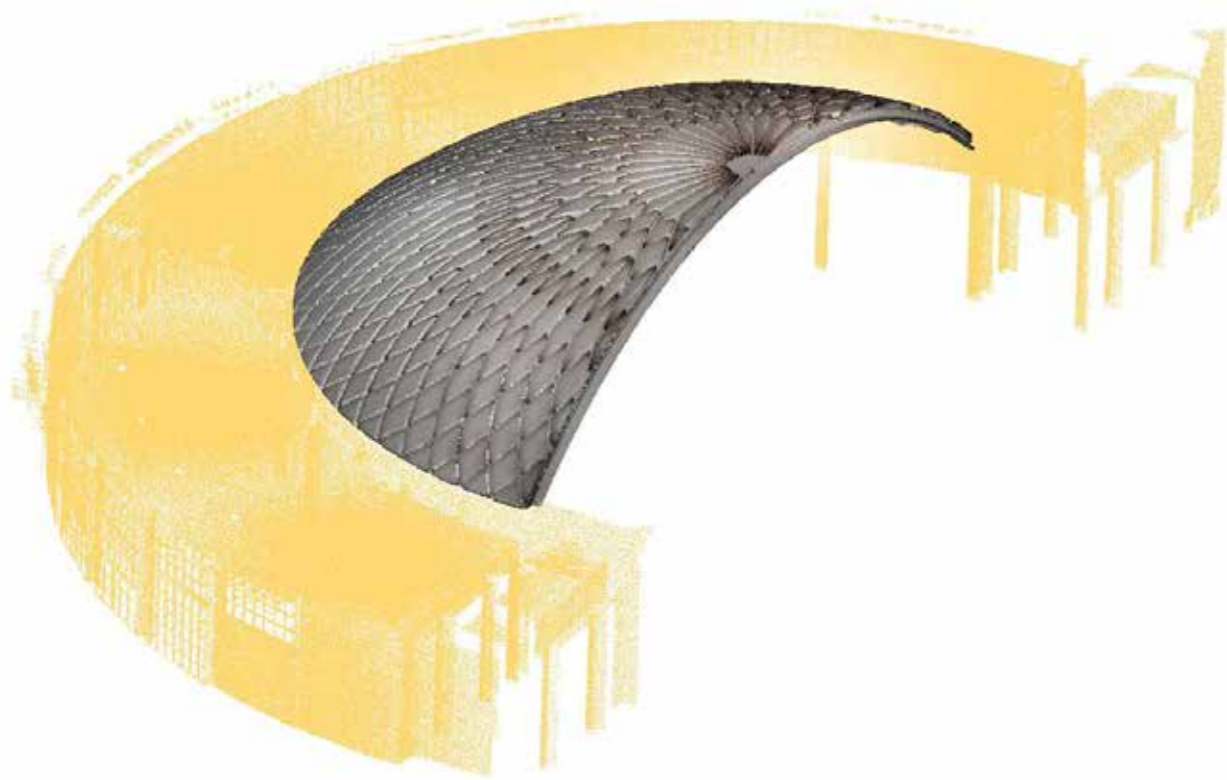

3b 2.3: LiDAR cloud of the apse of Hall B, highlighting the spherical dome studied. [Point cloud of the apse is segmented by the other components of the 3D model.]

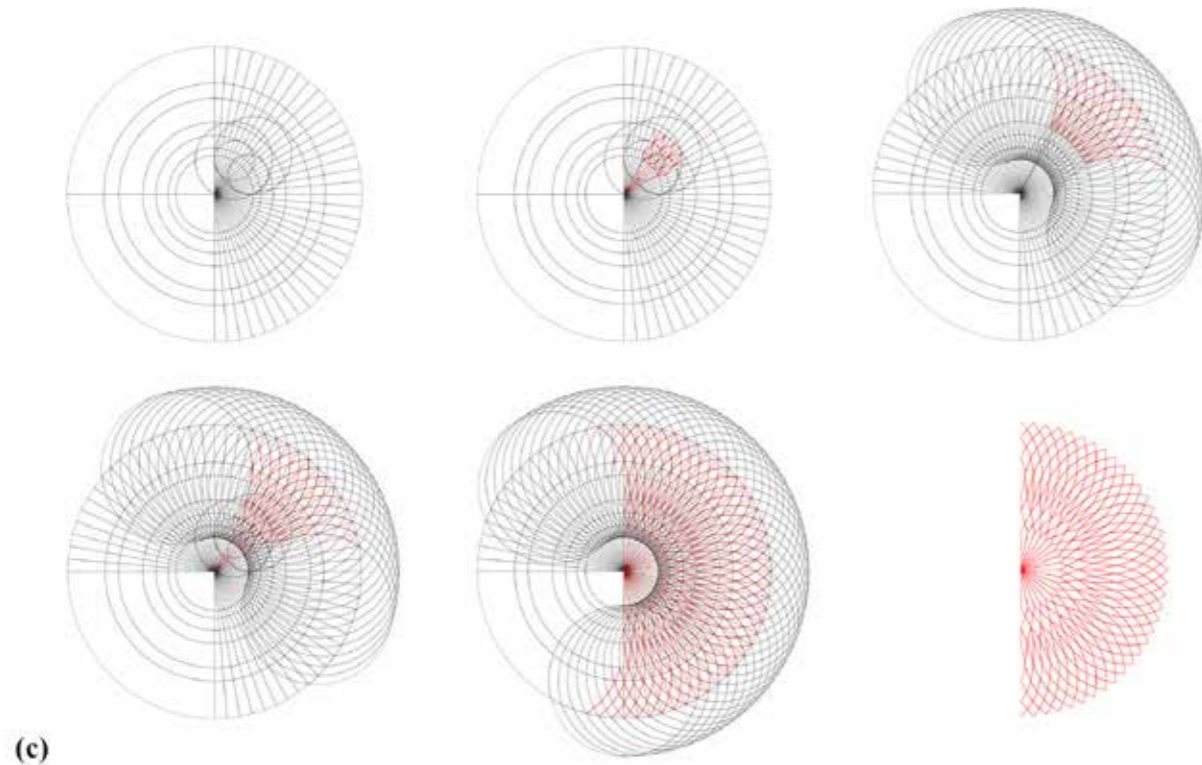

(c)

3b 2.4: Study to search for possible tracing geometries of the design of the apse ribs of Hall B.

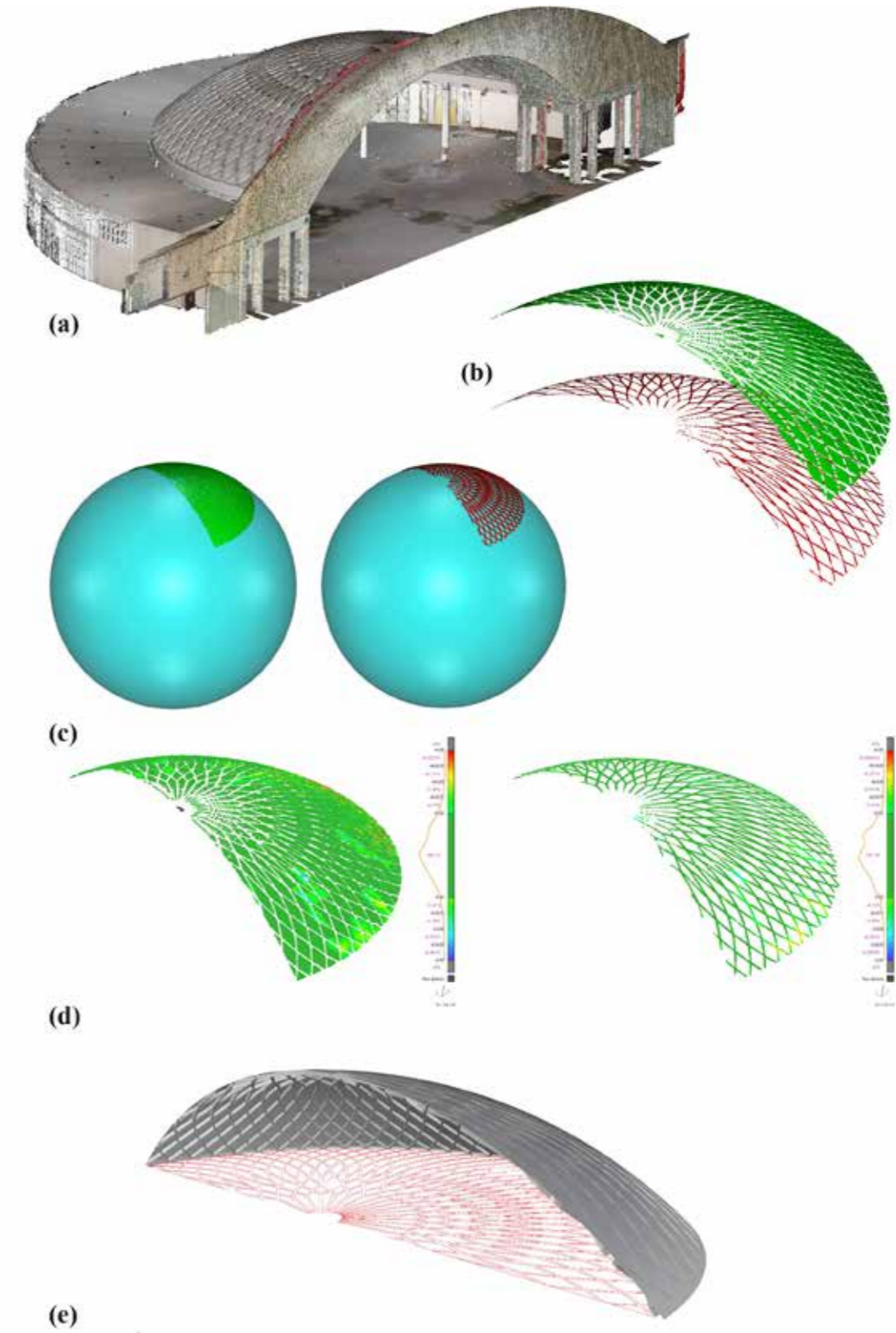

3b 2.5: Study for the definition of a process to extract generating geometries: a) Point cloud of the apse area of Hall B. b) Segmentation of the point cloud in the opaque intrados of the upper closure and ribs. c) Spheres adapted to the segmented surfaces from the cloud. d) Metric comparison between the segmented clouds of the apse vault and the mesh of the adapted spheres (90% deviation of less than 3 cm in both geometries). e) Modeling of the apse with the use of adapted spheres and the extrusion of the ribs from 2D data.