

A multicriteria decision aid perspective that guides an incremental development of knowledge and fosters relationships and decisions

Original

A multicriteria decision aid perspective that guides an incremental development of knowledge and fosters relationships and decisions / Curto, R.; Norese, M. F.; Rolando, D.. - In: EURO JOURNAL ON DECISION PROCESSES. - ISSN 2193-9438. - 10:(2022). [10.1016/j.ejdp.2022.100023]

Availability:

This version is available at: 11583/2980206 since: 2023-07-11T18:33:57Z

Publisher:

Elsevier

Published

DOI:10.1016/j.ejdp.2022.100023

Terms of use:

This article is made available under terms and conditions as specified in the corresponding bibliographic description in the repository

Publisher copyright

(Article begins on next page)



A multicriteria decision aid perspective that guides an incremental development of knowledge and fosters relationships and decisions

Rocco Curto^a, Maria Franca Norese^{b,*}, Diana Rolando^a

^a Department of Architecture and Design, Politecnico di Torino, Viale Mattioli 39, 10125 Torino, Italy

^b Department of Management and Production Engineering, Politecnico di Torino, Corso Duca degli Abruzzi 24, 10129 Torino, Italy

ARTICLE INFO

Keywords:

Decision aid process
Problem structuring methods
Strategic choice approach
ELECTRE methods
Ivrea UNESCO site

ABSTRACT

“Ivrea, industrial city of the 20th century”, is the 54th UNESCO site in Italy, and it has been in the World Heritage List since July 2018. Its inclusion was the result of a complex decision process, which needs to be reactivated to enhance this large, unitary urban system of great historical, architectural and environmental value. The huge dimensions and extreme heterogeneity of the built heritage, the weakness of the socio-economic context, and the dynamics of the public and private organisations have generated a complex situation, which hinders the enhancement of the whole UNESCO site. A methodology that integrates two decision aid approaches can deal with and reduce these complexity factors, to guide the incremental development of knowledge and to foster relationships that facilitate the process reactivation. A Problem Structuring method was used to structure the decision problems and logically synthesise fragmented knowledge. Multicriteria models and methods were used to analytically describe the space of action and propose examples of how alternative policies, enhancement activities or projects can be analysed and evaluated, to be ranked or selected. The paper describes the problem situation and how these methods were integrated and used. The study aims to underline the complementarity of the different decision aid approaches and to show how logical and analytical models, applications of tools and results can be proposed to create an effective communication process, both at technical level and with stakeholders who are willing to participate in preparatory workshops.

Introduction

Aiding a decision maker who has a real-life decision problem is a difficult and complex task. A decision aid process can develop in different ways, in relation to the state of the decision system and the main complexities of the decision problem, and models and methods can play different roles in such a process. Any decision system should include the decision makers and actors who are involved in a decision process, together with their value system and behaviour, as well as a decision structure that is formalised to some extent (actors' roles recognised by the involved organisations and specific rules to be implemented in the process). The formalisation level of the decision structure can be very limited, while different states can characterize the decision system. Six typological situations that result from combining the complexities of a problem situation and/or decision system were recognised and described in Norese (2016a). One of these (when a formal decision system has not yet been activated because the problem situation is new and unstructured) can be dealt with through knowledge elaboration and its use in exploratory workshops. Actors in decision processes related to a problem, who perceive the need to activate an innovative situation,

may be involved. The role of the models and methods in these problem situations is that of facilitating problem understanding, by means of a preliminary study, which includes structuring, modelling and the application of methods (Norese, 2020a). These activities and their results are used to clarify a complex situation and to propose a consistent approach for a decision process that has not yet been put into action.

The paper presents the description of a specific case, in order to propose some reflections on a decision aid methodology, which is oriented towards facilitating problem understanding and an incremental development and communication of knowledge in complex and risky situations that imply the involvement of public and private organisations in a decision system or, as in the analysed case, require the activation or reactivation of a formal decision process.

A long decision process involved several actors and led to the inclusion of the “Ivrea, industrial city of the 20th century” site in the UNESCO World Heritage List (WHL) in 2018. This is a precious opportunity for Ivrea and its territory, but also represents a risk, given the institutional constraints this insertion implies and the several uncertainties of a different nature about the enhancement and management of the site.

* Corresponding author.

E-mail address: maria.norese@polito.it (M.F. Norese).

Some ideas for the future redevelopment of the site have been presented and discussed in the last few years, but they mainly represent private initiatives related to single and non-interconnected projects. A decision system should propose a strategic vision of the enhancement and enjoyment of the whole site. However, such a system has not yet been formalised, even though the Municipality of Ivrea has clearly been recognised as a key decision maker and the coordinator of public and private actions. Some actors, who were involved in the decision process in the past, believe that the decision process needs to be reactivated to prevent the achieved results from being undermined.

One of these actors represented the Politecnico di Torino in the previous decision process and was also involved in other processes aimed at enhancing the area as well as in recent projects such as the “Smart Ivrea Project” and the activation of the new master in Behavioural Design¹. Therefore, the Politecnico di Torino may play a new and active role in aiding the Municipality of Ivrea in the site enhancement process, coherently with its third mission activities and on the basis of the past collaborations, and of the experience on the territory and knowledge gathered over the last few years. With this aim, the Politecnico di Torino became the client of this study in 2019. The authors of the paper, who worked together in this incremental development of knowledge, have different competences and played different roles. One of the authors is the stakeholder who represented the Politecnico during the candidacy process, as part of the third mission activities of the Politecnico di Torino, and therefore became the “client” of this study. Another of the authors is a decision aid analyst, who had not been involved in the previous process, and the third author is a decision aid analyst who knows all about the candidacy process because she had worked as an assistant in the investigation, data acquisition and use in the education activities, during the candidacy process.

The authors set up a research team in which knowledge about the previous process and the documents, which had been produced by the Politecnico and some other stakeholders, was shared. The main aims of the team were to organise, validate and synthesise the several and dispersed pieces of knowledge, and to translate them into a communication space, in order to aid the client in triggering a new decision process.

Such a study was required and conducted to facilitate and foster a public approach to the enhancement of the site by applying the methodology set up by the research team, at the technical level, and by proposing a systematic and overall vision of the problem situation through exploratory workshops with the Municipality and the potential actors involved by the Municipality.

The methodology is based on an agile integration of two complementary decision aid approaches, to logically and analytically describe and propose a collective and incremental analysis on how effectiveness and efficiency can be evaluated, together with the risks that may be associated with alternative policies, operational scenarios and/or projects.

The main aim of the study was to organise and communicate knowledge that could facilitate the Municipality of Ivrea in the process reactivation, while one of the methodological aims of the study was to test the agile logic of an incremental development and validation of knowledge that the integrated decision aid methodology would propose.

The first section of the paper proposes a description of the problem, the nature and role of the actors involved in the first phase of the decision process and the complexity of the present situation, which led to the decision process being stopped. The second section presents details of the integrated methodology. The third section shows how it was applied, from a technical point of view, by the research team, and the fourth indicates how some results were presented in online meetings, to

test the assumptions that were at the base of the technical approach to the decision problems and the communicative and explicative value of the results, and to discuss, validate or improve the acquired knowledge. Some reflections on the difficulties that have arisen pertaining to the presentation and discussion of the logic and results of this decision aid methodology, on its present and potential role and on its future developments are presented in the Conclusions.

1. The Ivrea UNESCO site and its enhancement

“Ivrea, industrial city of the 20th century”, is the 54th UNESCO site in Italy, and it has been in the WHL since July 2018. It is a large urban area in the city of Ivrea, developed under the leadership of the industrialist, planner and social reformer Adriano Olivetti during the XX century, in order to both expand his eponymous typewriter company and to create a model of a modern industrial city.

The exceptional value of this site has been well synthesised by the World Heritage Committee who, on the one hand, highlighted the outstanding architectural quality of the buildings - more than 100 valuable examples of Modern Heritage - and on the other, the influence that the cultural and political Community Movement (Olivetti, 1945) has had on the setting up of the entire urban system.

The candidacy to include this heritage in the UNESCO WHL was decided on in 2008, the year of the Centenary celebrations of the start of the Olivetti Company.

The Adriano Olivetti Foundation, in collaboration with the Municipality of Ivrea and the Politecnico di Milano, promoted the creation of a National Committee, which was established by the Italian Ministerial Decree of March 20, 2008 and financed by the Ministry for Cultural Heritage and Activities and Tourism (MIBACT), the Piedmont Region and the Adriano Olivetti Foundation. This Committee collaborated with MIBACT and some national and international experts and, in 2012, the site was included in the Italian Tentative List of UNESCO candidate sites. In 2012, the UNESCO World Heritage Office of MIBACT set up a Steering Committee (including the Municipalities of Ivrea and Banchette, the Adriano Olivetti Foundation, the Guelpa Foundation, the Piedmont Region and the Metropolitan City of Turin)², which worked for four years to prepare the Application Dossier and Management Plan. The Italian State submitted these documents to the UNESCO World Heritage Office, which verified their completeness, and ICOMOS, a UNESCO advisory body, began the evaluation process in 2017. In 2017, the Steering Committee was also supported by the Politecnico di Torino, as a result of ICOMOS requesting additional data and information to complete the evaluation process. The UNESCO World Heritage Committee officially included “Ivrea industrial city of the XX century” in the WHL on July 1st 2018.

This strategic result was achieved as a result of the great effort of the Management Operating Structure of the Steering Committee (composed of a Coordinator and the General Secretary of the Municipality of Ivrea), which was supported by a Technical Advisory Board (see the Management Plan, pp. 39-41, in the [Municipality of Ivrea and Adriano Olivetti Foundation, 2012](#)). The General Secretary of the Municipality of Ivrea coordinated all the municipality departments involved in delivering the Actions organised by the Municipality. The functions of the Steering Committee were: to maintain contact with UNESCO and the external organisations; to coordinate the information flow between the involved actors and the main partners; to be in charge of the actions in which the Steering Committee was the Project leader (or in which the leadership was shared with another partner); to monitor the partners’

¹ See the three sources, <https://www.agid.gov.it/agenzia/stampa-e-comunicazione/notizie/2020/01/10/al-smart-ivrea-project> - https://poliflash.polito.it/in_ateneo/il_politecnico_partecipa_al_progetto_smart_ivrea_project and https://poliflash.polito.it/studenti_polito/presentato_il_master_in_behavioural_design.

² Other bodies were included to integrate the Steering Committee: the Superintendence of Archaeology, Fine Arts and Landscape for the Metropolitan City of Turin; the Regional Secretariat of MIBACT for Piedmont; the General Directorate for Architecture and Contemporary Art and Associated Organisations; private partners and owners or managers of the assets; cultural institutes of national relevance.

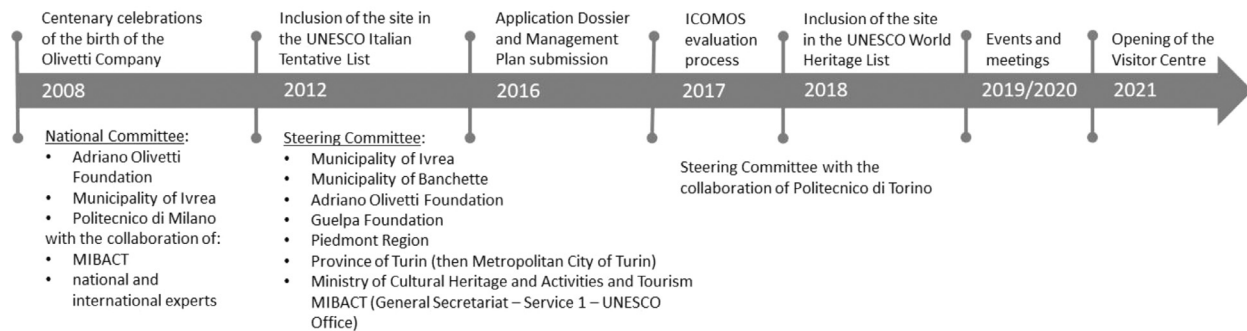

Fig. 1. The decision process 2008-2018 and the new activities.

work in implementing the actions in the Management Plan; to organise and coordinate any Technical Advisory Board activities. The Politecnico di Torino had not been a technical adviser during the application to the WHL phase but rather a stakeholder that supported the Municipality of Ivrea by proposing enhancement projects developed in education contexts and by sharing data elaboration results to foster the candidacy process.

In 2018 the Administration of the Ivrea Municipality changed after the municipal elections. After the inclusion of the site in the WHL, some private projects were presented in 2019 and 2020, such as the ICONA project related to the redevelopment of a part of the Olivetti former factory in the headquarter of a business cooperative. The Municipality of Ivrea on the one hand interacted with the private owners of the assets in order to be constantly informed and updated; on the other hand, it promoted the UNESCO site by organizing some events. The principal occasions were the installation of the UNESCO plate (June 2019) and, in September 2020, the first edition of the architecture festival “Design For The Next Community”. In July 2021, the Municipality of Ivrea opened the visitor centre of the UNESCO site, which is currently organizing some guided tours around the site (see Fig. 1).

1.1. The complexity of the problem situation

The UNESCO site includes several buildings with huge underused spaces (the former Olivetti factory and its services), which require redevelopment interventions before they can be oriented towards a specific use, and public and private spaces (such as residential buildings and a public kindergarten) whose final use cannot be changed. The outstanding architectural quality of all the buildings, the constraints that the Archaeology, Fine Arts and Landscape Superintendence have imposed and the surprisingly large dimensions of several buildings make any project complex, and whatever project is chosen will need an overall financial plan for the short, medium and long term.

In a general scenario of very limited or absent public resources, at least at a local level, the possible sources of funding are the State, foundations and private enterprises. However, the economic crisis and the vulnerable socio economic context in which the site is located (decreasing population, weak real-estate market) do not foster high profitability and increase the investment risk level, thereby reducing the possibility of private enterprises taking part. Moreover, the redevelopment strategies activated by the different private owners of the assets need to be monitored, and their possible interdependencies and different visions of the site enhancement process need to be coordinated.

The redevelopment and economic enhancement of this valuable example of industrial city is a complex process that is characterised by several decision problems (in relation to the public and private resources that can be used to redevelop, enhance and exploit the site, and to the specific use of these resources) and uncertainties of a different nature (What are the strategies proposed by the owners of the assets? Who are the actors that were involved in the past and/or have a strategic role

today or should be involved in the future? How can Olivetti’s intangible legacy be communicated, enhanced and exploited? etc.). Moreover, the COVID-19 emergency has increased all these complexities and uncertainties.

The role of the Municipality of Ivrea has been central until the site was included in the UNESCO WHL, but it should continue to be central in the future, in order to implement the Management Plan the Steering Committee had prepared and presented (see Fig. 1), to comply with the requests from the World Heritage Committee (2018) and to put innovative governance strategies into practice. Currently, although the redevelopment of the site represents a huge challenge for the Municipality of Ivrea, which has been called upon to achieve emblematic goals by the beginning of 2023 (i.e. before the next elections take place), the decision process that started in 2008 seems to have stopped in 2018, when the site was included in the UNESCO WHL.

Despite the organization of some events, to promote the site, and the opening of the Visitor Centre, a decision structure has not yet been activated by the Municipality of Ivrea. As mentioned in the local newspaper *La Sentinella* on 10th of June 2019, the Mayor of the Municipality of Ivrea had spoken about the necessity of setting up a foundation to manage the site, but, at that date, the implementation times and the involved actors had not been decided on. The situation has not changed. The Steering Committee members who were entrusted with the inclusion of the site in the UNESCO WHL (Fig. 1) play an undefined role. Moreover, some local processes of private organisations, who are the owners of the assets and have different goals and development strategies, are developing without a systematic or overall vision of the actual situation of the site. For example, the Olivetti Historical Archive is planning to move its headquarters to another building located in the UNESCO site and an important Italian Foundation (FAI - Fondo Ambiente Italiano) is planning the opening of a new Museum dedicated to the Olivetti Family.

Therefore, a decision structure that takes on a public perspective has to be activated to coordinate and integrate partnerships, ongoing projects and existing networks, and to foster the enjoyment of the territory. A great number of public and private organisations could be involved in the process at different levels, with different relationships and possible roles in the new phase of the decision process and, in some cases, with knowledge of the previous phase. Fig. 2 describes a possible structure for the institutional roles and organisations that are directly connected to the problem. The Politecnico di Torino was one of the cultural institutions that had been involved in the previous decision process. The site was studied as a case study in a Master of Science course in “Architecture for Heritage preservation and enhancement” for some years, and the Local Administration was involved in education activities that modelled and proposed ideas for the enhancement of the site (Curto et al. 2021). Data and knowledge, which had been acquired in this period of time, were used to support the final evaluation of the candidacy proposal of the UNESCO site, before its nomination.

Two years after the inclusion of the site in the WHL, the new administration had only partially activated the site enhancement steps that

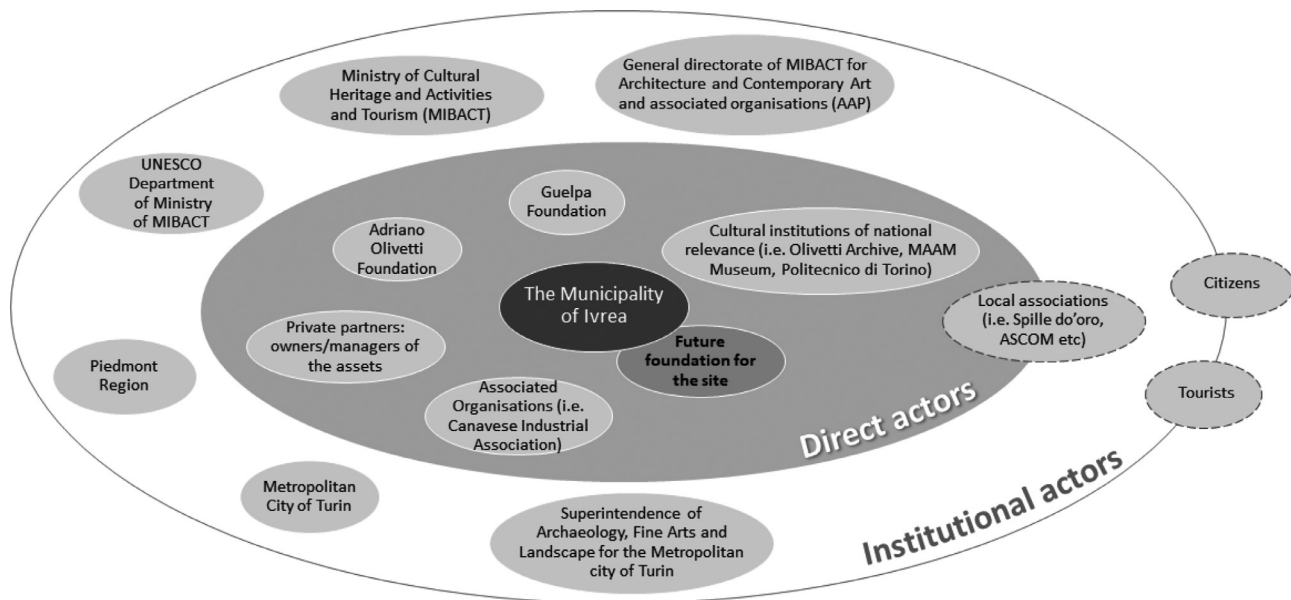

Fig. 2. Actor structure.

had been specifically required in the document containing the decisions adopted during the 42nd session of the World Heritage Committee (Manama, 2018).

This situation motivated the Politecnico to propose its competences to the new administration and to undertake a new initiative that could activate a debate on "what to do now" with all the documents and elements of knowledge that had been produced during the education activities and discussed with the local administration during the previous process.

Therefore, a specific methodological approach was generated to integrate different quantitative and qualitative elements of knowledge in the description of the site enhancement problem, and to involve the Municipality of Ivrea, some of the actors that had been involved in the previous process (above all the Adriano Olivetti Foundation) and some potential new actors in informal preparatory workshops, to generate an overall vision of the situation and its complexities, and to discuss possible scenarios and operation approaches. In this way, the Municipality of Ivrea would have been in a position to define the decision structure of the involved actors and activate a formal decision process.

2. An integrated decision aid methodology

This decision aid methodology is based on the agile and integrated use of a Problem Structuring Method (PSM) with multicriteria (MC) models, methods and SW tools, at two different levels: a technical one, where only the technical team is involved and needs a structured context to identify and validate the essential elements of the problem and a simple vehicle for communication, and a participative level, where the team presents its technical results in meetings and workshops that involve some stakeholders, to facilitate communication between the participants, expression of opinions, criticisms and values, discussion and improvement of the results.

The technical steps of the methodology are developed to distinguish the main components of the decision problem, to incrementally structure them and to elaborate, logically describe and analytically evaluate easy-to-visualise future scenarios. These steps imply a trial and error approach that uses logical contradictions or the evident pointlessness of a step and its results to control the course of action. A collective result analysis, at a participative level, should make the points of view and values of the participants evident, and often sufficiently relevant to ac-

tivate new technical steps that update the achieved results, and so on (Fig. 3).

Ill-structured problems require specific emphasis on the activities of conceptualisation and problem specification, which lead to a good correspondence between the problem situation and its empirically supported model. Several involved factors are connected to economic and technical dimensions, but also to social, organisational and political ones. Multiple actors and perspectives, competitive or conflicting interests, constraints and uncertainties can generate what Rosenhead and Mingers (2001) defined as "an unstructured problem". PSMs can actively support public authorities during the preliminary analysis of a political action, when decision-making processes have to be activated, decision problems have to be structured and technical and/or organisational solutions have to be developed (Rosenhead, 1989; Mingers and Rosenhead, 2004; White, 2009).

An MC model can be considered as an evolving system that is based on different elements, and in particular on the statement of a decision problem, a complete set of possible actions and a family of coherent criteria, which can change during the modelling process. The model should include all the points of view concerning the problem, and its structure should be simple, easily understandable and rigorous (Roy, 1990a; Bouyssou, 1990). The possibility of dealing with all kinds of qualitative and quantitative data and technical evaluations from different fields, without changing their languages, and then choosing an MC method, which is consistent with the nature of the data and action evaluation, rules out the need for a great deal of descriptive, interpretative and communication constraints.

Some procedures can support structuring and MC modelling, when complexity and uncertainty are not so high and/or the problem is at least partially structured (Norese, 1996; 2020b). If the request is not clearly structured, above all when the problem situation is new and information, knowledge and previous procedures do not exist, Multiple Criteria Decision Analysis (MCDA) methods are often combined with PSMs (see Belton and Stewart, 2010 and the review by Marttunen and Liener, 2017) that allow the problem to be seen and analysed in its total context, clarified and structured. The sequence, of an MCDA application after the structuring contribution of a PSM, produces interesting results (see, for instance, Belton et al., 1997; Bana e Costa et al., 1999; Montibeller et al., 2008; Stewart et al., 2010; Ferreira et al., 2011).

The proposed methodology implies a different and agile integration of MCDA and of a PSM, where the passages from conceptual to logical

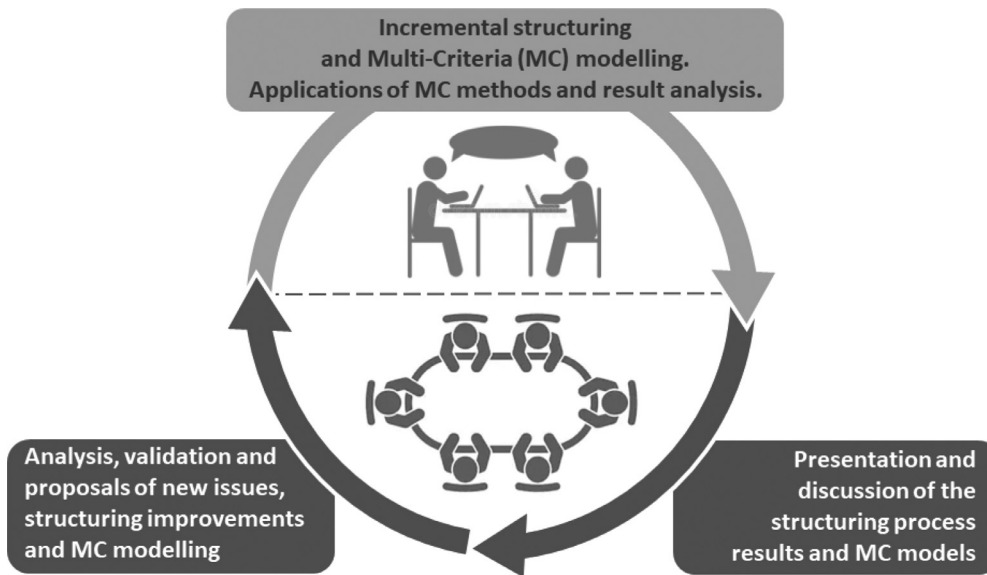

Fig. 3. The agile logic of the integrated methodology of decision aiding.

and analytical models are continuous and incremental, and a collective analysis of the MCDA results generates inputs for a PSM and vice versa.

An integration of a multicriteria approach and a specific PSM, the Strategic Choice Approach (SCA), takes advantage of a logical parallelism between the two approaches, which adopt the same logical concepts, in addition of their different potentialities, and underlines the complementarity of these approaches (Norese et al., 2004, 2008). In SCA, a decision is made difficult or impossible by uncertainties of a different nature, which have to be identified, analysed and reduced or eliminated. Uncertainties about the values are basic elements of both SCA and MCDA, but SCA distinguishes these uncertainties from other kinds of uncertainty that may be present in complex situations and which need to be identified and analysed in depth. SCA generates inputs for MCDA, and MCDA synthesises concepts from SCA, in simple, transparent and formal analytical models that facilitate communication and decision making. MC models, and the results of the applications of MC methods, are easily presented and discussed in collective contexts, and they produce reactions that can be analysed and used with SCA and its tools. Therefore, the agile logic of this integrated methodology of decision aiding is aimed at creating a communication and organisational learning process, which is firstly developed in a technical team and then in a close synergy with stakeholders.

The SCA methodology is used in general to facilitate decision makers in structuring complex problems, but it can also be useful when a decision system has not yet been defined, the potential actors have no knowledge of the problem situation and their values have not been defined. Bringing these values to the consciousness of the participants was the main aim of the SCA in this situation (Norese et al., 2015). In the proposed methodological approach, the SCA is above all oriented to integrating and visualising knowledge that exists but is fragmented, while MCDA is not used to aid decision makers but instead to describe how this integrated knowledge can be operationally used, and to stimulate the potential actors to collaborate in a new process.

2.1. The Strategic Choice Approach (SCA) and Strategic Adviser (STRAD) software tool

SCA (Friend and Jessops, 1969; Friend, 1989) is normally used to structure problems characterised by a high level of uncertainty with several interconnected decisions, to explicitly manage and reduce complexity, control uncertainties, exclude alternatives that are not feasible for technical or political reasons, and elaborate and compare compatible

solutions. The SCA methodology, with the support of its STRAD software tool (Friend, 2002), has been applied in various situations (see, for instance, Han and Laiò, 2011; Rolando, 2015; Georgiou et al., 2019; Paucar-Caceres et al., 2019).

SCA is based on an open and flexible process that includes four complementary operation modes, Shaping, Designing, Comparing and Choosing, which can be used in multiple sequences. Its structuring process proposes a continuous moving from one to another *area of action* (of uncertainty or decision analysis, or of comparing options, alternatives or schemes), which is open and flexible but oriented by a sequence of structured and structuring tools. Alternatives and values are always present in each SCA operation mode, and the reduction and control of uncertainty and complexity facilitates the expression of strategic objectives and evaluation criteria.

STRAD, the SW tool of SCA, facilitates a visualisation of the main complexity elements that characterise a decision problem and its sub-problems (shaping), of the combinatorial elaboration of alternative decision schemes and their mutual compatibility verification (designing), and of a logical comparison that facilitates selection and choice.

The Overview window (see Fig. 4) is a synthetic and visual guideline that STRAD uses to include the main aspects of the decision problem. The elements that make decisions very difficult, or impossible, are listed on the right side of the window in Uncertainty Areas (UAs), and are visualised around the Focus (the central circle), in relation to their different nature (UV- Uncertainty about the guiding Values that should orient a clear path, but which are not made explicit, UR - about Related choices and UE - about the working Environment). Their identification, explicit formulation and classification is the first step of the SCA approach, and it is aimed at reducing, or at least controlling, these critical elements.

The Design mode of SCA reduces the complexity of the problem and facilitates the elaboration of some possible actions, which should be analysed and discussed. The interconnected decisions, formulated as Decision Areas (DAs), and associated with all the possible decision options, are listed on the left side of the window. A few DAs, which are the expressions of the most urgent and interconnected decisions, are placed in the Focus section, to be analysed in order to verify the compatibility of the options and to select compatible schemes of action. If the number of DAs is high, some of them are dealt with at each iteration of the SCA methodology.

The Comparison areas, listed at the bottom of the window, are generated during the SCA application to express comparative judgements, select “interesting” schemes of action and/or to eliminate those that are

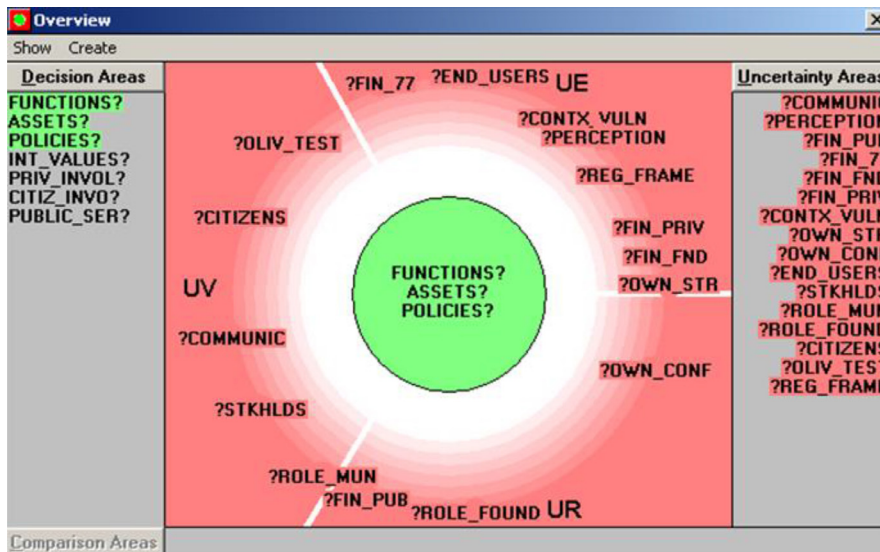

Fig. 4. Overview window (Source: Elaborated by the Authors by means of the STRAD SW tool).

evidently not viable. The Comparing mode, with its conceptual identification and use of points of view and values, facilitates the definition of formal expressions of judgement, that is, of specific objectives and criteria that can be used to analytically evaluate actions and to apply MCDA methods.

2.2. Multicriteria models and methods in the integrated methodology

An MC model is defined in relation to a specific need, problem statement or goal, and to the nature of the possible actions (Roy, 1990b, 1996), which may be detailed activities or projects, or conceptual solutions, programmes, plans, future scenarios, etc. An analytical model allows any single action to be evaluated in relation to a family of coherent criteria. Parameters are introduced into this model to express the preference system of the decision maker(s).

In this integrated methodology, analytical models describe how knowledge elements can be used to evaluate actions in relation to the problem situation. The models are generated to test quality, completeness and usability of the available knowledge. The parameters are introduced from a technical point of view, by way of example, to document and logically explain their meanings and roles in the model. Only at the participative level, when the analyst presents an MC model in a meeting, model structure and parameters are collectively analysed, discussed and changed, or their weakness stimulates a new SCA analysis.

Several different MC methods have been proposed in literature (see, for instance, Ehrgott et al., 2010; Greco et al., 2016) and the method should be chosen in relation to the nature of the decision process and possible actions, and to the different needs and goals that are associated with the answers (Roy and Słowiński, 2013). The MC Outranking methods of the ELECTRE family are proposed in the integrated methodology to synthesise the results of the action comparisons in relation to criteria that can be associated with qualitative or quantitative evaluations (Roy, 1990b; Figueira et al., 2005). The structures and contents of the MC models depend on the different decisional and informational situations, and the necessary parameters of each model are defined in relation to the methods that have to be used.

In the integrated methodology, when the most interesting decision schemes, which an application of SCA has generated and selected, become the actions in MC models, their number is in general not so high, and they are expressions of almost homogenous logical situations. In general, detailed data are not present in such “conceptual” situations and their acquisition is not so easy. The goal of MCDA may be to evaluate and compare such homogenous actions, and rank them in terms of risk, quality, effectiveness, or urgency of a decision and its imple-

mentation, etc. In this case, the application of the ELECTRE II method (Roy and Bertier, 1973) is appropriate, if the judgements expressed in the SCA application become a prerequisite to generate a set of “good” ordinal scales, which are associated with the criteria of an MC model.

If the actions to be analysed pertain to all the possible schemes of action that result to be technically compatible in the SCA application, their number may be very high and the nature of the actions may be different, and therefore the actions may be incomparable. The application of the ELECTRE Tri method (Roy and Bouyssou, 1993; Yu, 1992) seems appropriate in this case. It avoids the need of a direct comparison of actions of a different nature, which instead are compared with a reference system that expresses policies, standards or expectations, and are then assigned to categories (of risk, adequacy, effectiveness, control need, etc....) that produce a clear and organised vision of all the actions (and in this problem situation facilitate the definition of a Master Plan).

If the actions are actual projects pertaining to the local processes and strategies of private organisations, with detailed descriptions and a great number of technical and economic analyses of the proponents, they have to be analysed at a participative level, in relation to all the values and preferences of the workshop participants. In this case, an application of the ELECTRE III method (Roy, 1978, 1996) is the best choice, because it accepts any kind of criterion, with different levels of uncertainty associated with the evaluations, and a system of thresholds reduces the negative impact of the uncertainties on the result.

2.3. Creation of a communication and organisational learning process

A communication and organisational learning process is generated by this methodological approach, first in the technical team and then in meetings with the client and informal workshops with the stakeholders, during which a decision aid analyst presents and discusses the elements of knowledge that the technical use of decision aid tools produced. Therefore, the participants are guided by the analyst in these communication processes: to explore the nature of the decision problems and distinguish and clearly recognise their main components; to understand why some decisions would be difficult or impossible; to recognise which actions would have to be made urgently and which could be postponed, because they would not hinder the activation of the decision process; to identify or elaborate alternative strategies, courses of actions and/or specific projects; to express opinions, judgements, values and preferences.

The participants have not any role in a decision system that formally does not exist. But they can contribute to the discussion, clarify their positions and propose a different participation in a decision process.

Any topic of the discussion aims to define, analyse and model operational scenarios, and to reduce possible linguistic uncertainties. Models and methods can produce an effective description of the whole decision problem when a few technical terms are translated into a figurative and easy-to-understand language (Norese, 2016b). Any topic of the discussion can be updated or modified in relation with the opinions, judgements, values and preferences expressed at the participative level. New alternative decisions can be elaborated, evaluated and compared by means of analytical methods and any collectively analysed new result can generate new models or new topics of discussion and problem structuring steps.

Any structured topic of the presentations and collective discussions may be a stimulus for organisational learning, identification of complexities and uncertainties, clarification of misunderstandings, conflict control and activation of effective relationships between stakeholders and analysts or experts.

3. Application of the decision aid methodology

The methodology was applied at the Politecnico di Torino, by an interdisciplinary research team, to answer a request for the organisation of several quantitative and qualitative pieces of knowledge as a “result” that would be ready for use. The client, who had represented the Politecnico di Torino in the process of inserting the Ivrea site into the UNESCO WHL, shared data, site enhancement ideas and the associated risks and costs with the research team, in order to facilitate the Ivrea Municipality in activating the whole Ivrea UNESCO site enhancement process.

The enhancement of this particular site (one of the few “industrial” UNESCO sites in Italy) will imply several decisions as well as their funding and implementation, i.e. complicated actions that only a decision system could activate (with decision makers, a decision structure, rules and formal relationships with the other actors in the decision process). This system had not been activated when the client solicited a specific modelling approach, and the client’s main motivation was to facilitate the activation of a decision system to enhance the site.

The research team logically and analytically described the problem situation related to the enhancement and future enjoyment of the site. The description was validated, from a technical point of view, and tested, and it was found to be easily usable in a communication process. Some identified uncertainties, which could have made decisions difficult or impossible, were reduced by the acquisition and inclusion of data in a GIS system. Others were analysed and associated with specific scenarios. Possible enhancement activities were identified and evaluated, on the basis of data and knowledge elements that resulted from a structured analysis, in relation to some identified scenarios of risk.

A round-table meeting was then proposed to involve the Municipality of Ivrea and its interlocutors in the site enhancement, to describe the integrated use of the logical, analytical and visual tools, and to discuss the preliminary results. However, the COVID-19 emergency and post emergency led to any meeting being cancelled. A new communication process was later organised in 2020 and involved the research team, client and Municipality of Ivrea in online meetings.

The results of a recursive application of SCA and STRAD were presented, pointing out:

- the numerous UAs that had generated the complexity of the problem situation;
- the interconnections between the main Decision Areas (DAs) and a compatibility analysis between options of different DAs;
- the comparisons of courses of actions, options and schemes of action in the Comparison Areas (CAs).

These structured elements were synthesised in some problem situations and MC models facilitated their visualisations in the presentations. MC methods were applied to associate possible answers to the modelled decision problems. MC models and results of the method applications

Table 1
Uncertainty Areas

Code	Uncertainty Area	Typology	Explorative/action
REG_FRAME	Constraints from the regulatory framework	UE	Investigation
CONTX_VULN	Vulnerability of the socio-economic and territorial context	UE	Investigation
PERCEPTION	What is the perception of the site in Italy and abroad?	UE	Investigation
END_USERS	Number, profiles and needs of the future tourists/end-users	UE	UNESCO sites
COMMUNIC	How is it possible to effectively communicate the great relevance of the tangible built heritage and intangible Cultural Heritage?	UR/UV/UE	????
STKHILDS	Roles of public and private stakeholders in the future	UV/UR	Scenarios generation
ROLE_MUN	Role (responsibility) of the Municipality of Ivrea	UV/UR	Scenarios generation
ROLE_FOUND	Responsibility of the foundation that will manage the UNESCO site	UV/UR	Scenarios generation
CITIZENS	Citizen involvement and/or participation in the new process phase	UV/UR	Scenarios generation
OLIV_TEST	Involvement of those who are representative of Olivetti's values and memories	UV/UR	Scenarios generation
OWN_STR	Strategies proposed/activated by the owners of the assets	UR/UE	Press review analysis
OWN_CONF	Possible conflicts with the owners of the assets	UR/UE	Investigation
FIN_PUB	Is public funding possible?	UE/UV	Investigation
FIN_77	Can L.77/2006 be used to preserve and exploit the UNESCO sites?	UE/UV	Investigation
FIN_FND	Funds from private foundations	UE/UV	Investigation
FIN_PRIV	Funds/investments from companies	UE/UV	Investigation

were proposed as examples, to describe how enhancement policies, activities or projects can be evaluated and the results analysed and discussed.

3.1. The main elements of complexity and the most urgent decisions

The first important result was the identification of numerous UAs (see Table 1) that oriented the first activities and the other structuring steps. Some of them were classified as UEs, and they stimulated investigations to acquire data, information and/or knowledge. An integrated GIS was implemented, to include the data that had been collected during the Master of science courses at the Politecnico di Torino (data and a prototype for a GIS are described in Barreca et al., 2017 and Curto et al., 2018), as well as the results of new investigations about the site and its territory. Knowledge about the vulnerable socio-economic context was progressively acquired and integrated in the GIS, together with some important aspects, such as the residents' education, employment and income levels, the population growth trends, the real-estate market values, the physical accessibility to the site from its territory and from outside the territory, as well as the state of the equipped public spaces for citizens and tourists (see Barreca et al., 2020).

Some other uncertainties indicated that aspects of two different typologies were present simultaneously. UR indicates the need to at least know the decision constraints that some potential actors could generate, if they are not involved in the decision process. This uncertainty component could be eliminated by informal preparatory workshops. The UV component implies that values can be different or shared, but only their explicit declaration can orient a decision consistently. Therefore, the definition of some operational scenarios, in relation to the most probable actions or decisions, was considered consistent with the technical steps of the methodology, while an analysis of the space of action and of the values of the potential actors was associated with the participated steps.

The most critical element, which was considered the core of the problem, is "How is it possible to effectively communicate the great relevance of the tangible built heritage and intangible Cultural Heritage?" This uncertainty underlined the need of a public perspective in the identification of some DAs, to deal with this critical uncertainty. Three DAs - in the central circle of the Overview window in Fig. 4 - were considered closely interrelated and urgent: "Where is it possible to intervene first on the site? (ASSETS)", "What are the FUNCTIONS that can enhance the whole site?" and "What are the main POLICIES that the Municipality of Ivrea may adopt to improve the attractiveness of the UNESCO site and to increase the current visitor numbers?". Another DA, "What intangible values (INT_VALUES) have to be communicated, together with the tangible ones?", was then included in the aspects that were analysed in depth.

The analysis of other DAs (see in the box on the left in Fig. 4) - such as, "How can the private owners of the assets be involved? (PRIV_INVOL)", "How can citizens be involved? (CITIZ_INVOL)" and "Which public services in the site could be appreciated by Ivrea's population and visitors? (PUBLIC_SER)" - was postponed to the non-technical stage, with the Municipality participation.

3.2. The identification of decision options and their compatibility analysis

Some alternative options were identified for the most urgent DAs and then combined, in the Designing mode of SCA, to verify their mutual "technical" compatibility. A verification of their "political" compatibility was considered an objective of the participated level of analysis.

Different FUNCTIONS could be hypothesised as being appropriate for the buildings and the public spaces of the UNESCO site. In order to simplify the analysis, only three typologies (Business, Social and Cultural and Leisure) were considered. Three typologies of the several buildings were defined and used to consider the ASSETS of the site,

together with some important Public Spaces (see Table 2). Three possible answers to the question "What POLICIES can the Municipality of Ivrea adopt to communicate, enhance and exploit Olivetti's intangible legacy?" were identified and listed in Table 2.

The Compatibility and Schemes windows in Fig. 5 are some of the several tools of the Designing mode that were used to analyse the compatibility of decision options. The Schemes window indicates that 27 combinations of options, or schemes of action, are compatible, and highlights that 5 schemes are uncertain. The reason for this uncertainty is mainly related to the fact that Business and Social functions, if analysed alone, only partially are consistent with the identified policies.

The Business function is technically compatible with three typologies of assets, which only became two in the resulted compatible Schemes. This function is currently implemented on the site, in terms of a gym, offices and services, in the buildings with *huge, highly flexible spaces* (H_h_flex). Therefore, it can be assumed that this kind of asset is the most realistic option for business activities.

A Social function is not compatible with buildings with huge or open spaces, but it is with large spaces, even though they cannot be totally modified, due to Superintendence constraints, which are aimed at guaranteeing the preservation of their architectonic value. Therefore, a Social function (such as a retirement home) should be assigned to buildings with *large but not-flexible spaces* (L_not_flex) that do not require changes in their internal structure. The Social functions, if analysed alone, are not present in the Schemes, because incompatible with the Policies. But they are included when are combined with the Cultural and Leisure functions.

The Cultural and Leisure functions can easily be associated with buildings with *huge, highly flexible spaces* (H_h_flex), or *huge, flexible spaces* (H_flex) and with Public spaces. They can be associated with the other functions (see the Schemes window). Moreover, it is evident that all the identified policies are possible when cultural and leisure activities are implemented. In particular, it is evident the importance of *Mainly working on the communication of Olivetti's legacy values*, as a strategic policy to be activated alone or in synergy with other policies.

The Compatibility analysis was repeated with the DA "What intangible values have to be communicated, together with the tangible ones?" and these three options that express intangible values were considered: Cultural mediation between science, politics and beauty; Reactivation of the Community idea, i.e. a value that designed a human-based industrial site; and Innovation sustainability, i.e. the present value of Olivetti's innovative projects and ideas.

An interesting result was that all the options are compatible with all the assets, and contextually, only Cultural and Social functions, both individual and combined, are compatible with all the intangible values and the actions necessary to express them. It was hypothesised that it had not been a good choice to deal with the intangible values as possible decisions and their analysis was proposed in relation to another mode of SCA, that is, Comparing.

3.3. The expressions of judgements in the Comparison Areas

The Comparing mode of SCA was used to conduct an analysis of the three abovementioned courses of action that express intangible values. These courses of action were compared to establish their different "validities", in relation to their propensity to activate a site enhancement process that would be consistent with Olivetti's vision. The different potentialities and possible risks were analysed, in terms of these CAs: the Costs necessary to activate a course of action and the Time necessary to achieve some of the first expected results after its activation, the Visibility that a specific action could foster, the Capacity to attract private investors, Easy management after its implementation, and Acceptance of the citizens living in the Ivrea territory.

The procedure pointed out that a single action could generate negative consequences, at least for some of the involved actors, as well as possible conflicts. However, a combination of different courses of action

Table 2
The options in relation to assets, functions and intangible values.

DAs	Alternative options
ASSETS	Buildings with huge, highly flexible spaces (H_h_flex) Buildings with huge, flexible spaces (H_flex) Buildings with large but not-flexible spaces (L_not_flex) Green areas and open-air spaces (Public Spaces)
FUNCTIONS	Business: business incubator, co-working space, restaurant, health centre, etc. (B) Social: retirement home, social housing, student residence, etc. (S) Culture and Leisure: library, documentation centre, recreational centre, sport plants, etc. (CL)
MAIN POLICIES	Mainly working on the communication of Olivetti's legacy values (Communic) Reactivation of the whole site, which implies project integration in a systemic vision of the UNESCO site (Whole_react) Maximising the enjoyment of the site through events (Maxev), which can only be analysed together with another policy, in a combined implementation, to be consistent with the aim of communicating, enhancing and exploiting Olivetti's intangible legacy

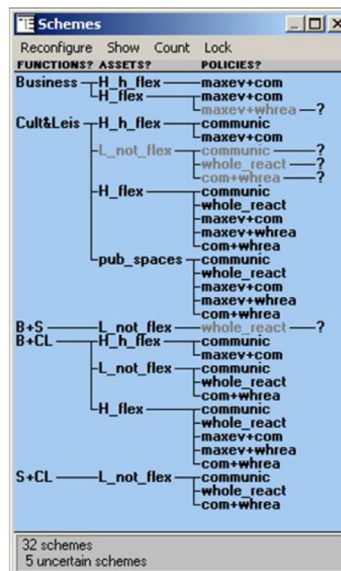
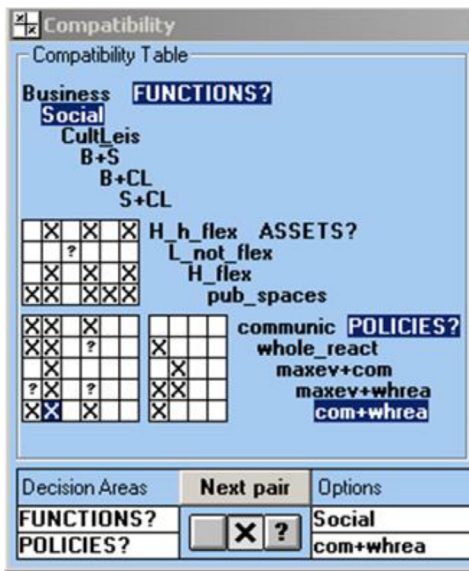

Fig. 5. Compatibility and Schemes windows.

and specific enhancement plans could improve the results. A combination of the three individual courses of action should be able to include projects of a different nature and satisfy the actors' expectations. Moreover, the projects should be coordinated with a systemic and overall vision of the situation of the site, and communication should be activated early on and with a great deal of care.

The Comparing mode of the SCA approach was also used to analyse and compare compatible schemes of action, that is, not to identify the best one but to try to express judgements and then identify values that can be formalised and translated into criteria.

3.4. Results from SCA as inputs for MCDA

Several sequences of the SCA operation modes generated a technical learning process by means of a continuous moving from the shaping of the decision problem to the designing of compatible actions and the identification and testing of CAs, to analyse the uncertainties associated with the compatible schemes of action and distinguish the different potentialities of the associated activities (enhancement actions or more detailed projects). Some CAs (judgements on the financial feasibility, easy and effective communication of the intangible values and possible risks) facilitated the research team in distinguishing the schemes of action and oriented it in transforming the CAs into analytic functions, that is, evaluation criteria.

Some steps of modelling and evaluation were developed, starting from some interesting results the SCA Compatibility and Schemes windows have produced (see Fig. 5): Cultural and Leisure activities can eas-

ily be associated with different kinds of building and also with green areas and open-air spaces, while Social and Business functions can only be associated with specific buildings. Any enhancement action pertaining to this UNESCO site should include cultural and leisure activities that will attract people within an acceptable period of time. Therefore, a project could propose a specific use of a single internal or external area or combine the reuse of some buildings and the use of the surrounding open-air spaces. A procedure was developed to deal with these kinds of locations and to identify their compatibility with specific cultural and leisure functions (see Section 3.4.1). The results were then used to develop two MC models, one to evaluate and compare six projects (see Section 3.4.2) and the other to evaluate all the compatible combinations of locations/cultural and leisure functions and to assign them to ordered risk categories (see Section 3.4.3).

3.4.1. Compatibility between specific locations and cultural and leisure functions

Four buildings with huge and flexible spaces can be identified as possible locations for cultural and leisure activities at the UNESCO site: 1 - the Central Heating Plant; 2 - the Social Services Centre; 3 - the Olivetti Company Canteen, which is directly linked to the hilly green area and to a recreation and rest area (e and d); 4 - the Data Processing Centre (Fig. 6). There are several public spaces in the proximity of these buildings, which are currently used as car parks (a, c and g in Fig. 6) or completely unused (b, f and h), and they could therefore be suitable for both cultural and recreational activities.

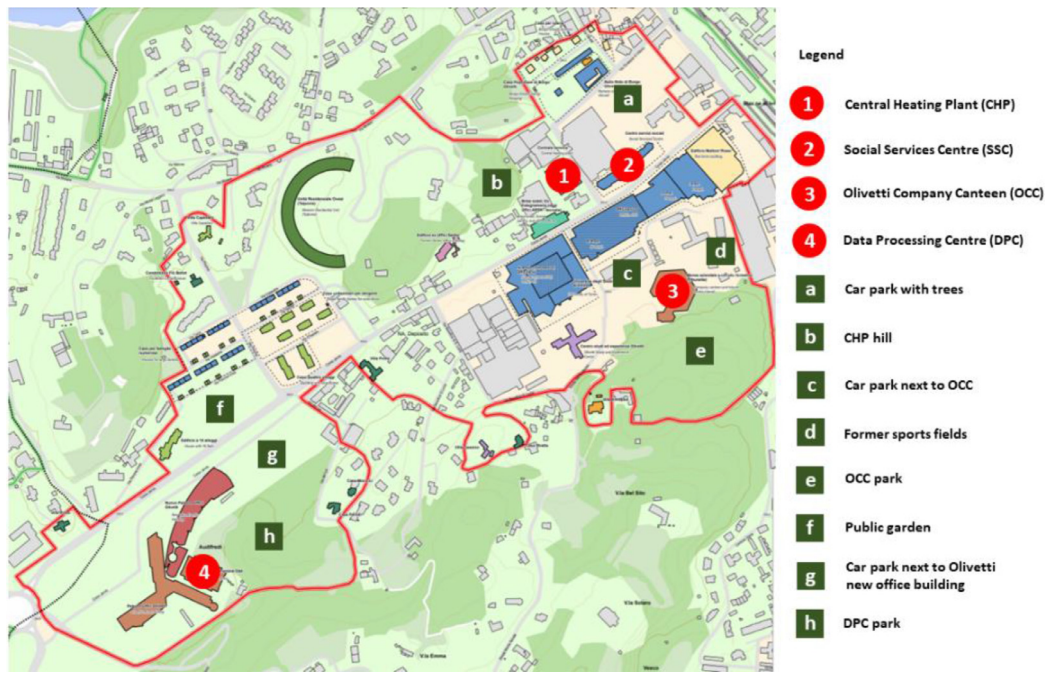

Fig. 6. Possible intervention areas in the “Ivrea, industrial city of the 20th century” UNESCO site.

Table 3
Combinations of the locations with specific cultural and leisure activities.

LOCATIONS	Single and combined open-air spaces					Indoor locations				Combination of the open-air spaces with the indoor locations			
	a	b	c+d+e	f+g+h	a+b+c+d+e+f+g+h	1	2	3	4	1+b	2+a	3+c+d+e	4+f+g+h
Music & Dance (M)	OK	NO	NO	OK	OK	OK	NO	NO	OK	OK	OK	NO	OK
Exhibitions (E)	OK	OK	OK	OK	OK	OK	OK	OK	OK	OK	OK	OK	OK
Sport/Recreation (S/R)	OK	NO	OK	OK	OK	OK	NO	NO	OK	OK	OK	OK	OK
M+E	OK	NO	NO	OK	OK	OK	NO	NO	OK	OK	OK	NO	OK
M+S/R	NO	NO	NO	OK	OK	?	NO	NO	?	?	OK	NO	OK
E+S/R	NO	NO	OK	OK	OK	?	NO	NO	?	?	OK	OK	OK
M+E+S/R	NO	NO	NO	OK	OK	?	NO	NO	?	?	OK	NO	OK

These possible locations were gathered into three groups in Table 3: single and combined open-air spaces, four indoor locations, and a combination of the open-air/indoor locations, where the indoor locations are the closest to the open-air locations. Other combinations could also be tested, for example, combinations of the buildings in the second group. However, this kind of combination, if associated with the first enhancement interventions of the site, seemed too complicated and expensive.

The locations in Table 3 were analysed in relation to their adequacy to host specific cultural and leisure activities. Some combinations were excluded (“no” in Table 3), because the activities resulted not consistent with the characteristics of the location. It is evident that some locations are “more flexible”, since they are compatible with all the activities, than others, which are compatible with only a few activities.

Fifty-three different activity/location combinations resulted possible. Some compatible combinations resulted consistent with proposals and analyses made in the last years. They are underlined in Table 3. Two MC models were created as examples of how the SCA preliminary results can be synthesised in evaluation models and then proposed to a collective analysis, in which each component of the SCA results and of the MC analysis should be discussed, validated or improved.

3.4.2. An MC model to evaluate and compare projects

Six of the fifty-three possible combinations were associated with identified projects, two in relation to recent proposals from two actors involved in the first phase of the process and three that were partially studied as part of a Master of Science course in “Architecture for Her-

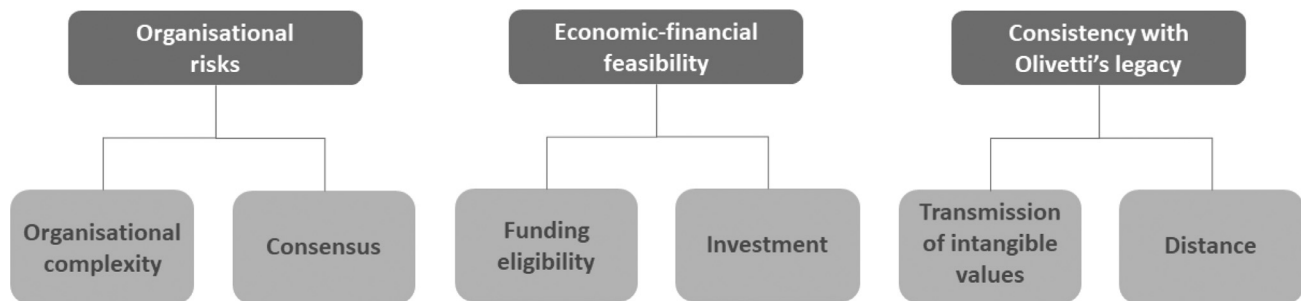

Fig. 7. Structure of the MC model for the ELECTRE II application.

itage preservation and enhancement” held at the Politecnico di Torino. A sixth potential project was also included in the set as a variant of a real proposal.

The first MC model was created to evaluate the six projects (highlighted in Table 3) on the criteria (whose ordinal evaluation scales can be easily and transparently described or co-created), compare and rank them, from the most urgent activity to the least urgent one for the enhancement of the whole site.

The main elements of an evaluation model, which the SCA Comparing mode suggested (see for example the CAs in 3.3, in relation to how intangible values can be expressed) were structured (see the logic tree in Fig. 7, with few strategic aspects, or model dimensions, and the two criteria pertaining to each related dimension).

An MC method, that is, the ELECTRE II method (Roy and Bertier, 1973), was adopted to compare the projects in relation to the criteria and their relative importance. The result indicated the different potentialities, and therefore priorities, of the projects in the process of the reactivation of the whole site. ELECTRE II, one of the oldest out-ranking methods, was used because its application is easy to explain and understand. The relationships between result and project evaluations can be easily analysed, any model partial change can be proposed and directly implemented, a new result and its logic understood.

This model and the ELECTRE II application and results seemed useful to introduce the MC language and potentialities with a very simple example that can easily be proposed to the Municipality of Ivrea and potential actors of the new decision phase, and discussed with them. The criteria and parameters of the MC model, method application and results were described in Norese et al. (2022).

3.4.3. An MC selection procedure

The second MC model was created to evaluate all the fifty-three possible actions that combine locations with specific cultural and leisure activities and are compatible in terms of operational requirements. An MC sorting method was applied as an example, to introduce other points of view, distinguish the possible actions in relation to the MC model and select adequate actions or reject unacceptable ones.

The structure of the model was defined in relation to a specific goal (the assignment of the fifty-three actions listed in Table 3 to risk categories) and to the conceptual more than operational nature of the actions. This structure included two main aspects, which were made operational by means of some criteria, that is, analytical functions that assign an evaluation to each action in relation to a specific scale. The two aspects and the associated criteria are proposed in Fig. 8.

The ELECTRE Tri method (Roy and Bouyssou 1993) was used to assign the fifty-three admissible actions to ordered risk categories (see Rolando et al 2022). The ELECTRE Tri variant (in this case, ELECTRE Tri-B), was only proposed as an example, like the definition of the decisional model parameters, in order to discuss and share these decisions in the participative context, together with the model structure, the nature of the criteria, and the evaluations proposed in the example.

4. Decision aiding to create a communication and organisational learning process

The COVID-19 emergency has generated time and logistic constraints concerning the communication of the preliminary results of this work. A communication virtual process was organised between the client, research team and Municipality of Ivrea in the Summer and Autumn of 2020, and the final online meeting was held in January 2021.

Some slides were created to illustrate the main complexity and uncertainty elements of the problem situation, the main components of the decision problem structure, from a technical point of view, and some examples of how the produced knowledge could be mixed with values to facilitate decisions. The file, which included the main elements of the applied methodology, was created so as to be analysed together with the client and then, in its synthetic version, with the Municipality of Ivrea. The file was created with a double aim, that is, of organising the communication and validation of the technical results and then, albeit only for some modular versions of the original file, of allowing a facilitated reading of the topics before their presentations and discussions in online meetings or workshops.

Therefore, the “readability” of the slides was tested. Some colleagues and master thesis students read the original file without having any knowledge of either the methodology or the decision problem. Its “readability” was thus verified, and it was only deemed necessary to improve a few elements.

The client then read the file, proposed the inclusion of some more details (for example, a slide with the MC evaluations of the actions, in order to better explain a technically important step) and asked for clarification of the possible use of the file. The research team and the client analysed and discussed the file during two online meetings. They found that the problem formulation was clear and the description of all the main components understandable, but too long and detailed. The MC model was also considered clear, and the results of an MC method application were found to be very interesting, as they offered the possibility of questioning and immediately obtaining answers that could partially change the model and repeat some steps of the analysis.

The team and the client then defined a proposal for the Municipality: an online meeting with the Mayor and some council members the Mayor would indicate, in order to declare the aims of the study and propose a few structuring elements and MC models as examples of how some realistic enhancement projects of the UNESCO site could be evaluated, compared and ranked, or a set of enhancement actions could be assigned to ordered categories of market/administrative risk.

A synthetic and legible version of the file was sent to the Mayor and to the UNESCO site coordinator (after a phone call to anticipate the proposal of an online meeting), to introduce the concepts and keywords of the integrated methodology, and to anticipate the topics of the presentation. The problem description was proposed to the new administration as the starting point to foster relationships and facilitate the Municipality in the activation of the site enhancement process. The

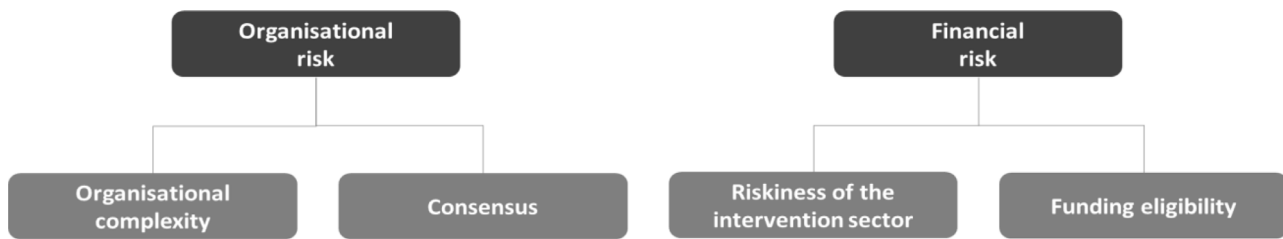

Fig. 8. Structure of the MC model for the ELECTRE Tri application.

main message that anticipated the presentation was that “it is important to clearly define the decision problem and its structure, as well as to organise and activate a decision system and a new phase of the decision process. Moreover, a technical and neutral vision of the problem situation could be useful to create an agenda for other online meetings with a larger participation of the potential actors in the decision process”.

4.1. Presentation and reactions of the Municipality

Before the presentation, the main aims of the study were declared as: facilitating an incremental development of knowledge in relation to the activities of strategic planning; clarifying the goals and constraints and adopting a multidimensional vision of the decision problem; analysing the economic and financial feasibility of the possible activities, and the eco compatibility of the whole system; fostering urban regeneration, new technologies and convergence of public/private interests.

The methodology and its preliminary results were illustrated and the following sentences were used to conclude the presentation:

“The results have highlighted the great importance of the cultural and leisure activities, which can be located in different typologies of buildings and public spaces. MC models and methods were used to verify whether and how these activities can satisfy the present and future expectations and foster enhancement of the site within an acceptable period of time. It is also worth mentioning the importance of public spaces, where the Municipality of Ivrea is able to easily intervene without the constraints imposed by the private owners of the buildings. Moreover, the redevelopment of public spaces represents a strategic choice, both to improve the quality of the areas surrounding the private buildings and the accessibility and the enjoyment of the UNESCO site for tourists and citizens.

Assuming these perspectives, the research team could organize two workshops in order to present the methodology and discuss its preliminary results. The first workshop could be organized with the Coordinator of the UNESCO site or a representative of the Municipality, some potential actors from the territory and the owners of the private assets, in order to involve these parties in exploring and verifying certain elements of the problem, in acquiring knowledge of the local processes, in discussing and updating the technical choices of the applied methodology, and in identifying the main values of the participants. The second workshop could be organized with the Mayor and the council members, plus other public organisations included by the Municipality, in order to introduce some enhancement policies, to test the reaction of the parties, in relation to the technical proposal of policies and to verify whether some unexpressed values and policies exist and have been perceived, discussed or implemented”.

The first reaction of the Municipality, after the presentation, was a description of the latest private initiatives (such as some news about the future location and visibility of the Historical Olivetti Archive) and activities of the Municipality, which could in turn be used to update the models. Moreover, the Coordinator of the UNESCO site briefly illustrated the progress of two ongoing procedures - the Heritage Im-

pact Assessment (HIA) and the Strategic Conservation Plan (SCP) - and promised to share informative documents.

The logic of the methodology resulted clear and the results convincing. The Municipality appreciated the description of the problem as well as the evaluation tools and their possible applications. The Coordinator of the UNESCO site proposed using MC models and methods to ex post validate decisions, to facilitate the monitoring requested by UNESCO³ and to contribute to the HIA procedure.

The HIA and the SCP documents arrived after some weeks and were discussed by the research team together with the client. These documents only included some ideas about the definition of bureaucratic procedures but did not refer to the request of assessing any impact on the Outstanding Universal Value of the site (World Heritage Committee, 2018) or of any connection with the actors of the previous process and/or with the team involved in the HIA and SCP procedures.

A subsequent series of contacts with the Municipality clarified the situation. However, the proposal of using the presented preliminary outcomes in two workshops, to facilitate the activation of an enhancement process, was not taken into consideration. Any contact between the analysts and organisations of the territory was discouraged, because the participative and inclusive nature of the proposed procedure, after its application at a technical level, was not accepted by the site Coordinator. It was also underlined that the role of the Public Administration in the enhancement of the UNESCO site had been and would remain minimal or even absent, in relation to the public spaces, while private organisations were and would be active in proposing and activating projects.

It was evident to the client that the Politecnico di Torino could not be involved without playing an official role, above all in relation to the possible actors of the enhancement process. Contact between the Politecnico di Torino and the Administration was interrupted in March 2021, one year before the next administrative election, when the Municipality will have to answer the question “How was the enhancement of the UNESCO site planned and implemented?”

The client, frustrated by the circumstances, renounced any activity that could facilitate the reactivation of the decision process, at least until after the administrative election in 2023.

Conclusions

The situation that the Municipality of Ivrea currently has to manage is very complicated. The activation and management of an UNESCO site is a difficult challenge for the Public Administration, which is called upon to enhance large and outstanding assets in a scenario of very limited or even lacking public resources. Several risks and uncertainties make any decision difficult or impossible.

After the inclusion of the “Ivrea, industrial city of the 20th century” site in the UNESCO WHL in 2018, the site enhancement process seemed to stop and the reactivation of the process became very difficult.

However, a new decision process could be activated, with new actors, although the Municipality should maintain its central role. It is

³ The World Heritage Committee (2018) requested the setting up of a monitoring system to monitor the state of conservation of the attributes, and the mitigation of identified pressures.

essential that the decision problem and its structure should be clearly defined, and a decision system should be organised and activated. The integrated use of logical and analytical decision aiding approaches could help in these complex tasks, as they could involve the potential actors in a communication and organisational learning process, thereby guiding an incremental development of knowledge, facilitating problem understanding and fostering relationships and actions.

The client of this study, who had promoted the creation of the interdisciplinary research team and oriented the analysis, considered the systematic and overall vision of the problem situation and the integrated decision aid methodology to be suitable for aiding the key actor, the Municipality of Ivrea, in activating or reactivating the decision process and establishing a formal decision system.

The communicative potentialities of the integrated methodology were clearly understood when the results of a possible application were presented to the Major and the Coordinator of the UNESCO site, who proposed the use of MC models and methods to *ex post* validate decisions. Unfortunately, they did not take into consideration the proposal of interacting with some potential actors, by means of the organization of two workshops, whereby the enhancement of the whole site could have been analysed from a public perspective.

The attempt to trigger an enhancement process failed because the proposed approach did not move from the technical level to the participative one. The authors' recommendation of using the outcomes of the technical phase in the participative and inclusive phase of the proposed procedure was not accepted, because the Coordinator of the site did not consider the required involvement of the potential actors in informal workshops practical or useful, and could even have been risky.

Thus, the client renounced fostering the activation of a new decision process, at least until after the administrative election in 2023.

The lessons learned and the results achieved from this study have underlined that a possible negative reaction to the passage from a technical to a participative phase should be prevented at the start of a future intervention by clearly indicating that the development of shared knowledge facilitates the activation of a decision system, but also implies setting up relationships and participation.

The methodology was appreciated by the client (and the research team) as a proposal of extending the notion of "decision aiding" to a context whereby any decision process is *in fieri* and a decision system has not yet been activated. The aim of the methodology is to materialise ideas, proposals and visions in an integrated description of the problem knowledge and to monitor any progress of this knowledge that an involvement of potential actors and their new relationships generate. Problem Structuring Methods are not used to facilitate decision makers in structuring the decision problem, they are instead used to integrate and visualise knowledge that exists but is fragmented, while MCDA is not used to aid decision makers, but rather to describe how this integrated knowledge can be used operationally to send the message across that several activities can be evaluated, selected or excluded, and to stimulate potential actors to collaborate in a new process.

Other tools were used together with SCA in this first application (see [Rolando et al., 2022](#)), and will be used in future applications. Different tools can be used in this integrated methodology, but only if they are used with the same logic, i.e. not to facilitate decision makers in structuring or choosing, but to visualise knowledge and its growth or adjustment, and facilitate communication between stakeholders as an opportunity to activate a decision process.

The main value of the methodological approach that was appreciated by the client was the feasibility of an integration of fragmented knowledge that produced good outcomes, in terms of easy and logical visualisation and possible operational use. In fact, the client considered the adopted methodological approach very interesting and proposed it for other roles, involving the Politecnico, throughout the territory.

The integrated methodology is currently being applied in relation to a new case, that is, the reuse of a large area built in 1935 in the centre of Turin and until recently used as a hospital. The decision system

has not yet been fully defined; the area is owned by two distinct organisations and the Municipality of Turin will be an important actor in a process that has not yet officially been activated. The research team is currently preparing a synthesis of knowledge for the client, where some preliminary quantitative analyses on the market risks are directly connected with specific aspects of each technically feasible reuse project. However, the not so synergic relationship with the Municipality of Ivrea suggests an analysis better focalised on the organisational and administrative risk, which in the previous study proved to be higher than the client's prevision. The first workshop will be limited to two or three key actors.

The creation of a communication process is not easy to achieve in Italy, as any committee is commonly seen as a fighting arena where conflictual behaviour often reduces or eliminates any possibility of obtaining results. The COVID-19 emergency has made this situation even worse, but at the same time could facilitate a change in the Italian way of thinking.

The negative reaction to the passage to a participative level has underlined that the integrated methodology can be proposed to stakeholders who are willing to participate in workshops that should only be considered as preparatory events, and not as formal committees. Such workshop participants are not the members of a committee, although conflictual visions may be expressed, either directly or indirectly. In such a case, any possible contradictions or conflictual points of view should be recognised and discussed immediately. Logical and analytical tools can be used as procedural references that reduce misunderstandings and ambiguities. Specific rules should be defined to control conflictual behaviour and to avoid the "fighting arena" factor. A detailed analysis of the behavioural attitude of the participants, their reactions and points of view is essential after any meeting or workshop.

The software tools used to apply decision aid methods allow the participants to visualise problems and model structures and to understand procedures and results. However, their use in a round-table meeting is only acceptable if the number of participants is very limited. When meetings and workshops are held online, a communication virtual process implies an approach in which different media (e-mails, phone calls, platforms, recordings, simple files, reports after each meeting, etc.) have to be used in parallel, and a modularity of the message has to be created, with a consequent multiplication of the communication actions in different online meetings and workshops. An integration of hard and soft technologies facilitates participation in such situations. The software tools used to apply decision aid methods become digital interaction platforms for the online workshops, and these virtual spaces are used to express points of view, criticisms and preferences, as well as to propose operational scenarios. Any revision or new input for problem formulation and structuring, any new scenario or evaluation proposal is automatically documented, and an analysis of the shared path facilitates the passage from a conflictual to a cooperative situation.

Declaration of Competing Interest

The authors declare that they have no known competing financial interests or personal relationships that could have appeared to influence the work reported in this paper.

References

- Bana e Costa, CA, Ensslin, L, Correa, EC, Vansnick, J-C, 1999. Decision support systems in action: integrated application in a multicriteria decision aid process. *Eur. J. Oper. Res.* 113, 315–335.
- Barreca, A, Curto, R, Rolando, D, 2017. An innovative methodological and operational approach to developing Management Plans for UNESCO World Heritage Sites: a Geographic Information System for "Ivrea, industrial city of the 20th century". *Aestimum* 71, 177–213.
- Barreca, A, Curto, R, Rolando, D, 2020. A dynamic GIS for the sustainable economic development of the Ivrea UNESCO site: potentialities and constraints of a knowledge exchange process. In: *Proceeding of IFKAD 2020 - Knowledge in Digital Age, Matera, Italy 9-11 September 2020*, pp. 1217–1238.

- Belton, V, Ackermann, F, Shepherd, I, 1997. Integrated Support from Problem Structuring through to Alternative Evaluation Using COPE and VISA. *J Multi-Crit Decis Anal* 6, 115–130.
- Belton, V, Stewart, TJ, 2010. Problem structuring and multiple criteria decision analysis. In: Ehr Gott, M, Figueira, JR, Greco, S (Eds.), *Trends in Multiple Criteria Decision Analysis*, International Series in Operations Research and Management Science 142. Springer-Verlag, Heidelberg, pp. 209–239.
- Bouyssou, D, 1990. Building criteria: a prerequisite for MCDA. In: Bana e Costa, CA (Ed.), *Readings in Multiple Criteria Decision Aid*. Springer, Berlin, pp. 58–80.
- Curto, R, Barreca, A, Rolando, D, 2018. Restoration, Reuse and Energy retrofit for the enhancement of 20th Century Heritage: a learning experience on the Ivrea Site Inscribed on the UNESCO World Heritage List. *Valori e Valutazioni* 21, 41–58.
- Curto, R., Barreca, A., Coscia, C., Ferrando, D.G., Fregonara, E., Rolando, D., 2021. The active role of students, teachers, and stakeholders in managing economic and cultural value, urban and built heritage. *Interdiscip. J. Problem-Based Learn.* 15 (1).
- Ehr Gott, M, Figueira, JR, Greco, S, 2010. *Trends in Multiple Criteria Decision Analysis*. Springer, New York.
- Ferreira, F, Santos, S, Rodrigues, P, 2011. Adding value to bank branch performance evaluation using cognitive maps and MCDA: a case study. *J. Oper. Res. Soc.* 62, 1320–1333.
- Figueira, J, Mousseau, V, Roy, B, 2005. ELECTRE methods. In: Figueira, JR, Greco, S, Ehr Gott, M (Eds.), *Multiple Criteria Decision Analysis: State of the Art Surveys*. Springer-Verlag, New York, pp. 133–153.
- Friend, JK, 1989. The strategic choice approach. In: Rosenhead, J (Ed.), *Rational Analysis for a Problematic World: Problem Structuring Methods for Complexity, Uncertainty and Conflict*. Wiley, Chichester, pp. 121–158.
- Friend, JK, 2002. STRAD – The Strategic Adviser – User Manual. Stradspan Limited, Sheffield.
- Friend, JK, Jessops, WN, 1969. *Local Government and Strategic Choice Approach*. Pergamon Press, Oxford.
- Georgiou, I, Heck, J, Mrvar, A, 2019. The analysis of interconnected decision areas: a computational approach to finding all feasible solutions. *Group Decis. Negot.* 28, 543–563.
- Greco, S, Ehr Gott, M, Figueira, JR, 2016. *Multiple Criteria Decision Analysis. State of the Art Surveys*. Springer-Verlag, New York.
- Han, H, Laiô, S-K, 2011. Decision network: a planning tool for making multiple, linked decisions. *Environ. Plann. B* 38, 115–128. doi:10.1068/b35153.
- Marttunen, M, Lienert, J, 2017. Structuring problems for Multi-Criteria Decision analysis in practice: a literature review of method combinations. *Eur. J. Oper. Res.* 263, 1–17.
- Mingers, J, Rosenhead, J, 2004. Problem structuring methods in action. *Eur. J. Oper. Res.* 152, 530–554. doi:10.1016/S0377-2217(03)00056-0.
- Montibeller, G, Belton, V, Ackermann, F, Ensslin, L, 2008. Reasoning maps for decision aid: an integrated approach for problem-structuring and multi-criteria evaluation. *J. Oper. Res. Soc.* 59, 575–589.
- Municipality of Ivrea (Department of Culture) and Adriano Olivetti Foundation, 2012. Management Plan "Ivrea, città industriale del XX secolo" - Tentative List WHL - UNESCO. Comune di Ivrea, Ivrea.
- Norese, MF, 1996. A process perspective and multicriteria approach in decision-aiding contexts. *J. Multi-Crit. Decis. Anal.* 5, 133–144.
- Norese, MF, 2016a. Decision aid in public administration: from evidence-based decision making to organizational learning. In: Zopounidis, C, Doumpos, M (Eds.), *Multiple Criteria Decision Making: Applications in Management and Engineering*. Springer, Heidelberg, pp. 1–29. doi:10.1007/978-3-319-39292-9_1.
- Norese, MF, 2016b. A model-based process to improve robustness in Multi Criteria Decision Aiding interventions. *J. Multi-Crit. Decis. Anal.* 23, 183–196.
- Norese, MF, 2020a. Profiling analysts and actors in interaction: how behavioural aspects can positively affect the decision aid process. *EURO J. Decis. Process.* 8, 125–150.
- Norese, MF, 2020b. SISTI: a multicriteria approach to structure complex decision problems. In: Ben Amor, S, Teixeira de Almeida, A, de Miranda, JL, Aktas, E (Eds.), *Advanced Studies in Multi-Criteria Decision Making*. Taylor & Francis, New York, pp. 57–80.
- Norese, MF, Galliano, R, Rolando, D, 2015. A methodology to support a concerted approach when the context is non-collaborative. *Int. J. Decis. Support Syst.* 1, 412–437.
- Norese, MF, Montagna, F, Riva, S, 2008. A multicriteria approach to support the design of complex systems. *Found. Comput. Decis. Sci.* 33, 53–70.
- Norese, MF, Montagna, F, Vinardi, FM, 2004. Multicriteria modelling and rational use of waste. In: Meredith, R, Shanks, G, Arnott, D, Carlsson, S (Eds.), *Decision Support in an Uncertain and Complex World*. Monash University, Prato, pp. 598–607.
- Norese, MF, Rolando, D, Curto, R, 2022. DIKEDOC: a multicriteria methodology to organise and communicate knowledge. *Ann. Oper. Res.* 1–34.
- Olivetti, A, 1945. *L'ordine politico di comunità*, Nuove Edizioni, Ivrea, new ed. Edizioni di Comunità Olivettiana, Ivrea 2014.
- Paucar-Caceres, A, Ribeiro dos Santos, P, Wright, G, Belderrain, MCN, 2019. Soft situational strategic planning (SSSP): a method and case study of its application in a Brazilian municipality. *J. Oper. Res. Soc.* 71, 363–380. doi:10.1080/01605682.2019.1568840.
- Rolando, D, 2015. Multicriteria decision problem structuring: The Strategic Choice Approach in the context of public projects in Italy. *Int. J. Multicrit. Decis. Making* 5, 4–38. doi:10.1504/IJMCDM.2015.067942.
- Rolando, D, Norese, MF, Curto, R, 2022. An integrated use of decision aid tools to organise and communicate knowledge in a complex socio-economic context. *Proceeding of IFKAD 2022 - Knowledge drivers for resilience and transformation*, Lugano, Switzerland 20-22 June 2022.
- Rosenhead, J, 1989. *Rational Analysis for a Problematic World: Problem Structuring Methods for Complexity, Uncertainty and Conflict*. Wiley, Chichester.
- Rosenhead, J, Mingers, J (Eds.), 2001. *Rational Analysis for a Problematic World Revisited*. Wiley, Chichester.
- Roy, B, 1978. Electre III: Un algorithme de classements fondé sur une représentation floue en présence de critères multiples. *Cahier du CERO* 20, 24–27.
- Roy, B, 1990a. Decision-aid and decision-making. *Eur. J. Oper. Res.* 45, 324–331.
- Roy, B, 1990b. The outranking approach and the foundations of ELECTRE methods. In: Bana e Costa, CA (Ed.), *Readings in Multiple Criteria Decision Aid*. Springer-Verlag, Heidelberg, pp. 155–184.
- Roy, B, 1996. *Multicriteria methodology for Decision Aiding*. Kluwer, Dordrecht.
- Roy, B, Bertier, P, 1973. *La méthode ELECTRE II - une application au media-planning*. In: Ross, M (Ed.), *OR'72*, pp. 291–302 North-Holland, Amsterdam.
- Roy, B, Bouyssou, D, 1993. Aide multicritère à la décision: méthodes et cas. *Economica, Collection Gestion*, Paris.
- Roy, B, Slowinski, R, 2013. Questions guiding the choice of a multicriteria decision aiding method. *EURO J. Decis. Process.* 1, 69–97.
- Stewart, TJ, Joubert, A, Janssen, R, 2010. MCDA framework for fishing rights allocation in South Africa. *Group Decis. Negot.* 19, 247–265.
- UNESCO World Heritage Committee, 2018. Convention concerning the protection of the world cultural and natural heritage, United Nations Educational, scientific and cultural organization. World Heritage Committee, Forty-Second Session Manama, Bahrain 24 June –4 July 2018 (Accessed online).
- White, L, 2009. Understanding problem structuring methods interventions. *Eur. J. Oper. Res.* 199, 823–833. doi:10.1016/j.ejor.2009.01.066.
- Yu, W, 1992. ELECTRE TRI: Aspects méthodologiques et manuel d'utilisation. Document du LAMSADE LAMSADE Université Paris-Dauphine 74.