

Hypersonic aircraft and mission concept re-design to move from Mach 8 to Mach 5 operations

*Original*

Hypersonic aircraft and mission concept re-design to move from Mach 8 to Mach 5 operations / Viola, Nicole; Fusaro, Roberta; Ferretto, Davide; Gori, Oscar; Marini, Marco; Roncioni, Pietro; Cakir, Bora Orcun; Ispir, Ali Can; Saracoglu, Bayindir Husein. - ELETTRONICO. - 2:(2022), pp. 1218-1234. ( 33rd Congress of the International Council of the Aeronautical Sciences Stockholm, SE 4-9/09/2022).

*Availability:*

This version is available at: 11583/2978796 since: 2023-05-30T09:37:10Z

*Publisher:*

ICAS

*Published*

DOI:

*Terms of use:*

This article is made available under terms and conditions as specified in the corresponding bibliographic description in the repository

*Publisher copyright*

(Article begins on next page)

# HYPERSONIC AIRCRAFT AND MISSION CONCEPT RE-DESIGN TO MOVE FROM MACH 8 TO MACH 5 OPERATIONS

N. Viola<sup>1</sup>, R. Fusaro<sup>1</sup>, D. Ferretto<sup>1</sup>, O. Gori<sup>1</sup>

M. Marini<sup>2</sup>, P. Roncioni<sup>2</sup>

B. O. Cakir<sup>3</sup>, A. C. Ispir<sup>3</sup>, B. H. Saracoglu<sup>3</sup>

<sup>1</sup>Mechanical and Aerospace Engineering Department, Politecnico di Torino, Italy

<sup>2</sup>Italian Aerospace Research Centre (CIRA)

<sup>3</sup>Von Karman Institute for Fluid Dynamics (VKI)

## Abstract

This paper discloses the design of a new Mach 5 civil passenger aircraft developed in the H2020 MORE&LESS Project, by exploiting the results of the previous H2020 STRATOFly Project. To assure that the highest aerodynamic, propulsive, and operating performance are reached when approaching Mach 5 conditions, instead of the original Mach 8, a multidisciplinary methodology is developed and applied to integrate aerodynamics and propulsion aspects within a proper workflow able to generate a consistent vehicle concept meeting high-level requirements.

**Keywords:** Multidisciplinary Aircraft Design, Waverider aircraft, Mission Analysis, High-speed Aerodynamics, High-speed Propulsion

## 1. Introduction and Background

Since almost two decades, Europe is facing a renovated interest and positive momentum for high-speed civil passengers transport and now European Universities, Research Centres and Industries are leading international consortia aimed at re-thinking the near and far future of high-speed civil transport in terms of environmental sustainability and social acceptance. In this context, the European Commission is funding the H2020 MORE&LESS Project (MDO and REgulations for Low boom and Environmentally Sustainable Supersonic aviation) [1], aiming at supporting Europe to shape global environmental regulations for future supersonic aviation: recommendations will be established on the basis of the outcomes of extensive high-fidelity modelling activities and test campaigns that merge into the multi-disciplinary optimization framework to assess the holistic impact of supersonic aviation onto environment. The MORE&LESS project kicked-off at the beginning of 2021 and will run for four years. One of the crucial objectives targeted in the first months of the project is the definition of the new high-speed aviation paradigm [2], in order to provide the project with a set of meaningful real case-studies to be further analysed. At first, different disciplines will tackle separate design topics through modelling and tests and then the environmental impact of these aircraft concepts will be evaluated through the holistic framework. To further extend the validity of theories and models, the entire spectrum of supersonic speed regime ranging from Mach 2 to Mach 5 is considered. Moreover, the analysis is not only restricted to aircraft using traditional hydrocarbon fuels, but it moves beyond, addressing aircraft concepts exploiting alternative fuels, such as biofuels and cryogenic fuels. The idea of considering more case-studies with different configurations, performance and fuels, fosters the enhancement of the flexibility of the tools, which, starting from the case-studies themselves, are developed based on modelling activities and test campaigns as products that can be flexible enough to be applied to several vehicle concepts.

Among the various high-speed aircraft and mission concepts currently under investigation in the H2020 MORE&LESS project, this paper focuses on the so-called MR5 concept. Named after its predecessors, MR2.4 and MR3 configurations, the MR5 is meant to be a civil passenger aircraft

cruising at Mach 5 and developed by exploiting the results coming from the previous H2020 STRATOFly Project [3-5]. Specifically, to assure that the highest aerodynamic, propulsive, and operating efficiencies are reached when approaching Mach 5 conditions, instead of the original Mach 8 set for the MR3 vehicle and its mission concept [6], a multidisciplinary methodology has been developed and applied. The paper provides guidelines to conceptually re-design the Mach 8 waverider concept to improve its efficiency and environmental sustainability when operating in subsonic and supersonic flight regimes, with Mach numbers from Mach 0.3 to Mach 5. The derived Mach 5 concept exploits liquid hydrogen to feed a set of Air Turbo Rockets (ATR) up to Mach 4 and a Dual Mode Ramjet (DMR) propulsive technology in cruise condition. In details, Section 2 provides an overview of the multidisciplinary design methodology to meet the challenging goal of re-designing a high-speed aircraft. In addition, it provides a focus on the investigations and re-design suggestions coming from the aerothermodynamic and propulsive experts. Then, Section 3 provides proper attention to the design synthesis phase, where the requirements coming from the different disciplines are collected, the trade-off process is performed and the selection of the alternative designs is made. However, to verify the compliance of the new design solutions with the high-level requirements, it is utmost important to develop a new 3D CAD model and to check whether the re-designed concept still fits the flow field used for the generation of the waverider layout of the aircraft. The availability of a representative CAD model is fundamental to generate simplified aerodynamic and propulsive databases, which can be used to run sets of preliminary mission analyses, as pointed out in Section 4, where main conclusions are also drawn.

## **2. Vehicle and Mission re-design Methodology**

### **2.1 Methodology Overview**

The methodology developed to move from a Mach 8 to a Mach 5 aircraft, with the aim of exploiting as much as possible the European heritage in the field, is graphically summarized in Figure 1. As clearly stated in the introduction, the need to focus on the supersonic regime, according to the project aims, urges to reconsider the original vehicle layout (Section 2.2) while keeping a similar configuration in terms of aerodynamics and propulsive flow path so not to jeopardize a concept which has proven to be efficient in terms of both performance and operations at Mach 8. In order to do so, a first assessment on the capabilities of the aircraft in high supersonic regime (Mach 5) is expected, without modifications to the original size of the vehicle. Indeed, the original MR3 aircraft was already conceived to fly through the Mach 5 conditions, along the reference trajectory (Section 2.2), even if a proper cruise was not originally envisaged at these specific dynamic pressures, being considered now as a proper off-design condition. Analyses on aerodynamic and propulsive performance, as well as on the overall mission can then be performed on a modified profile in order to understand the opportunity to stick with the very same configuration or not. The decision shall be made according to the verification of the consistency of performance indexes with the requirements put in place for the updated mission, with an eye on the overall aero-propulsive efficiency, crucial aspect for such kind of aircraft. In fact, it is important to highlight that the approach described hereafter is mainly needed to produce an efficient vehicle. The original layout may still be capable of flying such an alternative mission with the current configuration, however incurring in loss of global efficiency, which are not acceptable within a sustainable supersonic aviation paradigm. In case modifications are needed, it is theoretically possible to start investigating the areas of the aircraft to be updated in order to meet the newly established requirements, specifically looking at aerodynamics and propulsion plant characterization. Specific suggestions for the re-design, starting from the original configuration, are in fact expected, with particular focus on air intake and nozzle areas. Starting from these data it is thus possible to modify the layout, synthesizing the aerodynamic and propulsive needs within a flyable solution for the Mach 5 cruise environment, extensively exploiting the possibilities offered by the CAD environment. Waverider parametrization is, in fact, particularly critical in terms of identification of the suitable lifting surface within a specific flow field, and modifications to the layout need to be assessed within a well-defined characterization process involving the description of the shock-induced flow as well as of the definition of geometrical constraints of the aircraft (to meet the original sketch in the unmodified areas). Once an overall layout is produced, embedding preliminary suggestions from aerodynamic and propulsion analyses, a two-levels concept validation process can be performed, starting from low-fidelity models for aerodynamic and propulsive performance estimation (exploiting theoretical models available in literature), up to high-fidelity simulations based on CFD. In parallel, also depending on the level of fidelity applied, different mission analyses can be performed to verify the consistency of the concept with mission requirements, in terms of payload-range capability, fuel

## HYPERSONIC AIRCRAFT AND MISSION CONCEPT RE-DESIGN TO MOVE FROM MACH 8 TO MACH 5

consumption and on-cruise/off-cruise conditions. The overall process is based on iteration loops in order to reach the final vehicle assembly, since aerodynamic, propulsive and mission-related performance are strictly influencing each other and also impacting vehicle thrust matching and balance [7]. The main outcome will be, in the end, a highly integrated Mach 5 configuration, meeting the updated mission requirements and some of the original constraints from the reference vehicle.

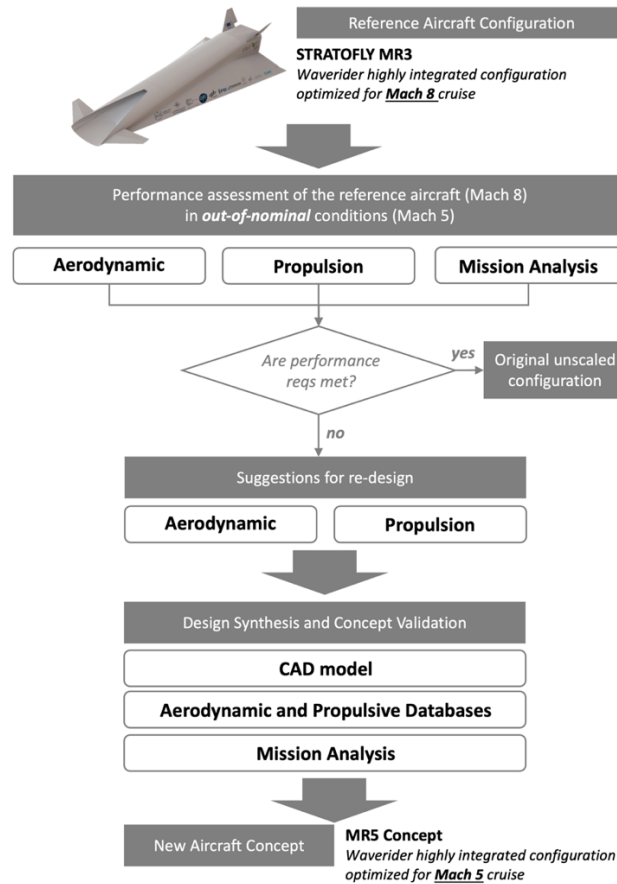

Figure 1 – Overview of the re-design methodology

### 2.2 Brief overview of the reference vehicle: STRATOFly MR3

From the configuration standpoint, the STRATOFly MR3 aircraft (Figure 2) is characterized by a waverider architecture, with a dorsal-mounted propulsion plant duct, a canard and a V-Tail layout for directional stability and control. The integration of the propulsive system at the top of the vehicle allows maximizing the available planform area for lift generation without additional drag penalties, thus increasing the aerodynamic efficiency, and it allows optimizing the internal volume. This layout guarantees furthermore to expand the jet to a large exit nozzle area without the need to perturb the external shape which would lead to extra pressure drag. Specifically, STRATOFly MR3 integrates 6 Air Turbo Rocket engines, ATR, that operate up to Mach 4 - 4.5 and one Dual Mode Ramjet, DMR, that is used for hypersonic flight from Mach 4.5 up to Mach 8.



Figure 2 - The STRATOFly MR3 hypersonic cruiser

The external dimensions are characterized by an overall length of 94 m (excluding protruding rudders) and by a wingspan of 41 m. The planform area (excluding canards) is thus around  $2491 \text{ m}^2$  with an overall internal volume arrangement of roughly  $10000 \text{ m}^3$ .

The STRATOFly MR3 vehicle was supposed to cover antipodal routes, performing the cruise at stratospheric altitude (30-35 km) at Mach 8. The vehicle is designed to host 300 passengers as payload. The propellant mass used as reference is 181.25 Mg and the take-off weight for the mission is equal to 400 Mg. The STRATOFly MR3 vehicle has been originally conceived to cover antipodal routes with a distance flown up to around 19000 km. The reference trajectory considered in this analysis is the Brussels to Sydney mission.

During the first part of the mission the ATR engines are used up to Mach 4 – 4.5. At the end of this phase, the ATR engines are turned off and the DMR is activated to accelerate up to Mach 8 at an altitude of 32-33 km (hypersonic climb). Here, the cruise starts ranging between an altitude of about 33 and 35 km. An overview of the complete trajectory is reported in Figure 3, where the main characteristics of the trajectory can be clearly identified.

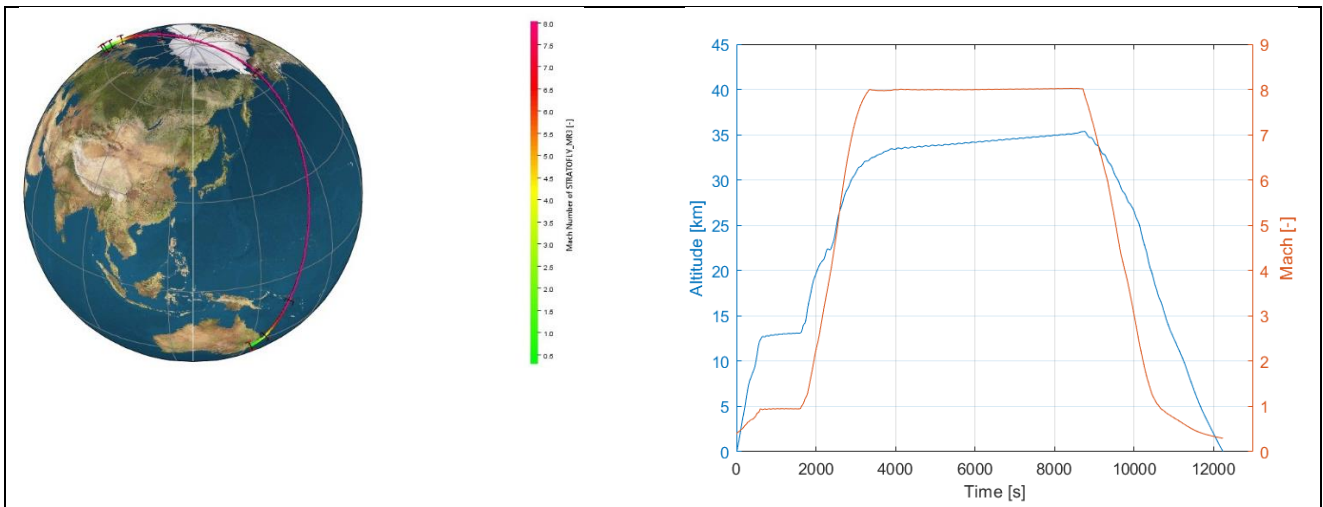

Figure 3 - Overview of complete MR3 trajectory BRU-SYD. Trajectory (left) is painted as function of Mach number

### 2.3 Performance assessment of the MR3 at Mach 5

As discussed in Section 2.1, the first attempt for verifying the need of modifications to the original MR3 layout consist on theoretically testing the vehicle on a different mission profile characterized by a Mach 5 cruise. Cruise altitude is set at 25 km for consistency with the original operational concept (in terms of altitude – Mach number coupling). Considering the aerodynamic performance of the aircraft [6,8] an excess of lift can be noticed during the entire Mach 5 regime, from Beginning of Cruise (BoC) to End of Cruise (EoC), as shown in Figure 4. As result, it is also difficult to maintain the cruise altitude of 25 km, also in case of slightly negative attitudes ( $-1^\circ$  AoA), which are introduced to partially reduce the effect. Moreover, according to propulsive performance [9], the fuel consumption is also quite lower with reference to the original one and, even if starting the flight with a reduced value of LH2 (around 140 Mg instead of 181.25 Mg of the original configuration), 20 Mg of propellant are left in the tanks at the destination (Figure 5) because of the more favorable operating point of the powerplant.

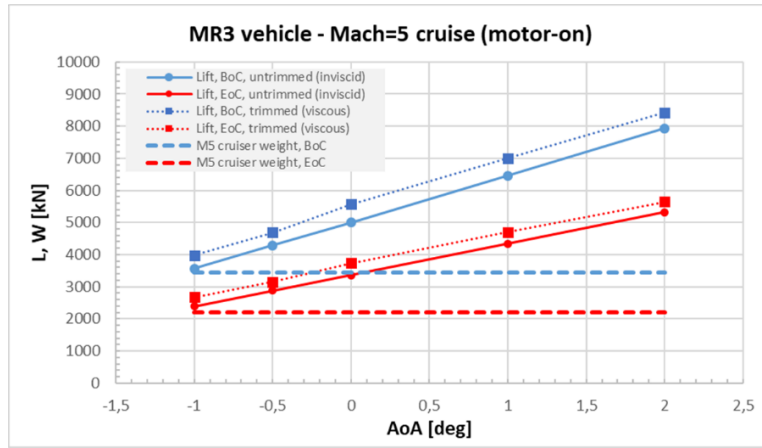

Figure 4 – Lift generated at Mach 5 for different vehicle weights (BoC – EoC) as function of Angle of Attack (AoA)

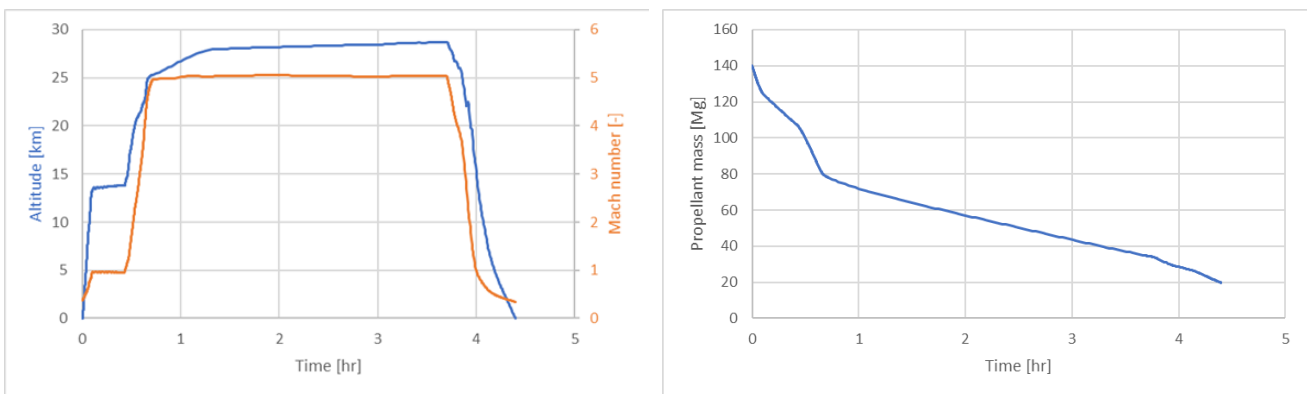

Figure 5 – Mach 5 mission with unchanged MR3 configuration (starting with 140 Mg of propellant)

Aerodynamic efficiency is also quite reduced during the acceleration phase, reaching a maximum value of about 5.5 in cruise, with respect to the original performance of about 7 at Mach 8. Efficiency reduction can be partially associated to the excess of spillage from the air intake, not designed and optimized for the Mach 5 steady and sustained flight. Even if the propellant consumption appears not to be a problem, the overall layout is inefficient, featuring unbalanced lifting surface, excessive volume and showing problems on the intake as well as on the nozzle sides, where the latter has lost its own adaptation point too. Even if the mission requirements appear to be met, a re-design of the vehicle layout is needed to correct the inconsistencies on main performance coming out because of the modification of flight regime and mission profile. Section 2.4 deals with aerodynamic as well as propulsive investigations and suggestions aimed at producing a consistent update to the layout, which is then synthesized in Section 2.5.

## 2.4 Re-design to meet Mach 5 requirements

### 2.4.1 Aerodynamic investigations and suggestions

As incremental step towards the identification of more consistent aerodynamic performance for the modified Mach 5 layout, some preliminary estimations on the air intake spillage mitigation can be introduced to partially correct the mission analysis results, driving the next re-design stages. In fact, a well-designed intake for Mach 5 cruise flight would reduce the spillage problem affecting the original Mach 8 configuration, as shown in Figure 6, where a comparison between the computed spillage laws of MR3 and MR5 vehicles is reported. Figure 7 shows also a comparison of aerodynamic characteristics (lift and drag coefficients) for both the original and the hypothetical new configuration.

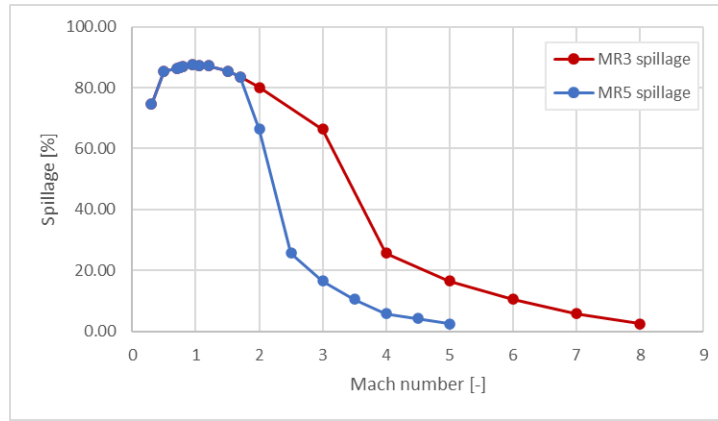

Figure 6 – Spillage for MR3 and MR5 vehicles

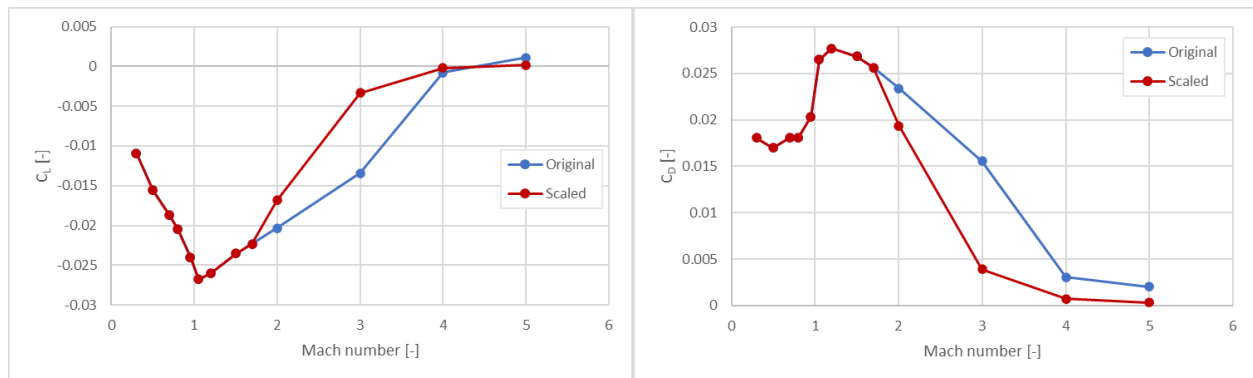

Figure 7 – Aerodynamic coefficients comparison between original and scaled intake for internal flow path

With the aforementioned hypotheses, while maintaining the original vehicle configuration (MR3), a slight increase in aerodynamic performance can be expected, even if, considering that the overall dimensions are still unchanged, the situation is similar to the one described in Section 2.3. Particularly, while altitude and Mach number profiles are very close to those reported in Figure 5, a small enhancement of propellant consumption and aerodynamic efficiency can be noticed. Figure 8 shows the trends for the original intake (same as before, labelled as “optimized @ Mach 8”) and the updated one (labelled as “optimized @ Mach 5”).

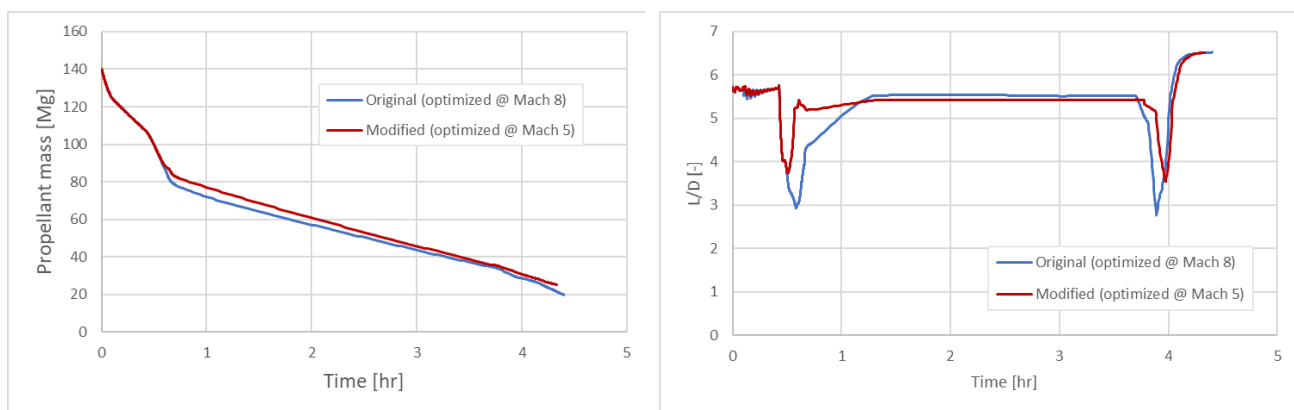

Figure 8 – Expected effect of the reduction of spillage phenomena for the air intake

The vehicle appears in any case still unbalanced, since lifting surface as well as internal volume appear too large. It is also clear how the size of the intake needs to be changed in a considerable way to see a relevant contribution to the performance (Section 2.4.2). Moreover, it is also reasonable to understand how the nozzle is experiencing an overexpansion, considering the reduced altitude at which it is now operating. Numerical simulations have been conducted on a full-scale configuration of MR3 vehicle considering both the external and the internal flow paths and, in addition, a simplified 3D/1D coupling of the hydrogen combustion by means of a slot inserted in the combustion chamber

## HYPERSONIC AIRCRAFT AND MISSION CONCEPT RE-DESIGN TO MOVE FROM MACH 8 TO MACH 5

(see Figure 9). In this way it is possible to consider the interaction of the internal flow expanding through the nozzle and the external flow coming from the fuselage, thus predicting the uncorrected expansion (over-expansion) that happens in this nozzle at the MR5 cruise conditions (Mach=5, altitude=25 km).

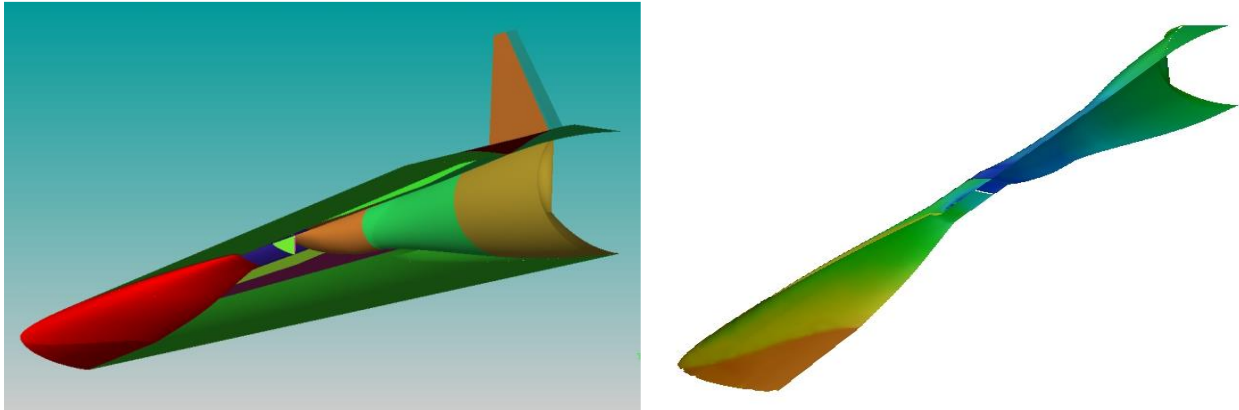

Figure 9 – STRATOFly MR3 vehicle (half part on the left) and internal pressure distribution for M=5 far field conditions

Numerical simulation shows that at Mach 5 and an altitude of 25 km the nozzle is contributing to thrust generation up to an horizontal coordinate of about 74 m (with reference to vehicle length), whilst the remaining part is useless, conversely producing drag as it can be seen clearly from the trend of distributed thrust (Figure 10-left).

This is due essentially to the fact that at these cruise conditions the far field pressure is higher than the one of the original STRATOFly MR3 vehicle (conceived to fly up to 35 km) and the nozzle is now over-expanded. The result of this analysis is that the original nozzle can be reduced of about 20 m, while ensuring a consistent cross-section.

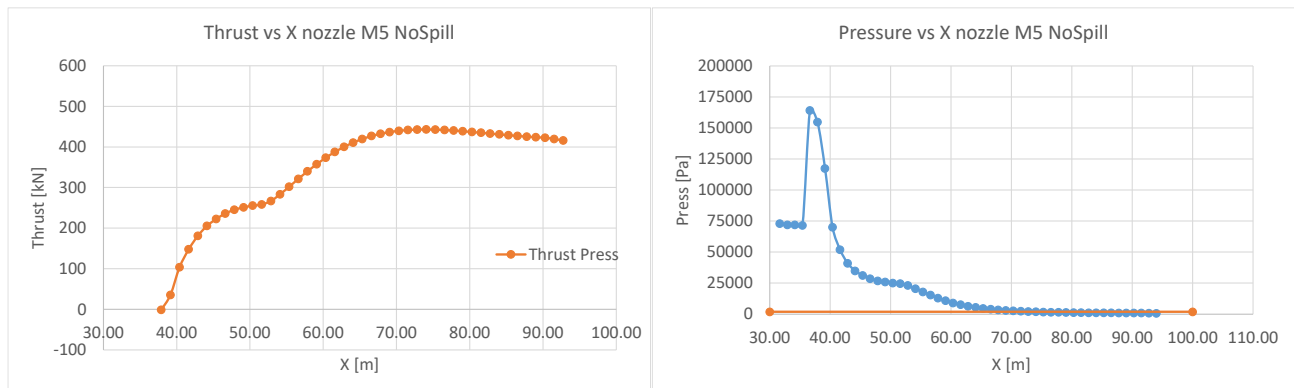

Figure 10 – Distributed thrust and section-average pressure along the nozzle at M=5 for MR3 vehicle

### 2.4.2 Propulsive Investigations and suggestions

Ramjet/scramjet propulsion is commonly preferred to power supersonic & hypersonic vehicles for cruising faster than Mach 3. This is an elegant solution owing to the lean architecture which does not embody any rotating parts. Although the geometry of the engine is simple as compared to turbo-based engines, the flow physics through the engine duct is quite complex and the flow speeds modulate between the supersonic and subsonic regimes more than one time. The design and performance analysis of such engine configurations are vital to make sure that propulsion systems can satisfy the flight trajectory requirements. Accordingly, a low fidelity design and analysis methodology is used to investigate the propulsive performance characterizations of different design choices on intake configurations providing complete propulsive flow path simulations via subsonic combustion, thermal choke phenomena and ideal expansion through the nozzle. Utilizing this methodology not only enables the performance characteristics of the intake designs to be assessed in terms of propulsive performance but also provides the geometric specifications of the relevant design choices. Preliminary results of this approach are reported in Table 1.

Table 1 - performance and geometric specifications of the re-designed intakes for MR5 with weak shock (WS) and strong shock (SS) configurations in comparison to MR3

Config	$M_\infty$	$M_i$	$P_i$	$T_i$	$\rho_i$	$V_i$	MFR	$A_{exit}$	$A_{inlet}$	$L_{intake}$	Contraction ratio
[-]	[-]	[-]	[Pa]	[K]	[Kg/m <sup>3</sup> ]	[m/sec]	[Kg/sec]	[m <sup>2</sup> ]	[m <sup>2</sup> ]	[m]	[-]
MR3	5.00	2.36	50492	535	0.329	1095	1670	4.86	60.8	30.4	12.5
MR5 WS	5.00	3.10	31.5	455	0.241	1231	1553	4.86	42.8	21.7	8.8
MR5 SS	5.00	0.56	495	1275	1.351	401	2632	4.86	41.9	18.5	8.6

In this case, an average reduction of intake length of about 10 m can be expected with reference to the original length of 30.4 m (notably, the computation leads to 21.7 m for WS and to 18.5 m for SS). Reference inlet surface is also updated accordingly, while outlet surface is constrained by isolator and combustor geometries.

### 2.5 Design Synthesis

The analyses described in Section 2.4 show that a sort of scaling process appears required in order to reduce vehicle dimensions, especially if the considered cruise altitude is reduced. However, since the concept of MR3 is still theoretically valid, considering that the overall mission objectives can be reached, even with less efficiency, the overall configuration can be maintained, with few exceptions. Two different approaches can be applied to scale down the vehicle, while minimizing the modifications to the original configuration: the homogeneous scaling and the 1D scaling. The first approach consists in selecting a linear scaling factor to be applied to vehicle dimensions in all directions (x, y, z) so to freeze the configuration while reducing progressively the overall layout. The second approach is instead focused on applying a linear scaling factor uniquely to the x dimension, in order to reduce vehicle length only. This process, however, produces a different vehicle configuration, since y and z dimensions are not updated. As quick reference to visualize the effect of both scaling opportunities, Figure 11 show the top view of the scaled layouts with reference to the original MR3 geometry. The selected scaling factor is 0.68, so to match with the reduced length of 64 m, suggested by aerodynamic and propulsive analyses (30 m reduction in total with reference to the original MR3 vehicle).

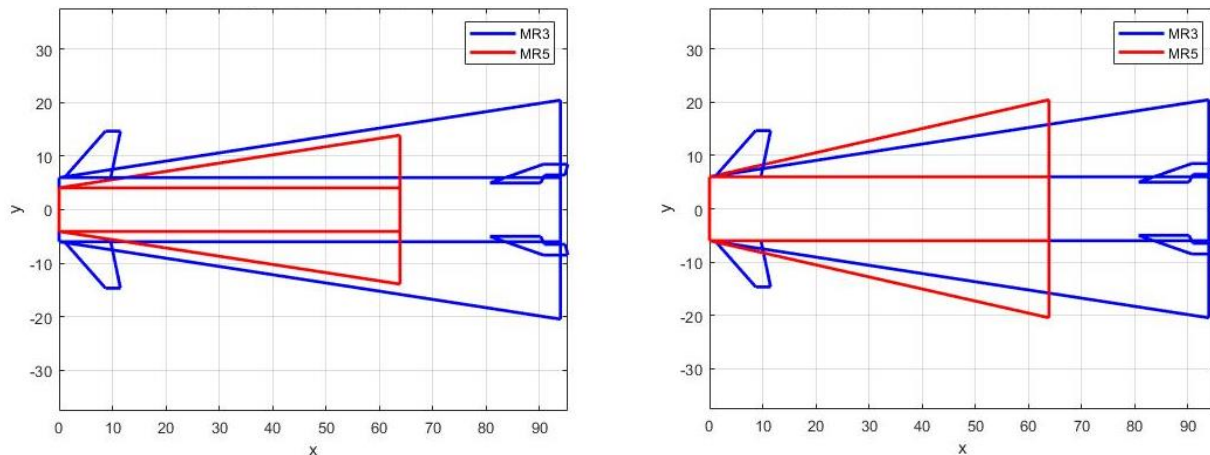

Figure 11 – Top view of the MR5 scaled layouts (left – homogeneous scaling, right – 1D scaling) with reference to the original MR3 geometry

As already stated, the homogeneous scaling approach has the advantage of keeping the very same

## HYPERSONIC AIRCRAFT AND MISSION CONCEPT RE-DESIGN TO MOVE FROM MACH 8 TO MACH 5

configuration of the aircraft, thus maintaining aerodynamic performance index unchanged. However, vehicle volume experience a fast reduction as function of the scaling factor, being proportional to its cubic power. At the same time, aerodynamic balance problems seen in cruise for the original layout are expected to be still present for this scaled version, since the overall mass, which is function of the volume through density parameter, reduces faster than the lifting surface (that in turn is proportional to the square power of the linear scaling factor) because of the so-called square-cubic law effect. Ultimately, the homogeneous scaling process simply moves the problems associated to propulsive flow path towards smaller dimensions, while keeping issues related to excessive lengths of intake and nozzle elements (since the overall proportions are untouched). On the other hand, the 1D scaling process produces a different vehicle configuration, exploiting a reduced slenderness since the overall length is reduced, but the wingspan remains the same. Reduction of main surfaces and volumes are, in this case, a linear function of the linear scaling factor, since only x dimension is influenced by the scaling. Volume reduction is also slower with reference to the surface, while some configuration parameters are also changed (such as the wing sweep angle). It is also clear that, even if not reported in Figure 11, canard and vertical tails shall be updated accordingly (they cannot be scaled in a homogeneous way since their mutual position with reference to the CoG will have different proportions if compared to the original layout). As comparative means, the following charts provides some examples of the influence of the selected scaling approach on main configuration variables and performance, considering a 0.68 linear scaling factor (corresponding value marked with a red star). Figure 12 shows the trend related to payload reduction as function of the scaling. An original value of 300 passengers and  $1200 \text{ m}^3$  cabin has been considered, leading to a volume-passenger ratio of about  $4 \text{ m}^3$  per passenger. Scaled variables have been obtained considering a volume reduction consistent with the selected approach.

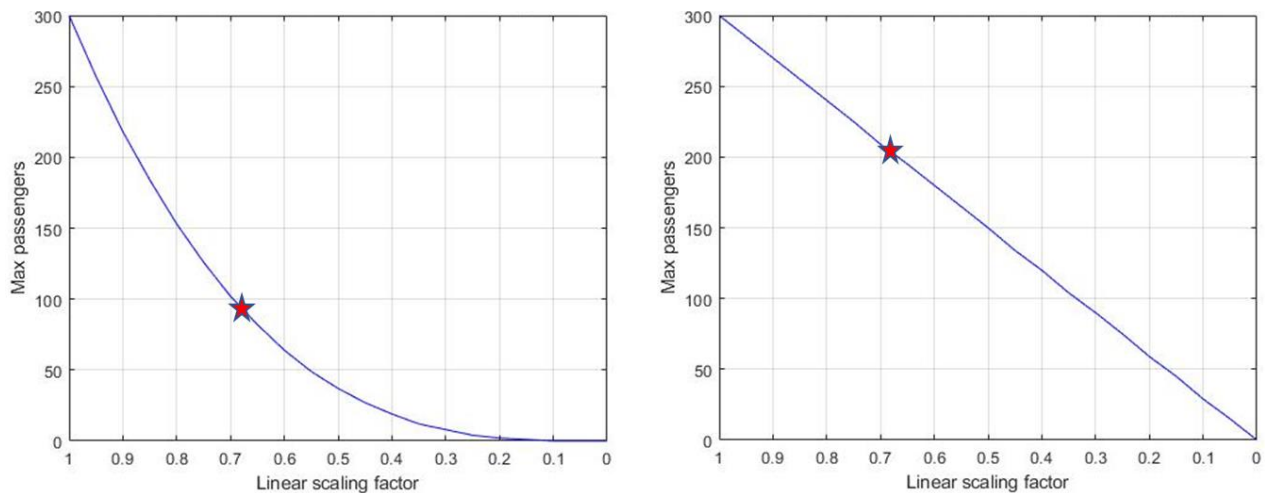

Figure 12 – Payload reduction as function of scaling approach (left – homogeneous scaling, right – 1D scaling)

A similar approach has been adopted to estimate maximum storable propellant mass (Figure 13), considering an original LH2 capacity of about  $2000 \text{ m}^3$  for the original layout and two different scenarios for cryogenic storage technology (low density –  $70.8 \text{ kg/m}^3$ , high density -  $90 \text{ kg/m}^3$ ).

**HYPERSONIC AIRCRAFT AND MISSION CONCEPT RE-DESIGN TO MOVE FROM MACH 8 TO MACH 5**

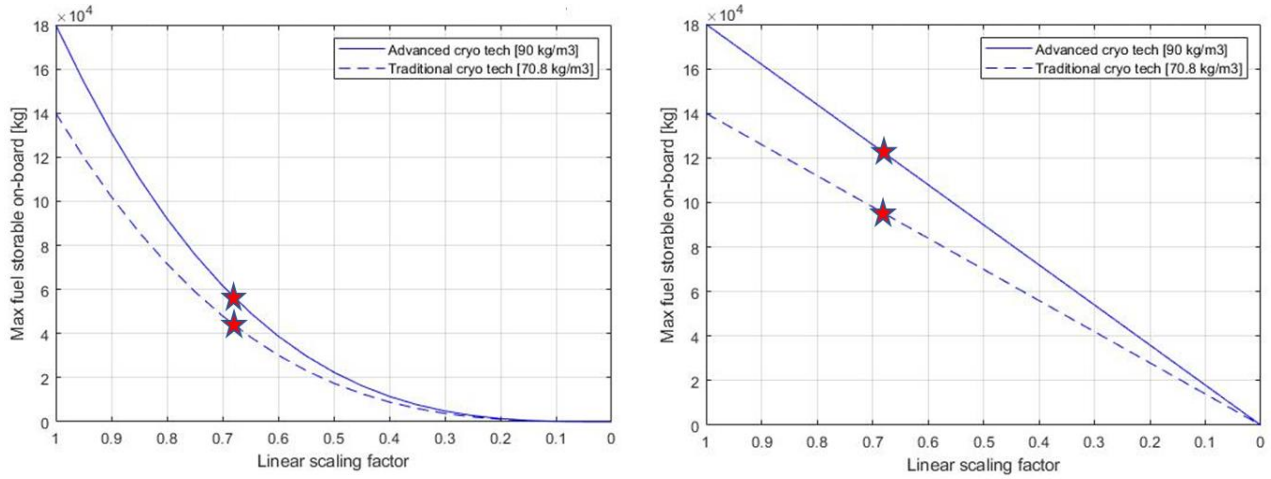

Figure 13 – Propellant mass storage reduction as function of the scaling approach (left – homogeneous scaling, right – 1D scaling)

Overall volume and planform vehicle surface (Figure 14) are obtained similarly, considering an original volume capacity of about  $10000\text{ m}^3$  and a reference surface of  $2491\text{ m}^2$  for the MR3.

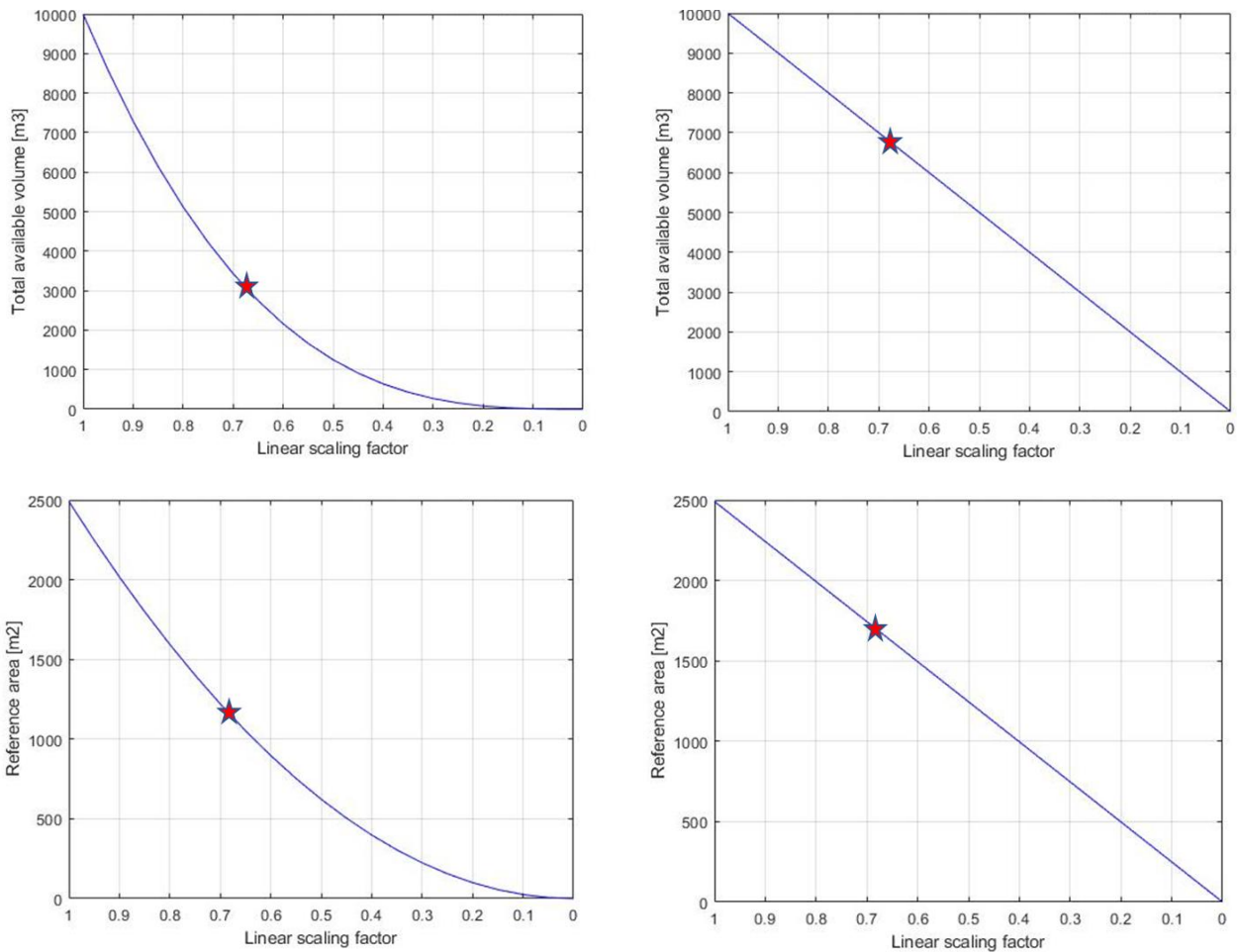

Figure 14 – Available volume (top) and vehicle planform surface (bottom) as function of the scaling approach (left – homogeneous scaling, right – 1D scaling)

Mass trends for what concerns Operating Empty Weight (OEW) and Gross Take-Off mass (GTO) are then obtained (Figure 15) as function of aforementioned variables, considering a reference OEW equal to 187 Mg and a Maximum Take-Off Weight (MTOW) equal to 400 Mg for the MR3 exploiting high density LH2 storage and max payload.

## HYPERSONIC AIRCRAFT AND MISSION CONCEPT RE-DESIGN TO MOVE FROM MACH 8 TO MACH 5

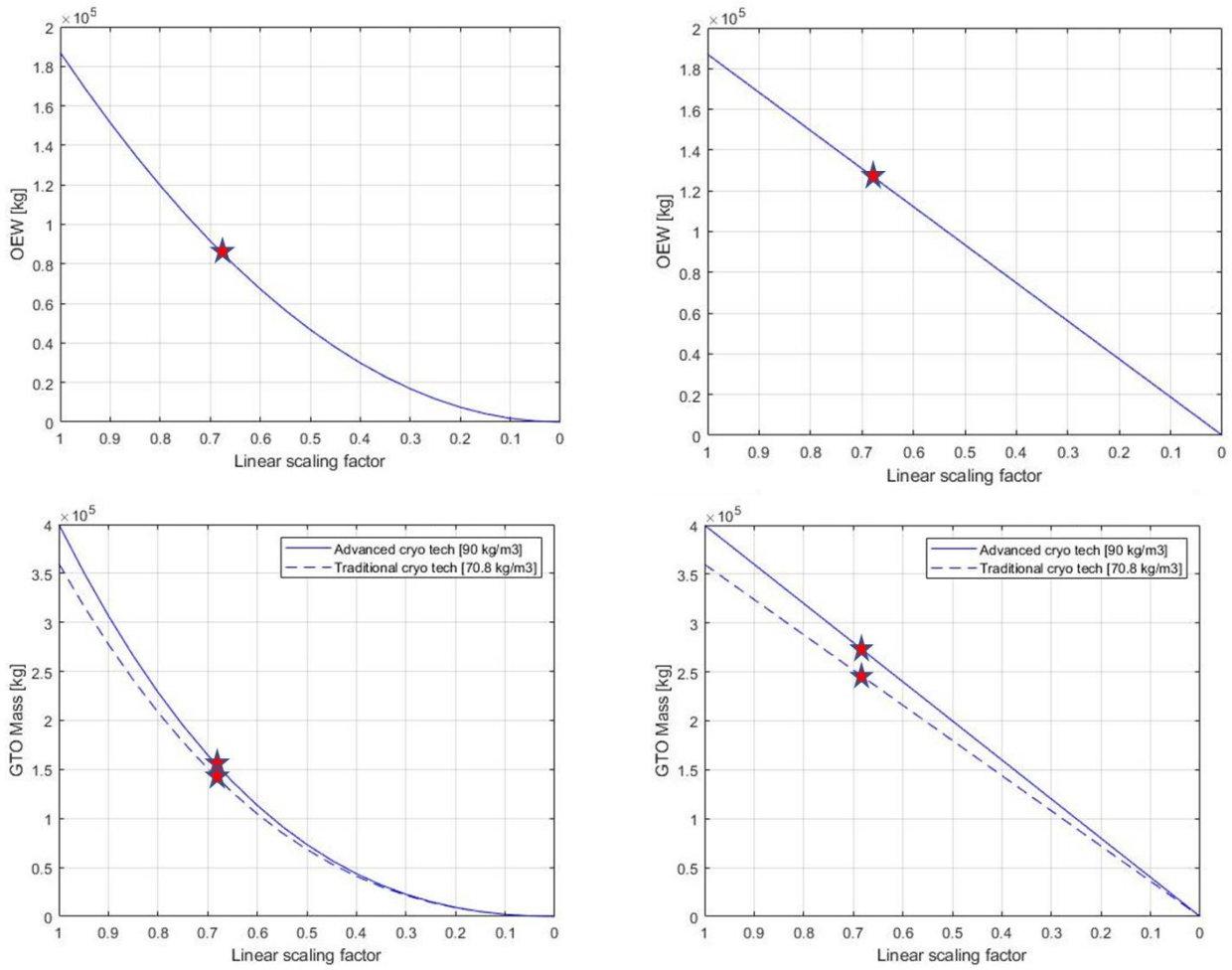

Figure 15 – OEW (top) and GTO mass (bottom) as function of the scaling approach (left – homogeneous scaling, right – 1D scaling)

A simple estimation of the available range can be also made for both scaled configurations, exploiting literature models for high-speed vehicles. Particularly, the model proposed in [10] is used for the computation of the equivalent all-out range (thus including losses for subsonic legs and maneuvers) as shown in (1).

$$R = R_h \eta_0 \frac{L}{D} \log\left(\frac{W_i}{W_e}\right) + 0.2R_h \quad (1)$$

As far as homogeneous scaled configuration is concerned, the following parameters have been considered:

$\frac{L}{D} = 5.4$  is the aerodynamic efficiency

$\eta_0 = 0.55$  is the propulsive efficiency

$H = 120 \frac{MJ}{kg}$  is the calorific energy of the LH2

$R_h = \frac{H}{g} = 12232 \text{ km}$  is the reference range for LH2 obtained as ratio between  $H$  and gravity acceleration  $g$

Considering the lift excess in cruise, the reference attitude of  $-1^\circ$  AoA is considered for this phase. Figure 16 shows the results concerning the available range computation for this configuration.

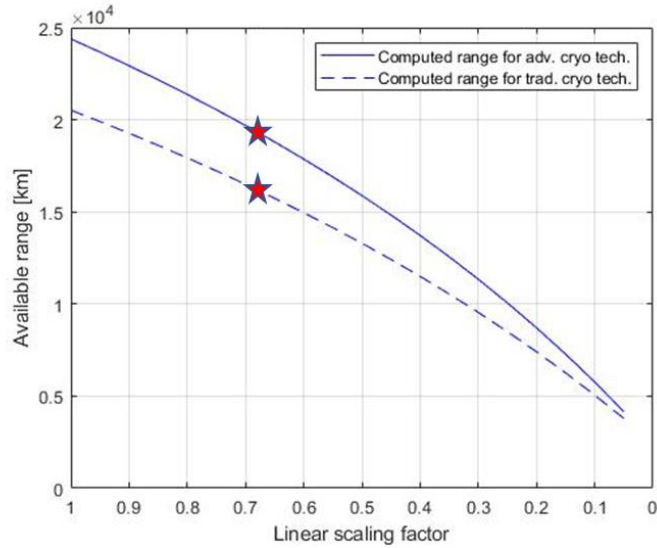

Figure 16 – Available range for homogeneous scaled MR5

A similar approach has been adopted for the 1D scaling scenario, while, in this case, some considerations have to be made concerning aerodynamic characterization of the vehicle. In fact, the modifications to the slenderness ratio of the vehicle may produce an effect on the theoretical aerodynamic efficiency in cruise. Literature models [11, 12] suggest a reduction of L/D as function of the Kuchemann parameter [13]  $\tau$  defined as in (2), where  $V_{tot}$  is the total available volume of the vehicle and  $S_{ref}$  is the reference planform surface.

$$\tau = \frac{V_{tot}}{S_{ref}^{1.5}} \quad (2)$$

The theoretical derivation [12] used to predict aerodynamic efficiency is provided in (3).

$$\frac{L}{D} = \frac{5(M_\infty + 2)}{M_\infty} \left( \frac{1.0128 - 0.2797 \log\left(\frac{\tau}{0.03}\right)}{1 - \frac{M_\infty^2}{673}} \right) \quad (3)$$

For the 1D scaling scenario, the  $\tau$  parameter moves from the original value of 0.08 to 0.1, with an expected reduction of aerodynamic efficiency (from 5.4 to 5) (Figure 17).

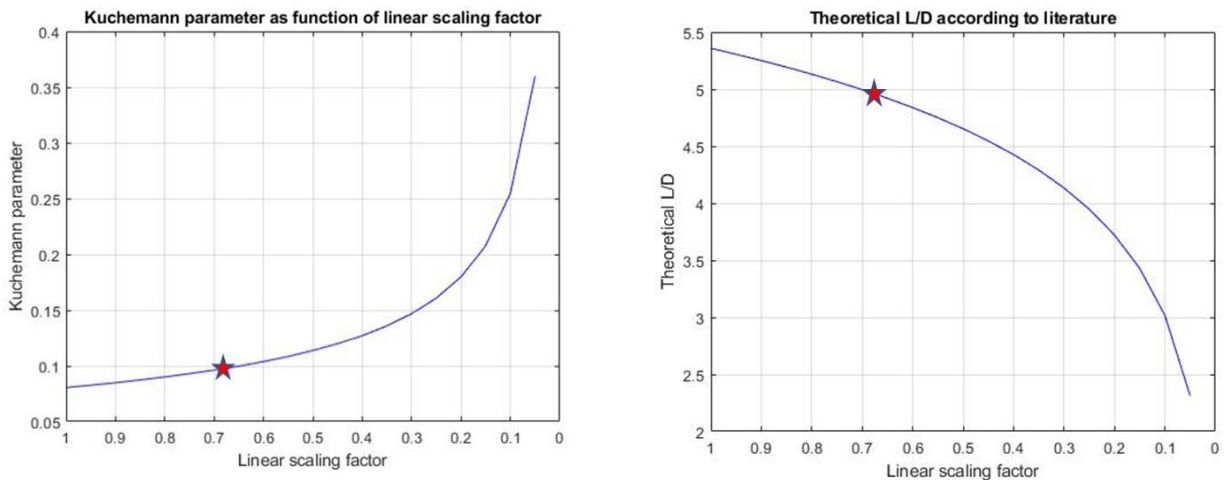

Figure 17 –  $\tau$  (left) and L/D (right) trends as function of scaling factor for 1D scaled MR5

Keeping the other parameters defined within (1), the available range trend changes as in Figure 18.

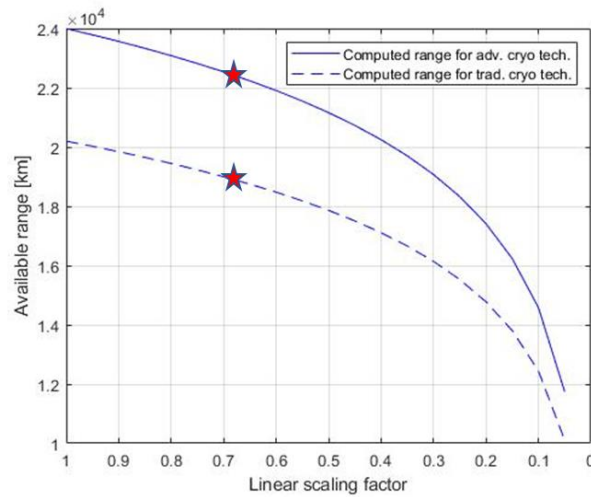

Figure 18 – Available range for 1D scaled MR5

It is possible to see how the reduction of vehicle length has a detrimental effect on the aerodynamic efficiency because of the reduction of its slenderness ratio, and, as consequence, of the raise of its  $\tau$  parameter.

Overall, the 1D scaled MR5 appears more promising in terms of aerodynamic balance, volume feasibility and range capability, while changes to the original configuration shall be carefully assessed in terms of aerodynamic and propulsive performance. This configuration is taken as reference for the analysis described in Section 3.

### 3. Mach 5 Vehicle concept validation

One of the first analyses to be carried out for the 1D scaled MR5 concerns the preliminary validation of the consistency of waverider surface with reference to the updated flow field and configuration. In fact, the MR3 layout appeared to be consistent with the modified mission, since it was conceived to reach Mach 8 while passing through different flight regimes (including Mach 5). On the contrary, the modified MR5 configuration is now different in terms of mutual proportions (even if updates are limited) and Mach 5 flight shall be then validated, with reference to waverider lifting geometry, at least with some preliminary approaches. As known, the waverider concept is designed as consequence of the shock wave profile encountered during flight, through a sort of reversed approach. A simple way to face the analysis relies on the parametrization of the flow field generated by the vehicle using literature models based on simple geometries. The so-called Taylor-Maccoll model [14, 15] exploits a 3D flow field generated by a cone having the same length of the desired vehicle and a diameter which is close to the maximum cross section of the aircraft. In this way, the generated flow field shall be, at least theoretically, similar to the one actually generated by the vehicle, being usable to validate the lifting surface shape (Figure 19). The Ordinary Differential Equation here reported (4) expresses the characteristics of the flow for a high supersonic/hypersonic inviscid flow past a cone with angle of attack of  $0^\circ$  with the assumptions of irrotational and isentropic flow:

$$\frac{\gamma - 1}{2} * \left[ V_{max} - v_r^2 - \left( \frac{dv_r}{d\theta} \right)^2 \right] * \left( 2 * v_r + \frac{dv_r}{d\theta} * \cot \theta + \frac{d^2 v_r}{d\theta^2} \right) - \frac{dv_r}{d\theta} * \left( v_r * \frac{dv_r}{d\theta} + \frac{dv_r}{d\theta} * \frac{d^2 v_r}{d\theta^2} \right) = 0 \quad (4)$$

where

$$v_\theta = \frac{dv_r}{d\theta} \quad (5)$$

and

$v_r$  is the radial component downstream the shock wave (radial velocity)

$v_\theta$  is the normal component of velocity downstream the shock wave (polar velocity)

$\theta$  and  $r$  are spherical coordinates

$\gamma$  is the heat capacity ratio.

This equation is a second order ordinary differential equation of the type  $V_r'' = f(V_r', V_r, \theta)$  that needs to be solved with numerical method imposing that  $v_\theta = 0$  to assure normal velocity on the cone surface.

Starting from equivalent vehicle length and cross-section, a generic cone can be defined and its semi-aperture angle can be easily quantified as in (6).

$$\delta = \text{atan}\left(\frac{R_{\text{cone}}}{L_{\text{cone}}}\right) \quad (6)$$

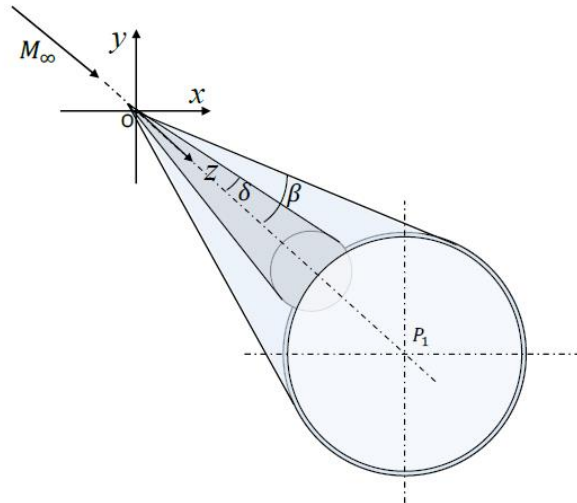

Figure 19 – Generating cone and generated shock according to [14] model

The main difference between the generating cone and the shock cone consists in the followings: the generating shock cone has a hypothetical infinite extension along the flow direction and it divides the design space in two different areas. Of course, only the region contained within the shock cone can be used to generate a feasible vehicle concept. The generation of the vehicle shape starts from sketching its planform area to make the leading edges lay directly on the shock surface, i.e. on the intersection of the cone with a plane parallel to the direction of the motion. Depending on the length, wingspan as well as on the constraints associated to trailing edge cross-section shape and dimensions, the vehicle contour can be translated in both horizontal and lateral views (Figure 20) in order to accommodate the leading edge on the shock wave, according to simple geometrical correlations.

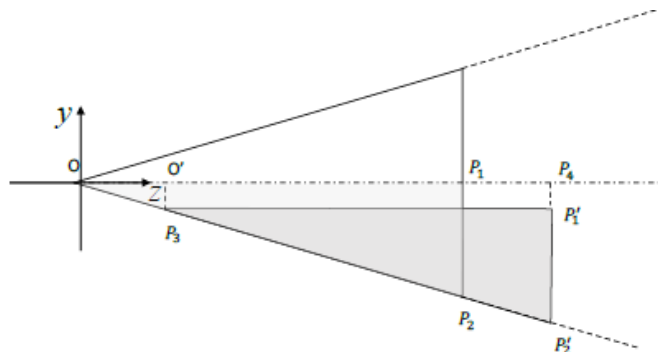

Figure 20 – Example of vehicle contour translation on lateral plane

With these assumptions, a reference vehicle envelope for the 1D scaled MR5 can be obtained, applying the following constraints:

- Mach number = 5
- Altitude = 25000 m

## HYPERSONIC AIRCRAFT AND MISSION CONCEPT RE-DESIGN TO MOVE FROM MACH 8 TO MACH 5

- Vehicle length = 64 m
- Vehicle reference height at maximum cross-section = 12.8 m
- Wingspan = 41 m
- Same geometrical constraints at trailing edge (consistent shape with original MR3)

The result concerning generated geometry is shown in Figure 21.

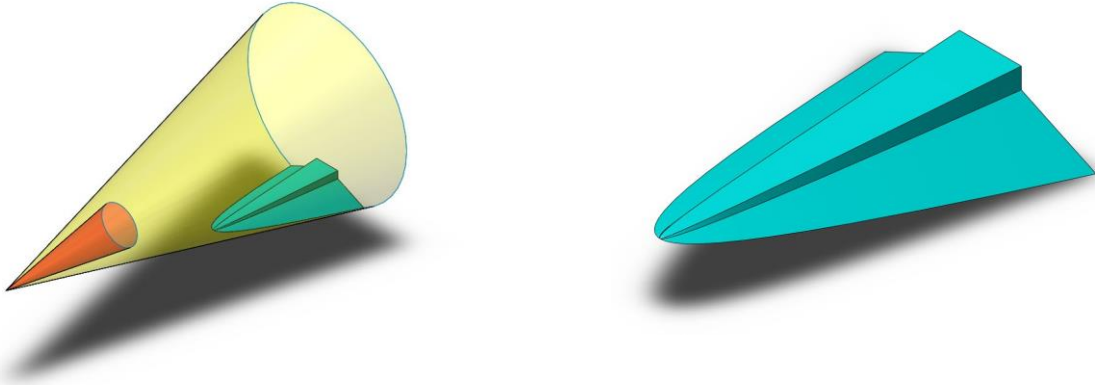

Figure 21 – Equivalent MR5 envelope (cyan) generated for 1D scaled approach using 3D cone generated shock

The envelope can then be compared with the MR5 1D scaled CAD model in order to verify the consistency of the new configuration with the flow field. As shown in Figure 22, the geometries are pretty much in line with each other, with the exception of the nose area, where the intake shape of MR3 cannot be represented by adopting the simple approach described above and relying on the 3D cone flow field. The same applies to canard and vertical tails, which are not included.

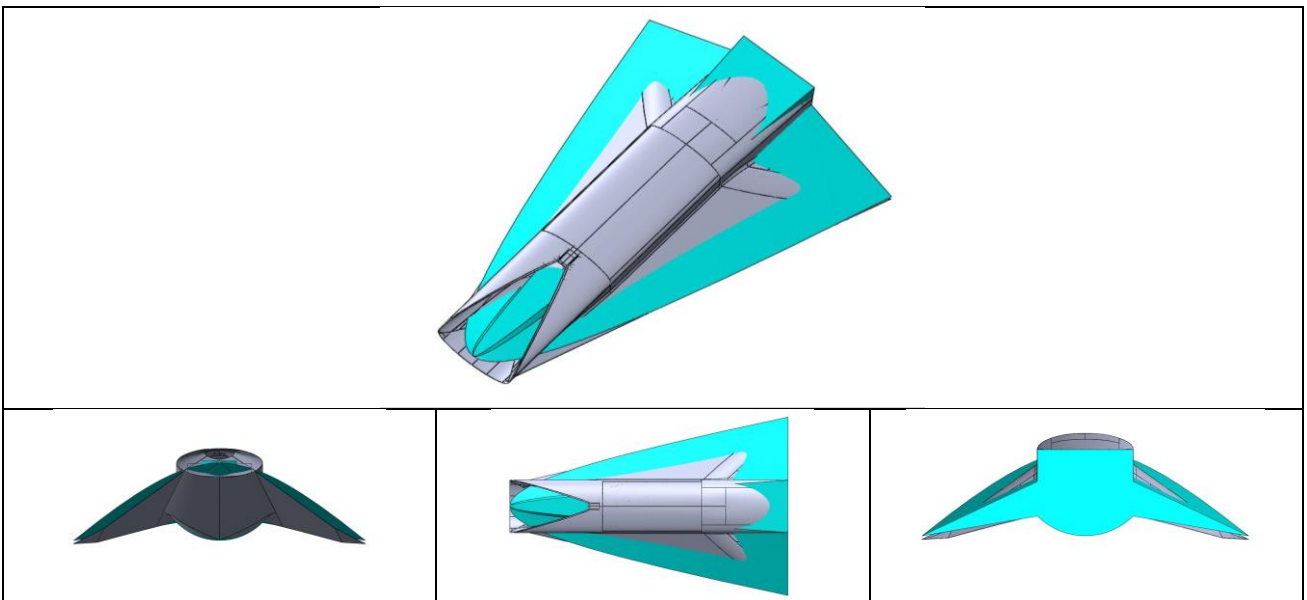

Figure 22 - Comparison between 1D scaled MR5 CAD (gray) and equivalent envelope (cyan - clean configuration)

This means that the configuration can be considered still consistent with the Mach 5 condition, with the updated waverider surface. The main reason for this consistency is that, even if the generating cone is different if considering MR3 and MR5 (for the 1D scaled configuration the ratio between length and height is changed), also taking into account the different design Mach, the conical shock wave angle is not so different. In fact, as reported in Figure 23 [16], a difference of less than  $10^\circ$  can be appreciated, considering also that, while raising the Mach number, the shock angle trends as function of cone angle are more and more similar (there is actually an oblique asymptote in the chart).

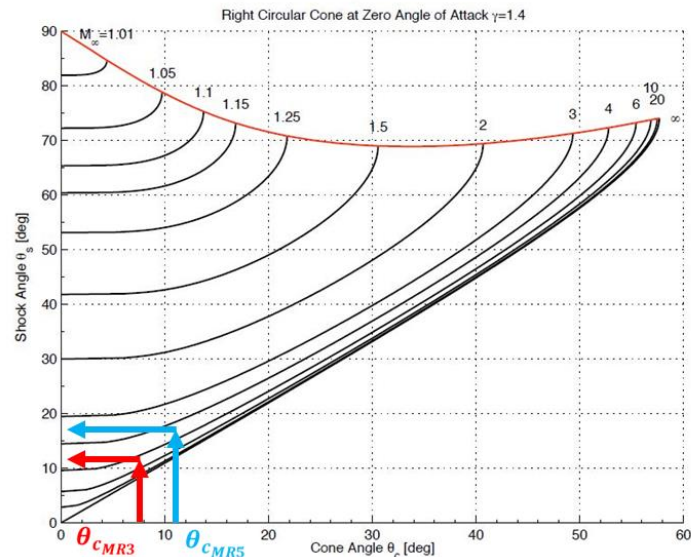

Figure 23 – Shock angle as function of cone angle for the 3D cone waverider generation process [16]

The 1D scaled MR5 configuration appears then still in line with expectations and it is possible to move forward with its characterization in terms of aerodynamic and propulsive performance.

#### 4. Conclusions and planned future activities

The proposed methodology provides guidelines to conceptually re-design a Mach 8 waverider concept to improve its efficiency when operating in subsonic and supersonic flight regimes, with Mach numbers from Mach 0.3 to Mach 5. An overview of the multidisciplinary design methodology to meet the challenging goal of re-designing a high-speed aircraft, integrating both aerodynamics and propulsive analyses (high-level, low fidelity), is proposed with focus on the design synthesis phase, where the requirements coming from the different disciplines are collected, the trade-off process is performed and the selection of the alternative designs is made. A typical validation attempt for waverider architecture is provided, showing consistency of the result with the initial requirements, in terms of configuration. Analyses concerning overall aerodynamic performance shall also be conducted in order to characterize in more details the envisaged concept. In fact, the characterization of both aerodynamic and propulsive databases will be the starting point for the implementation of the baseline mission simulation, used to verify vehicle performance with reference to high-level concept requirements. In fact, as example, propulsive performance maps of the ramjet engine are significant to comprehend engine behavior in terms of thrust, specific impulse and fuel consumption during the off-design flight phases, with a direct impact on intake aerodynamic performance. Future works shall then deal firstly with the definition of proper mission analyses based on the low fidelity results just derived, progressively moving towards the usage of high-fidelity aero-propulsive data, aiming for an iterative mission definition process.

#### Acknowledgment

This work has been carried out within the frame of “MDO and REgulations for Low boom and Environmentally Sustainable Supersonic aviation” (MORE&LESS) project. This project has received funding from the European Union’s Horizon 2020 research and innovation program under grant agreement No 101006856.

#### Contact Author Email Address

Davide Ferretto, PhD

Assistant Professor, Department of Mechanical and Aerospace Engineering (DIMEAS)

Politecnico di Torino

Mail: [davide.ferretto@polito.it](mailto:davide.ferretto@polito.it)

## Copyright Statement

The authors confirm that they, and/or their company or organization, hold copyright on all of the original material included in this paper. The authors also confirm that they have obtained permission, from the copyright holder of any third party material included in this paper, to publish it as part of their paper. The authors confirm that they give permission, or have obtained permission from the copyright holder of this paper, for the publication and distribution of this paper as part of the ICAS proceedings or as individual off-prints from the proceedings.

## References

- [1] <https://cordis.europa.eu/project/id/101006856> . Accessed 31/01/2022.
- [2] Viola, N., Fusaro, R. and Vercella, V., Technology roadmapping methodology for future hypersonic transportation systems. *Acta Astronautica*, Vol 195, pp. 430-444, 2022. <https://doi.org/10.1016/j.actaastro.2022.03.038>
- [3] Viola, N., et al., “H2020 STRATOFly Project : from Europe to Australia in less than 3 hours”, *32nd Congress of the International Council of the Aeronautical Sciences*, Shanghai, CN, 2021.
- [4] Viola N., et al., STRATOFly MR3 – How to reduce the environmental impact of high-speed transportation. *Proceedings of the AIAA Scitech Forum*, 2021. <https://doi.org/10.2514/6.2021-1877>
- [5] Viola N., et al., Main Challenges and Goals of the H2020 STRATOFly Project. *Aerotecnica Missili & Spazio*, Vol 100, pp. 95-110, 2021. <https://doi.org/10.1007/s42496-021-00082-6>
- [6] Viola, N., Roncioni, P., Gori, O., and Fusaro, R., “Aerodynamic Characterization of Hypersonic Transportation Systems and Its Impact on Mission Analysis”, *Energies*, Vol. 14, N. 3590, 2021. <https://doi.org/10.3390/en14123580>
- [7] Ferretto, D., Fusaro, R. and Viola, N., Innovative Multiple Matching Charts approach to support the conceptual design of hypersonic vehicles. *Proceedings of the Institution of Mechanical Engineers Part G: Journal of Aerospace Engineering*, Vol 234 (12), pp. 1893-1912, 2020. <https://doi.org/10.1177/0954410020920037>
- [8] Fusaro, R.; Gori, O., Ferretto, D.; Viola, N., Roncioni, P. and Marini, M., “Integration of an increasing fidelity aerodynamic modelling approach in the conceptual design of hypersonic cruiser”, *32nd Congress of the International Council of the Aeronautical Sciences*, Shanghai, CN; 2021.
- [9] Goncalves, P. M., Ispir, A. C. and Saracoglu, B. H., Development and optimization of a hypersonic civil aircraft propulsion plant with regenerator system, *AIAA Propulsion and Energy 2019 Forum*, Indianapolis (IN), USA, 2019 <https://doi.org/10.2514/6.2019-4421>
- [10] Torenbeek, E., *Essentials of Supersonic Commercial Aircraft Conceptual Design*. 1<sup>st</sup> Edition, Edited by P. Belobaba, J. Cooper, A. Seabridge, Aerospace Series, John Wiley & Sons Ltd. Hoboken (NJ), USA, 2020. ISBN: 978-1-119-66700-1
- [11] Ferretto, D., Fusaro, R. and Viola, N., A conceptual design tool to support high-speed vehicle design, *AIAA Aviation 2020 Forum*, 2020 <https://doi.org/10.2514/6.2020-2647>
- [12] Ingenito, A., Bruno, C. and Gulli, S., Preliminary Sizing of Hypersonic Airbreathing Airliner, *Transaction of the Japan Society of Aeronautical and Space Sciences*, Aerospace Technology Japan, 2010.
- [13] Kuchemann, D., *The Aerodynamic Design of Aircraft*, AIAA, Reston (VA), USA, 2012 <https://doi.org/10.2514/4.869228>
- [14] Maccoll, J.W., The conical shock wave formed by a cone moving at a high speed. *Proceedings of the Royal Society*, London, A 159, pp. 459–472, 1937 <https://doi.org/10.1098/rspa.1937.0083>
- [15] Forbes, L., K. and Hindle, Closed-form approximation for supersonic flow over a cone, *Shock Waves*, 29.4, pp. 589-593, 2019 [10.1007/s00193-018-0879-0](https://doi.org/10.1007/s00193-018-0879-0)
- [16] Lassaline, J. V., Supersonic right circular cone at zero angle of attack, Ryerson University, 2019.