

Experimental demonstration of flexible bandwidth networking with real-time impairment awareness

*Original*

Experimental demonstration of flexible bandwidth networking with real-time impairment awareness / Geisler, Dj; Proietti, R; Yin, Yw; Scott, Rp; Cai, Xr; Fontaine, Nk; Paraschis, L; Gerstel, O; Yoo, Sjb. - In: OPTICS EXPRESS. - ISSN 1094-4087. - 19:26(2011), pp. 736-745. [10.1364/OE.19.00B736]

*Availability:*

This version is available at: 11583/2972459 since: 2022-10-19T14:38:39Z

*Publisher:*

Optical Society of America

*Published*

DOI:10.1364/OE.19.00B736

*Terms of use:*

This article is made available under terms and conditions as specified in the corresponding bibliographic description in the repository

*Publisher copyright*

Optica Publishing Group (formely OSA) postprint versione editoriale con OAPA (OA Publishing Agreement)

© 2011 Optica Publishing Group. Users may use, reuse, and build upon the article, or use the article for text or data mining, so long as such uses are for non-commercial purposes and appropriate attribution is maintained. All other rights are reserved.

(Article begins on next page)

# Experimental demonstration of flexible bandwidth networking with real-time impairment awareness

David J. Geisler,<sup>1</sup> Roberto Proietti,<sup>1</sup> Yawei Yin,<sup>1</sup> Ryan P. Scott,<sup>1</sup> Xinran Cai,<sup>1</sup> Nicolas K. Fontaine,<sup>1</sup> Loukas Paraschis,<sup>2</sup> Ori Gerstel,<sup>2</sup> and S. J. B. Yoo<sup>1,\*</sup>

<sup>1</sup>Department of Electrical and Computer Engineering, University of California, Davis, One Shields Ave., Davis, California, 95616, USA

<sup>2</sup>Cisco Systems, 170 W. Tasman Dr., San Jose, CA 95134 USA

\*sbyoo@ucdavis.edu

**Abstract:** We demonstrate a flexible-bandwidth network testbed with a real-time, adaptive control plane that adjusts modulation format and spectrum-positioning to maintain quality of service (QoS) and high spectral efficiency. Here, low-speed supervisory channels and field-programmable gate arrays (FPGAs) enabled real-time impairment detection of high-speed flexible bandwidth channels (flexpaths). Using premeasured correlation data between the supervisory channel quality of transmission (QoT) and flexpath QoT, the control plane adapted flexpath spectral efficiency and spectral location based on link quality. Experimental demonstrations show a back-to-back link with a 360-Gb/s flexpath in which the control plane adapts to varying link optical signal to noise ratio (OSNR) by adjusting the flexpath's spectral efficiency (i.e., changing the flexpath modulation format) between binary phase-shift keying (BPSK), quaternary phase-shift keying (QPSK), and eight phase-shift keying (8PSK). This enables maintaining the data rate while using only the minimum necessary bandwidth and extending the OSNR range over which the bit error rate in the flexpath meets the quality of service (QoS) requirement (e.g. the forward error correction (FEC) limit). Further experimental demonstrations with two flexpaths show a control plane adapting to changes in OSNR on one link by changing the modulation format of the affected flexpath (220 Gb/s), and adjusting the spectral location of the other flexpath (120 Gb/s) to maintain a defragmented spectrum.

©2011 Optical Society of America

**OCIS codes:** (060.4264) Networks, wavelength assignment; (060.1155) All-optical networks.

---

## References and links

1. M. Jinno, B. Kozicki, H. Takara, A. Watanabe, Y. Sone, Y. Tanaka, and A. Hirano, "Distance-adaptive spectrum resource allocation in spectrum-sliced elastic optical path network," *IEEE Commun. Mag.* **48**(8), 138–145 (2010).
2. C. V. Saradhi and S. Subramaniam, "Physical layer impairment aware routing (PLIAR) in WDM optical networks: issues and challenges," *IEEE Commun. Surveys Tutorials* **11**(4), 109–130 (2009).
3. Z. Pan, C. Yu, and A. E. Willner, "Optical performance monitoring for the next generation optical communication networks," *Opt. Fiber Technol.* **16**(1), 20–45 (2010).
4. A. E. Willner, "The optical network of the future: can optical performance monitoring enable automated, intelligent and robust systems?" *Opt. Photonics News* **17**(3), 30–35 (2006).
5. D. C. Kilper, R. Bach, D. J. Blumenthal, D. Einstein, T. Landolsi, L. Ostar, M. Preiss, and A. E. Willner, "Optical performance monitoring," *J. Lightwave Technol.* **22**(1), 294–304 (2004).
6. S. Azodolmolky, J. Perello, M. Angelou, F. Agraz, L. Velasco, S. Spadaro, Y. Pointurier, A. Francescon, C. V. Saradhi, P. Kokkinos, E. A. Varvarigos, S. Al Zahr, M. Gagnaire, M. Gunkel, D. Klonidis, and I. Tomkos, "Experimental demonstration of an impairment aware network planning and operation tool for transparent/translucent optical networks," *J. Lightwave Technol.* **29**(4), 439–448 (2011).

7. M. Gagnaire and S. Zahr, "Impairment-aware routing and wavelength assignment in translucent networks: state of the art," *IEEE Commun. Mag.* **47**(5), 55–61 (2009).
8. D. J. Geisler, R. Proietti, Y. Yin, R. P. Scott, X. Cai, N. K. Fontaine, L. Paraschis, O. Gerstel, and S. J. B. Yoo, "The first testbed demonstration of a flexible bandwidth network with a real-time adaptive control plane," in *37th European Conference and Exposition on Optical Communications*, OSA Technical Digest (CD) (Optical Society of America, 2011), paper Th.13.K.2.
9. R. P. Scott, N. K. Fontaine, J. P. Heritage, and S. J. B. Yoo, "Dynamic optical arbitrary waveform generation and measurement," *Opt. Express* **18**(18), 18655–18670 (2010).
10. D. J. Geisler, N. K. Fontaine, R. P. Scott, and S. J. B. Yoo, "Demonstration of a flexible bandwidth optical transmitter/receiver system scalable to terahertz bandwidths," *IEEE Photonics J.* **3**(6), 1013–1022 (2011).
11. N. K. Fontaine, R. P. Scott, L. Zhou, F. M. Soares, J. P. Heritage, and S. J. B. Yoo, "Real-time full-field arbitrary optical waveform measurement," *Nat. Photonics* **4**(4), 248–254 (2010).
12. B. Kozicki, H. Takara, Y. Tsukishima, T. Yoshimatsu, K. Yonenaga, and M. Jinno, "Experimental demonstration of spectrum-sliced elastic optical path network (SLICE)," *Opt. Express* **18**(21), 22105–22118 (2010).
13. F. Paolucci, N. Sambo, F. Cugini, A. Giorgetti, and P. Castoldi, "Experimental demonstration of impairment-aware PCE for multi-bit-rate WSONs," *J. Opt. Commun. Networking* **3**(8), 610–619 (2011).
14. Y. Lee, G. Bernstein, D. Li, and G. Martinelli, "A framework for the control of wavelength switched optical networks (WSON) with impairments," *IETF Internet Draft* (Nov. 23, 2011).
15. D. J. Geisler, N. K. Fontaine, T. He, R. P. Scott, L. Paraschis, J. P. Heritage, and S. J. B. Yoo, "Modulation-format agile, reconfigurable Tb/s transmitter based on optical arbitrary waveform generation," *Opt. Express* **17**(18), 15911–15925 (2009).
16. T. Sakamoto, T. Kawanishi, and M. Izutsu, "Asymptotic formalism for ultraflat optical frequency comb generation using a Mach-Zehnder modulator," *Opt. Lett.* **32**(11), 1515–1517 (2007).
17. C. Dorrer, C. R. Doerr, I. Kang, R. Ryf, J. Leuthold, and P. J. Winzer, "Measurement of eye diagrams and constellation diagrams of optical sources using linear optics and waveguide technology," *J. Lightwave Technol.* **23**(1), 178–186 (2005).

---

## 1. Introduction

Flexible bandwidth networking provides an effective way of scaling existing networks to more efficiently utilize available spectral resources [1]. Specifically, flexible bandwidth networking enables multiple variable bandwidth traffic demands to be satisfied simultaneously using variable bandwidth channels that can each use one of many possible modulation formats. In this way allocated bandwidth is efficiently matched to traffic demand while also overcoming spectral efficiency limitations caused by spectral gaps between WDM channels on the ITU grid. In some cases, the arbitrary bandwidth channels occupy large bandwidths (> 100 GHz), which increases sensitivity to physical layer impairments (PLIs). For example, the bit-error rate (BER) of a channel is sensitive to impairments such as optical signal-to-noise ratio (OSNR), chromatic dispersion (CD), and polarization mode dispersion (PMD) on all traversed links [2].

Typical network control and management planes of today's optical networks assign network resources based on static data and adhere to established specifications. However, many PLIs are time varying as a result of temperature variations, component degradations, and network maintenance activities [3]. Furthermore, dynamic channel bandwidth allocation and release processes can potentially change network conditions. A network capable of customizing the instantiation of new adaptive connections (flexpaths) to account for expected PLIs, and adapt as necessary to time varying PLIs, improves efficiency while optimizing individual connections for changes in network conditions [4]. Quality of transmission (QoT) monitoring and impairment aware routing and wavelength assignment (IA-RWA) algorithms in traditional WDM networks have already attracted research interest [3,5–7]. However, researchers now are facing the challenge of adapting these concepts to flexible bandwidth networking scenarios with potentially large bandwidth channels.

Optical performance monitoring of flexible bandwidth networks coupled with an adaptive control plane can provide a means to improve performance against time varying PLIs through impairment aware networking. In other words, the joint optimization of the routing and spectrum assignment (RSA) by the path computing element (PCE) nodes in such networks should consider the factor of time-varying impairments. For example, by incorporating

impairment awareness using a simple and effective performance monitoring technique, flexible bandwidth networks can react to changes in the quality of transmission (QoT) of each channel [8]. This requires an adaptive control plane that receives input from nodes regarding each channel's QoT. If the QoT for a particular channel degrades below an acceptable threshold, the change in modulation format to a less spectrally efficient format would use more bandwidth, but has an increased resistance to the signal degradation.

This manuscript presents flexible bandwidth experimental testbed demonstrations using an adaptive control plane that adjusts flexpath modulation format in an effort to maintain data rate under conditions of varying link OSNR. This ensures minimization of the spectral efficiency for each flexpath while maintaining an acceptable BER. In particular, Section 2 describes how impairment awareness in flexible bandwidth networks can be used to maintain the data-rate of potentially very large bandwidth flexpaths. Section 3 shows experimental results for a back-to-back test of impairment awareness using an adaptive control plane to maintain the data rate of a 360 Gb/s flexpath. Adjustments to the flexpath modulation format between eight phase-shift keying (8PSK), quaternary phase-shift keying (QPSK), and binary phase-shift keying (BPSK) ensure that a minimum of spectral usage and extend the range of acceptable OSNR values for successful transmission. Section 4 extends the experimental demonstration to two flexpaths (220 Gb/s and 120 Gb/s) that are simultaneously generated, precompensated for chromatic dispersion, and routed to different destinations. As one flexpath experiences a time varying OSNR, the adaptive control plane adjusts its modulation format between QPSK and BPSK, while spectrally shifting the other flexpath to maintain a defragmented spectrum. Finally, Section 5 concludes the paper.

## 2. Impairment awareness in flexible bandwidth networks

Flexible bandwidth networks with impairment awareness can potentially minimize the use of network resources (e.g., total spectral bandwidth) while meeting QoS requirements under dynamically changing traffic and physical layer impairment conditions. Here, flexible bandwidth networks leverage transmission systems capable of operating with very large bandwidth flexpaths to dynamically adjust the spectral utilization of individual flexpaths. This allows the preservation of a constant flexpath data rate under conditions of varying link impairments by adjusting the flexpath modulation format (i.e., spectral utilization). In this fashion, the spectral efficiency is lowered in situations of increased link impairment (or increased QoS requirement) or increased in situations of decreased link impairments (or decreased QoS requirement) in order to minimize the spectral resource utilized. This is in contrast to conventional WDM networks that are limited to a fixed bandwidth per channel due to the ITU grid spacing (G.649.1), which requires a change in data rate for conditions of varying link impairments. However, successful implementation of wide-scale impairment awareness in flexible bandwidth networks requires improvements to RWA used in conventional impairment-aware networks.

### 2.1 Flexible bandwidth networking with an adaptive control plane

The key to implementing impairment awareness in flexible bandwidth networks is the use of an adaptive control plane that is distributed yet centralized and can react to dynamic network situations such as varying flexpath QoT. Successful implementation of an adaptive control plane requires bidirectional communication between the control plane and each node. This allows the control plane to inform the nodes (network elements) of the spectral allocation used in the flexpaths and for the nodes to provide information to the control plane regarding the QoT of each flexpath. Figure 1(a) shows an example four-node network with two instantiated flexpaths. Here, an impairment on link 2, shown as an OSNR impairment, causes variations in the QoT of flexpath A.

Figure 1(b) shows three configurations for implementing the 360-Gb/s flexpath A in a scenario with 360 GHz of available bandwidth. In an ideal situation, flexpath A is

implemented using 8PSK (state **A**), which ensures the highest spectral efficiency and lowest spectral utilization. In this example, the control plane monitors the OSNR on flexpath **A** with feedback from Nodes 2 and 3. If the BER of flexpath **A** degrades above the predetermined bit-error rate (BER) threshold, the control plane reconfigures the flexpath modulation format. Here, QPSK (state **B**) and BPSK (state **C**) are alternative modulation formats that less spectrally efficient, but more resistant to OSNR impairments. In principle, this technique can be extended to other higher order single- or multi-carrier modulation formats.

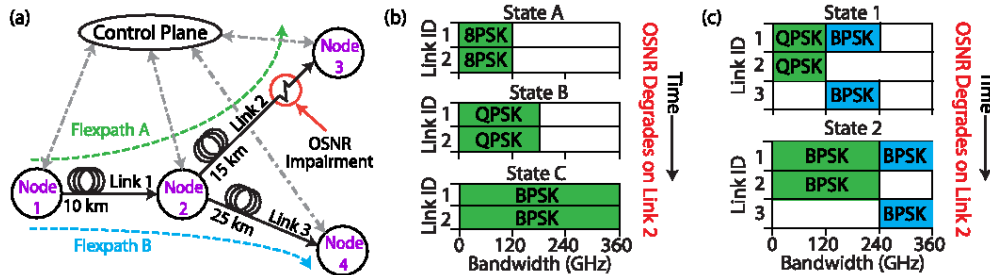

Fig. 1. (a) Flexible bandwidth networking scenario including time-varying OSNR on Link 2. Possible control plane adaptations to OSNR variations on link 2 include: (b) a single flexpath scenario in which flexpath (**A**) changes between 8PSK, QPSK, and BPSK to minimize spectral usage, or (c) a two flexpath scenario in which flexpath (**A**) changes between QPSK and BPSK to minimize spectral usage while flexpath (**B**) is spectrally shifted to maintain a defragmented spectrum.

In most networking situations, multiple flexpaths will be present simultaneously. Figure 1(c) shows possible state configurations for a two-flexpath scenario. In this example, flexpath **A** experiences a time varying OSNR degradation and changes between BPSK and QPSK, depending on its QoT. In order to accommodate this change, the spectral location of flexpath **B** is adjusted to maintain a defragmented spectrum. To this extent, the adaptive control plane can adjust both the modulation format and spectral location of each of the flexpaths individually.

In order to react to changes in QoT of each flexpath, the control plane needs an efficient means of monitoring the potentially broadband flexpaths. One method involves using a low speed supervisory channel to monitor the high speed flexpaths, which enables the control plane to cheaply and efficiently react to network changes. In this way, the adaptive control plane maintains flexpath data rate by increasing or decreasing the flexpath spectral efficiency under conditions of decreasing or increasing QoT, respectively.

Figure 2(a) details the flexible bandwidth wavelength cross connect (FB-WXC) node architecture. At each input to the node is a QoT monitor followed by an  $N \times N$  WSS to route

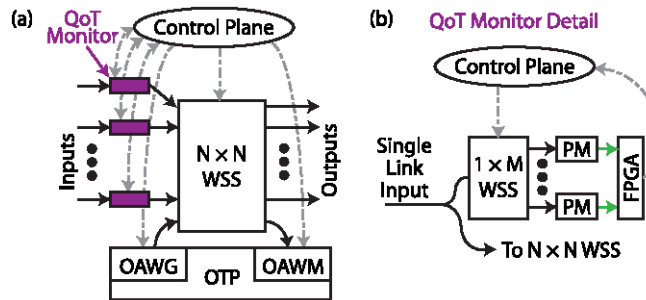

Fig. 2. (a) Flexible bandwidth wavelength cross connect (WXC) node detail. (b) Quality of transmission (QoT) monitor detail. WSS: wavelength-selective switch. OAWG: optical arbitrary waveform generation. OAWM: optical arbitrary waveform measurement. OTP: optical transponder. PM: performance monitoring. FPGA: field programmable gate array.

each flexpath to the desired output. The control plane configures the QoT monitors, WSS and OTP according to the current spectrum allocation map. Information sent from the QoT monitors to the control plane provides updates of the QoT of each flexpath allowing updates to the spectrum allocation map, if necessary. Figure 2(b) shows detail of a possible implementation of a QoT monitor based on a  $1 \times M$  wavelength selective switch (WSS), performance monitors and a field-programmable gate array (FPGA). By detecting a low speed supervisory channel on up to  $M$  flexpaths on an incoming link, the QoT monitor provides QoT information of high speed flexpaths through known correlation data.

An effective means of implementing the optical transponder (OTP) necessary for add/drop operations in each node (Fig. 2(a)) is to use dynamic optical arbitrary waveform generation (OAWG) and measurement (OAWM) [9–11]. This is a bandwidth scalable technique capable of generating the variable bandwidth and arbitrary modulation format flexpaths necessary for flexible bandwidth transmissions. Dynamic OAWG and OAWM operates over broad bandwidth by relying on the parallel processing of many lower bandwidth spectral slices that are manageable with currently available electronics. This technique allows the generation of both single- and multi-carrier flexpaths over its operation bandwidth. In comparison, other techniques are restricted to only using many low speed orthogonal subcarriers to generate broadband flexpaths [12].

### *2.2 RWA considerations for implementing impairment aware flexible bandwidth networks*

Effective IA-RWA requires accounting for transmission impairments during path computation. Previous work has shown the feasibility of implementing IA-RWA using path computation elements (PCEs) [13]. Moreover, the Internet Engineering Task Force (IETF) has defined two main IA-RWA PCE architectures for wavelength switched optical networks (WSOs) [14]: impairment validation and RWA (IV&RWA), and IV-candidate + RWA. However, there is a lack of implementation detail provided on the required specific PCE protocol (PCEP) extensions, which rely on a centralized control plane without any distribution of signaling and control. A properly designed combination of distributed and central control planes in a network can potentially support optimal network functionality through timely and well-coordinated control of the network. This architecture is similar to the human nervous system in which the reflex (i.e., the local control at the nodes) and the brain (i.e., the network control and management system (NC&M)) cooperate to support a rapidly responsive, yet well-coordinated, adaptive network. Such a control plane combines both centralized and distributed signaling by employing the centralized data control network (DCN) between the network elements forming the communication for NC&M and the distributed in-band signaling embedded in the datagram to provide local and rapid control decisions. The distributed control system can then provide statistical summary of the in-band signaling information to the NC&M, and the NC&M can see the ‘big picture’ based on the summary collected from various parts of the network to instruct distributed control system to take an action. In addition, the IA-RWA PCE architecture needs improvement to consider the inherently new capabilities of flexible bandwidth optical networks to enable assignment of arbitrary bandwidth channels with arbitrary modulation formats. Bringing impairment awareness to flexible bandwidth networking also raises similar challenges. In this case, extension of the IA-RWA algorithms to include impairment aware routing and spectrum allocation (IA-RSA) will enable the implementation of variable bandwidth flexpaths.

### **3. Single flexpath impairment awareness**

An adaptive control plane with impairment awareness has the ability to adjust flexpath modulation format to maintain data rate under conditions of time varying link impairments. This section presents a proof-of-principle experimental demonstration of impairment awareness for a single flexpath. In this back-to-back test, the adaptive control plane ensures successful transmission of a 360-Gb/s flexpath despite a time varying OSNR. Adjusting the

modulation format between 8PSK, QPSK, and BPSK (Fig. 1(b)) ensures constant data rate of the flexpath. This section considers only flexpath **A** from Fig. 1(a).

### 3.1 Experimental arrangement

Figure 3 depicts the experimental arrangement that emulates parts of Fig. 1(a) for the single flexpath impairment aware experiment. In this example, the transmitter in node **1** relied on static OAWG (i.e., line-by-line pulse shaping) [15] to produce broadband (i.e., up to 360 GHz) waveforms (e.g., 8PSK, QPSK, and BPSK) that repeat at the inverse of the optical frequency comb (OFC) spacing. Specifically in Fig. 3(a), a 10 GHz, 36-line OFC was generated through a combination of amplitude and phase modulation of a cw laser using a dual-electrode Mach-Zehnder modulator [16] followed by highly nonlinear fiber to further broaden the spectrum through self-phase modulation. Next, a 100-channel  $\times$  10-GHz spacing silica OAWG device individually modulated the amplitude and phase of each OFC line in order to generate the desired output waveforms. The amplitude and phase for each modulation format was stored in a lookup table and used to dynamically switch between modulation formats. A Mach-Zehnder modulator generated the supervisory channel by applying relatively a small overmodulation (17%) to the generated waveform. The supervisory channel consisted of a  $2^{31}-1$  pseudo-random bit sequence (PRBS) sequence from the Rocket I/O of a Virtex 5 FPGA, and resulted in a negligible impact on the high speed signal (see Fig. 4(a)).

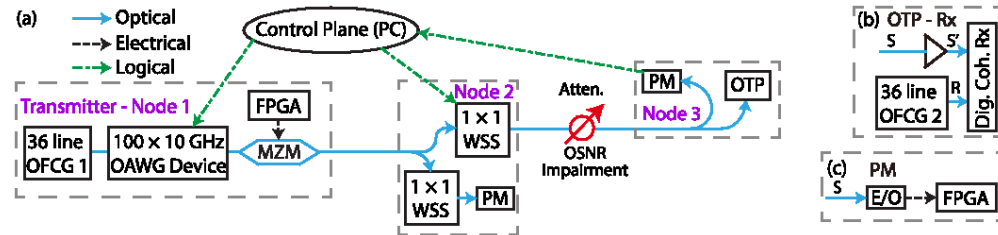

Fig. 3. (a) Experimental arrangement. Detail of (b) the receiver and (c) the performance monitor (PM). OFCG: optical frequency comb generator. OAWG: optical arbitrary waveform generation. MZM: Mach-Zehnder modulator. LEAF: low effective area fiber. WSS: wavelength selective switch. FPGA: field programmable gate array. OTP: optical transponder.

Node **2** consisted of a WSS that served to filter and route the flexpath to node **3**. Also shown is the potential to perform performance monitoring of the supervisory channel at node **2** using a second WSS and performance monitoring (PM) blocks. The OSNR impairment consisted of a variable attenuator situated between nodes **2** and **3**. At node **3**, constant monitoring of the supervisory channel BER using a 1 GHz photodiode and an FPGA (Fig. 3(c)) informed the PC based control plane of the supervisory channel BER.

For the proof-of-principle demonstrations in this paper, all flexpaths were generated with static OAWG, in which the modulations on each comb line were constant. This produced output waveforms that repeated at the inverse of the OFC spacing. At node **3**, these high 360 Gb/s flexpaths measurements using linear optical sampling [17] provided full-field (i.e., amplitude and phase) samples of the high speed waveform (Fig. 3(b)). The reference signal used for sampling was a second OFCG with 36 comb lines at a 10.01 GHz spacing generated from amplitude and phase modulation of a cw laser followed by additional phase modulations to increase the number of lines. Performing Q-factor based BER estimation on constellation diagrams generated from the linear optical sampling traces yielded the flexpath BER. This provided a good metric for signal integrity despite the use of repetitive waveforms [17].

### 3.2 Initial tests

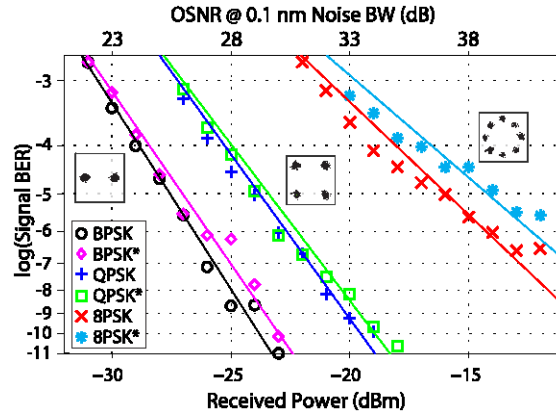

Fig. 4. State (A), state (B), and state (C) BER curves for the 360 Gb/s flexpath taken back-to-back with (\*) and without the supervisory channel. Insets show constellation diagrams taken at an OSNR of 40 dB @ 0.1 nm noise bandwidth. State (A) (8PSK)

Figure 4 shows BER results for the generation of the 8PSK, QPSK, and BPSK waveforms with and without the supervisory channel. The BER curves show a < 1 dB penalty from the inclusion of the supervisory channel. The 3-dB penalty between the 360 Gb/s BPSK and QPSK waveforms agrees with expected results. The 5–6-dB penalty between the 360 Gb/s QPSK and 8PSK is slightly larger than the expected 5 dB due to slight errors in waveform shaping.

### 3.3 Dynamic OSNR test

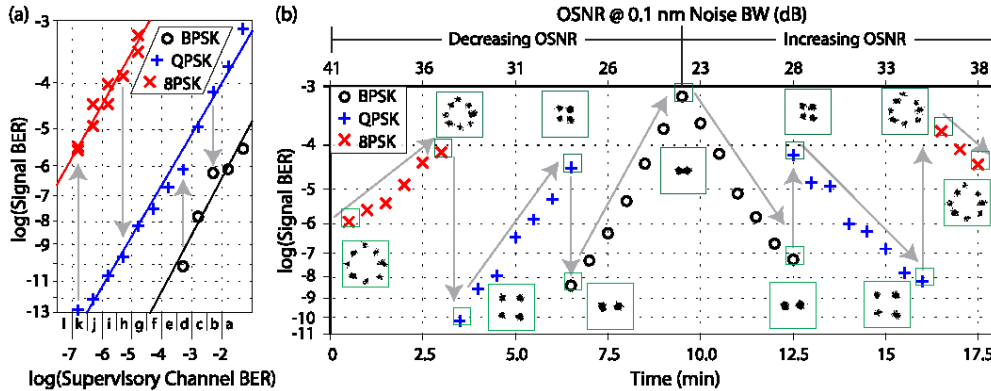

Fig. 5. (a) Correlation between BPSK, QPSK, and 8PSK BER of the flexpath and supervisory channel BER. Gray arrows indicate transition points between modulation formats and letters indicate supervisory channel BER regions. (b) Signal BER over time with time varying OSNR. Color changes for the flexpath indicate changes in modulation format state. Gray arrows indicate path of BER change of the signal over time. Inset constellation diagrams correspond to flexpath (A) BER points outlined in green.

In order to implement the adaptive control plane, it was necessary to correlate the 1.25 Gb/s supervisory channel BER to the 360 Gb/s flexpath BER. Figure 5(a) shows the measured correlation between the supervisory channel and flexpath in 8PSK, QPSK, and BPSK modulation formats. Transition points between modulation formats for the adaptive control plane to use were chosen (gray arrows) in order to ensure successful transmission below the FEC BER limit of  $10^{-3}$  for Reed-Solomon (255,239) code. Additionally, an offset between adjacent modulation format transition points helped to avoid situations of rapid switching.



Figure 5(b) shows the results of adaptive reconfiguration of the 360 Gb/s flexpath under conditions of a time varying OSNR variation at the rate of 1 dB every 30 seconds. The adaptive control plane decided the flexpath modulation format according to Fig. 5(a). Each modulation format transition took ~100 ms, limited by the use of thermo-optic modulators in the OAWG device. In left half of Fig. 5(b), the increasing link OSNR impairment caused the flexpath to change from 8PSK to QPSK to BPSK. The changes in modulation format resulted in a 12 dB reduction in sensitivity of the flexpath to an OSNR degradation. The right half of Fig. 5(b) shows the flexpath increasing in spectral efficiency with decreases in the link OSNR impairment.

#### 4. Demonstration of two flexpath impairment awareness

This section presents an experimental demonstration of impairment awareness with two flexpaths. Following the node diagram from Fig. 1(a), and possible flexpath states from Fig. 1(c), this scenario involves 220 Gb/s flexpath **A** and 120 Gb/s flexpath **B**. In this particular example, flexpath **A** undergoes a time varying OSNR on link 2. Here, due to the combination of both local control planes (LCPs) and a centralized NC&M, impairment-aware adjustments of network utilization involve two steps. Firstly, the LCP at Node 3 (i.e., the reflex system) detects the presence of an impairment (e.g., time varying OSNR) and informs the NC&M (i.e., the brain). At this point the NC&M decides the needed changes to the spectral utilization of the affected flexpaths and informs the LCPs to adjust flexpath generation and routing accordingly. Additionally, the NC&M determines if spectral defragmentation is necessary.

##### 4.1 Experimental arrangement

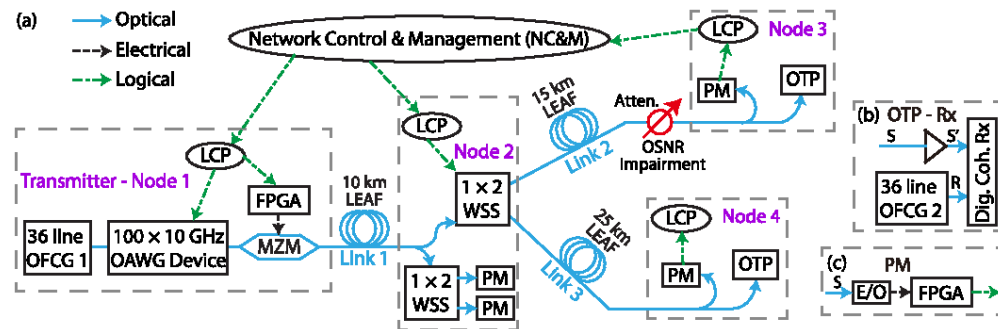

Fig. 6. (a) Experimental arrangement. Detail of (b) the receiver and (c) the performance monitor (PM). OFCG: optical frequency comb generator. OAWG: optical arbitrary waveform generation. MZM: Mach-Zehnder modulator. LEAF: low effective area fiber. LCP: local control plane. WSS: wavelength selective switch. FPGA: field programmable gate array. OTP: optical transponder.

Figure 6 shows the experimental arrangement used for the two flexpath experiment that includes the key elements of Fig. 1(a). This experiment builds on the back-to-back experimental arrangement from Fig. 3 by including low effective area fiber (LEAF) between the nodes. Here, the NC&M together with the LCPs at each node functioned to implement the adaptive control plane. Additionally, the waveforms generated by the OAWG device included precompensation for the chromatic dispersion incurred on each flexpaths from the addition of the LEAF fiber. Due to the different lengths of fiber traveled by the two flexpaths, the OAWG transmitter applied different amounts of chromatic dispersion precompensation to each one. Also, a supervisory channel implemented using an only 11% overmodulation ensured minimal penalty.

#### 4.2 Initial tests

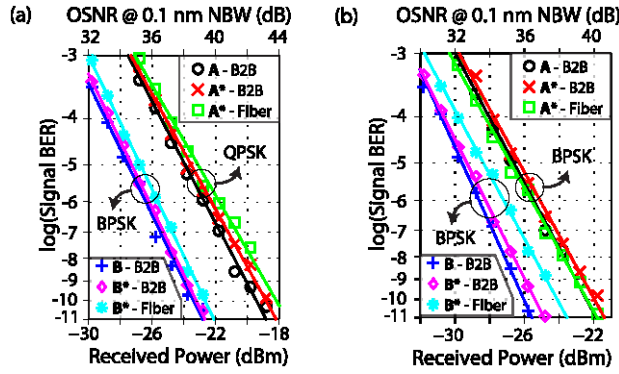

Fig. 7. State 1 (a) and state 2 (b) BER curves for 220 Gb/s flexpath (A) and 120 Gb/s flexpath (B) taken back-to-back with (\*) and without the supervisory channel, and with fiber.

Figure 7(a) shows the back-to-back (i.e., no fiber) BER results for flexpaths A and B with and without the supervisory channel, and with fiber for state 1. Figure 7(a) shows the same results for state 2. For both states, there is a < 1-dB penalty for inclusion of the supervisory channel. For state 1, there is a 4-dB penalty between the BER curves for the 220 Gb/s QPSK (flexpath A) and 120 Gb/s BPSK (flexpath B), which is due to the more stringent OSNR requirements for QPSK. In state 2, the power penalty of 3-dB between the 220 Gb/s BPSK (flexpath A) and 120 Gb/s BPSK (flexpath B) signals comes from output power sharing of an EDFA (not shown) in link 1.

#### 4.3 Dynamic OSNR test

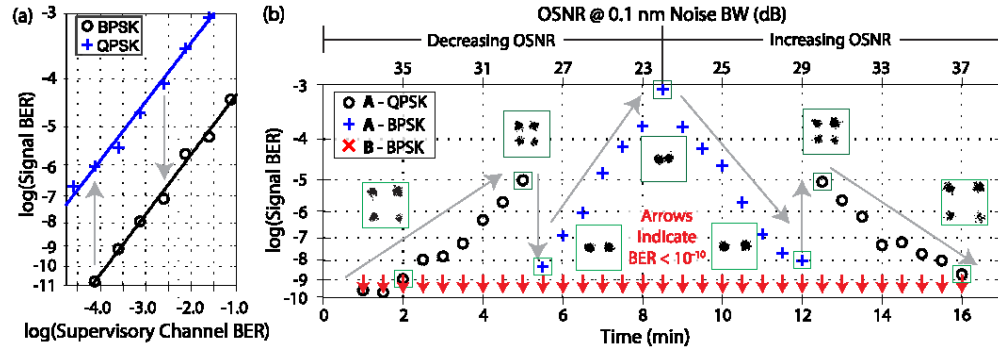

Fig. 8. (a) Correlation between BPSK and QPSK BER of flexpath (A) and supervisory channel BER. Gray arrows indicate transition points between modulation formats. (b) Signal BER over time with time varying OSNR. Color changes for flexpath (A) indicate changes in modulation format. Gray arrows indicate path of BER change of the signal over time. Inset constellation diagrams correspond to flexpath (A) BER points outlined in green.

Figure 8(a) shows correlation data between the supervisory channel BER and flexpath A's BER. The transition points between modulation formats (indicated by gray arrows) are offset to avoid rapid transitions back and forth between the two states. Figure 8(b) shows the BER and modulation format of flexpaths A and B as the OSNR on link 2 undergoes a time varying change. Here, the FPGA analyzed the supervisory channel BER and provided updates to the adaptive control plane, which implemented spectral allocation adjustments as necessary according to Fig. 8(a). The FPGA provided updates to the control plane at a range of rates from 12.5 kHz for a BER of  $1 \times 10^{-3}$  and 0.125 Hz for a BER of  $1 \times 10^{-9}$ . Changes to flexpath A OSNR were made at a rate of 1 dB every 30 seconds by manual adjustment of the

attenuator before the preamplified receiver. The left half of Fig. 8(b) shows that as the OSNR of flexpath **A** decreases, its modulation format changed from QPSK to BPSK. The right half of Fig. 8(b) shows that as the OSNR of flexpath **A** is increased, its modulation format changed from BPSK to QPSK, while flexpath **B** is again spectrally shifted. The modulation format adjustments to flexpath **A** extends the range of OSNR over which its BER is below the FEC limit of  $10^{-3}$ . Meanwhile, the BER of flexpath **B** remains error free despite having been spectrally shifted.

## 5. Conclusions

Flexible bandwidth networking provides a means for scaling network infrastructure through more efficient spectrum allocation and offers the potential for agile networking. Additionally, flexible bandwidth systems based on bandwidth scalable technologies such as OAWG/OAWM are capable of generating arbitrary bandwidth flexpaths, in which each flexpath can be in a different modulation format. This enables implementing impairment awareness for maintaining the data rate of flexpaths by adjusting their spectral utilization (i.e., modulation format) in conditions of varying link impairments (e.g., OSNR). In this manuscript, we presented flexible bandwidth network testbed demonstrations of impairment awareness that rely on a commercial FPGA and a 1.25 Gb/s supervisory channel to provide monitoring information for 360 Gb/s and 220 Gb/s flexpaths. First, a single 360 Gb/s flexpath was changed between 8PSK, QPSK, and BPSK to ensure minimum spectral usage for a successful back-to-back test under conditions of a time varying OSNR. The modulation format changes extend the range of OSNR over which the flexpath BER is below the FEC limit of  $10^{-3}$  by 12 dB. Second, the simultaneous generation of two flexpaths (220 Gb/s and 120 Gb/s) by a single OAWG transmitter, enabled applying appropriate amounts of chromatic dispersion precompensation to each flexpath. In this case, one flexpath was changed between QPSK and BPSK as its OSNR was varied, while the other flexpath was spectrally shifted to maintain a defragmented spectrum. These proof-of-principle experimental demonstrations show that an adaptive control plane can successfully update the spectral allocation for large bandwidth flexpaths based on monitoring information from low speed supervisory channels. Future flexible bandwidth networks implemented with adaptive impairment-aware control planes are envisioned to improve efficiency while maintaining a desired QoS using relatively simple performance monitoring.

## Acknowledgments

This work was supported in part by DARPA and SPAWAR under OAWG contract HR0011-05-C-0155, under NSF ECCS grant 1028729, and under the CISCO University Research Program. The authors thank Nistica for the loan of the WSS units.