

Interference of Periodic and Spread-Spectrum-Modulated Waveforms with Analog and Digital Communications

Original

Interference of Periodic and Spread-Spectrum-Modulated Waveforms with Analog and Digital Communications / Crovetto, Paolo S.; Musolino, Francesco. - In: IEEE ELECTROMAGNETIC COMPATIBILITY MAGAZINE. - ISSN 2162-2264. - STAMPA. - 11:2(2022), pp. 73-83. [10.1109/MEMC.2022.9873819]

Availability:

This version is available at: 11583/2971978 since: 2022-10-02T17:12:06Z

Publisher:

IEEE

Published

DOI:10.1109/MEMC.2022.9873819

Terms of use:

This article is made available under terms and conditions as specified in the corresponding bibliographic description in the repository

Publisher copyright

IEEE postprint/Author's Accepted Manuscript

©2022 IEEE. Personal use of this material is permitted. Permission from IEEE must be obtained for all other uses, in any current or future media, including reprinting/republishing this material for advertising or promotional purposes, creating new collecting works, for resale or lists, or reuse of any copyrighted component of this work in other works.

(Article begins on next page)

Interference of Periodic and Spread-Spectrum-Modulated Waveforms with Analog and Digital Communications

Paolo S. Crovetto, Francesco Musolino
Department of Electronics and Telecommunications (DET),
Politecnico di Torino (Italy)

Email: {paolo.crovetto, francesco.musolino}@polito.it

Abstract— In this article, the effectiveness and the limitations of spread-spectrum (SS) modulation techniques employed in switching-mode power converters and in digital systems to mitigate interference with communication equipment are analyzed and discussed under the EMC standard perspective and under an information theoretical perspective, with reference to different real-world scenarios. Substantial difference between potential EMI issues in traditional analog radio/TV broadcasting, digital data lines, and digital links featuring advanced channel coding techniques, e.g. in emerging power line communication (PLC) systems, are highlighted. Practical recommendations on the adoption of SS modulations along with a general reflection on the evolution of EMC requirements are finally given.

Index Terms— Electromagnetic Interference (EMI), Spread-Spectrum (SS) modulations, Digital communications, Analog communications, Power-line communications

I. Introduction

The potential interference of electric and electronic equipment with communication systems has been one of the main EMC concerns, starting from the earliest studies [1], which deals on radiocommunications in general, and [2], which deals with car receivers. While the goal – i.e., avoiding interference – is always the same through the years, the players, i.e. the sources of interference and the potential victims, are continuously changing. This gives rise to new scenarios and EMC challenges, so that EMC requirements and electromagnetic interference (EMI) mitigation techniques cannot be regarded as fixed and/or universal, but need to be considered in a continuously evolving perspective. In this framework, the interference between aggressors whose operation is based on periodic switching waveforms, like switching-mode power converters [3] and digital equipment [4], and communication equipment, like radio/TV sets, wired and wireless data channels and emerging power line communication (PLC) systems is discussed in this article. In particular, the effectiveness and the limitations of spread spectrum (SS) modulation techniques [5] employed starting from the 1990s in power converters [6] and in digital circuits [7] to comply with EMC requirements are addressed. To gain a better understanding, the proposed analysis is carried out under two different perspectives, i.e. the

EMC regulations perspective [8]-[13] and the information theory perspective [14]-[17], which provides a rigorous mathematical framework to discuss the effect of noise on the amount of information that can be reliably transferred over a communication channel. The insight gained by this analysis is then exploited to describe practical application scenarios in which SS modulations are employed and to give some suggestions concerning the adoption of SS modulations in real world applications.

In the rest of the article, the EMC regulation perspective is first presented and historically contextualized in Section II. In section III, the SS modulations are introduced as a mean to reduce the EMI level when measured according to EMC standards, and an overview of different SS modulations is proposed. In section IV, the information theoretical perspective is introduced and it is shown how the effects of EMI on communication channels can be described in the framework of Shannon information theory in terms of an equivalent, EMI-induced channel capacity loss. Within this framework, the effectiveness of SS modulations in different application scenarios is compared and several practical recommendations on SS modulations are given in Section V. Some concluding remarks are finally drawn in Section VI.

II. Development of EMC Regulations

Since the very beginning of the electrical communications era, the electromagnetic spectrum has been exploited to transmit a number of different signals at the same time, often resulting in interference between communication and non-communication systems [1]. Analog AM radio and TV receivers adopted in early times, in particular, were extremely susceptible to interference generated by other electrical equipment.

Improvements in the radio receivers design, adopted on a case-by-case basis, were initially sufficient to successfully address such interference issues. As the electromagnetic spectrum became more and more crowded, due to the proliferation of radio stations, some regulatory committees have been established in different countries to manage the spectrum allocation and to define methods of measurement and specification of maximum allowable EMC limits [18].

Electromagnetic interference gained formal acceptance in 1933 when the International Electrotechnical Commission (IEC) and the Union Internationale de Radiotéléphonie (UIR, International

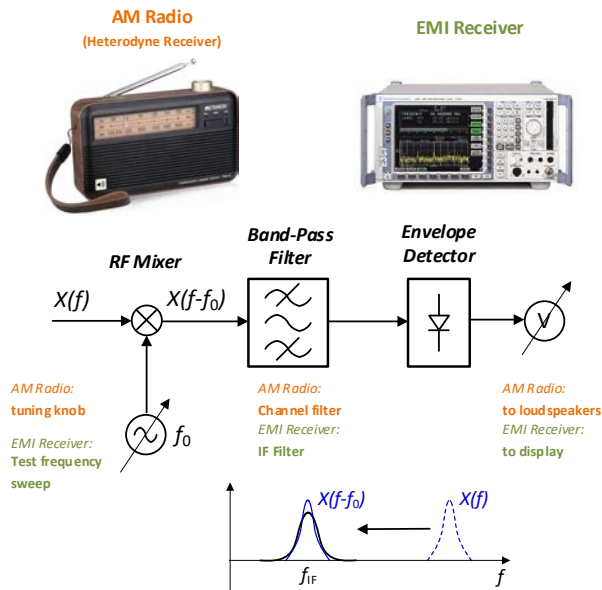

Fig. 1– When most EMC standard and regulations have been conceived, preserving very sensitive analog radio and TV broadcasting from interference was the primary EMC goal. For this reason, the specifications of EMI receivers for EMC assessment closely resemble those of a traditional heterodyne analog radio receiver. The same EMC standards are still in force.

Sound Broadcasting Union), in the attempt to establish international uniformity in such regulations, agreed to form a joint committee, the International Special Committee on Radio Interference (CISPR), to discuss, harmonize and distribute specific requirements so that to avoid international trade problems [19]. These requirements, specified during the first meeting of the CISPR that was held in Paris in 1934, consisted of recommended allowable emissions and immunity limits for electronic systems and specific measurement techniques to verify these limits to guarantee an acceptable audio and video quality in radio and TV broadcasting. Such early EMC problems, for these reasons, were referred to as Radio Frequency Interference (RFI) issues. Test RFI receivers, showing characteristics similar to that of today quasi-peak receivers with a 9 kHz detector bandwidth, were designed at that time to verify the compliance of electric equipment with the RFI requirements. In 1934 the Federal Communications Commission (FCC) was established as an independent agency of the U.S. government to issue regulations and recommendations in order to limit interference between radio station transmitters that were too closely located. EMC problems intensified during the World War II due to the widespread of new radio transmitters and receivers for vehicular radio communications, radio detection and ranging (RADAR) for localization, and intentional EMI generation to impair enemy communications. Experiences during this period convinced major military agencies to define more stringent interference specifications which, eventually, were standardized in 1968 [8]. With the rapid development of high-speed, low-power, low-cost semiconductor devices and microprocessors in the 1970s-1980s,

more and more electronic systems that behave simultaneously as sources and receptors of EMC issues started to be installed in domestic and office environments. In particular, due to these technological advances, the term RFI was progressively replaced in these years by the more general definition of EMI. In 1979, FCC updated its EMC standards to cope with the interference of digital electronics, and in 1989 the European Union issued a directive [9] with the aim of controlling electromagnetic emissions from apparatuses, medical equipment and a large variety of electronic devices that were not included in the FCC requirements. Moreover, the European Union directive also established requirements for the electromagnetic immunity of these devices and defined procedures for testing the susceptibility of electronic systems to electromagnetic fields [9].

a) Analog AM Radio

To understand better the spirit of EMC standards and regulation requirements, which date back to the early times and are still in force, it is useful to consider the structure of a classical heterodyne AM analog radio receiver, as depicted in Fig.1. The RF signal is picked up by the antenna and then multiplied by a locally generated sine wave at a tunable frequency f_0 . This multiplication has the effect to translate the spectrum of the received signal in the frequency domain, so that to bring the channel of interest within the bandwidth of a fixed band-pass filter at intermediate frequency (IF), the channel filter. The output of the channel filter is finally demodulated by an envelope detector, whose output is amplified and drives the loudspeakers of the radio or a CRT in the television set.

b) EMI Receiver and Regulations

Since the main EMC problem was historically related to analog radio and TV, EMI is actually measured with an equipment - the EMI receiver shown in Fig.1 – whose operation closely resembles an analog radio. The local oscillator frequency is swept to “tune” the receiver in a frequency range defined by the standards, the IF filter picks a portion of the spectrum corresponding to the bandwidth of a channel and the output of the filter is finally processed either by an average, peak, or quasi-peak detector, whose characteristics are defined in the same standards. The output voltage of the detector at each test frequency is acquired and plotted to get the EMI spectrum measured according to the standard. The CISPR 16 is a standard document that specifies the characteristics and performance of equipment for the measurement of interference in the frequency range 9 kHz to 18 GHz [10]. EMI receivers are designed to comply with these requirements for measurements performed according to CISPR (both for Industrial, scientific and medical equipment [11] and vehicles [12]) and FCC standard measurements [13]. Table I summarizes the characteristics of the IF bandwidth at the -6 dB points for peak detector EMI receivers as specified in CISPR 16 [10].

TABLE I CISPR 16 [10] IF BANDWIDTH REQUIREMENTS.

| Frequency Range | IF Bandwidth (6 dB) |
|------------------|---------------------|
| 9 kHz – 150 kHz | 200 Hz |
| 150 kHz – 30 MHz | 9 kHz |
| 30 MHz – 1 GHz | 120 kHz |
| 1 GHz – 18 GHz | 1 MHz |

TABLE II – MIL-STD 461 [8] IF BANDWIDTH REQUIREMENTS

| Frequency Range | IF Bandwidth (6 dB) |
|------------------|---------------------|
| 30 Hz – 1 kHz | 10 Hz |
| 1 kHz – 10 kHz | 100 Hz |
| 10 kHz – 150 kHz | 1 kHz |
| 150 kHz – 10 MHz | 10 kHz |
| 10 MHz – 30 MHz | 10 kHz |
| 30 MHz – 1 GHz | 100 kHz |
| Above 1 GHz | 1 MHz |

TABLE III – CISPR 25 [12] AND CISPR 11 [11] CONDUCTED EMISSION MEASUREMENTS: FREQUENCY STEP SIZE

| Frequency Range | CISPR 25 | CISPR 11 |
|------------------|----------|----------|
| 150 kHz – 30 MHz | 5 kHz | 4 kHz |
| 30 MHz – 108 MHz | 50 kHz | / |

output of the detector, and hence to the highest EMI level measured according to the standards. The measured EMI power immediately drops when the test frequency is slightly increased or decreased.

By contrast, for wideband EMI, even if the spectrum of disturbances is fully aligned with the IF filter central frequency, part of the EMI power falls outside of its bandwidth, and the measured EMI value is therefore lower. The same EMI value is however measured at several adjacent test frequencies, thus possibly affecting more channels.

Since the spectrum measured by the EMI receiver should be below a pass/fail threshold to comply with EMC standard requirements, narrowband EMI gives rise to a higher measured EMI level compared to wideband EMI with the same total power, and is therefore much more critical from the EMC standard perspective. Unfortunately, disturbances generated by switching-mode power converters and synchronous digital circuits are periodic signals and their spectrum is made up of very narrow spectral lines at the harmonics of the clock frequency. This makes it particularly challenging to meet standard EMC requirements for a wide class of industrial and consumer electronic equipment.

In view of that, one could wonder if it is possible to replace periodic square waves in power converters and digital circuits with other waveforms, whose spectral properties are more favorable in the EMC emissions standard perspective (i.e., with the same EMI power spread over a wider bandwidth). SS modulations [5] have been introduced in 1990s with this precise intent and are described in the next Section.

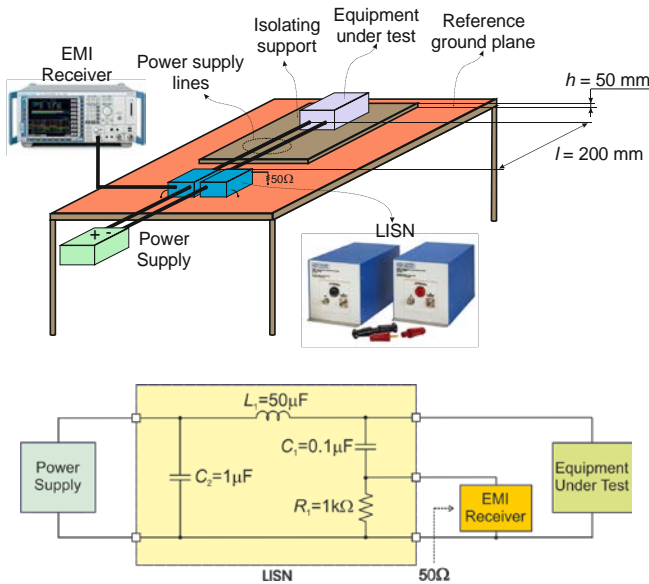

Fig.2 Electromagnetic emissions test setup including the EMI receiver and line impedance stabilization networks (LISN) and schematic diagram.

Table II lists the IF bandwidths as defined by the military standard MIL-STD 461 [8] which is the normative aiming to define limits and methods of testing of all electronic, electrical, and electromechanical equipment and subsystems designed to be employed in military activities.

Table III shows the measurement frequency step width for conducted emission tests defined by EMC standards such as the CISPR 25 [12], which is the EMC normative for electronic components intended for use in vehicles, the CISPR 11 [11] which applies to industrial, scientific and medical electrical equipment. Actually, the EMI receivers described above are used both in conducted and in radiated EMC tests. The typical test setup of a conducted emission test to measure the interference injected by the equipment under test is shown in Fig.2; it can be observed that the EMI receiver is connected to a line impedance stabilization network (LISN) which ensures a controlled RF termination impedance for the EUT input regardless the fluctuations of the power line impedance. With reference to such a setup, the spectrum measured by the EMI receiver at each test frequency should be below a pass/fail threshold – specified for each class of equipment under test - to comply with EMC regulations.

c) Narrowband and Wideband EMI

As shown in Fig.3, the operation of the EMI receiver in the presence of narrowband EMI, i.e. EMI whose bandwidth is narrower than the IF filter (in blue in Fig.3), and wideband EMI, i.e. EMI whose bandwidth is (significantly) wider than the IF filter (in red in Fig.3), with the same power, is very different. For narrowband EMI, indeed, in correspondence of a test frequency, the whole EMI power falls within the IF filter band, giving rise to the highest

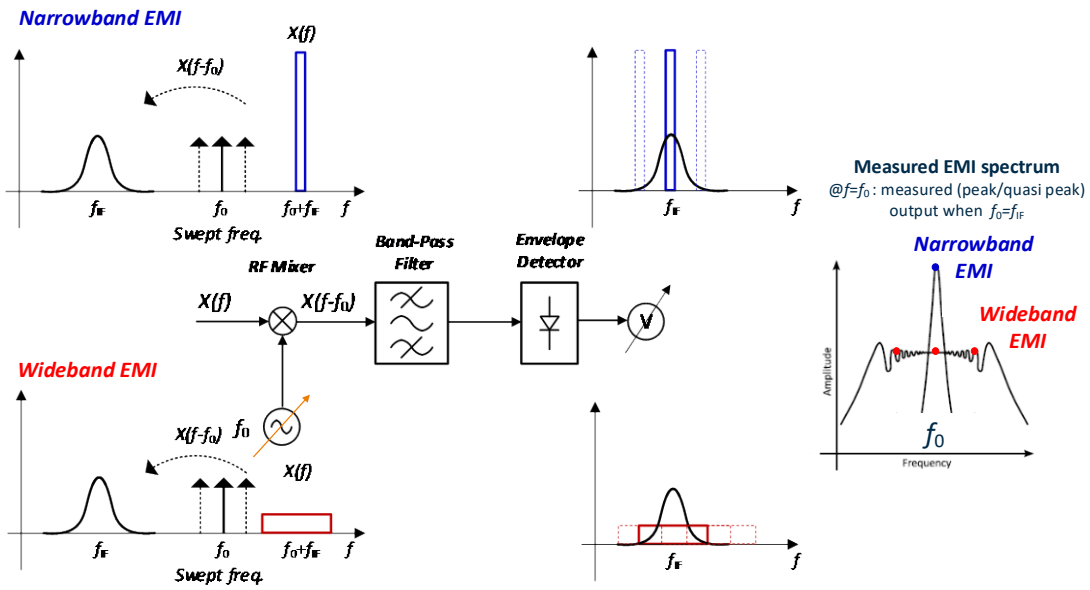

Fig. 3– Differences in EMI spectra measured with a standard EMI receiver as in Fig.1 for narrowband EMI (i.e. EMI with a bandwidth much smaller than the IF filter bandwidth) and wideband EMI (i.e. EMI with a bandwidth much larger than the IF filter bandwidth) under same total power. A significantly higher EMI peak is measured for narrowband EMI, which makes it more difficult to comply with the EMC standard regulations.

III. Spread-Spectrum (SS) Modulations

Spread-spectrum (SS) modulations consist in varying the instantaneous frequency \hat{f} of a periodic signal in time according to a deterministic or to a random profile $-1 < m(t) < 1$ around its nominal frequency f_0 [5], i.e.

$$\hat{f}(t) = f_0 \left[1 + \frac{\Delta f}{f_0} m(t) \right] = f_0 [1 + \delta \cdot m(t)] \quad (1)$$

where Δf is the absolute frequency deviation and $\delta = \Delta f / f_0$ is the relative frequency deviation, as illustrated in Fig.4.

If the instantaneous frequency variations are fast enough compared to the bandwidth of the IF filter and/or of the detector, the net effect of SS modulations is to spread the spectral power - originally concentrated at the frequency f_0 and its harmonics - over a bandwidth $k\Delta f$, being Δf the maximum frequency deviation and k the number of the harmonic under consideration. For this purpose, different frequency modulation profiles, i.e. sine wave, saw-tooth, linear, Hershey kiss, and random can be adopted, as illustrated in Fig.4.

From Fig.5, the effect of SS modulations on the EMI spectra measured according to the CISPR 25 standard [12] can be appreciated: a significant reduction of the spectral peak is always observed, resulting in an EMI spectrum peak reduction between 10 dB and 25 dB, which increases with the modulation depth (i.e. the max-min frequency deviation range). The flattest spectrum, and the largest peak reduction (over 25 dB) is obtained with random modulations. A similar spreading effect can be achieved also by varying other parameters of a switching waveform, like the pulse position or the duty-cycle, according to a deterministic or random pattern. All these approaches have been extensively

studied and compared in research works over the last two decades: among the others, a thorough comparison of the spectral characteristics of different SS modulations is offered in [20] and their impact on the power quality is analyzed in [21]. When SS modulations are applied to a power converter or to a digital system, several aspects need to be carefully considered. In particular, the frequency deviation cannot exceed 10%-20% not to impair the operation of the digital or power system [5]. Moreo-

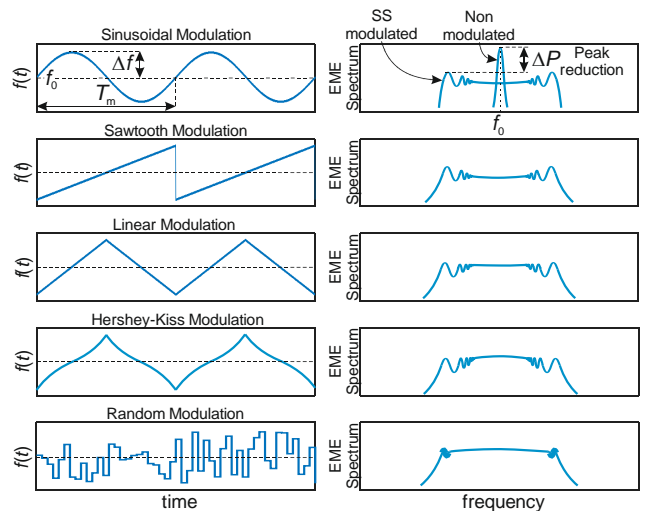

Fig. 4 Different modulation profiles adopted in spread-spectrum modulations (left column) and their impact on the EME spectrum peaks (right column). From the top to the bottom: sinusoidal modulation, sawtooth modulation, linear modulation, Hershey-Kiss modulation and random modulation.

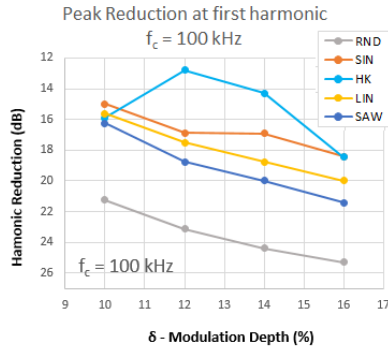
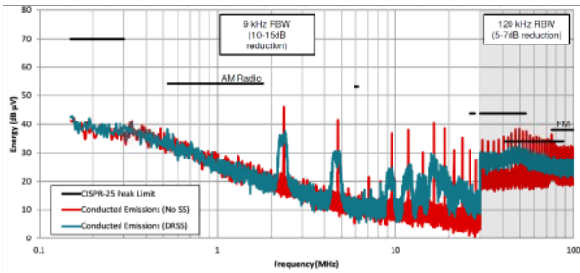

Fig.5 EMI spectra measured according to CISPR25 with and without SS modulation [12] (top) and peak reduction at the fundamental achieved by the different SS-modulation profiles introduced in Fig.4 [16].

ver, the modulating waveform should be fast enough, and an accurate model of the EMI receiver needs to be adopted to properly predict the effectiveness of SS, since spectrum estimates based on a simple FFT or other general-purpose spectral analysis techniques can easily lead to wrong results, as pointed out in [5] and other works.

In any case, a reduction of EMI peaks measured according to the standards ranging from 12 dB to more than 20 dB can be easily achieved by SS under practical conditions, which has motivated the widespread adoption of SS modulations in industrial and consumer applications (power converters [22], microcontrollers [23], clock oscillators [24]).

In spite of the unquestionable effectiveness of SS in reducing the EMI peaks measured according to EMC standards, one can wonder if they effectively help in reducing the interfering potential of switching waveforms with present day wireless and wired communication systems, which are generally different from the analog communication equipment in use at the time the EMC standards were conceived.

Answering this question is important for at least two reasons: first, to understand if and to what extent SS techniques can be adopted in practice to address real-world interference problems; second, to discuss if, and to what extent, the results of standard EMC tests give a faithful assessment of the potential degree of impairment brought by switching signals to present day communication systems.

This question, indeed, has been addressed in an increasing number of technical papers over the last years (references from [25] to [36]), leading to apparently contradicting conclusions, revealing either a worse interfering potential of SS disturbances, as in

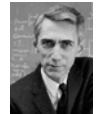
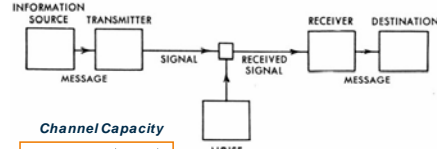

Claude Shannon, 1916-2001

Channel Capacity

$$C = B \log_2 \left(1 + \frac{S}{N} \right)$$

S data signal power
N total noise power
B channel bandwidth

- Channel capacity: maximum bit rate (bit/s) attainable for reliable communication @ bandwidth B and signal-to-noise ratio S/N.
- The effects of EMI can be described in terms of an equivalent reduction of the channel capacity

C. E. Shannon, "A mathematical theory of communication," in The Bell System Techn. Journ., vol. 27, no. 3, pp. 379-423, July 1948

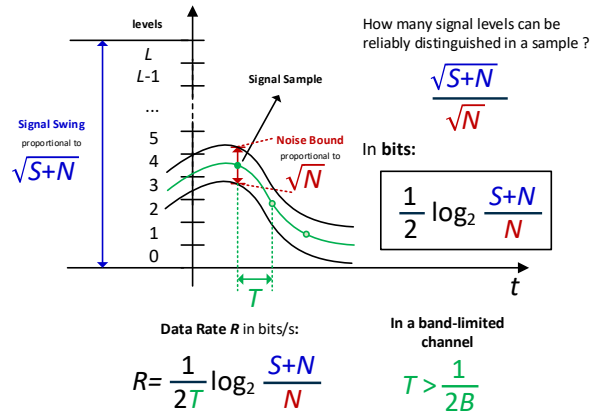

$$R < B \log_2 \left(1 + \frac{S}{N} \right)$$

CHANNEL CAPACITY C

Fig.6 Channel capacity concept and illustration

references from [25] to [31], or no remarkable effect (references from [32] to [35]) or also a reduced interfering potential of SS disturbances [36]. In order to investigate this important point, in [16] (for wideband EMI coupling) and [17] (for narrowband EMI coupling) we proposed to tackle the problem under an information theoretical perspective, which is illustrated in the next Section.

IV. The Information Theory Perspective

In recent years, we suggested that the interfering potential of SS can be rigorously discussed in the framework of Shannon's information theory [15], in terms of a channel capacity reduction [16]. This approach will be introduced and illustrated in the following.

a) Channel Capacity

The channel capacity has been introduced by Shannon in his seminal paper [14] with reference of a simple model of a band-limited communication channel (Fig.6, top), including an information source (transmitter) and a receiver and a noise source. With reference to such a model, Shannon showed that the maximum rate at which information can be reliably transferred from the source to the receiver, which is dubbed the *channel capacity*

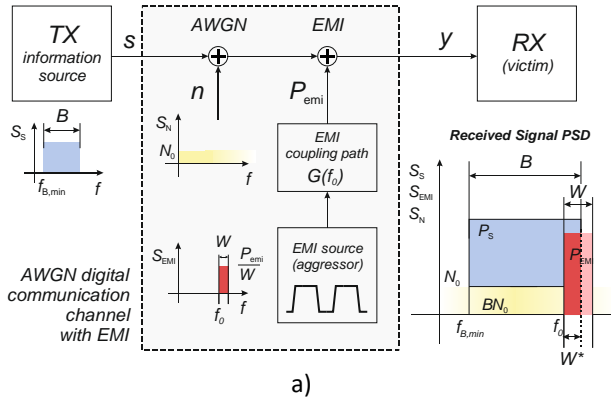

$$\frac{1}{2} \log_2 \left(\frac{S+N}{N} \right) \text{ bit/sample} \quad (3)$$

Supposing that one independent sample is transmitted every time interval T , the maximum amount of information which can be successfully transferred in the unit time, indicated as the *bit rate* R , can be obtained dividing by T the information which can be associated to a sample. By the sampling theorem, on a band-limited channel, the sample time is constrained to be larger than twice the reciprocal of the available bandwidth B . As a consequence, based on (3) it follows that

$$R < B \log_2 \left(1 + \frac{S}{N} \right) = C \quad (4)$$

i.e. the maximum successful transmission rate attainable over the channel is necessarily less than the channel capacity given by the Shannon equation (2).

b) EMI-Induced Capacity Loss

In the framework of information theory, the effect of SS and non-SS interference in a communication channel can be described in terms of an equivalent capacity loss. For this purpose, the channel model in Fig.7a can be considered. In this model, there is an information source, a background noise source (as in Shannon's model) and an additional noise source, which describes EMI generated by an aggressor that can be either periodic or SS-modulated in our analysis. With reference to such a model, the overall capacity C of the channel corrupted by EMI can be evaluated as the sum of the capacity C_1 of the EMI free sub-channel:

$$C_1 = \int_{B-B \cap W} \log_2 \left(1 + \frac{S_s}{S_N} \right) df, \quad (5)$$

where $S_s(f)$ and $S_N(f)$ are the nominal signal and the background noise power spectral densities, respectively; and of the capacity of the sub-channel affected by EMI, i.e.

$$C_2 = \int_{B \cap W} \log_2 \left(1 + \frac{S_s}{S_N + S_{EMI}} \right) df, \quad (6)$$

where $S_{EMI}(f)$ is the EMI power spectral density. In [16] we have applied this approach to a channel with a fixed bandwidth B and a signal-to-background noise ratio α of 40 dB, and we have evaluated the capacity of the channel in the presence of EMI under fixed total power P_{EMI} and for different values of the SS modulation spreading bandwidth W . The results of our analysis are reported in Fig. 7b. Under very narrow EMI bandwidth, the EMI induced capacity loss of the overall channel is almost negligible in spite of the very high EMI peak in correspondence of the EMI line. By contrast, keeping the EMI power constant, whenever the spreading bandwidth is increased, the EMI-induced capacity loss is more and more relevant, and becomes maximum when the EMI spreading bandwidth W coincides with the channel bandwidth B . This behavior, which is more and more significant at higher total

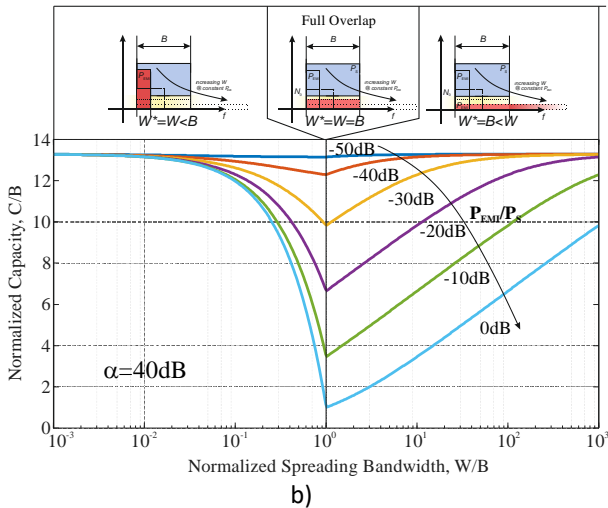

Fig.7 EMI-Induced Channel capacity loss: model of a communication channel affected by spread-spectrum EMI and EMI-induced capacity loss under constant EMI power uniformly spread over a bandwidth W (from [16])

C , is related to the signal-to-noise ratio S/N , i.e. the ratio of the signal power S to the noise power N , and to the bandwidth B of the channel, by the equation:

$$C = B \log_2 \left(1 + \frac{S}{N} \right). \quad (2)$$

To better understand this fundamental result, it can be observed that retrieving information from the received signal means to distinguish the transmitted level among a discrete set of other possible transmitted values, as illustrated in Fig.6. Whenever the noise amplitude is larger than an amplitude quantization interval, it is clear that this is no longer possible. As a consequence, it is reasonable to assume that the maximum number of levels which can be reliably identified needs to be less than the ratio of the signal amplitude (proportional to the square root of the total, i.e. signal and noise, received power, $\sqrt{S+N}$) to the noise-related uncertainty bound (proportional to the square root of the noise power, \sqrt{N}). By expressing this amount of information in bits, the base-2 logarithm of the number of levels should be taken, and it gives the following expression of the amount of information associated to one sample of the received signal:

Scenario:

aggressor



vs.



victim

Spread Spectrum is not cheating!

Scenario:

aggressor



vs.

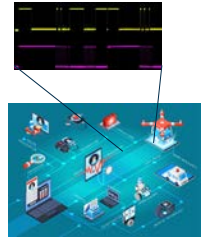

victim

Baseband Digital Communication (uncoded)

Switching-mode power supply

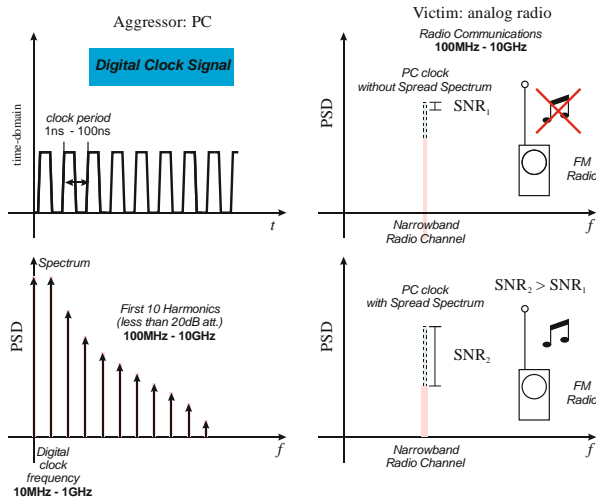

Fig.8 Application scenario: digital equipment interfering with analog radio and effectiveness of SS-modulation considered in [36].

EMI power, suggests an increased interfering potential of SS modulated signals, which is in contrast to what expected based on standard EMC tests. If the spreading bandwidth is further increased, the channel capacity starts increasing, since part of the EMI power is pushed outside the channel bandwidth, thus resulting in an increased signal-to-noise ratio. The increase of channel capacity with the spreading factor, however, is very slow and it is almost insignificant for a spreading bandwidth below 2X-3X of the signal bandwidth.

V. Real-World Application Scenarios

The results discussed in Sect.IV suggest that SS cannot be regarded as a panacea to address interference with communication systems and can possibly worsen the interference potential of switching signals. To gain more insight in such results and on the effectiveness of SS different real-world application scenarios will be compared in what follows.

a) Analog FM Radio and TV

We start considering the scenario depicted in Fig.8. Here, a personal computer (PC) with a clock in the 10 MHz range interferes with an analog FM radio placed nearby. The effectiveness of SS modulations in this scenario can be verified by a simple experi-

Spread Spectrum does not reduce the EMI-induced Bit Error Rate (BER)

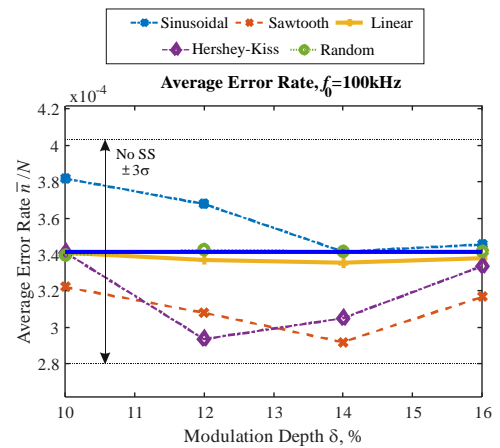
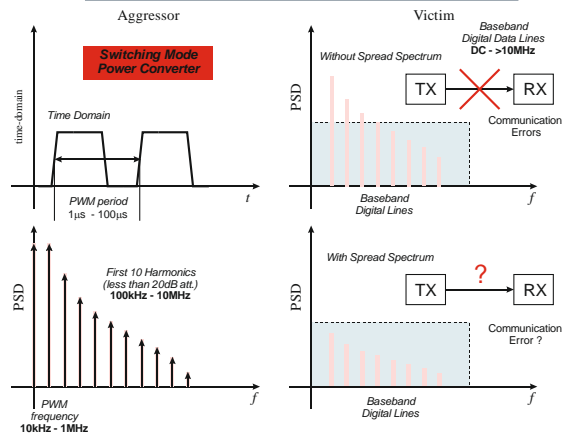

Fig.9 Application scenario: switching-mode power converter interfering with an uncoded baseband digital communication channel, considered in [33] and revealing no improvement from the adoption of SS modulations.

ment (that has been actually suggested in [36]). If the PC is operated by a periodic clock signal (i.e. without SS), and the FM radio is tuned to the PC clock frequency, the operation of the radio can be easily impaired by EMI. By contrast, under the same EMI coupling, if a SS modulation is applied to the PC clock, the functionality of the radio can be fully recovered. In this case, since the spectrum of the radio channel is very narrow (9 kHz) SS with a modulation index of 1% is sufficient to convey most of EMI energy out of the radio channel, thus effectively increasing the in-

Scenario:

aggressor



vs.

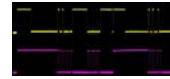

victim

Baseband Digital Communication (with Turbo code)

Switching-mode power supply

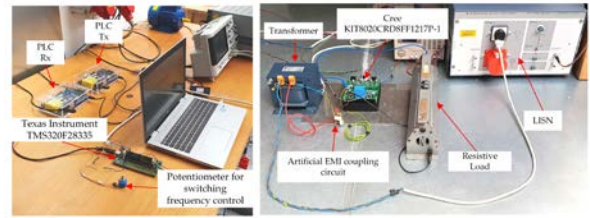

Spread Spectrum results in an increased Bit Error Rate (BER)

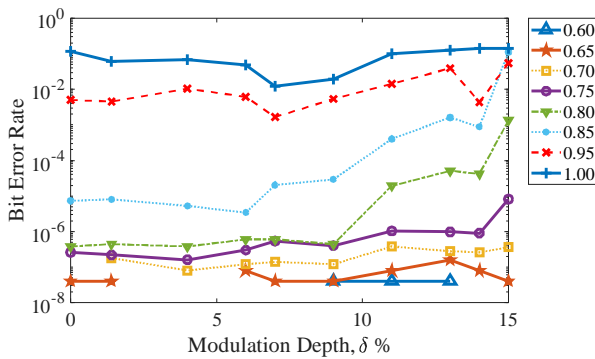

Fig.10 Application scenario: switching-mode power converter interfering with a baseband digital communication channel featuring advanced channel coding (Turbo Coding) achieving a bit rate close to the theoretical Shannon limit [16]. In this case, the adoption of SS modulation is detrimental since it gives rise to an increased BER.

band SNR above the threshold requested for analog communications, as depicted in Fig.8.

In this scenario, which is actually the typical interference scenario considered in the development of EMC standards, we have therefore to conclude with the authors of [36] that SS is not cheating, since it provides a valuable solution to a practical interference problem.

b) Interference with digital data lines

A different interference scenario is illustrated in Fig. 9, where a switching-mode power converter operated at a frequency in the 100 kHz range, with harmonics in the 100 kHz-1 MHz bandwidth, is located close to a baseband digital link with a 1 MHz-bandwidth.

Looking at the spectra of aggressor and victim signals in Fig. 9, the situation is rather different compared to Fig.8. The bandwidth of the communication channel in this case is much larger than the EMI bandwidth and several EMI harmonics fall in it, so the effectiveness of SS modulations is not obvious and the channel capacity analysis presented in Sect.IV and in [16] suggests a worse impairment for SS modulated EMI.

This investigation has been presented in [33], with reference to an inter-integrated circuit communication (I2C) bus intentionally designed to interfere with the disturbances generated by a

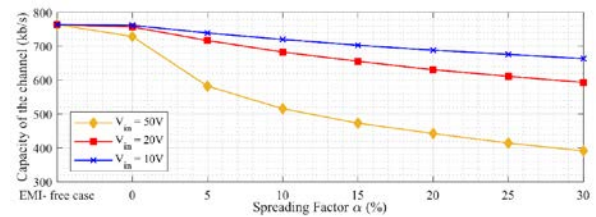
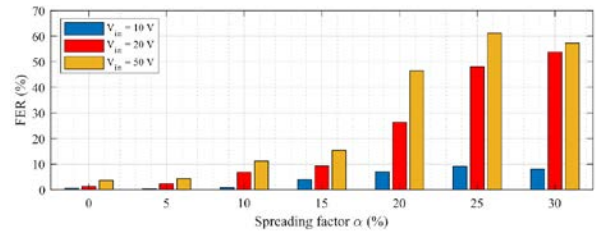

Fig.11 Application scenario: G3 Power Line Communication (PLC) system [28]. The G3 PLC systems features advanced forward error correction (FEC) coding. A detrimental effect of SS modulation is observed as in Fig.10.

switching-mode power supply, which could be either periodic or SS-modulated with different modulation profiles and modulation depth. Based on the experimental results presented in [33] and reported in Fig.9 for convenience, it can be observed that EMI from the power converter gives rise to transmission errors in the digital link, with a bit error rate (BER) depending on the EMI amplitude and coupling. By repeating the same experiment with and without SS, however, unlike in the FM radio case, no noticeable difference in the bit error rate is observed. The experiment was repeated under many different SS-modulation profiles and under different modulation depths, but the result was always the same: no improvement is observed when using SS modulations. The results reported in [32] for digital television, in [34] for an FPGA-based system and in [35] for a TLL-compatible digital link lead to a similar conclusion.

Based on our information theoretical analysis, we found that, in this case, SS EMI gives rise to a worse EMI-induced capacity loss compared to non-modulated EMI. By the way, the experimental BER we obtained in the I2C experiment is not degraded by SS, but it remains constant. This can be explained considering that the Shannon capacity is the upper bound of the achievable bit rate. If the channel is sub-optimally operated at a bit rate much lower than the Shannon capacity limit, the EMI-induced capacity degradation predicted in theory does not imply an increased BER in the practical channel. And this is actually what can be observed in Fig.9.

c) Digital communications featuring advanced channel coding

On the other hand, if very efficient channel coding is adopted to operate the channel at a bit rate close to the Shannon limit (e.g. if Turbo Codes [37] are employed), the EMI-induced reduction in the channel capacity predicted in theory is expected to result in an increased BER. This is actually what can be observed from measurements performed on the same data line using Turbo codes [16], whose results are reported in Fig.10: the BER increases with the SS modulation depth δ . Previous studies on wireless local area networks (WLANs) [26] and on ultra-wide bandwidth (UWB) communication systems [27] featuring Orthogonal Frequency Division Multiplexing (OFDM) report the same behavior.

The potential interference of SS EMI and advanced communication systems is particularly critical in the emerging smart grid environment (Fig.11), where switching mode power converters operated at frequencies in the 10 kHz-1 MHz range are adopted for power management, and the same power grid is exploited for digital power line communications (PLC) using modems, which feature forward error correction codes.

With reference to the PLC scenario, the effectiveness of SS modulations has been experimentally tested in [28] and confirmed in [29] for a G3 PLC system interfering with a Buck power converter.

Measured results on the data link considered in [28] are reported in Fig.11 and show a significant degradation of the bit error rate of up to 50% by increasing the SS spreading factor from zero up to 30% under the same total EMI power, which fairly matches the predicted EMI-induced capacity loss. This result is expected since advanced channel coding achieving a bit rate close to the capacity limit is employed in G3 PLC systems.

More theoretical and experimental results presented in other works on the PRIME PLC system [30], and other works on G3 PLC considering different power converters, SS modulations and/or EMI coupling mechanisms of practical interest [31] confirm the validity of what discussed.

VI. Conclusions and take-home messages

Based on the theoretical insight and on the experimental results presented in this paper, the effectiveness of SS modulations in reducing the interference potential of disturbances is strongly related to the application scenario.

In particular, SS modulations help in complying with EMC standard requirements, and also help in avoiding or limiting interference with analog radio and communication systems, which are actually the victim equipment targeted by the EMC standards. While considering digital communications, however, no improvement can be expected by the adoption of SS modulations and such modulations cannot be of help in solving real-world interference issues between switching mode power converters and/or digital circuits with digital data links.

In particular, the adoption of SS modulation can be even detrimental for digital communication systems adopting advanced coding schemes (e.g. PLC systems), where the worse EMI-induced capacity loss brought about by SS results in an increased BER.

From a more general point of view, it can be concluded that EMC requirements need to be always considered in the framework of a specific interference scenario, and the conclusions that can be valid for one scenario could be possibly not valid in other cases. Nowadays, we are experiencing fast and radical changes in electric and electronic systems arena, which are related to the development and the diffusion of new semiconductor technologies and applications (IoT sensor nodes [38] including EMI-sensitive amplifiers [39], wireless and wired Digital Data lines [26], the smart grid [28], Digital Radio/TV [25], Electric Vehicles [40]), different EMC challenges are emerging, which require new research efforts, new countermeasures and possibly also new regulation requirements.

References

- [1] J. G. Allen, "Radio Interference," in Proceedings of the Institute of Radio Engineers, vol. 17, no. 5, pp. 882-891, May 1929
- [2] L. F. Curtis, "Electrical Interference in Motor Car Receivers," in Proceedings of the Institute of Radio Engineers, vol. 20, no. 4, pp. 674-688, Apr. 1932
- [3] H. Chung, S. Y. R. Hui and K. K. Tse, "Reduction of power converter EMI emission using soft-switching technique," in IEEE Transactions on Electromagnetic Compatibility, vol. 40, no. 3, pp. 282-287, Aug. 1998
- [4] Y. Villavicencio, F. Musolino and F. Fiori, "Electrical Model of Microcontrollers for the Prediction of Electromagnetic Emissions," in IEEE Transactions on Very Large Scale Integration (VLSI) Systems, vol. 19, no. 7, pp. 1205-1217, Jul. 2011.
- [5] F. Pareschi, R. Rovatti and G. Setti, "EMI Reduction via Spread Spectrum in DC/DC Converters: State of the Art, Optimization, and Tradeoffs," in IEEE Access, vol. 3, pp. 2857-2874, 2015
- [6] Feng Lin and D. Y. Chen, "Reduction of power supply EMI emission by switching frequency modulation," in IEEE Transactions on Power Electronics, vol. 9, no. 1, pp. 132-137, Jan. 1994, doi: 10.1109/63.285504.
- [7] K. B. Hardin, J. T. Fessler and D. R. Bush, "Spread spectrum clock generation for the reduction of radiated emissions," Proceedings of IEEE Symposium on Electromagnetic Compatibility, 1994, pp. 227-231
- [8] MIL-STD-461, Military Standard: Electromagnetic Interference Characteristics Requirements for Equipment, Department of Defense, USA, 2015.
- [9] 'Council Directive 89/336/EEC on the approximation of the laws of the Member States relating to EMC', Official J. Eur. Union, Tech. Rep. L139/19, May 1989.
- [10] CISPR 16-1-1:2019 Specification for radio disturbance and immunity measuring apparatus and methods – Part 1-1: Radio disturbance and immunity measuring apparatus – Measuring apparatus, IEC, 2019.
- [11] CISPR 11:2015 Industrial, scientific and medical equipment - Radio-frequency disturbance characteristics - Limits and methods of measurement, IEC, 2015
- [12] CISPR 25:2016 Vehicles, boats and internal combustion engines - Radio disturbance characteristics - Limits and methods of measurement for the protection of on-board receivers, IEC, 2016.
- [13] FCC, Electronic Code of Federal Regulations, Title 47, Part 15, Radio Frequency Devices, USA, 2021.
- [14] C.E.Shannon, "A Mathematical Theory of Communication," in *The Bell System Technical Journal*, vol. 27, pp.379-423, July 1948.
- [15] Cover and Thomas, "Elements of Information Theory", Wiley Series in Telecommunications and Signal Processing, 1991, Wiley, New York.
- [16] F. Musolino and P. Crovetto, "Interference of Spread-Spectrum Modulated Disturbances on Digital Communication Channels," in IEEE Access, vol. 7, pp. 158969-158980, 2019

[17] Croveti, P.S.; Musolino, F. Interference of Spread-Spectrum EMI and Digital Data Links under Narrowband Resonant Coupling. *Electronics* 2020, 9, 60.

[18] Henry W. Ott, *Electromagnetic Compatibility Engineering*, Wiley, New York, 2009

[19] Heimann, D., M. Stecher, "A History of the Evolution of EMC Regulatory Bodies and Standards," Zurich EMC Symposium, 2005.

[20] K.K. Tse, H.S.-Chung, S.Y. Huo and H.C. So, "Analysis and spectral characteristics of a Spread-Spectrum technique for conducted EMI suppression," in *IEEE Trans. Power Electron.*, vol. 15, no.2, pp. 399-410, Mar. 2000.

[21] R. Mukherjee, A. Patra and S. Banerjee, "Impact of a Frequency Modulated Pulse-width Modulation (PWM) Switching Converter on the Input Power System Quality," in *IEEE Transactions on Power Electronics*, vol. 25, no. 6, pp. 1450-1459, June 2010.

[22] Texas Instruments, EMI Reduction Technique, Dual Random Spread Spectrum, Application Report SNVA974, June 2020

[23] STM32 MCUs spread-spectrum clock generation principles, properties and implementation", Application Note AN4850, STMicroelectronics, Jul.2016.

[24] Multiphase Oscillator With Spread Spectrum Frequency Modulation, document LTC6902, Linear Technology, 2003, [online] Available: <http://cds.linear.com/docs/en/datasheet/6902f.pdf>.

[25] D.Lauder, and J.Moritz, "Investigation into Possible Effects Resulting From Dithered Clock Oscillators on EMC Measurements and Interference to Radio Transmission Systems," Radiocommunications Agency, London, U.K., RA REF: AY3377 (510 001 891)

[26] Y. Matsumoto, T. Shimizu, T. Murakami, K. Fujii and A. Sugiura, "Impact of Frequency-Modulated Harmonic Noises From PCs on OFDM-Based WLAN Systems," in *IEEE Transactions on EMC*, vol. 49, no. 2, pp. 455-462, May 2007

[27] Y. Matsumoto, K. Fujii, A. Sugiura and Takahide Murakami, "Impact of electromagnetic noises from PCs on the performance of MB-OFDM UWB systems," 2009 IEEE 13th International Symposium on Consumer Electronics, 2009, pp. 430-433

[28] W. E. Sayed, P. Lezynski, R. Smolenski, N. Moonen, P. Croveti, and D. W. P. Thomas, "The Effect of EMI Generated from Spread-Spectrum-Modulated SiC-Based Buck Converter on the G3-PLC Channel," *Electronics*, vol. 10, no. 12, p. 1416, Jun. 2021.

[29] W. El Sayed, P. Croveti, N. Moonen, P. Lezynski, R. Smolenski and F. Leferink, "Electromagnetic Interference of Spread-Spectrum Modulated Power Converters in G3-PLC Power Line Communication Systems," in *IEEE Letters on Electromagnetic Compatibility Practice and Applications*, vol. 3, no. 4, pp. 118-122, Dec. 2021

[30] W. El Sayed, P. Croveti, P. Lezynski, R. Smolenski, A. Madi and F. Grassi, "The Influence of Commercial PC Switched Mode Power Supply Interference on the PRIME PLC Performance," 2021 IEEE International Joint EMC/SI/PI and EMC Europe Symposium, 2021, pp. 632-636

[31] W. E. Sayed, P. Lezynski, R. Smolenski, A. Madi, M. Pazera, and A. Kempski, "Deterministic vs. Random Modulated Interference on G3 Power Line Communication," *Energies*, vol. 14, no. 11, p. 3257, Jun. 2021.

[32] K.Hardin, R.A.Oglesbee and F.Fisher, "Investigation into the interference potential of spread-spectrum clock generation to broadband digital communications," in *IEEE Transactions on Electromagnetic Compatibility*, vol. 45, no. 1, pp. 10-21, Feb 2003.

[33] F. Musolino and P. S. Croveti, "Interference of Spread-Spectrum Switching-Mode Power Converters and Low-Frequency Digital Lines," 2018 IEEE International Symposium on Circuits and Systems (ISCAS), Florence, Italy, 2018, pp. 1-5.

[34] H. Loschi, P. Lezynski, R. Smolenski, D. Nascimento, and W.Sleszynski, "FPGA-Based System for Electromagnetic Interference Evaluation in Random Modulated DC / DC Converters," *Energies* 2020, vol. 13, no. 2389, pp. 1-14, 2020.

[35] Pena-Quintal, A., Niewiadomski, K., Muneeswaran, V., Greedy, S., Sumner, M., Thomas, D.W.P., "The Effect of Spread Spectrum Modulation for a Buck Converter Coupled with a Single Wired Communication Link", 2021 Joint IEEE International Symposium on Electromagnetic Compatibility Signal and Power Integrity, and EMC Europe, EMC/SI/PI/EMC Europe 2021, pp. 445-450.

[36] H. G. Skinner and K. P. Slattery, "Why spread spectrum clocking of computing devices is not cheating," 2001 IEEE EMC International Symposium. Symposium Record. International Symposium on Electromagnetic Compatibility (Cat. No.01CH37161), 2001, pp. 537-540 vol.1.

[37] C. Berrou, A. Glavieux, and P. Thitimajshima, "Near Shannon limit error correcting coding and decoding: Turbo-codes. 1," in *Proc. IEEE Int. Conf. Commu.*, Geneva, Switzerland, May 1993, pp. 1064-1070

[38] M. Alioto, *Enabling the Internet of Things—From Integrated Circuits to Integrated Systems*, Cham, Switzerland:Springer, 2017.

[39] P. Croveti and F. Musolino, "Digital Suppression of EMI-Induced Errors in a Base-band Acquisition Front-End including Off-the-Shelf, EMI-Sensitive Operational Amplifiers," *Electronics*, vol. 10, no. 17, p. 2096, Aug. 2021.

[40] O. Aiello and P. Croveti, "Characterization of the Susceptibility to EMI of a BMS IC for Electric Vehicles by Direct Power and Bulk Current Injection," in *IEEE Letters on Electromagnetic Compatibility Practice and Applications*, vol. 3, no. 3, pp. 101-107, Sept. 2021



Paolo S. Croveti (S'00-M'04-SM'20) was born in Turin, Italy, in 1976. He received the Laurea (summa cum laude) and Ph.D. degrees in electronic engineering from the Politecnico di Turin, Turin, Italy, in 2000 and 2003, respectively. He is currently an Associate Professor with the Department of Electronics and Telecommunications (DET), Politecnico di Torino, Turin where he leads a research group in Analog, Mixed-Signal and Power microelectronics with several international collaborations and teaches courses on basic and automotive electronics. He has co-authored more than 75 papers appearing in journals and international conference proceedings. In 2009 and in 2019 he was corecipient of the excellent paper award of the EMC'09 Kyoto Symposium and of the Best Student Paper Award of the International Symposium of Circuits and Systems ICECS 2019. His main research interests are in the fields integrated circuit design and electromagnetic compatibility. His recent research activities are focused on non-conventional digital-based information processing techniques and ultra-low-voltage, ultra-low-power IC design for the Internet of Things. Prof. Croveti is the Subject Editor-in-Chief of IET Electronics Letters in the area of Circuits and Systems and is an Associate Editor of the IEEE Transactions on Very Large Scale of Integration Systems.

Francesco Musolino (S'01-M'03) was born in Torino, Italy in 1972. He received the Laurea and Ph.D. degrees in electronic engineering from the Politecnico di Torino, Torino, Italy, in 1999 and 2003, respectively. He is currently a Researcher with the Department of Electronics and Telecommunications (DET), Politecnico di Torino, Torino where he teaches courses on power electronics and electronics for electric drives. His research interests include electronics for power conversion and motor drive applications, mixed-signal circuits, electromagnetic compatibility at the system levels and the analysis, modeling, and experimental characterization of electromagnetic compatibility problems at the printed circuit board and package level.



Francesco Musolino (S'01-M'03) was born in Torino, Italy in 1972. He received the Laurea and Ph.D. degrees in electronic engineering from the Politecnico di Torino, Torino, Italy, in 1999 and 2003, respectively. He is currently a Researcher with the Department of Electronics and Telecommunications (DET), Politecnico di Torino, Torino where he teaches courses on

power electronics and electronics for electric drives. His research interests include electronics for power conversion and motor drive applications, mixed-signal circuits, electromagnetic compatibility at the system levels and the analysis, modeling, and experimental characterization of electromagnetic compatibility problems at the printed circuit board and package level.