

Sustainable production networks: A design methodology based on the cooperation among stakeholders

Original

Sustainable production networks: A design methodology based on the cooperation among stakeholders / Castiglione, C., Fiore, E.. - In: JOURNAL OF CLEANER PRODUCTION. - ISSN 0959-6526. - 362:(2022), p. 132308. [10.1016/j.jclepro.2022.132308]

Availability:

This version is available at: 11583/2971291 since: 2023-02-15T13:45:15Z

Publisher:

ELSEVIER SCI LTD

Published

DOI:10.1016/j.jclepro.2022.132308

Terms of use:

This article is made available under terms and conditions as specified in the corresponding bibliographic description in the repository

Publisher copyright

Elsevier postprint/Author's Accepted Manuscript

© 2022. This manuscript version is made available under the CC-BY-NC-ND 4.0 license
<http://creativecommons.org/licenses/by-nc-nd/4.0/>. The final authenticated version is available online at:
<http://dx.doi.org/10.1016/j.jclepro.2022.132308>

(Article begins on next page)

1 **Word count: 8831**

2 **Sustainable production networks: a design methodology based on the cooperation among stakeholders**

3

4 **Abstract**

5

6 This paper proposes an approach based on a systemic design methodology and the Multi-layer Enterprise
7 Input-Output formalisation method to engage different stakeholders in a new production network to create
8 value from waste and by-products. The proposed methodology supports the stakeholders' cooperation in
9 the design and development phases to establish, in a bottom-up fashion, production networks based on
10 mutual stakeholders' trust and relevant innovation content, such as industrial symbioses. The systemic
11 design approach focuses on the characteristics of the local communities and their know-how identifying
12 current waste and potential alternatives to exploit them as raw materials. A novel hierarchical version of the
13 Multi-layer Enterprise Input-Output formalisation method quantitatively supports the system design and the
14 performance assessment. It increases data consistency, supports practitioners in system formalisation, and
15 feeds a properly developed dashboard of KPIs to provide the stakeholders with systemic design information
16 and system techno-economic-environmental performance. The methodology implementation is shown in a
17 case study based on the regional project InnovaEcoFood, which analyses the technical feasibility of producing
18 healthy products from wine press residue and rice bran. The methodology data structure appears suitable
19 for dynamic analyses to support decision-making, performance assessment, negotiation, and development
20 activities. The methodology engages stakeholders in the design and development process, providing
21 consistent techno-economic-environmental data based on a shared platform. In particular, it is suitable for
22 self-organising networks and models where stakeholders themselves engage partners to build and extend
23 the network.

24 **keywords: Sustainable production systems; Industrial symbiosis; Systemic design; Eco-efficiency;**
25 **Sustainability indicators; Holistic diagnosis.**

26

27 **1. Introduction**

28

29 Sustainable development merges the environmental and social dimensions with the economic growth of
30 human activities. It was defined in 1987 (United Nations General Assembly, 1987) as the development that
31 'meets the needs of the present without compromising the ability of future generations to meet their own
32 needs.' Nowadays, the sustainable development definition has been extended by introducing the 17
33 Sustainable Development Goals for 2030, set by United Nations (United Nations, 2015), which tightly
34 intertwine industrial and infrastructure innovation and the positive impacts on the local communities and
35 the environment.

36

37 Circular economy, industrial ecology, and systemic design are among the most popular paradigms for
38 designing sustainable production networks. The circular economy paradigm fosters the adoption of cleaner
39 production patterns at the company level and designing bottom-up environmental and waste management
40 policies (Ghisellini et al., 2016). Although waste management represents only one aspect of circular economy
41 and sustainability, recycling, reuse, and resource reduction play a pivotal role (Kirchherr et al., 2017),
42 fostering sustainable development by addressing regenerative systems, waste reduction and resource
43 efficiency improvement (Geissdoerfer et al., 2017). Industrial ecology investigates the mutual interaction
44 between environmental and human ecosystems by focusing on materials and energy exchange (Saavedra et
45 al., 2018). The systemic design aims to create new production networks through the cooperative connections
46 of stakeholders capable of exploiting one the waste of another by ensuring that the new systems can self-
47 adapt and self-organise. This approach shifts the focus from the product to the territory and the potential
48 connections that can be established among stakeholders to gain diversity, efficiency, adaptability, and
49 cohesion (Fiore et al., 2020).

50

1 The systemic design (SD) derives from von Bertalanffy's General System Theory (1969), which successively
2 applied to the intersection of several research fields such as ecology, technology, and eco-management. Like
3 industrial ecology, SD deals with artificial systems that evolve, and a specific methodology has been
4 developed for dealing with production systems and value chains (Barbero, 2015). This methodology is based
5 on the following five principles (Bistagnino, 2011):

- 6 1. The output (side-streams or by-products) of a system becomes the input (raw material) for another
7 to create positive impacts such as increased turnover and new jobs.
- 8 2. Each relationship contributes to the system, which can be within or outside of the system.
- 9 3. Self-producing systems evolve by defining their paths of action and their interactions with other
10 systems. Therefore, industries connected in a systemic approach are in dynamic balance and will
11 change their role within the system to adapt themselves to the continuous changes of the
12 environmental conditions (e.g., market, supply chains);
- 13 4. Stakeholders act locally: consolidating local networks gives value to the local resources (e.g. human,
14 culture and material), highlighting local needs and opportunities by including them in the analysis.
- 15 5. Local communities act at the centre of the project and shall be connected to their own
16 environmental, social and cultural context.

17 Therefore, the SD approach carefully considers the social dimension of sustainable development by
18 including many social factors such as the local direct and indirect job creation, the local culture and products
19 such as food and the know-how. Moreover, the approach based on stakeholders' engagement may
20 effectively design and develop networks where trust among stakeholders must be developed. Innovation is
21 pivotal at the technological, business model, and operational levels, such as in the industrial symbioses.

22
23 However, the SD approach lacks quantitative assessment methods to investigate and quantify system
24 performance. New proposed alternatives should be comparable to support the practitioners in designing a
25 well-performing system. In addition, during the design of a new system integrating several existing systems,
26 involved stakeholders may require quantitative evidence regarding economic and environmental strengths
27 and weaknesses to compare the current condition with the proposed alternatives.

28
29 This study investigates the exploitation of the Multi-layer Enterprise Input-Output (MEIO) formalisation
30 method, which is used in production planning and control systems to simultaneously assess system
31 performance under technical, economic, and environmental dimensions (Castiglione et al., 2022), as a
32 quantitative tool to support SD in the design of sustainable production systems. Specifically, the MEIO
33 method is used to support practitioners in identifying resource flows and estimating the performance of the
34 current production system and the improving alternatives by developing a set of Key Performance Indicators
35 (KPIs). Differently from other sets of KPIs proposed in the literature, such as regulatory indicators (e.g., Tian
36 et al., 2014) and those developed through the use of Environmental Network Analysis (ENA), for example, to
37 optimise networks (Layton, Bras, & Weissburg, 2016) and investigate the changes in resource flows (Malone,
38 Weissburg, & Bras, 2018), the proposed KPIs focus on the development phase. Although the proposed
39 method does not exclude the possibility of conducting further analyses with other sets of KPIs, it aims to
40 support all the engaged stakeholders' during the design and development phase. Hence, the KPIs mainly
41 focus on providing information about the performance of the potential networks under analysis and their
42 relationships with the local context rather than a global *a posteriori* perspective like in Mattila, Pakarinen, &
43 Sokka 2010. The use of the MEIO method within the SD approach and the proposed KPIs are shown through
44 the case study of the project InnovaEcoFood.

45
46 In the remainder of this study, Section 2 presents the literature review and the research gap, while
47 Section 3 shows the integration of the MEIO formalisation method and the SD methodology. Section 4
48 presents the empirical context and the case study. Section 5 discusses the results and section 6 concludes
49 this paper.

50 51 **2. Literature review**

52

1 The transition toward sustainable development affects the design of production networks. However,
2 achieving 'zero waste' could be considered economically unsustainable for stand-alone companies (Pauli,
3 1997); hence, the interaction strategies among different companies play a pivotal role in the literature. The
4 main strategies, which involve more than one company, regard the development of new products, the supply
5 chains improvement to optimise resource exploitation and the development of networks able to use
6 produced waste as raw material. Life cycle engineering approaches help to reduce environmental impact and
7 foster circular economy strategies focusing on the product and analysing each phase of the product life cycle
8 (Bradley et al., 2018) to limit the sources of waste during the entire product lifecycle (Brundage et al., 2018)
9 and facilitating the companies that will exploit the product after the customer's use to avoid its disposal off
10 (Sonego et al., 2018). The exploitation of waste and by-products to improve the efficient use of the resources
11 and reduce the consumption of virgin materials require the design of new systems and supply chains capable
12 of implementing the 6Rs strategies of circular economy, namely, reduction, reuse, recycling, recovery,
13 redesign, re-manufacture (Govindan and Hasanagic 2018). Furthermore, companies can cooperate to make
14 networks of industrial symbiotic relationships (i.e., industrial symbiosis studied by industrial ecology) where
15 waste produced by a company becomes raw materials for another (Chertow and Ehrenfeld, 2012).

16
17 The main difference between supply chains that implement the previously introduced 6Rs strategies and
18 industrial symbiosis networks (ISN) is that all the supply chain stakeholders are oriented to the satisfaction
19 of the same customers. In contrast, in an ISN, each company focuses on its customers' satisfaction (Stefan
20 Seuring, 2004). Therefore, the environmental performance of ISN is intertwined and limited to the economic
21 gain achieved by the single stakeholders (Scott Victor Valentine, 2016). However, considering supply chains
22 and ISNs holistically can increase the economic and environmental performance of the involved stakeholders
23 (Herczeg et al., 2018), especially when they are jointly designed and developed (Castiglione and Alfieri, 2019).
24 The relationships among stakeholders play a fundamental role in this context because companies set part of
25 their innovation strategies and investment allocation according to the development of the network
26 (Castiglione et al., 2021), and they can be injured by the propagation of disruptive events that can affect the
27 network by moving costs from a stakeholder to another (Yazan and Fraccascia, 2020).

28
29 Local authorities and governments foster cooperation among stakeholders and companies, whether in
30 the product development process or supply chains and ISNs, to improve the exploitation of local resources,
31 enhance value creation, and reduce waste disposal (Allais et al., 2015). However, interactions among
32 stakeholders are mainly studied by analysing the resource flows to improve the network resilience, matching
33 the waste production and its use as raw material, and preventing the onset of opportunistic behaviours.
34 Social network analysis has been used to investigate the centrality of some companies within the networks
35 and identify their characteristics (Song et al., 2018). ENA methods investigate the benefits and weaknesses
36 of the network characteristics, such as nestedness (Chatterjee, Brehm, & Layton, 2021). Also, ENA methods
37 help to analyse and design the networks by focusing on their resilience (Chatterjee & Layton, 2020) and
38 robustness (Dave & Layton, 2020) capabilities. For example, Food Web Analysis (one of the ENA methods) is
39 used to study the network resilience regarding the capability of absorbing waste even though the occurrence
40 of disruptive events (Genc et al., 2019) and identify detrital actors capable of fostering resource circularity
41 (Watson et al., 2020).

42
43 Enterprise Input-Output models have been used to identify and analyse a set of companies capable of
44 creating synergies by exploiting their waste (Fraccascia, 2019), combined with Multi-Agent models to
45 introduce the companies' behaviours (Albino et al., 2016). Game theory approaches are used to define
46 equilibrium conditions to prevent opportunistic behaviours, while commitment-keeping mechanisms
47 incentivise the companies to cooperate (Castiglione and Alfieri, 2020).

48
49 However, these approaches neglect the local traditions and know-how, the strengths and weaknesses of
50 a particular region, and the local communities. Conversely, SD approaches consider these aspects by fostering
51 the active involvement of the local stakeholders in the design and development phases.

52

1 SD approaches are increasingly reaching the interest of scholars and practitioners that deal with *open*
2 systems, that is, self-adaptable and self-organising systems over time (Hadžikadić, 2017) whose goal goes
3 beyond closing the resource loops. The Systemic Design Research Network (SDRN)¹ has investigated these
4 approaches since 2012², and it has been recently formalised into the Systemic Design Association (SDA),
5 which was created in 2018 by featuring the Oslo School of Architecture and Design (AHO), Ontario College of
6 Art and Design University in Toronto (OCAD) and Politecnico di Torino in Italy (Battistoni et al., 2019). SD
7 approaches developed by different research groups focus on framing complex problems and solutions³,
8 which led to the creation of several degree programmes held in international universities, such as (i) a
9 Strategic Foresight and Innovation master program at OCAD University of Toronto⁴, led by Peter Jones,
10 addressing the complexity by investigating the causal links (Jones, 2014), (ii) Systems Oriented Design at
11 AHO, Norway⁵, held by Birger Sevaldson, facing with socio-cultural-economic-environmental systems, (iii) a
12 Master Degree in Systemic Design at the Politecnico di Torino, in Italy⁶, held by Silvia Barbero, that aims at
13 defining production systems in which the output of a system becomes input, by viewing discarded output as
14 a valuable resource for the local communities (Bistagnino, 2011), (iv) master degrees at the National Institute
15 of Design (NID)⁷, India, lead by Praween Nahar⁸. Moreover, Alex Ryan⁹ leads a group of systemic designers at
16 the Government of Alberta (Alberta CoLab)¹⁰.

17
18 The tools developed in the several SD approaches for framing the existing systems usually rely on the
19 designer's ability to visualise the problem and graphically shape the complexity (Pereno and Barbero, 2020).
20 The most famous tools are the synthesis maps (Jones & Bowes, 2016) or giga mapping (Sevaldson, 2018),
21 and the holistic diagnosis, which allows the "analysis and visualisation of all the components that define the
22 current scenario, considering both the surrounding context and the flow of energy and matter" to provide a
23 holistic picture of the state-of-the-art and the advantages for change (Battistoni, Giraldo Nohra, & Barbero,
24 2019).

25
26 This paper contributes to the literature by investigating the use of an SD methodology enriched with an
27 improved version of the MEIO formalisation method and a new dashboard of KPIs to design open systems
28 capable of exploiting the waste and by-products as new raw materials by also including some factors poorly
29 considered in the literature, such as the local culture, know-how, and traditions. These factors are crucial for
30 establishing industrial symbiosis because they address two relevant and hard to investigate issues: reducing
31 the "mental distance" and improving trust among stakeholders (Yeo et al., 2019).

32 The SD methodology used in this paper consists of a six-phase framework whose application and final
33 result partially depend on the designer's skills. The integration with the MEIO formalisation method
34 overcomes the lack of quantitative tools of SD approaches quantitatively supporting the designers in the data
35 collection, assisting the formalisation phases, and providing policy-makers and stakeholders with
36 quantitative evidence on the alternatives for improving the system. Furthermore, the quantitative evidence
37 can also encourage companies and entrepreneurs to keep their commitment in the open system
38 development.

¹ <https://systemic-design.org> [Accessed 20 July, 2021]

² <https://systemic-design.org/systemic-design-association/> lo [Accessed 20 July 2021]

³ <https://systemic-design.org/systemic-design-association/> lo [Accessed 20 July 2021]

⁴ <https://www.ocadu.ca/academics/graduate-studies/strategic-foresight-and-innovation> [Accessed 2 September 2021]

⁵ <https://aho.no/no/courses/70-504/2017-host>. [Accessed 17 August 2021]

⁶ https://didattica.polito.it/laurea_magistrale/design_sistemico/en/presentation [Accessed 17 August 2021]

⁷ <https://www.nid.edu/home> [Accessed 22 August 2021]

⁸ <https://www.nid.edu/people/detail/praveen-nahar> [Accessed 22 August 2021]

⁹ <https://www.marsdd.com/bio/alex-ryan/> [Accessed 22 August 2021]

¹⁰ <https://open.alberta.ca/publications/systemic-design-alberta-colab-info-sheet> [Accessed 22 August 2021]

1 This paper introduces an improved version of the MEIO method to hierarchically support the different
2 phases of the SD approach and adapt to different stakeholders' use. It aims to assist both the data collection
3 activities and the evaluation of the identified alternatives by adapting to the level of detail required by each
4 specific stakeholder.

5 Also, this paper presents a dashboard of KPIs developed to be easily calculated and updated during the
6 exploitation of the MEIO method. The dashboard provides technical, economic, environmental and systemic
7 design information relevant to support the phases of establishing the production network by focusing on
8 each stakeholder's involvement.

9 **3. Materials and methods**

10
11 This section briefly summarises the six-step SD framework and the MEIO method to support the introduction
12 of the novel methodology based on the SD framework itself, the novel hierarchical version of the MEIO
13 method, and the dashboard of KPIs to improve systemic-techno-economic-environmental analyses.

14 **3.1. The systemic design approach**

15
16 SD focuses on the production networks by combining desk and field research and visualisation tools to
17 provide a quali-quantitative vision of the existing system and foster the identification of improving
18 alternatives (Pereno and Barbero, 2020). The proposed methodology is based on the framework developed
19 by Battistoni and colleagues (2019), which consists of the following six steps:

- 20 1. *Holistic diagnosis*. Based on desk and field research, this analysis identifies all the components that
21 define the current scenario, that is, the *linear model* that considers the involved input and output
22 resource flows (i.e., raw materials, finished products, consumables, waste, and by-products), and the
23 surrounding context (e.g., local traditions and know-how).
- 24 2. *Definition of problems and leverages for change*. The *linear model* and the surrounding context are
25 used to identify unexploited resources and their potentialities.
- 26 3. *System design*. This phase focuses on identifying the alternatives, that is, sets of connections
27 involving different stakeholders and processes, to create value from the resources discarded in the
28 *linear model* by exploiting the opportunities offered by the territory. The alternatives transform the
29 *linear model* into a *systemic model*, that is, an *open* system capable of creating value from part of the
30 currently unexploited waste.
- 31 4. *Preliminary outcomes analysis*. Performance assessment of the alternatives under economic,
32 environmental, and social dimensions highlights possible benefits and weaknesses.
- 33 5. *Implementation*. Once an alternative is selected because of its viability and feasibility, the
34 stakeholders implement it.
- 35 6. *Results analysis and feedback*. Data collected during the *Implementation* phase helps to identify new
36 opportunities, making the system autopoietic (i.e., capable of self-improving).

37 38 **3.2. The Multi-layer Enterprise Input-Output formalisation method**

39
40 MEIO is a data formalisation method performing data collection, processing, and conditioning activities. It
41 has been developed in the production planning and control system field to support the assessment of
42 manufacturing system performance. It simultaneously considers value creation and technical, economic, and
43 environmental dimensions (Castiglione et al., 2022) by avoiding adopting several methods together that may
44 lead to redundancies and inconsistencies in data collection, processing, and analysis activities.

45
46 The MEIO method architecture consists of three tables: the Resource-Activity (RA) MEIO table, the Activity-
47 Parameter (AP) MEIO table, and the Resource-Function (RF) MEIO table. They collect information on activities
48 involved in the system (production, transport, and inventory activities) and their relationships with all

1 resources produced and consumed by the system. The three tables are used to create the RA MEIO graph
 2 representing the system under investigation.

3
 4 *RA MEIO table.* RA MEIO table has a column for each activity and a row for each resource involved in the
 5 system to report, through the format “Input/output”, the maximum quantity absorbed in *input* or produced
 6 in *output* by the activity itself, replaced by the middle dash when the resource is absent. Table 1 shows an
 7 example of the RA MEIO table for a system with three activities (production, transport, and inventory activity,
 8 P1, T1, and I1, respectively) and five resources. For example, resource R2 is both input and output of activities
 9 T1 and I1, while, in P1, it is just an output. The RA MEIO table exploits the two principles of Material Flow
 10 Analysis: the input and the output of an activity must correspond according to the energy and the material
 11 balances; the unit of analysis of each resource must be consistent within the entire system. Hence, this
 12 method has no privileged resource (e.g., finished products) as it considers all resources simultaneously.

13
 14 *Table 1. The RA MEIO table for a three-activity and five-resource system.*

RA MEIO table	P1	T1	I1
R1	$input_{R1,P1}/-$	$-/-$	$input_{R1,I1}/-$
R2	$-/output_{R2,P1}$	$input_{R2,T1}/output_{R2,T1}$	$input_{R2,I1}/output_{R2,I1}$
R3	$-/-$	$input_{R3,T1}/-$	$-/-$
R4	$input_{R4,P1}/output_{R4,P1}$	$-/-$	$-/-$
R5	$-/output_{R5,P1}$	$-/-$	$-/-$

15
 16 *AP MEIO table.* This table has the activities in the column and activity parameters in rows. Generally, the first
 17 table rows introduce the activity ID, the machine involved, the number of parallel machines, the operating
 18 costs, operating hours per shift and shifts in a day, the distance matrix between activities reporting whether
 19 two activities are physically connected and the distance between two not connected activities. Table 2 shows
 20 the AP MEIO table of the previous example of the three-activity system. The table is highly customisable to
 21 adapt to the various uses of the method.

22
 23 *Table 2. The AP MEIO table for a three-activity system.*

AP MEIO table	P1	T1	I1
ID	A001	A002	A003
Activity description	Marc grinding	Truck transport	Marc flour bag
Number of machines	2	1	5
Operating costs (€/h)	10	5	1
Distance from P1 (km)	-	0	5
Distance from T1 (km)	0	-	0
Distance from I1 (km)	5	0	-

24
 25
 26 *RF MEIO table.* It follows the same structure as the RA MEIO table, with the activities in the columns and the
 27 resources involved in the system in rows. This table allows analysing of different production rates and scales
 28 of the manufacturing system by varying production and consumption through mathematical functions that
 29 model relationships between consumed and produced resources. In each activity i , one of the produced or
 30 consumed resources is selected as the independent variable X_i , and its produced or consumed quantity is
 31 decided by the decision-maker or in other ways out of the method. The dependent variables $Y_{r,i}$ and $Y'_{r,i}$
 32 represent, respectively, the consumed and the produced quantities of the resource r of activity i . Differently
 33 from the RA MEIO table, the “input;output” format specifies both the proportional quantity produced or
 34 consumed according to the independent variable X_i and potential fixed consumption or production.
 35 Therefore, in each activity i , for each resource r , four parameters $a_{(s,i)}$, $b_{(s,i)}$, $a'_{(i,e)}$, and $b'_{(i,e)}$ are introduced
 36 to model the consumption or the production of r proportional to X_i , respectively, $a_{(s,i)}$ and $a'_{(i,e)}$, and the
 37 potential fixed consumption or production of r , $b_{(s,i)}$ and $b'_{(i,e)}$, respectively. The subscripts of the four

1 parameters identify the starting activities s that produce the resource r followed by the ending activities e
 2 that consume it, and the role of the current activity i . Table 3 shows the RF MEIO table of the previous
 3 example, and for the activity I1, the input quantity of the resource R1 has been chosen as the independent
 4 variable X_{I1} and the input ($Y_{R2,I1}$) and output ($Y'_{R2,I1}$) quantities of R2 dependent proportionally from X_{I1} plus
 5 a fixed consumption and production. The accuracy of mathematical functions can range from a rough linear
 6 estimation for big picture analyses to a high-fidelity representation of the process by exploiting industrial
 7 data or using the producer's nominal information for production machines.

8
 9 *Table 3. The RF MEIO table for a system with three activities and five resources.*

RF MEIO table	P1	T1	I1
R1	$Y_{R1,P1} = a_{(s,P1)} X_{P1} + b_{(s,P1)}$;-	-;-	X_{I1} ;-
R2	-; X_{P1}	$Y_{R2,T1} = a_{(s,T1)} X_{T1} + b_{(s,T1)}$; $Y'_{R2,T1} = a'_{(T1,e)} X_{T1} + b'_{(T1,e)}$	$Y_{R2,I1} = a_{(s,I1)} X_{I1} + b_{(s,I1)}$; $Y'_{R2,I1} = a'_{(I1,e)} X_{I1} + b'_{(I1,e)}$
R3	-;-	X_{T1} ;-	-;-
R4	$Y_{R4,P1} = a_{(s,P1)} X_{P1} + b_{(s,P1)}$; $Y'_{R4,P1} = a'_{(P1,e)} X_{P1} + b'_{(P1,e)}$	-;-	-;-
R5	-; $Y'_{R5,P1} = a_{(P1,e)} X_{P1} + b_{(P1,e)}$	-;-	-;-

10
 11
 12 *RA MEIO graph.* The MEIO tables can be used to create the RA MEIO graph in which the activities and the
 13 resources are the nodes and the arcs, respectively. The RA MEIO graph is both a visual tool and a formal
 14 representation to which the mathematical graph rules can be applied to perform analyses and optimisations.
 15 Arcs connect the node where the resource is produced with the nodes that consume or can consume it. The
 16 RA MEIO graph consists of two subgraphs: one of the current connections among activities (solid arcs) and
 17 one of the potential connections among the activities (dashed arcs) to identify potential alternatives for
 18 reusing waste and by-products. The RA MEIO graph exploits the RA MEIO table to identify dashed arcs, that
 19 is, all the potential connections among the activities producing each resource and the activities that may
 20 exploit them. Conversely, the connections identified in the distance matrix of the AP MEIO table represent
 21 the physical system structure, and they are represented through solid arcs in the RA MEIO graph by defining
 22 the actual connections. Figure 1 shows the RA MEIO graph of the previous example.

23
 24 All the activity input (incoming arcs) and output (outgoing arcs) must have a source and a sink activity. When
 25 the system does not provide a sink or source activity, for example, in Figure 1, when a process dissipates heat
 26 in the environment (resource R5) or absorbs power (resource R1) from the market, a dashed node is
 27 introduced (T6 for R5 and T3 for R1) by putting together all the arcs representing the procurement of the
 28 same resource. The nodes contain the information of the AP MEIO table, such as operating costs, technical
 29 data, and efficiency. AP MEIO table also provides the weight of the dashed arcs, that is, the distance between
 30 two activities or a middle dash when they are not connected. The weights of the solid arcs are given from the
 31 mathematical functions of the RF MEIO table. For example, in Figure 1, the activity P1 exploits some resources
 32 from the market (R1 and R4 coming from T2 and T3, dashed arcs since the current system does not consider
 33 them), emitting in the environment R4 and R5 after the transformation process (T6 and T7). P1 finished
 34 product is currently transported (activity T1) to a warehouse (I1) where it is sold (dashed activity T4), and
 35 solid arcs identify this path. However, other system alternatives might consider selling the product directly
 36 from P1 or storing the product near P1. These system alternatives, represented in dashed arcs, come from
 37 the RA MEIO table by matching the output and the input of different activities.

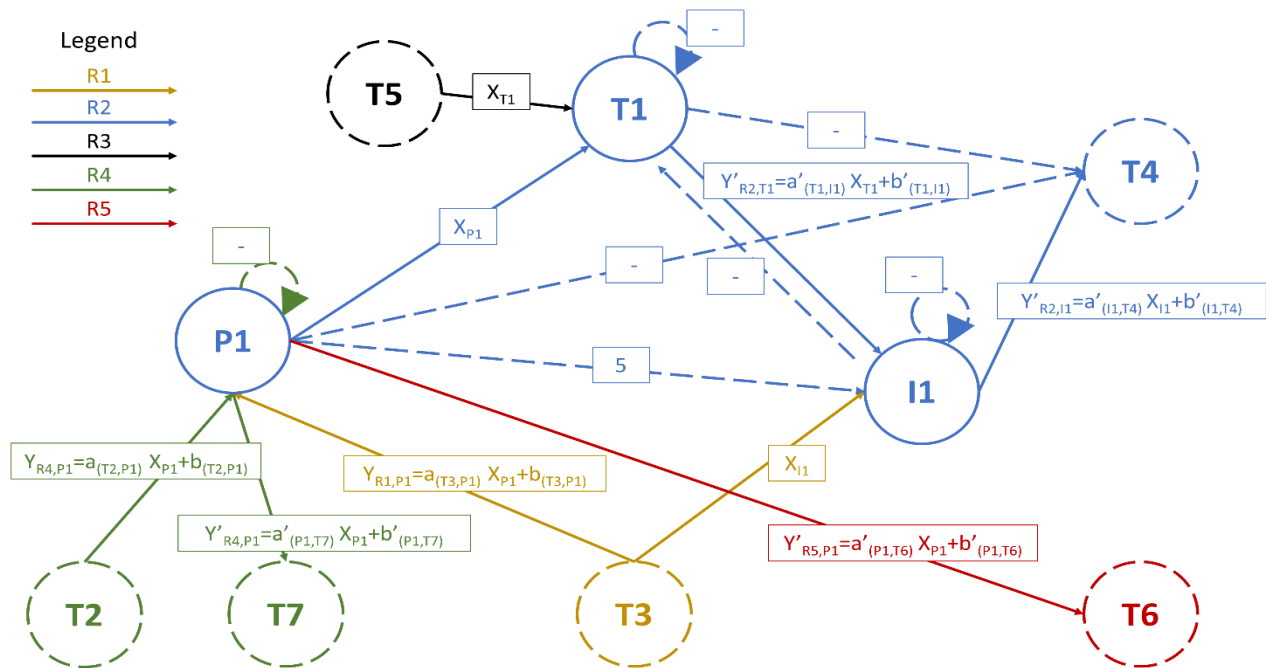

Figure 1. The RA MEIO graph for the three-activity system (P1, T1, and I1) and the five resources (T1, R2, R3, R4, and R5).

3.3. The exploitation of the MEIO method in the systemic design approach

The MEIO method exploitation within the SD approach helps to deal with complex systems characterised by multidisciplinary context, the involvement of many stakeholders in the design process, and the large number of alternative solutions identified to improve the current systems. Figure 2 shows the six-step SD approach, highlighting the phases in which the designers and the stakeholders can exploit the method.

The proposed approach introduces the MEIO formalisation method to enhance the robustness of the SD approach in phases 1 and 3: the *Holistic diagnosis* and the *System design*. Specifically, the method improves the data collection, conditioning and the processing activities by helping to consider all the involved resources (i.e., waste, by-products, and consumables beyond raw materials and finished products) to satisfy the material and energy balances in every activity through the three-table data structure and the compilation method. Therefore, the *linear model* (i.e., the initial systems) and the further production, transport, and inventory activities, which are introduced to create value from waste by constituting the several alternatives of the *systemic model*, are represented through the three MEIO tables.

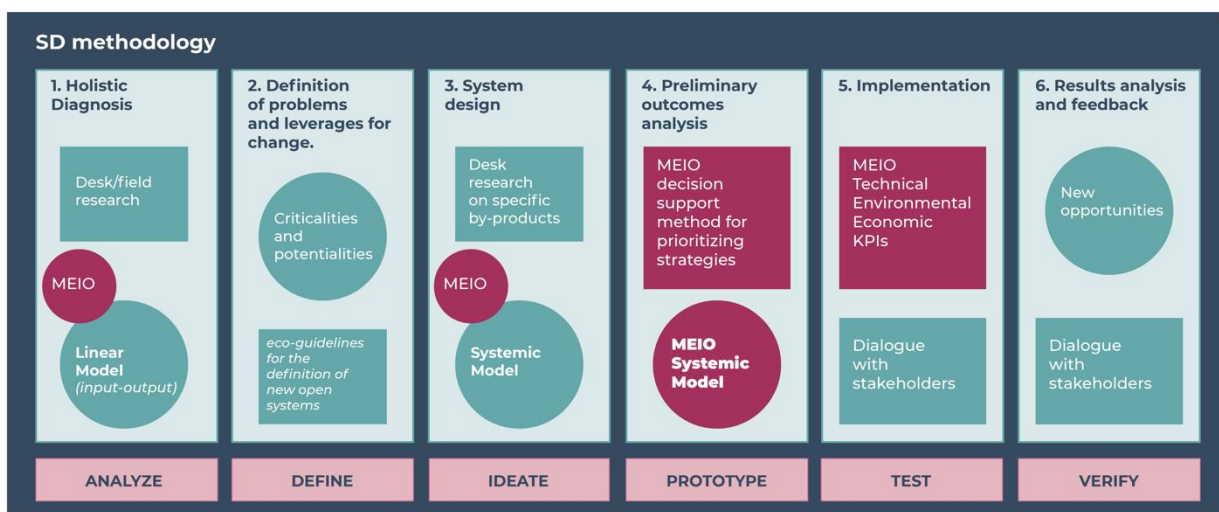

Figure 2. The six-step framework of the SD approach (proposed by Barbero, 2017; Battistoni et al., 2019; Gaiardo, 2016) with the integration of the MEIO method.

1 Both phases 4 and 5 of the SD approach, namely, the *Preliminary outcomes analysis* and the *Implementation*,
 2 involve extensive use of quantitative information represented by data arbitrarily chosen by the designer that
 3 could focus on some dimensions rather than others, for example, by privileging technical and economic KPIs
 4 and neglecting environmental ones. Moreover, the use of data in phase 4 has a different role than in phase
 5 5. In phase 4, quantitative information aims to support the designers in identifying the best set of alternatives
 6 according to the several dimensions. Conversely, in phase 5, the quantitative information aims to provide
 7 stakeholders with quantitative evidence of the potential benefits and weaknesses of each of the proposed
 8 alternatives of *systemic models*.

9 The proposed approach improves the effectiveness of phases 4 and 5 by exploiting the data collected and
 10 formalised by the MEIO method by developing a dashboard of performance indicators. The dashboard aims
 11 to reach the twofold goal of (i) defining general guidelines to objectively evaluate system performance and
 12 (ii) providing quantitative information to support designers and stakeholders in their respective roles. The
 13 KPIs can assess the technical, economic, and environmental performance of all the activities involved in both
 14 the *linear* and the *systemic models*. Furthermore, the *linear* and *systemic models*, modelled through the three
 15 MEIO tables or synthesised in the RA MEIO graph, can be hierarchically aggregated and disaggregated to
 16 provide the best detail level to each stakeholder. Hence, the KPIs can be applied to the single production,
 17 transport, and inventory activities or their aggregations to provide high-level quantitative information to
 18 stakeholders.

19 **3.3.1. Hierarchical data aggregation and disaggregation**

20
 21 The hierarchical approach allows to aggregate data formalised through the MEIO starting from the atomic
 22 entities, that is, the activities. The activity aggregation allows the designers to perform several kinds of
 23 analysis and highlight performance by considering the single activities or aggregating activities according to
 24 several criteria (e.g., involved resources, stakeholders who perform them).

25
 26 The activity aggregation modifies the MEIO tables by condensing the data of several activities in the
 27 aggregated one. The AP MEIO table is not affected by aggregation/disaggregation operations to maintain the
 28 entire information about the underlying processes. In the RA and RF MEIO tables, the underlying activities
 29 are substituted by the aggregated activities. The resource production and consumption in the RA and RF
 30 MEIO tables are adjusted differently if the quantities are produced and consumed only within the aggregated
 31 activity or purchased and sent out of the aggregated activity.

32
 33 In the first case, the RA and RF MEIO tables do not report the resources produced by underlying activities
 34 entirely consumed within the aggregated activity because they do not have effects outside of the aggregated
 35 activity. Conversely, the resources acquired from outside the aggregated activity by all the underlying
 36 activities are added together to define the input of the RA MEIO table. Similarly, all the resources produced
 37 by the underlying activities are added together and reduced by the quantities consumed internally to define
 38 the output quantity of the RA MEIO table. The new RF MEIO table sets new functions between the input and
 39 output of all involved resources because it must consider the resources produced and consumed within the
 40 new activity that do not produce effects in the rest of the system. Therefore, the activity
 41 aggregation/disaggregation is an alternative representation of the same system to highlight specific
 42 information for different stakeholders.

43
 44 Table 4 and Figure 3 show the RA MEIO graph and the new RA and RF MEIO tables on the left and the right,
 45 respectively, for the previous example of three activities and five resources, in which the activities P1, T1,
 46 and I1, performed by the same stakeholder, are aggregated in process activity A-P1.

47
 48 *Table 4. The aggregated RA and RF MEIO tables for the system of the previous example with five resources and three activities.*

	RA MEIO Table	RF MEIO table
Resources	A-P1	A-P1

R1	<i>input</i> _{R1,A-P1} /-	$Y_{R1,A-P1}=a_{(T3,A-P1)}X_{R3,A-P1}+b_{(T3,A-P1)}$;-
R2	-/ <i>output</i> _{R2,A-P1}	-; $Y'_{R2,A-P1}=a'_{(A-P1,T4)}X_{R3,A-P1}+b'_{(A-P1,T4)}$
R3	<i>input</i> _{R3,A-P1} /-	$X_{R3,A-P1}$;-
R4	<i>input</i> _{R4,A-P1} / <i>output</i> _{R4,A-P1}	$Y_{R4,A-P1}=a_{(T2,A-P1)}X_{R3,A-P1}+b_{(T2,A-P1)}$; $Y'_{R4,A-P1}=a'_{(A-P1,T7)}X_{R3,A-P1}+b'_{(A-P1,T7)}$
R5	-/ <i>output</i> _{R5,A-P1}	-; $Y'_{R5,A-P1}=a'_{(A-P1,T6)}X_{R3,A-P1}+b'_{(A-P1,T6)}$

1
2

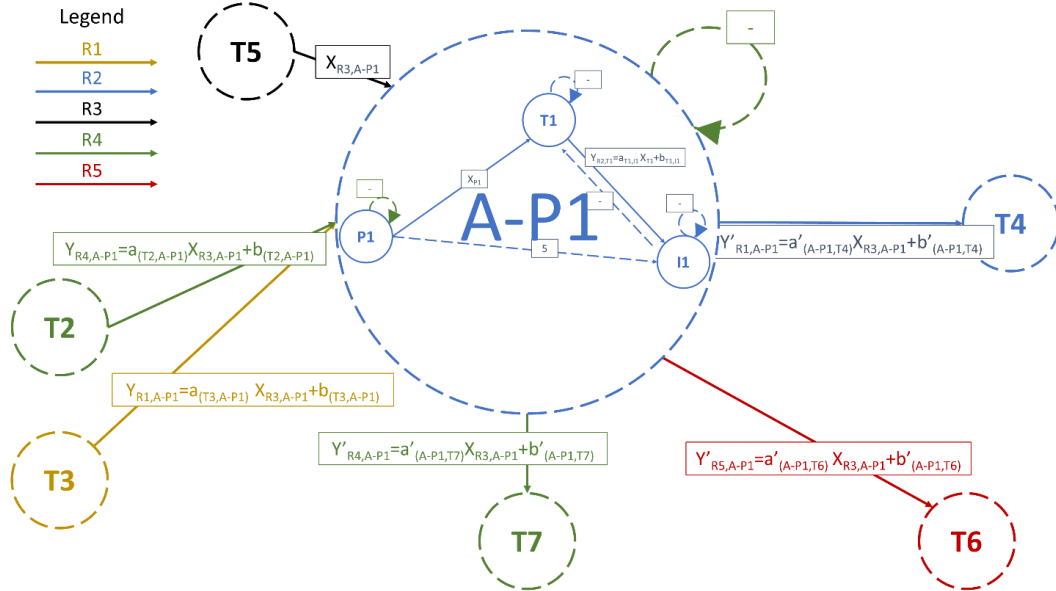

3
4

Figure 3. The RA MEIO graph for the system with activities aggregated by stakeholders.

3.3.2. KPI dashboard for the systemic design approach

5
6

The dashboard provides a set of indicators that assess single activities and sets of activities in terms of technical, economic, and environmental performance and provide insights useful for the systemic approach. Table 5 shows the set of resources used to define the KPIs.

7
8
9
10
11

Table 5. The sets of resources and activities used to define technical, economic, and environmental performance

Set	Description	Abbreviation
\mathcal{J}	\mathcal{J} is the set of all resources j involved in the system.	Total resources.
\mathcal{S}	\mathcal{S} is the set of all activities s involved in the system.	Total activities.
$\mathcal{E} \subset \mathcal{J}$	\mathcal{E} is the subset of all resources j that are energy vectors.	Energy vectors.
$\mathcal{R} \subset \mathcal{J}$	\mathcal{R} is the subset of all resources j that are materials.	Materials.
$\mathcal{I}_s \subset \mathcal{J}$	\mathcal{I}_s is the subset of all resources j input of activity s .	Input resources of s .
$\mathcal{O}_s \subset \mathcal{J}$	\mathcal{O}_s is the subset of all resources j output of activity s .	Output resources of s .
$\mathcal{S}_{ptw} \subset \mathcal{S}$	\mathcal{S}_{ptw} is the subset of the system \mathcal{S} involving activities p , t , and w .	Aggregated activity.
$\mathcal{W}_s \subset \mathcal{O}_s$	\mathcal{W}_s is the subset of all output resources j of s that are waste.	Waste.
$\mathcal{P}_s \subset \mathcal{S}$	\mathcal{P}_s is the subset of the system \mathcal{S} involving the production activities P .	Total production activities.
$\mathcal{T}_s \subset \mathcal{S}$	\mathcal{T}_s is the subset of the system \mathcal{S} involving the transport activities T .	Total transport activities.
$\mathcal{D}_s \subset \mathcal{S}$	\mathcal{D}_s is the subset of the system \mathcal{S} involving the inventory activities I .	Total inventory activities.

\mathcal{J}_s^v $\subset \mathcal{J}_s$	\mathcal{J}_s^v is the subset of virgin input resources j of activity s .	Virgin resources.
\mathcal{J}_s^r $\subset \mathcal{J}_s$	\mathcal{J}_s^r is the subset of input resources j of activity s recovered from other systems.	Recovered resources.

3.3.2.1. Technical performance

The following indicators measure the energy, raw material, and labour required by the activities that add value to defective products, waste, and scrap. Equation (1) represents the indicator for the raw materials embodied in waste for activity s (REW_s), in which the percentage of waste, that is, resources belonging to \mathcal{W}_s and the set \mathcal{R} of the raw materials, out of the total output material resources $\mathcal{O}_s \cap \mathcal{R}$ is multiplied by each raw material j in input decreased by the scrap, $\mathcal{J}_s \cap \mathcal{R}$:

$$REW_s = \frac{\sum_{j \in \mathcal{W}_s \cap \mathcal{R}} (Y_j)}{\sum_{j \in \mathcal{O}_s \cap \mathcal{R}} (Y_j)} \left(\sum_{j \in \mathcal{J}_s \cap \mathcal{R}} (Y_j) - \sum_{j \in \mathcal{J}_s \cap \mathcal{R} \cap \mathcal{W}_s} (Y_j) \right) \quad (1)$$

Equation (2) is the indicator to monitor the energy embodied in waste for activity s (EEW_s), that exploits the same ratio of Equation (1) multiplied by the energy vectors j in input decreased by the dissipated energy, that is, the energy vectors $j \in \mathcal{E} \cap \mathcal{W}_s$.

$$EEW_s = \frac{\sum_{j \in \mathcal{W}_s \cap \mathcal{R}} (Y_j)}{\sum_{j \in \mathcal{O}_s \cap \mathcal{R}} (Y_j)} \left(\sum_{j \in \mathcal{J}_s \cap \mathcal{E}} (Y_j) - \sum_{j \in \mathcal{J}_s \cap \mathcal{E} \cap \mathcal{W}_s} (Y_j) \right) \quad (2)$$

The last indicator (Equation (3)) measures the cost of resources, both energy vectors and raw materials, embodied in waste for activity s (CEW_s) through the market price p_j .

$$CEW_s = \frac{\sum_{j \in \mathcal{W}_s \cap \mathcal{R}} (Y_j)}{\sum_{j \in \mathcal{O}_s \cap \mathcal{R}} (Y_j)} \left(\sum_{j \in \mathcal{J}_s} (Y_j) p_j - \sum_{j \in \mathcal{J}_s \cap \mathcal{W}_s} (Y_j) p_j \right) \quad (3)$$

3.3.2.2. Economic performance

The activity economic profitability (AEP_s) indicator measures the net profit generated through activity s . In Equation (4), the AEP_s considers the economic savings generated by using resource j as a raw material rather than waste, specifically, the savings of avoided disposal costs (s_j^d) and the minor cost compared to raw material (s_j^v), the revenues evaluated through the market prices (p_j) of the activity outputs, the resource purchasing costs, and the operating costs such as the labour cost l_s and the disposal costs (d_j) of the inputs resources.

$$AEP_s = \sum_{j \in \mathcal{J}_s} \left((s_j^d + s_j^v - p_j) Y_j \right) - l_s X_s + \sum_{j \in \mathcal{O}_s} \left((p_j - d_j) Y_j \right) \quad (4)$$

Equation (5) shows the economic profitability (SEM_s) indicator for subsystem S ; it measures the economic profitability of the nodes belonging to S by summing their individual AEPi.

$$SEM_s = \sum_{s \in S} (AEP_s) \quad (5)$$

Equation (6) indicates the percentage of costs of the added value activities ($PAVA_s$) of system S , that is, the set of production processes \mathcal{P}_s , compared to the costs of all the activities.

$$PAVA_s = \frac{\sum_{s \in \mathcal{P}_s} \left(\sum_{j \in \mathcal{J}_s} \left((p_j) Y_j \right) + l_s X_s + \sum_{j \in \mathcal{O}_s} \left((d_j) Y_j \right) \right)}{\sum_{s \in S} \left(\sum_{j \in \mathcal{J}_s} \left((p_j) Y_j \right) + l_s X_s + \sum_{j \in \mathcal{O}_s} \left((d_j) Y_j \right) \right)} \quad (6)$$

3.3.2.3. Environmental performance

Equation (6) measures the exploited quantity of waste and by-products of other systems compared to the total quantity used to input raw materials. Hence, for each activity s , the percentage of recovered resources

1 (PRR_s) out of all the resources used as input. The indicator reported in Equation (7) measures the quantity of
 2 energy recovered from other systems (PER_s) out of the total used energy. The indicator reported in Equation
 3 (8) assesses the percentage of resources recovered from other systems(ARR_s) by evaluating the average of
 4 indicators in Equations (6) and (7).

$$PRR_s = \frac{\sum_{j \in J_s^r \cap \mathcal{R}}(Y_j)}{\sum_{j \in J_s \cap \mathcal{R}}(Y_j)} \quad (6)$$

$$PER_s = \frac{\sum_{j \in J_s^r \cap \mathcal{E}}(Y_j)}{\sum_{j \in J_s \cap \mathcal{E}}(Y_j)} \quad (7)$$

$$ARR_s = \frac{PRR_s + PER_s}{2} \quad (8)$$

5 The indicator in Equation (9) measures the quantity of energy required for one unit of valuable output of
 6 activity s (EVO_s). Equation (10) indicates the ratio between the waste of other systems used as raw material
 7 (RW_s) and the production of new waste from the process.

$$EVO_s = \frac{\sum_{j \in J_s \cap \mathcal{E}}(Y_j)}{\sum_{j \in \mathcal{O}_s / \mathcal{W} \cap \mathcal{E}_s}(Y_j)} \quad (9)$$

$$RW_s = \frac{\sum_{j \in J_s^r \cap \mathcal{R}}(Y_j)}{\sum_{j \in \mathcal{W}_s \cap \mathcal{R}}(Y_j)} \quad (10)$$

8

9 3.3.2.4. Systemic information

10

11 This set of information is not derived from the MEIO data structure, and it provides the systemic designer
 12 information regarding the geographical context and the specific industrial fields. Table 6 collects all the
 13 systemic information. The reference market (TM_j) is the market to which the resource j belongs, and it is
 14 crucial to determine whether the proposed *systemic model*, that is, the set of activities \mathcal{S} , enriches or
 15 impoverishes the initial sector of the produced (OUT_j) and absorbed (IN_j) quantities. It is crucial for each
 16 activity s the number of other activities (NFA_s) fed through its finished products, reusable waste, and by-
 17 products, and the number of local fed activities ($NLFA_s$), that is, those activities that can be performed in the
 18 local community creating jobs and increasing the quantities of resources produced and absorbed by the
 19 region.

20

21 *Table 6. Systemic parameters that characterise the activities of the system.*

Characteristic	Definition
TM_j	The market to which the resource j belongs.
OUT_j	The total quantity of the resource j produced by the set of activities \mathcal{S} .
IN_j	The total quantity of the resource j absorbed by the set of activities \mathcal{S} .
NFA_s	The number of activities fed through the resources produced by activity s .
$NLFA_s$	The number of local activities fed through the resources produced by activity s .
$NLPA_s$	The number of local activities that feed the activity s .

22

23 4. Case study: the InnovaEcoFood project

24

25 The proposed approach does not focus on a specific industrial field. However, it is particularly suitable for
 26 the design and development of production networks in which mutual trust among stakeholders must be
 27 developed, and innovation is crucial at the technological, business model, and operational levels, such as in
 28 industrial symbiosis. The food and drink industry has some characteristics capable of highlighting the
 29 strengths of the SD framework extended with the MEIO formalisation method, such as its strong relationship
 30 with the local tradition and know-how, the coordination of many stakeholders, and the impact on the local
 31 communities.

32

1 InnovaEcoFood project investigates the exploitation of marc and rice hulls that are by-products of wine and
 2 rice production chains. Fiore et al. (2020) applied the original SD framework to the marc and rice hull systems
 3 to identify a *systemic model* able to exploit these by-products by avoiding the downcycling in animal food
 4 and barn products. Several possible *systemic models*, that is, alternatives creating *open systems* exploiting
 5 the by-products mentioned above, have been identified involving several industrial fields and different
 6 stakeholders. The final *systemic model* proposed by the InnovaEcoFood project studied the production of
 7 marc flour, rice hull flour, and rice hull butter and their use in baked food products.

8
 9 The approach in this paper is implemented in the final *systemic model* of the InnovaEcoFood project to reach
 10 the threefold goal of:

- 11 • showing how to implement the MEIO formalisation method to collect and formalise data to
 12 represent the systems;
- 13 • introducing the managerial insights stemming from the dashboard of techno-economic-
 14 environmental KPIs and systemic information;
- 15 • showing the performance assessment, which can be extended at different aggregation levels of the
 16 system activities to support designers' and stakeholders' analyses.

17 The MEIO tables and the RA MEIO graph should also include the activities of the *linear model*, such as grape
 18 and rice harvesting, their preliminary treatments, and the other alternatives of *systemic models* identified in
 19 Fiore et al. 2020. The proposed case study focuses only on the *systemic model*, even though the methodology
 20 includes the *linear model*, to reduce redundancy and complexity while increasing understandability. Figure
 21 A1 in Appendix A shows the entire InnovaEcoFood project.

22
 23 Figure 4 shows the stakeholders of InnovaEcoFood; in particular, Agrindustria is involved in the mechanical
 24 transformation, Exenia Group in chemical transformation, and Quasani – Fattoria della Mandorla produces
 25 the baked products. Table 7 highlights the involved resources and their market price, while Table 8 presents
 26 the eleven production activities and the produced and absorbed resources. *Supercritical CO₂ extraction* (P8
 27 in Table 8) employs 60 kg of CO₂ in each extraction; 8.33% becomes a waste, while the remaining 91.66% is
 28 recovered for the subsequent extraction.
 29

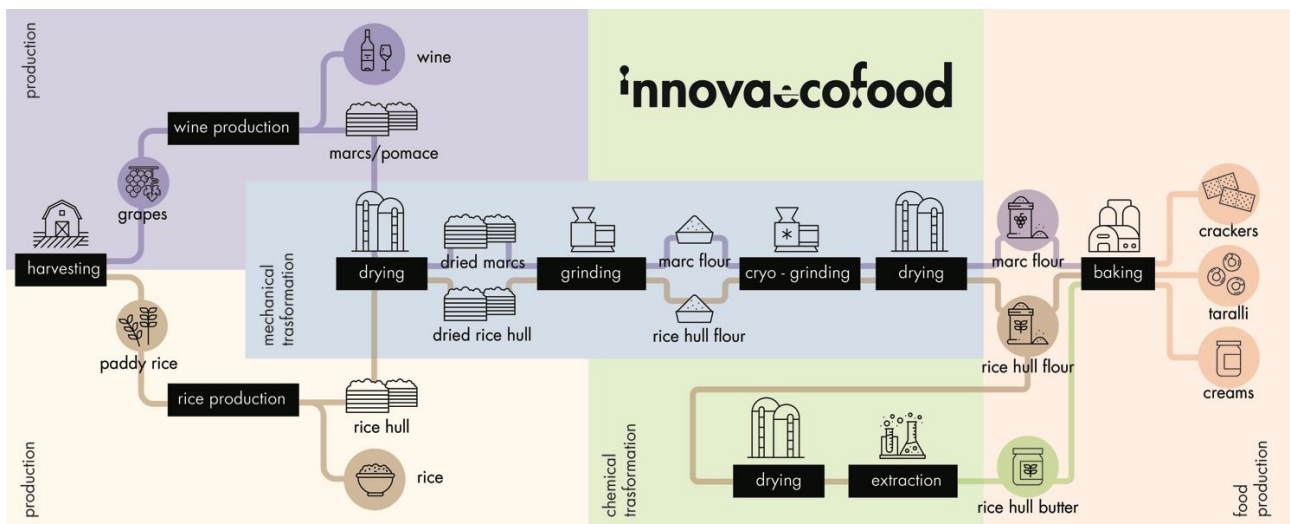

30 Figure 4. The stakeholders involved in the InnovaEcoFood project: rice and wine producers, marc and rice hull flour producer, rice
 hull butter producer, and the producer of baked products.

31 Table 7. Prices of finished products and resources in 2018

Resource ID	Resource	Price	Resource ID	Resource	Price
R1	Taralli (€/kg)	10.00	R9	Dried marc (€/kg)	0.06
R2	Cracker (€/kg)	14.50	R10	Marc flour 10.00 mm (€/kg)	0.10
R3	Cream (€/kg)	48.00	R11	Marc flour 0.50 mm (€/kg)	0.15

R4	Almond (€/kg)	12.00	R12	Marc flour 0.50 mm FOOD (€/kg)	2.00
R5	Power (€/kWh)	0.05	R13	Rice hull (€/kg)	0.70
R6	Water (€/kg)	0.01	R14	Rice hull flour 10.00 mm (€/kg)	1.30
R7	Heat (€/kWh)	0.01	R15	Rice hull flour 0.50 mm FOOD (€/kg)	1.70
R8	Marc (€/kg)	0.01	R16	Rice hull butter (€/kg)	250.00

1

2 *Table 8. The eleven production activities involve 16 resources to produce marc and rice hull flours, rice hull butter and baked*
3 *products.*

Stakeholder		Agrindustria						Exenia Group		Quasani – Fattoria della Mandorla		
Main finished product		Marc flour				Rice hull flour		Rice hull butter		Crackers	Taralli	Cream
Resource ID	Unit	P1	P2	P3	P4	P5	P6	P7	P8	P9	P10	P11
		Drying	Crushing	Cryo-grinding	Bacterial load reduction and final drying	Cryo-grinding	Bacterial load reduction and final drying	Drying	Super-critical CO ₂ extraction	Production of Crakers	Production of Taralli	Production of Cream
R1	Kg	-	-	-	-	-	-	-	-	-	+1	-
R2	Kg	-	-	-	-	-	-	-	-	+1	-	-
R3	Kg	-	-	-	-	-	-	-	-	-	-	+1
R4	Kg	-	-	-	-	-	-	-	-	-	-	-0.3
R5	kWh	-5	-1	-10	-10	-10	-10	-30	-6.5	-0.12	-0.9	-0.27
R6	Kg	-	-	-	-7	-	-7	-	-	-3	-2	-3
R7	kWh	-100	-	-	-100	-	-100	-	-1.84	-	-	-
R8	Kg	-100	-	-	-	-	-	-	-	-	-	-
R9	Kg	+47	-100	-	-	-	-	-	-	-	-	-
R10	Kg	-	+99.5	-100	-	-	-	-	-	-	-	-
R11	Kg	-	-	+99	-100	-	-	-	-	-	-	-
R12	Kg	-	-	-	+100	-	-	-	-	-0.277	-0.277	-0.277
R13	Kg	-	-	-	-	-100	-	-1	-	-	-	-
R14	Kg	-	-	-	-	+99	-100	+0.987	-1	-	-	-
R15	Kg	-	-	-	-	-	+100	-	-	-0.277	-0.277	-0.277
R16	Kg	-	-	-	-	-	-	-	+0.002	-0.277	-0.277	-0.277
Operating cost	€	-	-	-	-	-	-	9	-	-	-	-

4

5 **4.1. Method application**

6

7 The performance and resource efficiency analysis of the whole production chain neglects financial and labour
8 costs because they depend on the production chain design for market competition, which goes beyond the
9 technical exploration set by the project.

10

11 *The Resource-Activity MEIO table*

12

13 The construction of the RA MEIO tables (Tables A1 and A2 in Appendix A) ensures the identification of all the
14 resources involved in each activity of the current production systems by identifying the crucial points. Before
15 the MEIO application, the stakeholders provided the power and heat required for activities from P1 to P11,
16 but they did not know their actual use because the machines do not detect dissipated heat and power used
17 for support and monitoring tasks. Also, the humidity content of raw materials was initially neglected,
18 although it affects the volume and the weight of resources transported and stored. The RA MEIO table
19 required making assumptions for the missing information bringing out the initially neglected resources.

20

21 The RA MEIO tables (Tables A1 and A2 in Appendix A) highlight the unexploited resources such as water in
22 the raw marc and rice hull (Table A1 shows 53% of unused water for marc in process P1, while Table A2 shows
23 1.3% for rice hull in P7). Moreover, Table A1 highlights the valuable material losses such as marc flour in P2
24 and P3 (0.5% and 1%, respectively) and the rice hull flour in P5 (1%), while Table A2 reports the loss of CO₂
25 in P8 (5 kgs out of the initial 60 kgs) that also is a climate-altering gas.

26

27 *The Activity-Parameter MEIO table*

28

1 The AP MEIO table collects information about involved processes to summarise the data provided by the
2 stakeholders and track their changes. Tables A3 and A4 in Appendix A show data provided by the stakeholders
3 for the 11 production activities. The row *ID resource involved* shows that the same machines used in P3 and
4 P4 are used in P5 and P6, respectively. The distance matrix in the bottom part of the AP MEIO tables shows
5 that all the activities are considered in the same area; thus, no transport and inventory activities have been
6 included in the analysis.

7 8 *The Resource-Function MEIO table.*

9
10 Tables A5 and A6 in Appendix A are the RF MEIO tables showing that, in the InnovaEcoFood project, the
11 activity production and absorption of the resource flows are not affected by the production rate; that is, no
12 scale factors are included in the analysis except for CO₂. The supercritical CO₂ extraction process (P8 in Table
13 A6) uses a quantity of CO₂ (60 kg) independent of the raw materials introduced. A large part of CO₂ employed
14 is recovered (55 kg) while the remaining part of CO₂ is emitted into the atmosphere (5 kg).

15 16 *The RA MEIO graph.*

17
18 To define the arc weights (dependent and independent variables of all activities) is necessary to fix the
19 independent variables X_i of all the activities by ensuring the material and energy balance in each activity.
20 Therefore, starting to fix the independent variables of the activities that produce the finished products (P9,
21 P10, and P11), the method goes on backwardly by fixing the independent variables of the previous nodes to
22 produce enough raw materials.

23
24 The independent variable X_{P9} , X_{P10} , and X_{P11} (i.e., the produced amount of *crackers*, *taralli*, and *almond cream*,
25 respectively) are set to 1 kg; thus, the case study and the following performance analysis is developed on the
26 production of 1 kg of each baked product. The activity P8 that produces rice hull butter must produce $0.01 +$
27 $0.01 + 0.1$ kg ($a'_{(P8,P9)}$, $a'_{(P8,P10)}$, and $a'_{(P8,P11)}$, respectively); therefore, in P8, the *rice hull butter* dependent
28 variable Y is set to 0.12, forcing the independent variable X_{P8} to be 6 (because $Y = 0.02 * X_{P8} = 0.12$), and it is
29 used to derive the other production input and output.

30
31 Figure 5 shows the RA MEIO graph for the proposed system characterised by 11 production activities (solid
32 circles in Figure 5). Figure 5a highlights the arc weights (in grey) for the finished products of the activities and
33 the scrap flows. For example, from P9, P10, and P11, the outgoing arcs indicate the production of 1 kg of
34 crackers, 1 kg of taralli, and 1 kg of almond cream, respectively, and the production of 2.564 kg, 1.564 kg,
35 and 2.954 kg of wastewater, with a high content of ingredients, used to clean the machines, respectively.
36 Conversely, the incoming arcs in P9 indicate the required 0.277 kg of marc flour, 0.277 kg of rice hull flour,
37 and 0.01 kg of rice hull butter. The arcs (P8,T10) and (T10,P8) show the need for CO₂ and the partial recovery
38 for the next production. Figure 5b shows the absorption and production of water (in blue arcs), and the sum
39 of all the incoming grey and blue arcs is equal to the sum of all the grey and blue arcs outgoing in each node,
40 representing the material balance. Figures 5c and 5d show the absorption of heat and power, respectively,
41 which neglects the dissipated energy. Figure 4e shows the entire RA MEIO graph.

42
43 Through the backward fix of the independent variables, it is possible to observe that the productions of 1 kg
44 of each of the three finished products require approximately 1.8 kg of fresh marc, 7 kg of rice hull (the arcs
45 outgoing from T0 in Figure 5a), 8.116 kg of water (the arcs outgoing from T11 in Figure 5b), 14.502 kWh of
46 heat (arcs outgoing from T8 in Figure 5c), and 223.122 kWh of power (arcs outgoing from T9 in Figure 5d).
47 However, each activity contributes differently to resource flow consumption and waste production. Thus, a
48 set of KPIs has been developed by exploiting the RA MEIO graph to support the decision-maker in assessing
49 the performance of the single activities and the entire system.

50 51 **4.2. Performance analysis**

52

- 1 Table 9 shows the scores obtained by the eleven production activities in the eleven KPIs evaluated by
- 2 exploiting the RA MEIO graph and the three systemic parameters referred to the activities. Table 10 presents
- 3 the three systemic parameters that refer to the resources involved in the project rather than its activities.

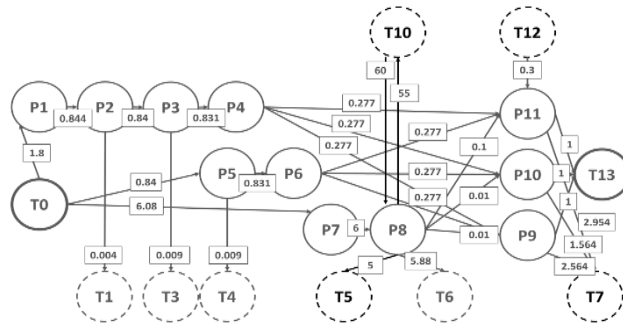

a) The RA MEIO graph showing the arcs of finished products: pomace and rice husk flours, rice husk butter, crackers, taralli, and almond cream.

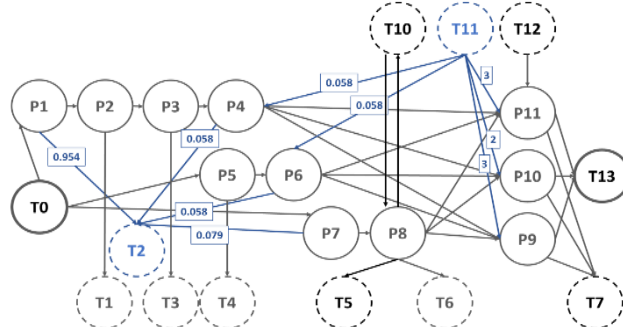

b) The RA MEIO graph showing the arcs of freshwater and wastewater.

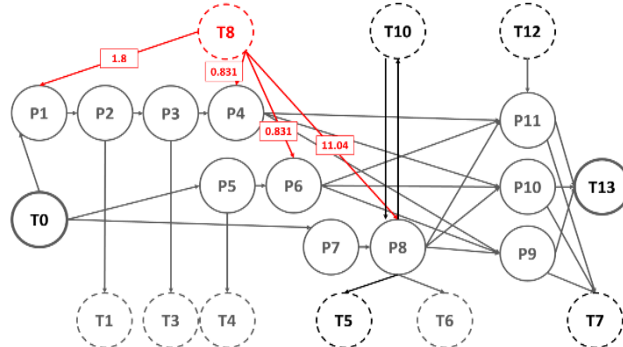

c) The RA MEIO graph showing the arcs of heat.

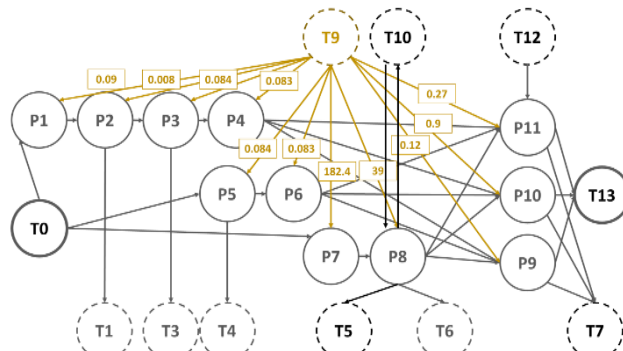

d) The RA MEIO graph showing the arcs of power.

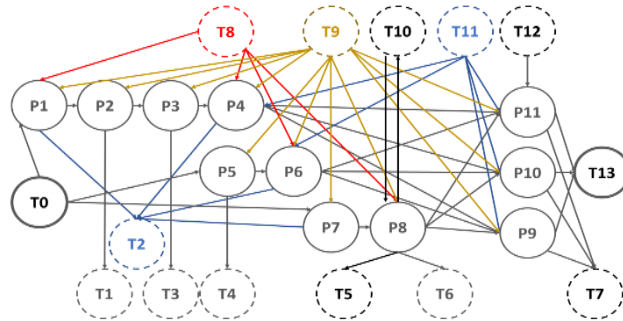

e) The complete RA MEIO graph.

1 Performance analysis follows the same principles of the proposed methodology; thus, the main goal is to
 2 support designers and stakeholders in developing *open systems*. Therefore, the performance assessment of
 3 production activities goes beyond identifying the best performing technologies. It also aims to shed light on
 4 those activities that represent an opportunity to engage other stakeholders capable of providing waste to
 5 substitute virgin raw materials and exploit the unused output of the activity.
 6

7 The technical KPIs in Table 9 identify the crucial activities from the production efficiency aspect. The
 8 production of rice hull butter (P8) generates a proportionally large amount of wasted resources (large
 9 REW_s) because, currently, the exhaust rice hull is not employed. Activities P7 and P8 require significant
 10 energy compared with the amount of waste produced (large EEW_s), suggesting finding sources of green
 11 energy to reduce environmental impacts significantly and identify uses for the unexploited resources. Large
 12 CEW_s identifies those activities sensitive to production waste; for example, production waste of activities
 13 from P9 to P11 generates relevant costs because they involve rice hull butter, a high-valuable raw material.
 14

15 The economic KPIs highlight the value created by each activity (AEP_s) and the costs absorbed by the non-
 16 value-added activities ($PAVA_s$). The rice hull butter production has a more significant profit because it is
 17 considered particularly healthy. Consequently, the cream, which uses a large quantity of rice hull butter, has
 18 a larger value than crackers and taralli. The production of marc and rice hull flours for the food sector has
 19 aggregate positive profitability; however, ($PAVA_s$) highlights that the InnovaEcoFood project does not
 20 consider non-value-added activities such as transports and inventories. SEM_s highlights the profitability of
 21 several subsystems, namely, the activities involved in the production of marc flour, those producing rice hull
 22 flour, the rice hull butter production, and the three baked products.
 23

24 Environmental KPIs focus on efficient use of resources; they can be improved by adopting 6Rs strategies,
 25 exploiting waste as raw materials, and recovering energy from other systems. The proposed systemic model
 26 is mainly fed by waste used as raw materials (PRR_s close to 100%), and water is the only resource that is not
 27 recovered from any other system. Conversely, no one source of energy is renewable, nor it is recovered from
 28 excesses of other systems (ERR_s close to 0%). The RW_s shows the waste absorption capacity out of the new
 29 produced waste, highlighting the improvement in recovering raw materials and energy; for example, the
 30 agricultural activities involving grapes and rice treatments (not shown in our case study) would have a higher
 31 score because marc and rice hull become finished products rather than waste.
 32

33 The systemic parameters in Table 9 show the centrality of the activities regarding their interconnections
 34 within the system (NFAs) and out of the system (dashed nodes in RA MEIO graph in Figure 5 representing
 35 resource providers NLPAs and output users NLFAs). Activities P4, P6, and P8, that is, flours and rice hull
 36 production, are crucial for the proposed systemic model (large NFAs), P8 provides many resources outside of
 37 the system (largest NLFAs), and P4, P6, and P8 are the most dependent from the resources coming from
 38 outside (largest NLPAs), that is, foster the production of other economic activities of the local community by
 39 absorbing their products.
 40

41 *Table 9. The scores of the eleven production activities in eleven KPIs and the three out of six systemic parameters referred to the*
 42 *activities.*

	Acrr.	Unit	P1	P2	P3	P4	P5	P6	P7	P8	P9	P10	P11
Technical KPIs													
Raw material embodied in waste	REW_s	Kg	0,95	0,00	0,01	0,06	0,01	0,06	0,08	10,88	2,56	1,56	2,95
Energy embodied in waste	EEW_s	kWh	1,00	0,00	0,00	0,06	0,00	0,06	2,37	8,24	0,09	0,55	0,22
Cost of resources embodied in waste	CEW_s	€	0,02	0,00	0,00	0,11	0,01	0,09	0,12	1,63	2,56	2,19	22,17
Economic KPIs													

Activity economic profitability	AEP_s	€	0,01	0,03	0,04	1,52	0,49	0,32	-9,18	23,74	10,94	6,41	18,33
Subsystem economic profitability	SEM_s	€		1.6				0.81		14.56	10.94	6.41	18.33
Percentage of costs of added value activities in a subsystem	$PAVA_s$	%		100%				100%		100%	100%	100%	100%
Environmental KPIs													
Percentage of raw materials recovered from waste out of all raw materials involved	PRR_s	%	100%	100%	100%	93%	100%	93%	100%	55%	16%	22%	15%
Percentage of energy recovered from waste out of all energy used	PER_s	%	0%	0%	0%	0%	0%	0%	0%	0%	0%	0%	0%
Average resources recovered by waste	ARR_s	n.a.	50%	50%	50%	47%	50%	47%	50%	27%	8%	11%	7%
Energy embedded in finished products	EVO_s	kWh/kg	2,24	0,01	0,10	1,10	0,10	1,10	30,40	417,0	0,12	0,90	0,27
Waste absorbed out of waste produced	RW_s	n.a.	1,89	211,0	93,33	14,33	93,33	14,33	76,96	0,55	0,22	0,36	0,22
Systemic information													
The number of activities of the system fed through the activity s	NFA_s	n.a.	1	1	1	3	1	3	1	4	1	1	1
The number of activities out of the system fed through the activity s	$NLFA_s$	n.a.	1	1	1	1	1	1	1	2	1	1	1
The number of activities out of the system feeding the current one	$NLPA_s$	n.a.	2	1	1	3	1	3	1	3	2	2	2

1

2

Systemic parameters in Table 10 show that all the involved resources maintain the food-grade label and show the production and consumption of resources in this case study, which is set on 1 kg of each baked product.

3

4

5

Table 10. Three out of six systemic information referred to the resources.

Systemic information	The market to which the resources belong	Total produced quantity of resource j	Total absorbed quantity of resource j	Systemic information	The market to which the resources belong	Total produced quantity of resource j	Total absorbed quantity of resource j
Acr	TM_j	OUT_j	IN_j	Acr	TM_j	OUT_j	IN_j
Unit	n.a.	Kg or kWh	Kg or kWh	Unit	n.a.	Kg or kWh	Kg or kWh
R1	Food industry	1	-	R9	Food industry	0.844	0.844
R2	Food industry	1	-	R10	Food industry	0.844	0.84
R3	Food industry	1	-	R11	Food industry	0.84	0.831
R4	Food industry	-	-	R12	Food industry	0.831	0.831
R5	Multi-utility	-	223.122	R13	Food industry	-	6.92
R6	Multi-utility	1.149	8.116	R14	Food industry	0.84	0.831
R7	Multi-utility	-	14.502	R15	Food industry	0.831	0.831
R8	Food industry	-	1.8	R16	Food industry	0.12	0.12

6

7

5. Discussion

This study proposes the combined use of the SD approach and MEIO formalisation method to support all the involved stakeholders during the six phases required to establish new production networks (e.g., industrial symbiotic relationships and eco-industrial parks): (1) preliminary assessment, (2) engage business, (3) find synergy opportunities, (4) determine feasibility, (5) implement transactions, and (6) documentation (Yeo et al., 2019). The proposed approach represents a framework to promote the stakeholders' engagement and the cooperation between decision-makers, designers, technicians, engineers, and entrepreneurs of all the involved public and private entities.

The proposed approach evaluates techno-economic-environmental data related to the activities analysed in different production network design and establishment phases. This approach ensures coherence and consistency in all the KPIs provided to each stakeholder, thus avoiding partial and discordant information. The flexibility and adaptability of the proposed approach and its focus on bottom-up development of production networks contribute to overcoming the lack of quantitative approaches for supporting self-organised networks, which are considered preferable because of their significant potential diffusion (Lybæk, Christensen, & Thomsen, 2021). The same KPIs can be assessed for single activities and clusters of network activities to provide each stakeholder with the most pertinent information. For example, designers would be interested in single activities in order to analyse input and output resources and their match; entrepreneurs would focus on the KPIs of their companies by aggregating sets of activities. Production engineers would consider the activity production rates to optimise the overall production. In contrast, public decision-makers would consider the network global KPIs and their influences on the local economy, environment, and community.

The MEIO method introduces the techno-economic-environmental parameters of the production processes, both internal and external to the network, in all the design phases because available technology, product demands, raw material prices, and other external factors (e.g., landfill tax) can have hindering and fostering effects on the network establishment (Yap & Devlin, 2017). Moreover, the RF MEIO table allows dynamic analyses to investigate the changes in KPIs in each phase in which some crucial factors regarding the production systems change (e.g., production rates, waste procurement, and finished product demands).

Dynamic analyses help the decision-maker, during the system design phase, to choose the best alternative solution also according to the values of the aforementioned crucial factors. Dynamic analyses enable scenario and what-if analyses to evaluate robustness and resilience and investigate the relationships with the local economy through the systemic design KPIs. Increasing the connections with other local networks and relevance to the local economy can be drivers to foster the production network development (Neves et al., 2019).

The development of new products and businesses is relevant for the economic sustainability of production networks jointly based on industrial symbiosis and supply chains (Castiglione & Alfieri, 2019; Sellitto et al., 2021). Therefore, the SD framework aims to support many stakeholders in developing businesses based on new production systems by intertwining the resource flows of the original ones. The quantitative formalisation of the current and the new systems helps to make consistent the data provided by the stakeholders by making the design process more structured and avoiding frequent changes in the system representation. Furthermore, using the MEIO formalisation method enlarges the number of tools the decision-maker can use to assess system performance and provide quantitative evidence to the stakeholders (e.g., facilitating LCA use). Furthermore, the quantitative evidence supports companies to discover easy-to-achieve competitive advantages and policy-makers to focus only on those connections that require a public incentive to be established to realise an economic and environmental gain (Scott Victor Valentine, 2016).

The new systems generate new waste and by-products, which may be easier or more difficult to exploit than the original ones. Whether a waste is an opportunity or a risk depends on the capabilities and the know-how of the local communities to exploit it. The proposed dashboard of KPIs allows the identification and

1 quantification of waste produced by each proposed solution; thus, it supports the SD approach in designing
2 sustainable systems for the local communities in which they are located.

3
4 The proposed approach is mainly suitable for designing and establishing production networks involving
5 industrial symbiosis and based on cooperative approaches among stakeholders in a bottom-up fashion. For
6 example, it is useful for self-organising networks and “build and recruit” models (Chertow & Ehrenfeld, 2012)
7 in which the proposed approach fosters cooperation. It reduces the “mental distance” and increases the trust
8 among all the partners, which are two of the main issues for whose the recent literature about barriers and
9 drivers to the establishment of industrial symbiosis relationships identified a lack of tools, methods and
10 discussions (Yeo et al., 2019). Differently from top-down approaches (e.g., network optimisation algorithms
11 and models where input and output resources are already planned), the proposed approach fosters the
12 stakeholders’ engagement in all the design and development phases.

13 14 **6. Conclusion**

15
16 This paper proposes an approach based on a Systemic Design (SD) framework and a novel hierarchical version
17 of the Multi-layer Enterprise Input-Output formalisation method (MEIO) to support the design and the
18 establishment of production networks based on industrial symbiosis and stakeholders’ cooperation and
19 involvement since the design phase. The approach supports designers in the data collection and formalisation
20 activities by improving system formalisation, data consistency, and coherence. The combination with the
21 MEIO method allows the quantitative comparison of techno-economic-environmental performance to select
22 the most promising activities to design the network. Furthermore, the MEIO method has been improved to
23 allow the aggregation and disaggregation of activities to provide each stakeholder with information at the
24 proper level of detail. All the proposed KPIs, useful for the phases leading to the production network
25 establishment, are evaluated on the specific set of information suitable for each stakeholder but based on
26 the same shared platform to increase data consistency and coherence. Furthermore, the proposed approach
27 supports designers in their mediation role (Celaschi, Formia & Lupo, 2013) to overcome the physical and
28 “mental distance” between stakeholders by setting up a dialogue.

29
30 The approach does not explicitly consider the social dimension since it focuses on techno-economic-
31 environmental and systemic design dimensions. However, the MEIO architecture facilitates the adoption of
32 other methods such as Social Life Cycle Analysis through consistently aggregated information about activities.
33 Furthermore, the dashboard of KPIs mainly focuses on supporting stakeholders during the design and
34 development phases, and its future improvements might include further financial, economic, environmental,
35 and social KPIs such as job creation.

36 Future research can investigate the introduction of other quantitative tools such as algorithms and heuristics
37 for network optimisation to support the proposed approach by enriching the comparison of the found
38 alternatives for network creation. Furthermore, the proposed approach could extend the analyses to the
39 stakeholders’ behaviours to avoid opportunistic effects through game theory approaches and multi-agent
40 systems. Finally, introducing one or more commitment keeping mechanisms (Castiglione & Alfieri, 2020),
41 which are devoted to ensuring and supporting the stakeholders’ engagement also after the production
42 network establishment, can help the network design phases.

43
44 **Author Contributions:** each author contributed equally to the writing of the paper; however, C.C. mainly
45 focused on the mathematical modelling, the integration of the MEIO formalisation method, the performance
46 assessment, and the managerial and industrial aspects of the production systems based on industrial
47 symbiosis. E.F. mainly dealt with the theoretical framework of the SD in the literature review, methodology,
48 the InnovaEcoFood project, and the discussion and conclusion sections.

49
50 **Acknowledgements:** authors acknowledge all the partners of the InnovaEcoFood project, namely, the
51 companies involved that contributed with their data to this study, the collaborators in the field of SD (Paolo

1 Tamborrini, Silvia Barbero, and Amina Pereno), and Debora Fino, Tonia Tommasi, Silvia Fraterrigo from the
2 Department of Applied Science and Technology (DISAT).

3

4 **7. References**

5

6 Abbott, R., Hadžikadić, M., 2017. Complex adaptive systems, systems thinking, and agent-based
7 modeling. In Hadžikadić, M., Avdaković, S. (Eds.), *Advanced technologies, systems, and applications* (pp. 1-
8 8). Cham, Switzerland: Springer.

9 Albino, V., Fraccascia, L. & Giannoccaro, I., 2016. Exploring the role of contracts to support the emergence
10 of self-organised industrial symbiosis networks: an agent-based simulation study. *Journal of Cleaner*
11 *Production*, 112, pp.4353-4366.

12 Allais, R., Reyes, T. & Roucoules, L., 2015. Inclusion of territorial resources in the product development
13 process. *Journal of cleaner production*, 94, pp.187-197.

14 Barbero, S., 2015. Systemic Design for Food Sustainability Interpretation of real cases and reflection on
15 theories. *Proceedings of Relating Systems Thinking and Design (RSD4) Symposium*, 1-3 September, 2015,
16 Banff, Canada.

17 Barbero, S., 2017. *Systemic Design Method Guide for Policymaking: A Circular Europe on the Way;*
18 *Allemandi: Torino, Italy; Volume 1, ISBN 978-88-422-2444-0.*

19 Battistoni, C.; Nohra, C.G., 2017. The Retrace Holistic Diagnosis. In *Systemic Design Method Guide for*
20 *Policymaking: A Circular Europe on the Way; Barbero, S., Ed.; Allemandi: Torino, Italy; Volume 1, ISBN 978-*
21 *88-422-2444-0.*

22 Battistoni, C., Giraldo Nohra, C., & Barbero, S., 2019. A Systemic Design Method to Approach Future
23 Complex Scenarios and Research Towards Sustainability: A Holistic Diagnosis Tool. *Sustainability*, 11(16),
24 4458. doi:10.3390/su11164458

25 Bistagnino, L., 2011. *Systemic Design, Designing the Productive and Environmental Sustainability*, 2nd
26 ed.; Slow Food: Bra, Italy.

27 Bradley, R., Jawahir, I. S., Badurdeen, F., & Rouch, K. 2018. A total life cycle cost model (TLCCM) for the
28 circular economy and its application to post-recovery resource allocation. *Resources, Conservation and*
29 *Recycling*, 135, 141-149.

30 Brundage, M. P., Bernstein, W. Z., Hoffenson, S., Chang, Q., Nishi, H., Kliks, T., & Morris, K. C. 2018.
31 *Analysing environmental sustainability methods for use earlier in the product lifecycle. Journal of cleaner*
32 *production*, 187, 877-892.

33 Castiglione, C., & Alfieri, A. 2019. Supply chain and eco-industrial park concurrent design. *IFAC-*
34 *PapersOnLine*, 52(13), 1313-1318. Doi: <https://doi.org/10.1016/j.ifacol.2019.11.380>

35 Castiglione, C. & Alfieri, A., 2020. Economic sustainability under supply chain and eco-industrial park
36 concurrent design. *Procedia CIRP*, 90, pp.19-24. Doi: <https://doi.org/10.1016/j.procir.2020.01.086>

37 Castiglione, C., Yazan, D. M., Alfieri, A., & Mes, M. R. K. 2021. A holistic technological eco-innovation
38 methodology for industrial symbiosis development. *Sustainable Production and Consumption*, 28, 1538-
39 1551. Doi: <https://doi.org/10.1016/j.spc.2021.09.002>

40 Castiglione, C., Pastore, E., & Alfieri, A. 2022. Technical, economic, and environmental performance
41 assessment of manufacturing systems: the multi-layer enterprise input-output formalisation method.
42 *Production Planning & Control*, 1-18. Doi: <https://doi.org/10.1080/09537287.2022.2054743>

- 1 Chatterjee, A., & Layton, A. 2020. Mimicking nature for resilient resource and infrastructure network
2 design. *Reliability Engineering & System Safety*, 204, 107142.
- 3 Chatterjee, A., Brehm, C., & Layton, A. 2021. Evaluating benefits of ecologically-inspired nested
4 architectures for industrial symbiosis. *Resources, Conservation and Recycling*, 167, 105423.
- 5 Chertow, M. & Ehrenfeld, J., 2012. Organising self-organising systems: Toward a theory of industrial
6 symbiosis. *Journal of industrial ecology*, 16(1), pp.13-27.
- 7 Dave, T., & Layton, A. 2020. Designing ecologically-inspired robustness into a water distribution network.
8 *Journal of Cleaner Production*, 254, 120057.
- 9 Fiore, E., Stabellini, B. & Tamborrini, P., 2020. A Systemic Design Approach Applied to Rice and Wine
10 Value Chains. The Case of the InnovaEcoFood Project in Piedmont (Italy). *Sustainability*, 12(21), p.9272.
- 11 Fraccascia, L., 2019. The impact of technical and economic disruptions in industrial symbiosis
12 relationships: An enterprise input-output approach. *International journal of production economics*, 213,
13 pp.161-174.
- 14 Gaiardo, A., 2016. Innovation, Entrepreneurship and Sustainable Design. A Methodology Proposal for
15 Sustainable Innovation Initiatives. Ph.D. Thesis, Politecnico di Torino, Turin, Italy.
- 16 Geissdoerfer, M., Savaget, P., Bocken, N.M. & Hultink, E.J., 2017. The Circular Economy—A new
17 sustainability paradigm?. *Journal of cleaner production*, 143, pp.757-768.
- 18 Genc, O., van Capelleveen, G., Erdis, E., Yildiz, O. & Yazan, D.M., 2019. A socio-ecological approach to
19 improve industrial zones towards eco-industrial parks. *Journal of environmental management*, 250,
20 p.109507.
- 21 Ghisellini, P.; Cialani, C.; Ulgiati, S., 2016. A review on circular economy: The expected transition to a
22 balanced interplay of environmental and economic systems. *J. Clean. Prod.* 114, 11–32.
- 23 Govindan, K. & Hasanagic, M., 2018. A systematic review on drivers, barriers, and practices towards
24 circular economy: a supply chain perspective. *International Journal of Production Research*, 56(1-2), pp.278-
25 311.
- 26 Herczeg, G., Akkerman, R., & Hauschild, M. Z. 2018. Supply chain collaboration in industrial symbiosis
27 networks. *Journal of Cleaner Production*, 171, 1058-1067.
- 28 Kirchherr, J., Reike, D. & Hekkert, M., 2017. Conceptualising the circular economy: An analysis of 114
29 definitions. *Resources, conservation and recycling*, 127, pp.221-232.
- 30 Layton, A., Bras, B., & Weissburg, M. 2016. Designing industrial networks using ecological food web
31 metrics. *Environmental science & technology*, 50(20), 11243-11252.
- 32 Lybæk, R., Christensen, T. B., & Thomsen, T. P. 2021. Enhancing policies for deployment of Industrial
33 symbiosis—What are the obstacles, drivers and future way forward?. *Journal of Cleaner Production*, 280,
34 124351.
- 35 Malone, S. M., Weissburg, M. J., & Bras, B. 2018. Industrial ecosystems and food webs: An ecological-
36 based mass flow analysis to model the progress of steel manufacturing in China. *Engineering*, 4(2), 209-217.
- 37 Mattila, T. J., Pakarinen, S., & Sokka, L. 2010. Quantifying the total environmental impacts of an industrial
38 symbiosis—a comparison of process-, hybrid and input–output life cycle assessment. *Environmental science &
39 technology*, 44(11), 4309-4314.

1 Nations, U., 2015. Transforming our world: The 2030 agenda for sustainable development. New York:
2 United Nations, Department of Economic and Social Affairs.

3 Neves, A., Godina, R., G Azevedo, S., Pimentel, C., & CO Matias, J. 2019. The potential of industrial
4 symbiosis: Case analysis and main drivers and barriers to its implementation. *Sustainability*, 11(24), 7095.

5 Pereno, A., & Barbero, S., 2020. Systemic design for territorial enhancement: an overview on design tools
6 supporting socio-technical system innovation. *Strategic Design Research Journal*, volume 13, number 02, May
7 – August 2020. 113-136. Doi: 10.4013/sdrj.2020.132.02

8 Saavedra, Y.M., Iritani, D.R., Pavan, A.L. & Ometto, A.R., 2018. Theoretical contribution of industrial
9 ecology to circular economy. *Journal of cleaner production*, 170, pp.1514-1522.

10 Sellitto, M. A., Murakami, F. K., Butturi, M. A., Marinelli, S., Kadel Jr, N., & Rimini, B. 2021. Barriers, drivers,
11 and relationships in industrial symbiosis of a network of Brazilian manufacturing companies. *Sustainable*
12 *Production and Consumption*, 26, 443-454.

13 Seuring, S. 2004. Industrial ecology, life cycles, supply chains: differences and interrelations. *Business*
14 *strategy and the Environment*, 13(5), 306-319.

15 Sonogo, M., Echeveste, M. E. S., & Debarba, H. G. (2018). The role of modularity in sustainable design: A
16 systematic review. *Journal of Cleaner Production*, 176, 196-209.

17 Song, X., Geng, Y., Dong, H. & Chen, W., 2018. Social network analysis on industrial symbiosis: A case of
18 Gujiao eco-industrial park. *Journal of Cleaner Production*, 193, pp.414-423.

19 Tian, J., Liu, W., Lai, B., Li, X., & Chen, L. 2014. Study of the performance of eco-industrial park
20 development in China. *Journal of Cleaner Production*, 64, 486-494.

21 United Nations General Assembly. 1987. Report of the world commission on environment and
22 development: Our common future. Oslo, Norway: United Nations General Assembly, Development and
23 International Co-operation: Environment.

24 United Nations. 2015. Transforming our world: The 2030 agenda for sustainable development.
25 Resolution adopted by the General Assembly,(A/RES/70/1). In: (2015).

26 Valentine, S. V. 2016. Kalundborg Symbiosis: Fostering progressive innovation in environmental
27 networks. *Journal of Cleaner Production*, 118, 65-77.

28 Von Bertalanffy, L., 1969. *General System Theory: Foundations, Development, Applications*; George
29 Braziller: New York, NY, USA.

30 Watson, B. C., Malone, S., Weissburg, M., & Bras, B. 2020. Adding a Detrital Actor to Increase System of
31 System Resilience: A Case Study Test of a Biologically Inspired Design Heuristic to Guide Sociotechnical
32 Network Evolution. *Journal of Mechanical Design*, 142(12), 121705.

33 Yap, N. T., & Devlin, J. F. 2017. Explaining industrial symbiosis emergence, development, and disruption:
34 a multilevel analytical framework. *Journal of industrial Ecology*, 21(1), 6-15.

35 Yazan, D. M., & Fraccascia, L. 2020. Sustainable operations of industrial symbiosis: an enterprise input-
36 output model integrated by agent-based simulation. *International Journal of Production Research*, 58(2),
37 392-414.

38 Yeo, Z., Masi, D., Low, J. S. C., Ng, Y. T., Tan, P. S., & Barnes, S. 2019. Tools for promoting industrial
39 symbiosis: A systematic review. *Journal of Industrial Ecology*, 23(5), 1087-1108.

1 **APPENDIX A**

2 *Table A1. The RA MEIO table for the production activities from P1 to P6.*

Resource-Activity MEIO table	P1	P2	P3	P4	P5	P6
<i>Fresh marc (kg)</i>	1/-	-/-	-/-	-/-	-/-	-/-
<i>Dry marc (kg)</i>	-/0.47	1/-	-/-	-/-	-/-	-/-
<i>Marc flour 10 mm (kg)</i>	-/-	-/0.995	1/-	-/-	-/-	-/-
<i>Marc flour 0.5 mm (kg)</i>	-/-	-/-	-/0.99	1/-	-/-	-/-
<i>Marc flour FOOD (kg)</i>	-/-	-/-	-/-	-/1	-/-	-/-
<i>Fresh rice husk (kg)</i>	-/-	-/-	-/-	-/-	1/-	-/-
<i>Dry rice husk (kg)</i>	-/-	-/-	-/-	-/-	-/-	-/-
<i>Rice husk flour 0.5 mm (kg)</i>	-/-	-/-	-/-	-/-	-/0.99	1/-
<i>Rice husk flour FOOD (kg)</i>	-/-	-/-	-/-	-/-	-/-	-/1
<i>Rice husk butter (kg)</i>	-/-	-/-	-/-	-/-	-/-	-/-
<i>Taralli (kg)</i>	-/-	-/-	-/-	-/-	-/-	-/-
<i>Crackers (kg)</i>	-/-	-/-	-/-	-/-	-/-	-/-
<i>Cream (kg)</i>	-/-	-/-	-/-	-/-	-/-	-/-
<i>Almonds (kg)</i>	-/-	-/-	-/-	-/-	-/-	-/-
<i>Power (kWh)</i>	0.05/-	0.01/-	0.1/-	0.1/-	0.1/-	0.1/-
<i>Heat (kWh)</i>	1/-	-/-	-/-	1/-	-/-	1/-
<i>Used power (kWh)</i>	-/0.05	-/0.01	-/0.1	-/0.1	-/0.1	-/0.1
<i>Used heat (kWh)</i>	-/1	-/-	-/-	-/1	-/-	-/1
<i>Dissipated heat (kWh)</i>	-/-	-/-	-/-	-/-	-/-	-/-
<i>Freshwater (kg)</i>	-/-	-/-	-/-	0.07/-	-/-	0.07/-
<i>Waste marc flour 10 mm (kg)</i>	-/-	-/0.005	-/-	-/-	-/-	-/-
<i>Waste marc flour 0.5 mm (kg)</i>	-/-	-/-	-/0.01	-/-	-/-	-/-
<i>Waste rice husk flour 0.5 mm (kg)</i>	-/-	-/-	-/-	-/-	-/0.01	-/-
<i>Waste rice husk extracted (kg)</i>	-/-	-/-	-/-	-/-	-/-	-/-

Wastewater (kg)	-/0.53	-/-	-/-	-/0.07	-/-	-/0.07
CO ₂ (kg)	-/-	-/-	-/-	-/-	-/-	-/-
Waste CO ₂ (kg)	-/-	-/-	-/-	-/-	-/-	-/-
Waste humid mixture (kg)	-/-	-/-	-/-	-/-	-/-	-/-

1
2

Table A2. The RA MEIO table for the production activities from P7 to P11

Resource-Activity MEIO table	P7	P8	P9	P10	P11
Fresh marc (kg)	-/-	-/-	-/-	-/-	-/-
Dry marc (kg)	-/-	-/-	-/-	-/-	-/-
Marc flour 10 mm (kg)	-/-	-/-	-/-	-/-	-/-
Marc flour 0.5 mm (kg)	-/-	-/-	-/-	-/-	-/-
Marc flour FOOD (kg)	-/-	-/-	0.277/-	0.277/-	0.277/-
Fresh rice husk (kg)	1/-	-/-	-/-	-/-	-/-
Dry rice husk (kg)	-/0.987	1/-	-/-	-/-	-/-
Rice husk flour 0.5 mm (kg)	-/-	-/-	-/-	-/-	-/-
Rice husk flour FOOD (kg)	-/-	-/-	0.277/-	0.277/-	0.277/-
Rice husk butter (kg)	-/-	-/0.02	0.01/-	0.01/-	0.1/-
Taralli (kg)	-/-	-/-	-/-	-/1	-/-
Crackers (kg)	-/-	-/-	-/1	-/-	-/-
Cream (kg)	-/-	-/-	-/-	-/-	-/1
Almonds (kg)	-/-	-/-	-/-	-/-	0.3/-
Power (kWh)	30/-	6.5/-	0.12/-	0.9/-	0.27/-
Heat (kWh)	-/-	1.84/-	-/-	-/-	-/-
Used power (kWh)	-/30	-/6.5	-/0.12	-/0.9	-/0.27
Used heat (kWh)	-/-	-/1.84	-/-	-/-	-/-
Dissipated heat (kWh)	-/-	-/-	-/-	-/-	-/-
Freshwater (kg)	-/-	-/-	3/-	2/-	3/-
Waste marc flour 10 mm (kg)	-/-	-/-	-/-	-/-	-/-

Waste marc flour 0.5 mm (kg)	-/-	-/-	-/-	-/-	-/-
Waste rice husk flour 0.5 mm (kg)	-/-	-/-	-/-	-/-	-/-
Waste rice husk extracted (kg)	-/-	-/0.98	-/-	-/-	-/-
Wastewater (kg)	-/0.013	-/-	-/-	-/-	-/-
CO ₂ (kg)	-/-	60/55	-/-	-/-	-/-
Waste CO ₂ (kg)	-/-	-/5	-/-	-/-	-/-
Waste humid mixture (kg)	-/-	-/-	-/2.555	-/1.555	-/2.555

1
2

Table A3. The AP MEIO table for the production activities from P1 to P6.

Activity- Parameters MEIO table	P1	P2	P3	P4	P5	P6
<i>Description</i>	marc drying	marc crushing	marc cryo-grinding	marc final drying	rice husk cryo-grinding	rice husk final drying
<i>Activity type</i>	production	production	production	production	production	production
<i>ID Activity</i>	1	2	3	4	5	6
<i>ID resource involved</i>	1	2	3	4	3	4
<i>Max Capacity(kg/hr)</i>	-	-	-	-	-	-
<i>Scrap (%)</i>	0%	0.5%	1%	-	1/-	-
<i>Operating cost (€/kg)</i>	-	-	-	-	-	-
<i>P1 distance from (km)</i>	-	0	0	0	0	0
<i>P2 distance from (km)</i>	0	-	0	0	0	0
<i>P3 distance from (km)</i>	0	0	-	0	0	0
<i>P4 distance from (km)</i>	0	0	0	-	0	0
<i>P5 distance from (km)</i>	0	0	0	0	-	0
<i>P6 distance from (km)</i>	0	0	0	0	0	-
<i>P7 distance from (km)</i>	0	0	0	0	0	0
<i>P8 distance from (km)</i>	0	0	0	0	0	0
<i>P9 distance from (km)</i>	0	0	0	0	0	0

<i>P10 distance from (km)</i>	0	0	0	0	0	0
<i>P11 distance from (km)</i>	0	0	0	0	0	0

1
2

Table A4. The AP MEIO table for the production activities from P7 to P11.

Activity-Parameters MEIO table	P7	P8	P9	P10	P11
<i>Description</i>	rice husk drying	rice husk butter extraction	cracker production	taralli production	almond cream production
<i>Activity type</i>	production	production	production	production	production
<i>ID Activity</i>	7	8	9	10	11
<i>ID resource involved</i>	5	6	7	7	7
<i>Max Capacity(kg/hr)</i>	-	8	3	3	3
<i>Scrap (%)</i>	0%	0.5%	1%	-	1/-
<i>Operating cost (€/kg)</i>	9	-	-	-	-
<i>P1 distance from (km)</i>	-	0	0	0	0
<i>P2 distance from (km)</i>	0	-	0	0	0
<i>P3 distance from (km)</i>	0	0	-	0	0
<i>P4 distance from (km)</i>	0	0	0	-	0
<i>P5 distance from (km)</i>	0	0	0	0	-
<i>P6 distance from (km)</i>	0	0	0	0	0
<i>P7 distance from (km)</i>	0	0	0	0	0
<i>P8 distance from (km)</i>	0	0	0	0	0
<i>P9 distance from (km)</i>	0	0	0	0	0
<i>P10 distance from (km)</i>	0	0	0	0	0
<i>P11 distance from (km)</i>	0	0	0	0	0

3
4

Table A5. The RF MEIO table for the production activities from P1 to P6.

Resource-Function MEIO table	P1	P2	P3	P4	P5	P6
<i>Fresh marc (kg)</i>	*X;-	-;	-;	-;	-;	-;

<i>Dry marc (kg)</i>	-;Y=0.47X	*X;-	-;	-;	-;	-;
<i>Marc flour 10 mm (kg)</i>	-;	-;Y=0.995X	*X;-	-;	-;	-;
<i>Marc flour 0.5 mm (kg)</i>	-;	-;	-;Y=0.99X	*X;-	-;	-;
<i>Marc flour FOOD (kg)</i>	-;	-;	-;	-;Y=X	-;	-;
<i>Fresh rice husk (kg)</i>	-;	-;	-;	-;	*X;-	-;
<i>Dry rice husk (kg)</i>	-;	-;	-;	-;	-;	-;
<i>Rice husk flour 0.5 mm (kg)</i>	-;	-;	-;	-;	-;Y=0.99X	*X;-
<i>Rice husk flour FOOD (kg)</i>	-;	-;	-;	-;	-;	-;Y=X
<i>Rice husk butter (kg)</i>	-;	-;	-;	-;	-;	-;
<i>Taralli (kg)</i>	-;	-;	-;	-;	-;	-;
<i>Crackers (kg)</i>	-;	-;	-;	-;	-;	-;
<i>Cream (kg)</i>	-;	-;	-;	-;	-;	-;
<i>Almonds (kg)</i>	-;	-;	-;	-;	-;	-;
<i>Power (kWh)</i>	Y=0.05X;-	Y=0.1X;-	Y=0.1X;-	Y=0.1X;-	Y=0.1X;-	Y=0.1X;-
<i>Heat (kWh)</i>	Y=X;-	-;	-;	Y=X;-	-;	Y=X;-
<i>Used power (kWh)</i>	-;Y=0.05X	-;Y=0.1X	-;Y=0.1X	-;Y=0.1X	-;Y=0.1X	-;Y=0.1X
<i>Used heat (kWh)</i>	-;Y=X	-;	-;	-;Y=X	-;	-;Y=X
<i>Dissipated heat (kWh)</i>	-;	-;	-;	-;	-;	-;
<i>Freshwater (kg)</i>	-;	-;	-;	Y=0.07X;-	-;	Y=0.07X;-
<i>Waste marc flour 10 mm (kg)</i>	-;	-;Y=0.005X	-;	-;	-;	-;
<i>Waste marc flour 0.5 mm (kg)</i>	-;	-;	-;Y=0.01X	-;	-;	-;
<i>Waste rice husk flour 0.5 mm (kg)</i>	-;	-;	-;	-;	-;	-;
<i>Waste rice husk extracted (kg)</i>	-;	-;	-;	-;	-;	-;
<i>Wastewater (kg)</i>	-;Y=0.53X	-;	-;	-;Y=0.07X	-;	-;Y=0.07X
<i>CO₂ (kg)</i>	-;	-;	-;	-;	-;	-;
<i>Waste CO₂ (kg)</i>	-;	-;	-;	-;	-;	-;
<i>Waste humid mixture (kg)</i>	-;	-;	-;	-;	-;	-;

1 Table A6. The RF MEIO table for the activities from P7 to P11.

Resource-Function MEIO table	P7	P8	P9	P10	P11
<i>Fresh marc (kg)</i>	-;	-;	-;	-;	-;
<i>Dry marc (kg)</i>	-;	-;	-;	-;	-;
<i>Marc flour 10 mm (kg)</i>	-;	-;	-;	-;	-;
<i>Marc flour 0.5 mm (kg)</i>	-;	-;	-;	-;	-;
<i>Marc flour FOOD (kg)</i>	-;	-;	Y=0.277X;-	Y=0.277X;-	Y=0.277X;-
<i>Fresh rice husk (kg)</i>	*X;-	-;	-;	-;	-;
<i>Dry rice husk (kg)</i>	-;Y=0.987X	*X;-	-;	-;	-;
<i>Rice husk flour 0.5 mm (kg)</i>	-;	-;	-;	-;	-;
<i>Rice husk flour FOOD (kg)</i>	-;	-;	Y=0.277X;-	Y=0.277X;-	Y=0.277X;-
<i>Rice husk butter (kg)</i>	-;	-;Y=0.02X	Y=0.01X;-	Y=0.01X;-	Y=0.1X;-
<i>Taralli (kg)</i>	-;	-;	-;	-;X*	-;
<i>Crackers (kg)</i>	-;	-;	-;X*	-;	-;
<i>Cream (kg)</i>	-;	-;	-;	-;	-;X*
<i>Almonds (kg)</i>	-;	-;	-;	-;	Y=0.3X;-
<i>Power (kWh)</i>	Y=30X;-	Y=6.5X;-	Y=0.12X;-	Y=0.9X;-	Y=0.27X;-
<i>Heat (kWh)</i>	-;	Y=1.84X;-	-;	-;	-;
<i>Used power (kWh)</i>	-; Y=30X	-;Y=6.5X	-;Y=0.12X	-;Y=0.9X	-; Y=0.27X
<i>Used heat (kWh)</i>	-;	-;Y=1.84X	-;	-;	-;
<i>Dissipated heat (kWh)</i>	-;	-;	-;	-;	-;
<i>Freshwater (kg)</i>	-;	-;	Y=3X;-	Y=2X;-	Y=3X;-
<i>Waste marc flour 10 mm (kg)</i>	-;	-;	-;	-;	-;
<i>Waste marc flour 0.5 mm (kg)</i>	-;	-;	-;	-;	-;
<i>Waste rice husk flour 0.5 mm (kg)</i>	-;	-;	-;	-;	-;
<i>Waste rice husk extracted (kg)</i>	-;	-;Y=0.98X	-;	-;	-;
<i>Wastewater (kg)</i>	-;Y=0.013X	-;	-;	-;	-;

<i>CO₂ (kg)</i>	-;-	Y=60;Y=55	-;-	-;-	-;-
<i>Waste CO₂ (kg)</i>	-;-	-; Y=5	-;-	-;-	-;-
<i>Waste humid mixture (kg)</i>	-;-	-;-	-;Y=2.564X	-;Y=1.564X	-;Y=2.954X

1

2

3

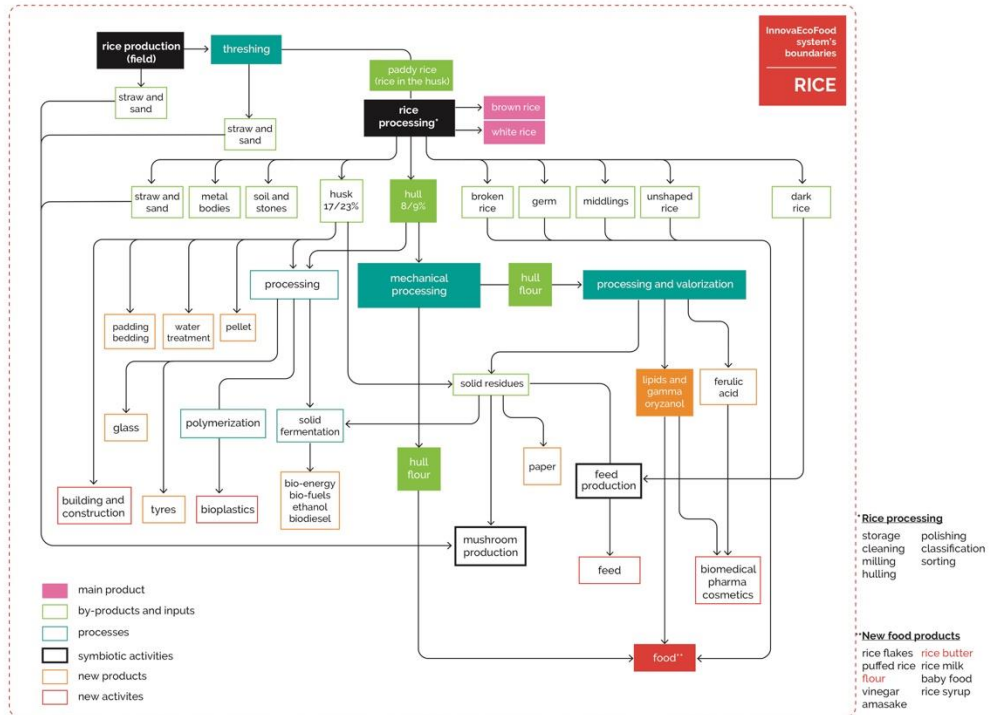

1

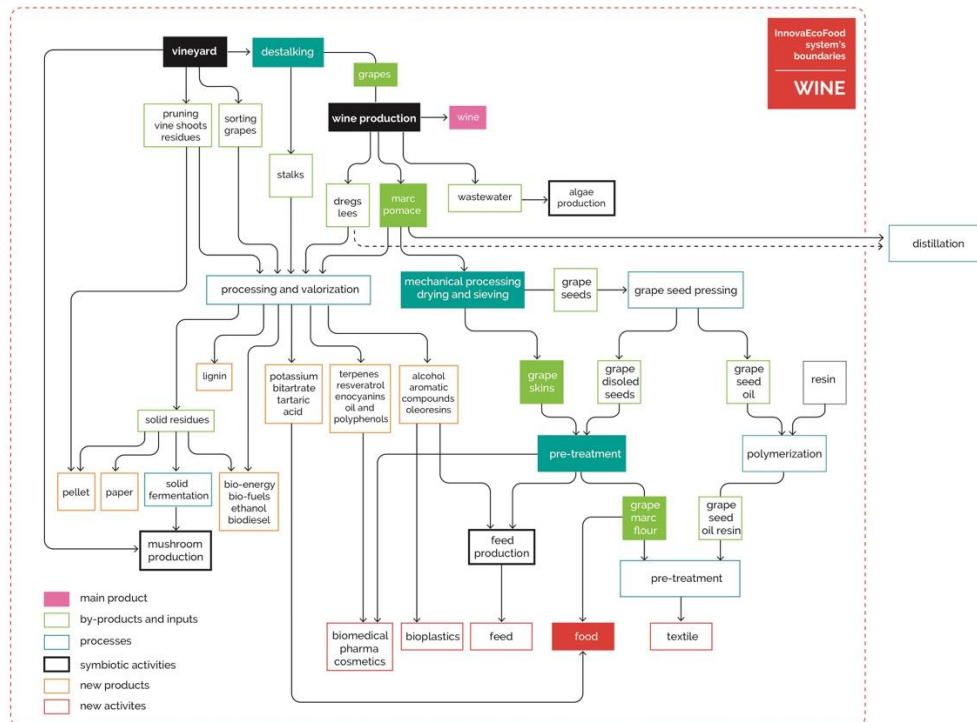

2

Figure A1. Systemic value chains proposed for rice and wine in the InnovaEcoFood project

3