

Design, Manufacture and Measurement of three Permanent Magnet Dipoles for FASER Experiment

*Original*

Design, Manufacture and Measurement of three Permanent Magnet Dipoles for FASER Experiment / Thonet, P. A.; Dunkel, O.; Liebsch, M.; Pentella, M.; Petrone, C.. - In: IEEE TRANSACTIONS ON APPLIED SUPERCONDUCTIVITY. - ISSN 1051-8223. - ELETTRONICO. - 32:6(2022), pp. 1-5. [10.1109/TASC.2022.3191284]

*Availability:*

This version is available at: 11583/2970486 since: 2022-08-05T08:49:36Z

*Publisher:*

IEEE

*Published*

DOI:10.1109/TASC.2022.3191284

*Terms of use:*

This article is made available under terms and conditions as specified in the corresponding bibliographic description in the repository

*Publisher copyright*

IEEE postprint/Author's Accepted Manuscript

©2022 IEEE. Personal use of this material is permitted. Permission from IEEE must be obtained for all other uses, in any current or future media, including reprinting/republishing this material for advertising or promotional purposes, creating new collecting works, for resale or lists, or reuse of any copyrighted component of this work in other works.

(Article begins on next page)

# Design, Manufacture and Measurement of three Permanent Magnet Dipoles for FASER Experiment

P.A. Thonet, O. Dunkel, M. Liebsch, M. Pentella, C. Petrone

**Abstract**— FASER, the ForWard Search ExpeRiment, is designed to search for new, yet undiscovered, light and weakly-interacting particles and study the interactions of high-energy neutrinos. Three dipoles, one 1.5 m-long and the other two 1.0 m-long each, installed upstream of the ATLAS experiment at CERN, are required to achieve sufficient separation of pairs of oppositely charged, high-energy Standard Model particles originating from decays of new physics particles.

The dipoles have an aperture of 200 mm in diameter and a required magnetic field at the centre  $\geq 0.55$  T. Due to tight space constraints, a design based on permanent magnet technology was proposed. This paper describes the design, manufacturing, assembly and magnetic measurement of these large Halbach array dipoles.

**Index Terms**— FASER, Halbach, Permanent Magnet, dipole.

## I. INTRODUCTION

FASER [1][2][3] is a new experiment at the CERN Large Hadron Collider (LHC) designed to search for light, weakly-interacting new particles produced in the LHC collisions. It was installed in the LHC complex in late 2020 and during 2021. Some new particles may be produced in large number during proton-proton collisions in LHC and may not be detected. These long-lived particles would follow the collision axis direction without interaction with magnetic field and then after few hundred meters decay to standard model particles, for example, electron-positron pairs. The detector is positioned on the beam collision axis line-of-sight (LOS) 480 m from the ATLAS collision point (IP1) in an unused service tunnel, TI12. The location of FASER is shown in Fig. 1 and a sketch of the FASER detector is detailed in Fig. 2.

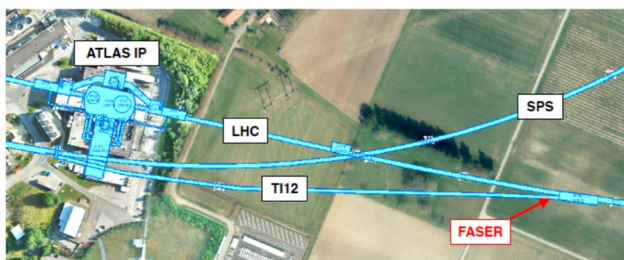

Fig. 1. FASER experiment location in LHC.

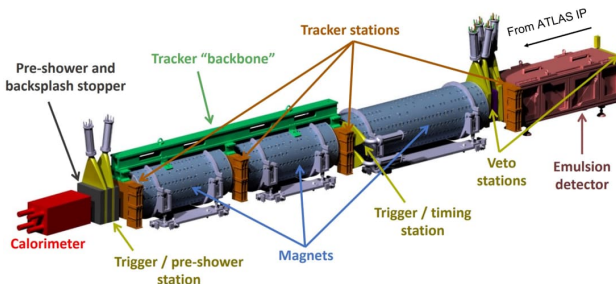

Fig. 2. FASER detector.

TABLE I  
MAIN DESIGN PARAMETERS OF THE FASER DIPOLES

Parameter	Short model	Long model	Unit
Aperture diameter	200	200	mm
Length	1000	1500	mm
Outer diameter	430	430	mm
Mass	914	1331	kg
Mass of permanent magnet	606	909	kg
Nominal field at the center	0.576	0.576	T
Good Field Region radius	67	67	mm
Field homogeneity in GFR	$\leq \pm 3$	$\leq \pm 3$	%
Permanent magnet material	Sm <sub>2</sub> Co <sub>17</sub>	Sm <sub>2</sub> Co <sub>17</sub>	

The three dipole magnets installed in FASER detector are based on a Halbach array permanent magnet (PM) design. The longest, a 1.5-m-long surrounds the decay volume to start the separation of oppositely charged particles. It is followed by two 1-m-long dipoles installed along the tracking spectrometer. They produce a field of 0.57 T inside an aperture diameter of 200 mm. The main parameters are listed in Table I.

The main advantage of the Halbach design is to produce a high and homogeneous field inside a large aperture while keeping compact overall dimensions. As indicated in Fig. 3, the location where FASER detector is installed in LHC TI12 tunnel implies tight dimensional constraints for the dipoles. Only 250 mm are available between the tunnel floor and the dipole central axis, aligned on the LOS. The same distance of 250 mm is available between the tunnel vault side and the LOS. The overall length of the detector is limited to 5 m and some free space is required between the dipoles for the installation of scintillators and tracking stations.

Manuscript receipt and acceptance dates will be inserted here.

P.A. Thonet, O. Dunkel, M. Liebsch, M. Pentella and C. Petrone are with the CERN, Geneva, CH-1211, Switzerland (e-mail: Pierre.Alexandre.Thonet@cern.ch).

Color versions of one or more of the figures in this paper are available online at <http://ieeexplore.ieee.org>.

Digital Object Identifier will be inserted here upon acceptance.



Fig. 3. TI12 tunnel before (left) and after (right) FASER installation.

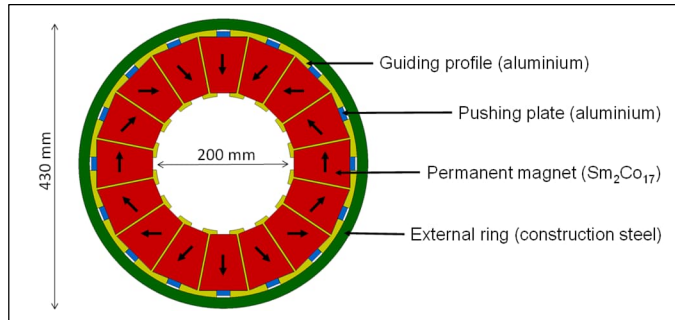

Fig. 4. Cross section of FASER dipole.

Halbach arrays, invented in the 1980s by the physicist Klaus Halbach, are largely used in particle accelerators [4]. Most of the time this configuration is exploited in small to medium size designs, installed in linacs, for example. Larger designs requiring more permanent magnet material are rarely used due to the complexity of the assembly. In this case, the permanent magnets are generally glued together to manage the strong magnetic forces resulting in a complicated and long assembly process.

A new concept was developed for FASER dipoles to replace the gluing of the magnets by a mechanical structure to insert the magnets inside the dipole, reducing the assembly time and improving the safety of handling the permanent magnets.

## II. DESIGN

The design is based on a Halbach array with 16 magnet sectors. The number of sectors was defined to keep the permanent magnet blocks in reasonable dimensions and to provide a field homogeneity better than  $\pm 3\%$  inside the whole dipole aperture. The cross section of the dipole, identical for short and long model, is detailed in Fig. 4.

The permanent magnet blocks, made of Rare Earth Samarium Cobalt  $\text{Sm}_2\text{Co}_{17}$ , have a trapezoidal shape, with five different easy axis orientations to shape the dipolar field in aperture. They are installed inside a structure made of aluminium guiding profiles attached to an external steel ring. The PM blocks are locked in position with aluminium pushing plates.

### A. Magnetic design

The main parameters as the number of sectors in the array, the PM grade and geometry, and the dipole dimensions were

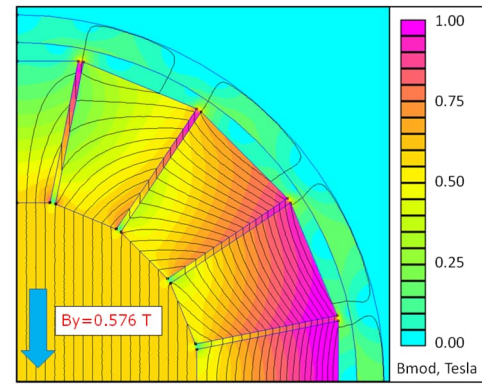

Fig. 5. 2D magnetic field distribution.

defined with the 2D magnetic design shown in Fig. 5, using FEMM [5]. The maximum clearance between magnet sectors has been set to 3 mm to limit the impact on field homogeneity and, at the same time, on the rigidity of the aluminium guiding profiles.

The effects of magnet imperfections on the field quality were studied with Opera-3D/TOSCA [6]. As the example described in Fig. 6, deviations on magnetization and geometry were applied to some of the magnet sectors and the consequence on field quality degradation was evaluated through a harmonic analysis, shown in Fig. 7. The tolerances on PM blocks were then specified accordingly:

- Dimensions:  $\pm 0.025$  mm.
- Maximum error on easy axis direction:  $\pm 3^\circ$ .
- Magnetic characteristics ( $B_r$  and  $H_{cb}$ ):  $\pm 2\%$ .

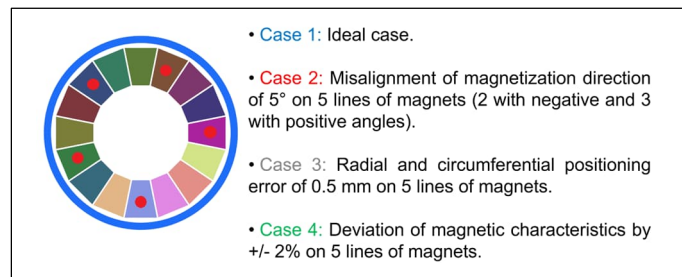

Fig. 6. Deviations applied on magnet sectors with red dots.

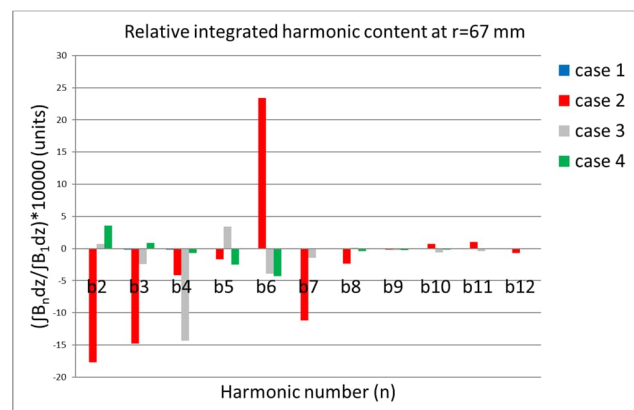

Fig. 7. Effects of permanent magnet blocks irregularities on field quality.

## B. Components and materials

The magnets were produced with Samarium Cobalt grade YXG32H which features an energy product,  $BH_{\max}$  of 255 kJ/m<sup>3</sup>, a residual induction,  $B_r$  of 1.12 T and an intrinsic coercivity,  $H_{cj} \geq 1990$  kA/m. The good temperature stability and high intrinsic coercivity minimizing the risk of local demagnetization during assembly were the main reasons to use Samarium Cobalt for FASER dipoles. Each PM block was made of two parts glued together with the joint plane parallel or perpendicular to the magnetization direction. In total 672 blocks with five different easy axis orientations were required for FASER, with a total mass of 2130 kg.

The external ring was made of construction steel grade S355JR. Non-magnetic material such as stainless steel could also be used, but soft magnetic material has the advantage of creating a radial magnetic shielding and, therefore, more stability for magnetic forces during assembly, as the PM blocks are attracted to this external ring until the insertion of the last magnet sector.

The guiding profiles made of aluminium grade 6082 were originally designed as extruded parts, however, they were finally made by machining due to manufacturing issues.

## C. Assembly

The guiding profiles holding the PM blocks in the assembly are also used for the PM blocks insertion as shown in Fig. 8 and Fig. 9. The profiles are manufactured 0.5 m longer than the external ring. Each PM block is inserted between two profiles without external forces, pushed inside the dipole assembly with a dedicated tooling and locked in position with an aluminium pushing plate. The magnetic forces during assembly were modelled to define the optimal insertion sequence [7]. At the end of the assembly the extra length on guiding profile was trimmed off and a protection cover was installed.

## III. MAGNETIC MEASUREMENTS

### A. Permanent magnet block characterisation

The 672 permanent magnet blocks were individually characterized at CERN. The magnetic moment and the deviation of magnetization direction were measured to avoid polarity errors and important field inhomogeneity, almost impossible to correct on the assembled dipoles. The measurements were carried out with a three-dimensional Helmholtz-Coil [8]. A voltage signal measured on the coils is generated by the magnetic moment variation when the magnet is rotated. This signal is then time-integrated by CERN's "Fast Digital Integrators", FDI [9]. The magnetic moment is calculated as:

$$M = k \int_0^t v(\tau) d\tau$$

Where  $k$  is the sensitivity factor of the Helmholtz-Coils used as pick-up coils. The module of the magnetic moment,  $m$  (A·m<sup>2</sup>) is determined as:

$$m = \sqrt{M_x^2(0^\circ) + M_y^2(0^\circ) + M_z^2(0^\circ)}$$

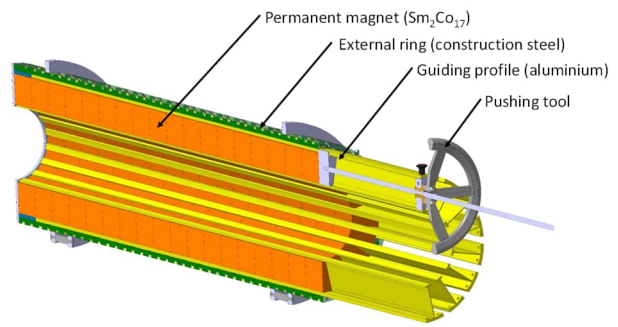

Fig. 8. Tooling for permanent magnet insertion.

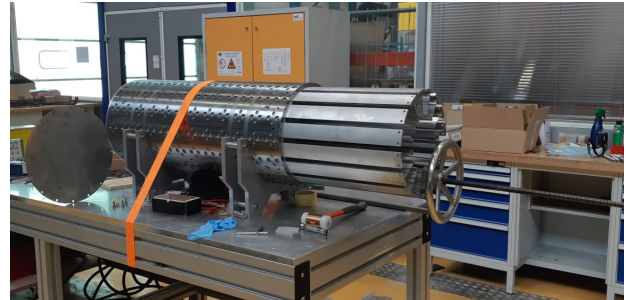

Fig. 9. Insertion of a permanent magnet block.

The previous operation is repeated after rotating the magnet by 90° to measure the third magnetic component not seen during the first measurement. After numerical transformation of the second measurement by -90°, the orientation of the magnetic field is defined with a horizontal and a vertical angle with respect to the coordinate system of the Helmholtz-Coil and expressed as follows:

$$\alpha = \frac{\text{atan}\left(\frac{M_y(0^\circ)}{M_x(0^\circ)}\right) - \text{atan}\left(\frac{M_y(180^\circ)}{M_x(180^\circ)}\right)}{2}$$

An average magnetic moment of 331.3 A·m<sup>2</sup> was measured over the magnet production with a peak-to-peak of ±2.0 % ( $\sigma = 0.6\%$ ).

The deviation of the magnetization direction was within ±1.44° ( $\sigma = 0.39^\circ$ ) in the horizontal plane and ±1.9° ( $\sigma = 0.49^\circ$ ) in the vertical plane.

As all PM blocks were within specified tolerances, it was not necessary to apply local field correction in the dipole assembly by assigning a specific position to each PM block.

### B. Magnetic measurements during assembly

A number of magnetic measurements were performed during the assembly process, mainly to avoid the risk of positioning or polarity error of a PM block. A tooling shown in Fig. 10, based on a rotating Hall probe and an angular encoder was developed. The Hall probe is rotated inside the dipole aperture after each slice assembly, corresponding to the insertion of 16 PM blocks. An error in the assembly, for instance a PM block installed in the wrong place, would generate a local deviation of the radial field,  $B_r$  as detailed in Fig. 11.



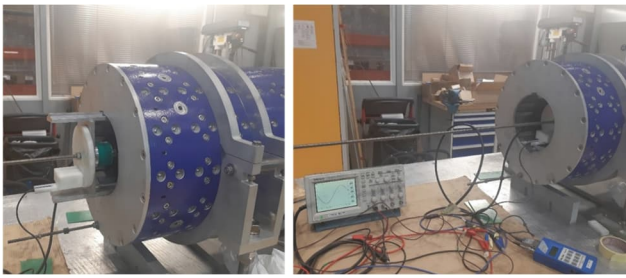

Fig. 10. Measurement of radial field,  $B_r$  inside the dipole aperture.

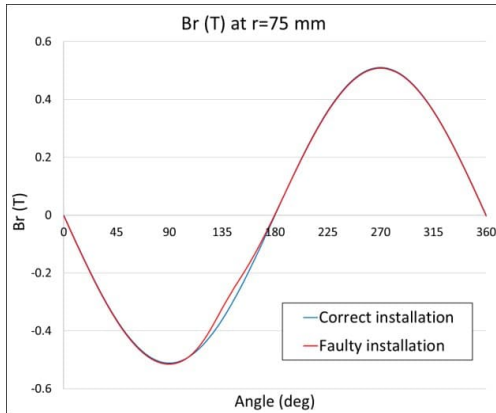

Fig. 11. Example of measured field values by rotating the Hall probe in a correct (blue) and a faulty installation (red).

### C. Magnetic measurements of the assembled dipoles

The assembled dipoles were measured with the single-stretched wire (SSW) [10] and the 3D Hall probe mapper.

The integrated field, the integrated 2D field homogeneity and field orthogonality, related to the optical reference targets with a laser system, were measured with the SSW. These measurements are summarized in Table II.

The measurements of integrated higher-order field harmonics, detailed in Fig. 12, were also done with the SSW, at the reference radius  $r = 67$  mm up to order  $N = 15$ . A sextupole ( $N = 3$ ) harmonic of 30 to 40 units is present in all three dipoles. According to past studies on Halbach arrays [11], this irregularity is due to small clearance between some of the magnets created by magnetic forces. Nevertheless, the magnetic measurements of the three FASER dipoles are within specified values.

The local field homogeneity was measured with the 3D Hall probe mapper. In addition, the local multipoles shown in Fig. 13 were mapped along the dipole  $z$ -axis, at a radius of 67 mm and can be correlated with some irregularities in the dipole slices assembly.

## IV. CONCLUSION

The design of the permanent magnet dipoles for FASER meets the tight design constraints in term of available space, large aperture with significant field and the cost-effectiveness.

Innovative assembly technology and magnetic measurement tools were developed for manufacturing these three dipoles providing new validated method for the assembly of large Halbach arrays.

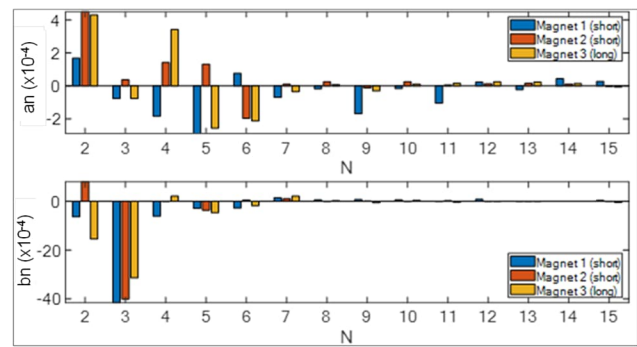

Fig. 12. Measured normal and skew relative integrated harmonic content expressed in unit of  $10^{-4}$  at a radius of 67 mm up to the 15<sup>th</sup> order.

TABLE II  
MEASURED INTEGRATED FIELD AND FIELD ORTHOGONALITY IN THE THREE DIPOLES

Magnet	Dipole 1 (short)	Dipole 2 (short)	Dipole 3 (long)	Unit
$\int B_x dl$	-0.57692	-0.57840	-0.86150	Tm
$\int B_y dl$	0.00021	0.00040	-0.00250	Tm
Roll Angle <sup>a</sup>	1.57045	1.57008	1.57366	rad

<sup>a</sup> Magnetic field direction with respect to horizontal plane.

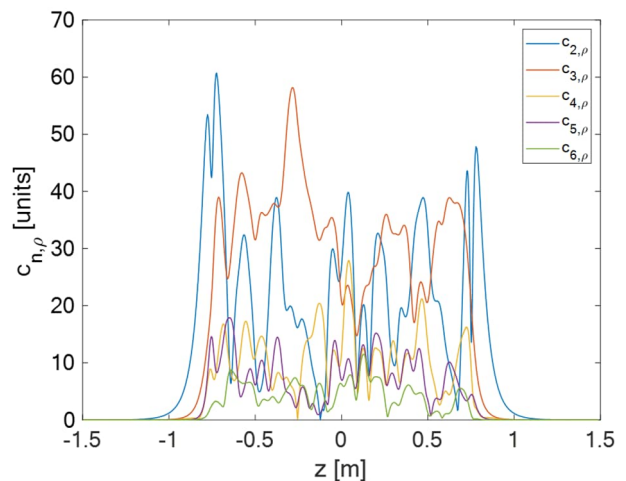

Fig. 13. Evolution of the first six harmonics expanded in  $B_p$  relative to  $B_z$  (long dipole), evaluated at a radius of 67 mm.

## ACKNOWLEDGMENT

The Authors would like to thank Romain Ferriere for having carried out the mechanical design and Jamie Boyd for his support in this project.

## REFERENCES

- [1] Jonathan L. Feng, Iftah Galon, Felix Kling, Sebastian Trojanowski, "FASER: ForwArd Search ExpeRiment at the LHC", *Phys. Rev. D* 97, 035001, 2018. Available: <https://arxiv.org/abs/1708.09389>.
- [2] CERN, FASER webpage. Available: <https://faser.web.cern.ch/>.
- [3] The Faser Collaboration, "The Faser Detector", to be published.
- [4] K. Halbach, "Design of Permanent Multipole Magnets with Oriented Rare Earth Cobalt Material", *NIM* 169, pp.1-10, 1980.
- [5] FEMM. Available: [www.femm.info](http://www.femm.info).
- [6] Dassault Systèmes, 78946 Vélizy-Villacoublay Cedex, France. Available: <https://www.3ds.com/fr/produits-et-services/simulia/produits/opera/>.
- [7] P.A. Thonet, "Design and manufacturing of three permanent magnet dipoles for FASER experiment", 2021. Available <https://indico.cern.ch/event/1010394/>.
- [8] V. Remondino; O. Dunkel; D. Giloteaux, "Design, Calibration and Qualification of the CERN Helmholtz coils system", CERN Technical Note 2017-05, 2017, Available: [https://edms.cern.ch/ui/file/1762799/2/2017\\_Remondino\\_-\\_Design\\_Calibration\\_and\\_Qualification\\_of\\_the\\_CERN\\_Helmholtz\\_coils\\_sytem.pdf](https://edms.cern.ch/ui/file/1762799/2/2017_Remondino_-_Design_Calibration_and_Qualification_of_the_CERN_Helmholtz_coils_sytem.pdf).
- [9] P. Arpaia, L. Bottura, L. Fiscarelli, and L. Walckiers. "Performance of a fast digital integrator in on-field magnetic measurements for particle accelerators", 2012. Available: <http://cds.cern.ch/record/1421568/files/CERN-ATS-2012-019.pdf?version=1>.
- [10] C. Petrone, "Wire methods for measuring field harmonics, gradients and magnetic axes in accelerator magnets", pp. 30-32, 2013. Available: [https://cds.cern.ch/record/1601973/files/CERN-THESIS-2013-130\\_2.pdf](https://cds.cern.ch/record/1601973/files/CERN-THESIS-2013-130_2.pdf).
- [11] K. Halbach, "Design of permanent multipole magnets with oriented rare earth cobalt material", pp. 6-7, 1979. Available: <https://www.sciencedirect.com/science/article/pii/0029554X80900944>.