

3D MODELS AND NON-DESTRUCTIVE INVESTIGATIONS: TOWARDS A MEETING IN DIGITAL TWINS

Original

3D MODELS AND NON-DESTRUCTIVE INVESTIGATIONS: TOWARDS A MEETING IN DIGITAL TWINS / Patrucco, G.; Perri, S.; Sammartano, G.; Fillia, E.; Matteini, I.; Lenticchia, E.; Ceravolo, R.; Spano', Antonia. - In: INTERNATIONAL ARCHIVES OF THE PHOTOGRAMMETRY, REMOTE SENSING AND SPATIAL INFORMATION SCIENCES. - ISSN 1682-1750. - ELETTRONICO. - 43:B2-2022(2022), pp. 845-852. [10.5194/isprs-archives-XLIII-B2-2022-845-2022]

Availability:

This version is available at: 11583/2970422 since: 2022-11-25T20:51:19Z

Publisher:

Copernicus publications

Published

DOI:10.5194/isprs-archives-XLIII-B2-2022-845-2022

Terms of use:

This article is made available under terms and conditions as specified in the corresponding bibliographic description in the repository

Publisher copyright

(Article begins on next page)

3D MODELS AND NON-DESTRUCTIVE INVESTIGATIONS: TOWARDS A MEETING IN DIGITAL TWINS

G. Patrucco ¹, S. Perri ¹, G. Sammartano ¹, E. Fillia ¹, I. Matteini ², E. Lenticchia ², R. Ceravolo ², A. Spanò ^{1*}

¹ Department of Architecture and Design (DAD), Politecnico di Torino Viale Mattioli 39, 10125 Turin, Italy
(giacomo.patrucco, stefano.perri, giulia.sammartano, edoardo.fillia, antonia.spano)@polito.it

² Department of Structural, Geotechnical and Building Engineering (DISEG), Politecnico di Torino, Corso Duca degli Abruzzi 24,
10129 Turin, Italy, imattein@gmail.com, (erica.lenticchia, rosario.ceravolo)@polito.it

Commission II, WG II/8

KEY WORDS: as-built modelling, Rapid mapping, LiDAR, MMS, SLAM, Non-destructive investigation, Structural Health Monitoring (SHM), Concrete Assessment, 20th century architectural heritage.

ABSTRACT:

The digitisation projects of architectural heritage are a field of research continuously evolving and updating in parallel to technological innovations that allow to progressively boost the challenges and requirements of geometric and semantic richness of the related digital configuration of results. Among the arduous tasks under observation, there is the increasing need to harmonize and make the spatial and heterogenous information aspects cooperating. This paper focuses on the procedures for structuring an information system based on the as-built modelling strategy applied on a particularly relevant example of reinforced concrete architecture, which presents the bearing structure of the structural elements featured by complex geometries and roofing conceived as ferrocement wavy elements and therefore equally unusual as a construction system. The entire project refers to a conservation plan that involves structural non-destructive investigations that inquiry the state of health of the structures and their seismic performance. The purpose is to structure a parametric system, based on HBIM technology, which enables the archiving of investigations and results in order to strengthen direct spatial reference between geometric elements and structural analysis results, based also on image and range-based surface analyses, in the direction of a digital twin of the architectural complex.

1. INTRODUCTION

The digitisation of architectural heritage is currently a relevant need in the framework of heritage conservation plans which typically make use of a complex set of investigations that need to be connected for boosting the complete knowledge of the heritage buildings, in a common purpose of protection and safeguarding. If the multi-disciplinary approach, together with the consideration that all the activities of inspection and monitoring should be documented and kept as part of the history of the structure, is consolidated (ICOMOS 2003), today the pressure of accelerating the digitisation of architectural heritage, sites, and cultural artifacts for future generations is a part of a wider proposal of digital transition promoted at national and international level (EU Commission, Italian PNR).

In this context, the outcomes of the 3D survey, that exploits innovative image- and range-based techniques, are multi-scale and multi-content 3D models. These digital products are considered a fundamental step as they represent the basis for the generation of enriched 3D models, structured with the support of metadata, as a system for the data management. At the same time, the complex of non-destructive investigation techniques, that analyses the state of health of the structures, is equally important in the foreshadowed data management system (Yi et al. 2011)

In the general purpose of evaluating built heritage conditions using close-range sensing techniques, overviews on metric surveying and from recording techniques that are traditionally non-metric – such as thermography and multispectral imaging – are available (Adamopoulos & Rinaudo, 2021) and innumerable experiences on literature associate the typical structural engineering investigations with updated reality based techniques

focusing on the advantages of point clouds managing for different purposes (Funari et al., 2021).

The awareness that the precise geometry detection of the studied structures can provide an important contribution in the diagnosis phase to assess buildings health, has led to a real alliance between traditionally investigation techniques related to structural engineering and sensing techniques, with their comparison and integration in a holistic sense (Jiang et al. 2008, Xu et al. 2018). Generally, the 20th century architectural heritage and, particularly, the assets related to the modern movement, present certain construction techniques and materials due to the completely new spatial conception (wide span, thin shell) (ICOMOS 2017). For these reasons a particular accuracy is required in the determination of the geometric morphology and possible anomalies: it is crucial to carry out a careful evaluation of the structural performances, addressing particular attention to the level of safety in static conditions and considering the point of view of seismic behaviour. Starting from a vast collection of investigations carried out in the main halls of The Turin Exhibition Centre designed by P. Nervi, the famous and complex example of 20th century industrial legacy, in order to determine the safety level, as part of the conservation plan project, the paper aims to present the researches and the tests carried out to combine the results of multi-temporal structural investigations in the form of a user-oriented 3D model, that can be conceived as a digital twin.

1.1 The Turin Exhibition Centre

The Turin Exhibition Centre is an urban complex where the Pavilions B and C, designed by Pier Luigi Nervi in the half of

* Corresponding author

20th century, are hosted. The exceptional structures were conceived and realized by Nervi with ferrocement technique, using on-site precast elements combined with in-situ concrete. Here a multidisciplinary approach is ongoing thanks to the “Keeping it Modern” project – Planning Grant 2019 promoted by the Getty Foundation, in which the research group is involved. The aim of the general research work is the development of a conservation plan (CP), through the condition assessment and diagnosis of the hall’s structures, finalized to the preservation, retrofit and re-use (Ceravolo et al. 2020), considering the digitization phase a challenging task and a first step in the multi-expertise data gathering conducted in the pavilions. (Sammartano et al. 2021)

As other projects (Diacodimitri et. al, 2022), the conservation plans enhancing historical and architectural values are expected to draft guidelines for Modern Movement Heritage.

In particular, one of the specific purposes of the present study is to confirm the suitability of photogrammetric and TLS techniques for accurate and dense detection of the surfaces for metric digitization of large buildings. These approaches are quite independent of the shape of the structural elements and construction systems, but are greatly influenced by the materials and the general configurations of the spaces, especially if they are wide and articulated, and therefore they require challenging strategies to maintain the single reference system and manage huge amounts of data. The even more challenging phase, if possible, is the one which concerns the as-built modelling phase (Abbate et al. 2020), since the vaulted spaces are made up of structural elements based on complex geometries freely conceived in space through double curved surfaces.

2. 3D MODELS AND STRUCTURAL INVESTIGATION

2.1 3D models from reality-based survey

The 3D models have been generated and optimized for data integration purposes in the proposed digital twin following the strategies described in this paper. The external building envelope is mainly derived from UAV photogrammetric techniques, while as regards the indoor survey numerous techniques have been integrated for data merging. The internal spaces have been measured with the following different range- and image-based survey techniques:

- traditional terrestrial laser scanning (TLS) techniques (using phase shift laser scanners Faro Focus^{3D} X 330 and Faro Focus^{3D} S120, accuracy ± 2 mm @ 10 m), which allowed the acquisition of 110 scans and more than 4 billion points.

- two different SLAM-based hybrid systems for mobile mapping have been employed. The first one is the hand-held scanner (the ZEB-Revo RT system). Thanks to the flexibility of this kind of movable device (Otero et al. 2020) it was possible to acquire the ancillary spaces (such as corridors, stairs and the rooms on the sides of the pavilions, together with the underground floor) which would have been challenging and time-consuming to acquire with traditional static scanning systems. Such secondary spaces survey has been crucial to understand and document entire spatial configuration of the great inclined pillars of hall B in its three-floors development, since they are mainly incorporated in partition walls system.

Additionally, the new Swift System from Faro technologies has been tested in this framework. This MMS (Mobile Mapping System) is equipped with a traditional Faro scanner and a profilometer (through which the positioning SLAM-based function operates) both mounted on a mobile trolley. The main advantage of this solution is represented by the possibility to achieve a high resolution and high precision point cloud – comparable to the ones acquired with static TLS techniques –

with the rapidity of acquisition and flexibility of MMS solutions (Bonfanti et al. 2021).

- Close-range digital photogrammetry. In the case of the presented research, very high-scale focuses have been carried out using a close-range photogrammetric approach in order to document – in a multi-temporal perspective – the analyses and investigations conducted by the different research teams, allowing the collection of high-resolution data (both in terms of spatial resolution and radiometry), characterised by a millimetre-level accuracy.

In the framework of architectural structures such as the vaulted systems made by Nervi, the structural engineering investigation requires high accurate point clouds for 3D surface reconstruction, but at the same time a balanced density of information and an adequate level of detail. The 3D model processing, starting from the accuracy validation and the registration of the data derived from different techniques, aims to obtain a unique point cloud model that accurately describes the thin elements that distinguish the vaults so as the general morphological characters of the building (Bonfanti et al., 2021). In other words, according to this objective, the 3D model has to describe a proper general configuration of the building and a precise geometry of the structural elements must be carefully harmonized, in order to provide the capability to highlight and analyse deformations and anomalies as well as to ensure data usability and interoperability (Moyano et al. 2022).

2.2 Diagnostic investigations: focus on georadar investigations and potential maps applied on inclined pillars.

With the aim to finalize an exhaustive characterization of the materials and structures, the estimation of the type and number of necessary tests was defined on the basis of preliminary assessments and in relation to the construction phases of the work, the static role of the various structural elements, their function with regard to safety the structure and the degree of homogeneity of the results of any preliminary tests.

The structural elements have been identified and classified, in order to govern the evaluations of each component of the vast modular system (Fig. 1).

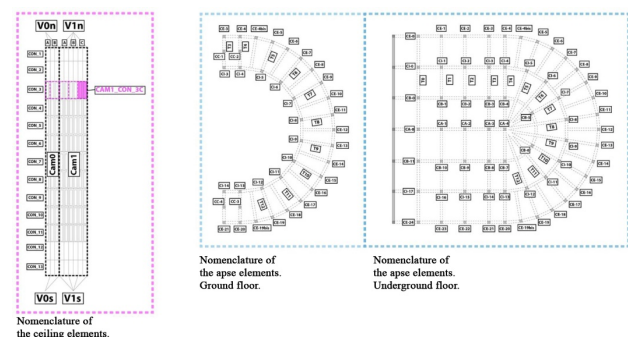

Figure 1. Classification and nomenclature scheme of the modular elements composing the Hall B.

Among very different types of investigations conducted there are: (a) Determination of the sclerometer index; b) Ultrasonic tests; c) Internal temperature and humidity monitoring; d) Environmental Temperature Monitoring; e) Coring; f) Determination of carbonation depth; g) Compression tests on extracted concrete samples; h) Tests for the determination of the elastic modulus on the extracted concrete samples; i) Thermographs; j) Corrosion Testing. The ones that will be focused in the current paper are: (k) Survey of the reinforcements by georadar; (m) Mapping of the corrosion potential in some samples of inclined pillars of Pavillion B.

The choice to report only some examples of structural test results is due to the opportunity to highlight the results of these surveys in reference to their spatial distribution, which is possible thanks to the chance of correlating them from the overall 3D model of the structures.

The great inclined pillars are element cast in place in four different phases; their main structural function is to transmit the structural loads from the vault to the foundation. In order to optimize this functionality, Nervi decided to create inclined monolithic elements with an increasing cross section towards the foundations, in such a way as to be stressed mostly with axial compressive forces and to ensure that the resultant of the loads remained in the middle third of the foundation.

The reinforcement of the pillar elements, called P12n, was investigated by partial scarification, which made it possible to measure the diameter of the reinforcements using a calibre; furthermore, a survey using ground penetrating radar has been carried out to understand the steel reinforcement configuration and to verify the correspondence with the original design of Pier Luigi Nervi (Fig. 2).

Additionally, corrosion potential testing has been performed on a series of structural elements distributed across the structure. The corrosion potential on the south side was performed on 3 pillars on the first floor, and 2 pillars on the ground floor. Over 90% of the data collected at these elements shows a 90% probability of absence of corrosion in accordance with ASTM C876-15 Standard Test Method for Corrosion Potentials of Uncoated Reinforcing Steel in Concrete (Tab. 1). This was also confirmed by the measurements of the internal temperature and humidity collected on the P7 pillar on the first floor where an average humidity of $\leq 65\%$ was detected. This confirms a dry condition inside the pillar. The presence of a layer of plaster (on average 1.5-2 cm thick) over time protected these elements by the ingress of humidity and external contaminants.

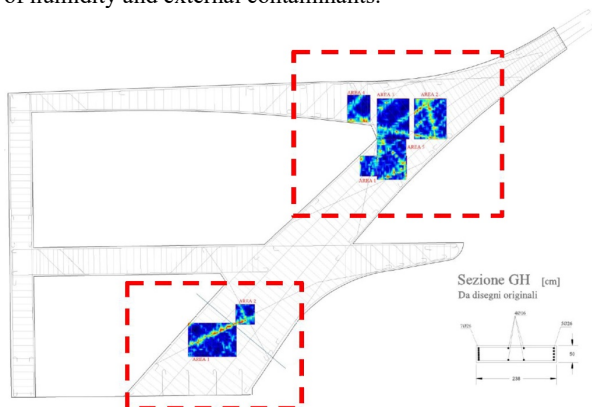

Figure 2. Overlapping of the reinforcement detected by georadar with respect to the reinforcement as it was designed by Pier Luigi Nervi.

Statistical Analysis Corrosion Potential (south side)							
w.r.t. Cu/CuSO4	Millivolts		Percentage				
	Min	Max	PT-P13S %	P1-P13S %	PT-7S %	P1-P7S %	P1-P4S %
(A)	< -200		100%	97%	100%	98%	98%
(B)	-200	-350	0%	3%	0%	2%	2%
(C)	> -350		0%	0%	0%	0%	0%
	Tot.		100%	100%	100%	100%	100%

Table 1. Statistical analysis of the corrosion potential. (A) Probability of 90% of absence of corrosion activity, (B) Uncertain, (C) Probability of 90% of presence of corrosion activity.

The columns in the basement have a different condition than the elements on the upper levels. The collected potential measurements show negative values at the base due to rising damp and an average probability of the presence of corrosion activity. In particular, corrosion at the base of the reinforcements with the presence of detachment of the concrete is visible.

3. OVERALL INTERPRETATION OF THE BUILDING AND GEOMETRIC ANOMALIES DETECTION.

As discussed, the single reference system, that allows to manage in a single point cloud and a unified set of correlated information, has the fundamental and precious role to compare different investigations and heterogeneous results with each other. At the same time, it provides the possibility to correlate the spatial configuration of the structural elements and the related anomalies and deteriorations at the different levels of the building. In Figure 3 the precise overlapping of different floors plans can be observed, enabling to analyse the actual configuration of the structural elements and possible decay behaviour at all factory levels (2D comparison are possible as well as 3D merging of different three-dimensional surfaces).

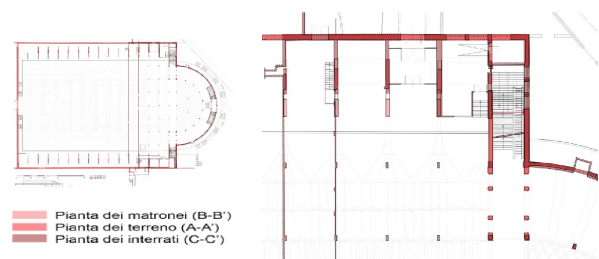

Figure 3. Overlay of architectural drawings based on topographical reference of the underground, ground and galleries levels of the building (a) overall (b) excerpt.

As regards the inclined pillars of the Hall B, a 3D model – representing the different pillars and the reinforcement irons within them – has been generated using the original Pier Luigi Nervi’s design drawing as reference. This model has been registered to the reality-based data – in this case LiDAR point clouds – to perform a comparison. The pillar which has been considered for this analysis is the twelfth in the northern row of the P12 module. It has been chosen since it was one of the most investigated structures of the Hall B (georadar acquisitions; potential analyses; thermal investigations, etc.). Because of the existence of several discrepancies between the two models, due to the changes occurred to the original plan during the construction stage, an ICP-based (Iterative Closest Point) strategy would result in an erroneous registration due to the different morphology and geometries of the two models. For this reason, a set of homologous points – unambiguously identified in both the 3D model generated from original drawings and the LiDAR point clouds – has been used as reference to align the two models (Fig. 4). This operation was relatively complex considering that the two models are slightly different, even in areas difficultly detectable by a simple visual inspection. Additionally, one side of the pillar is incorporated in a curtain wall. However, it was possible to identify 9 reference points to carry out the target-based registration. This procedure is particularly useful to compare the pillar conceived during the design stage and the one actually built; additionally, it allows to analyse the Nervi’s scheme of reinforcement irons in connection with the reality-based model (Fig. 5).

As it is possible to observe in Figure 6, the performed discrepancies analysis – which has been carried out in the 3DReshaper platform – has evidenced several significant

deviations from the 3D reconstruction and the reality-based model. This lack of correspondence is also confirmed by the Georadar analyses carried out (Figure 2) – performed on the same P12n pillar considered for this comparison – which have evidenced some differences between the reinforcement of the concrete scheme by Nervi's drawings and the structure of thin iron reinforcements actually realised.

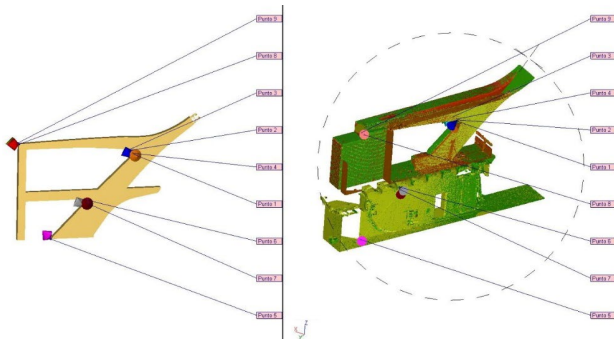

Figure 4. Registration between the 3D model (achieved from the original Nervi's design drawings) and the LiDAR point cloud.

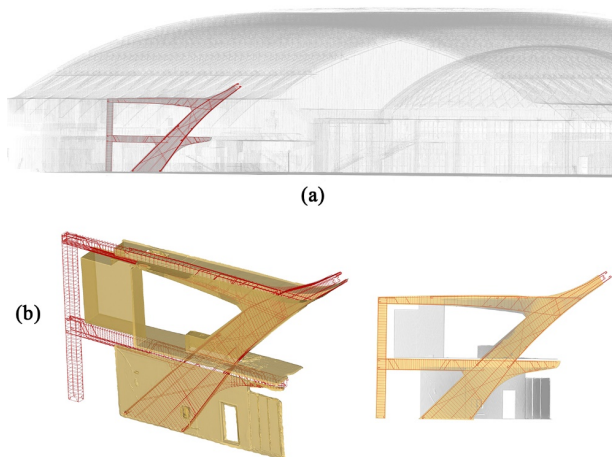

Figure 5. (a) Integration of the extrados of the P12 pillar module surveyed by reality-based model. (b) 3D models of the internal structural elements developed from the design phase.

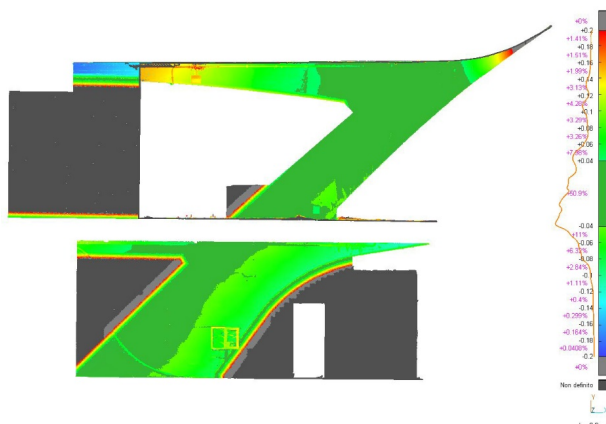

Figure 6. Discrepancies analyses between the 3D model from Nervi's drawings and the LiDAR point clouds after the co-registration.

This analysis allows to accurately track and evaluate the variance between the original project and the real constructive solution which

has been adopted in the construction phases. This possibility is particularly useful to ensure the highest precision during the tests, the analyses, and the structural simulations, in order to guarantee an adequate accuracy and the lower deviation from the actual scenario. Additionally, these digital strategies based on reality-based data acquisition and modelling enable to detect and quantify possible deformations or anomalies, through an accurate monitoring of the surveyed surfaces. E.g., starting from the point clouds acquired with the techniques described in the previous sections, it was possible to carry out a precise monitoring of the geometries and the shapes of the different elements composing the surveyed halls. For example, in the case of the SAP vault (reinforced concrete-brick) placed in the Hall B (between the ribbed dome of the apse and the curling vault of the main room), it was possible to compare the section of the vault with the primitive generating geometry (a circle with a 28.88 m radius) in order to evaluate the curvature differences. The deviation from the section performed on the reality-based model and the interpolated circle is around 3.5-4 cm (Fig. 7d), which can be considered almost insignificant since the huge size of the vault.

Also, the deformations have been analysed, starting from the point cloud model, to detect any unexpected anomaly. As it is possible to observe in Figure 7b, from the isocurves – extracted from the mesh automatically interpolated from the LiDAR point cloud – a possible deformation is evident on the upper part (presumably an adjustment occurred during the construction). This is also confirmed by the slope analysis reported in the Figure 7c.

Furthermore, as far as the thin curling ferroement covering is concerned, the high precision topographical network together with the robust pipeline managing the cloud registration and optimisation have enabled to estimate the average value of the ferroement element by a series of control measures on the intrados and extrados surface. Such result was 7.4 cm with a standard deviation of 1.2 cm, i.e. that are perfectly consistent and coherent with Nervi's original project (Fig. 8).

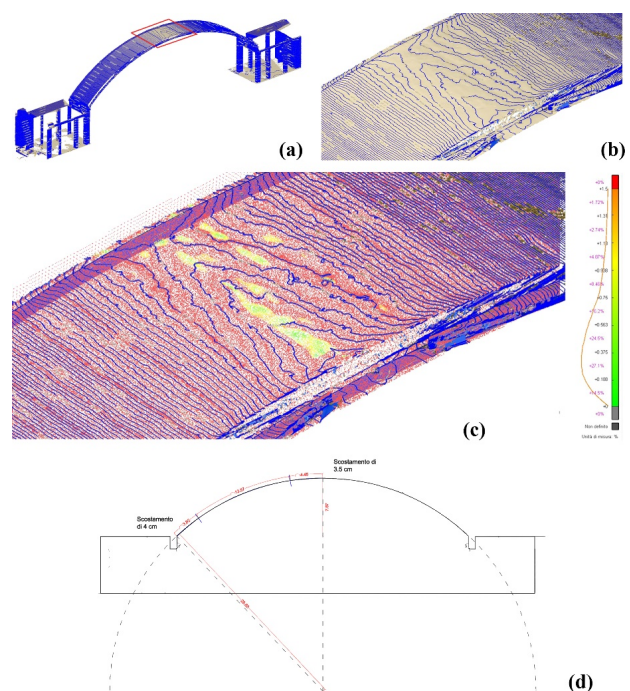

Figure 7. (a) 3D model of the arch with isocurves; (b) zoom on the upper part of the arch (isocurves evidencing the anomaly); (c) slope analysis performed on the LiDAR point cloud confirming the isocurves shape anomaly; (d) Scheme representing the deviation between the vault and the generating geometry.

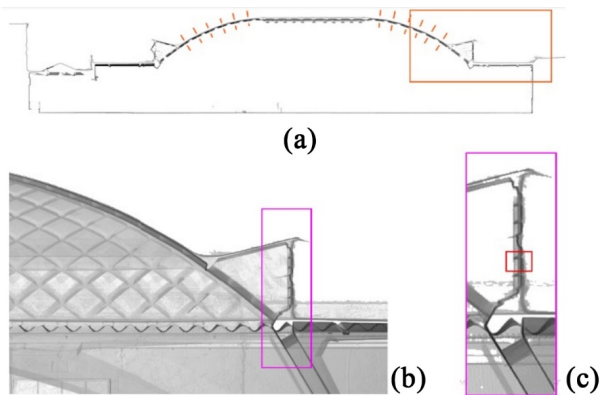

Figure 8. Longitudinal section of the integrated 3D model (LiDAR+UAV) (a), with a zoomed view (b) of the vaulted system node and the perimeter skylights (b).

4. 3D MODELLING AND INTEGRATION OF HIGH MULTIDISCIPLINARY INFORMATION CONTENTS

4.1 3D model processing to enable digital archives

The possibilities offered by the non-destructive analyses and monitoring techniques, allowing to achieve precise and accurate results for an efficient and effective built heritage documentation, have been focused and discussed in the previous section. Now a further reflexion should be made about the necessity to spatially connect the highly interdisciplinary studies that have always accompanied valorisation and conservation projects.

In particular, in the case presented in the current paper, a 3D model – in the meaning of a Digital Twin – should provide the possibility of comparing the spatial configuration of the structural elements and the related anomalies and deteriorations at the different levels of the building. Additionally, one of the main aims of the research, connected to the conservation plan, is represented by the opportunity to spatially relate the performed diagnostic analyses in a single digital 3D archive, in order to provide a spatial and semantic structure for the multidisciplinary and interdisciplinary investigations.

For this reason, with the purpose of planning the integration of multi-source information contents, NURBS-based 3D objects have been generated. As reported in Sammartano et al. 2021, the modelling operations involved not only the structures and the geometries of the considered pavilions, but also the analyses performed by each research unit and the investigated surfaces, with the aim to establish a spatial connection among the performed examinations. For this reason, the modelling operations have been carried out both to model the architectural and structural elements belonging to the pavilion and to represent the elements of interest from the structural point of view: for example, internal structural element objects (Fig. 5), crack pattern, position of the diagnostic investigations carried out, location of the sensors used for these investigations, exposed iron, peeling of plaster, etc. For this purpose, a careful classification of the spatial references of the carried-out analyses, in the form of surfaces, linear or punctual entities, have been performed (Fig. 13).

As regards both the two surveyed halls, an as-build modelling strategy has been followed, in order to: i) optimise/topologize the unstructured primary data (point clouds/polygonal model) and to ii) generate 3D surfaces and volumes suitable for information hosting with the aim to structure a digital archive containing the analysis and the results of the carried out diagnostic investigations, in a HBIM-oriented perspective. (Brumana et al. 2018)

Different strategies have been followed. On one side, complex surfaces (e.g. double-curved concrete surfaces as the Hall C pillars) have been modelled by means of profiles extrusion using advanced modelling tools implemented in the well-known 3D modelling platform Rhinoceros (loft, sweep, patch, etc.). The profiles have been extracted from a high-resolution surface model (3D mesh) interpolated from the original point cloud (by means of Delaunay triangulation), in order to automatically extract continuous profiles which enable the achievement of very accurate surfaces (the deviation between the final NURBS model surfaces and the original point cloud, used as reference to determine the acceptability of the performed simplification, is from a few millimeters to 4-5 centimeters, and it is therefore coherent with a 1:100/1:200 scale of representation) (Fig. 9 -12).

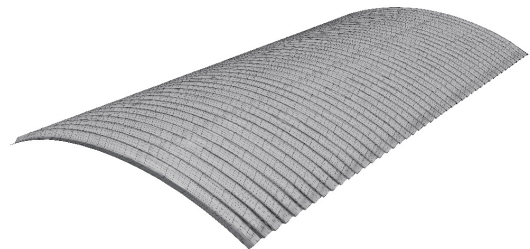

Figure 9. NURBS model of the Hall B vault, modelled following an as-built strategy.

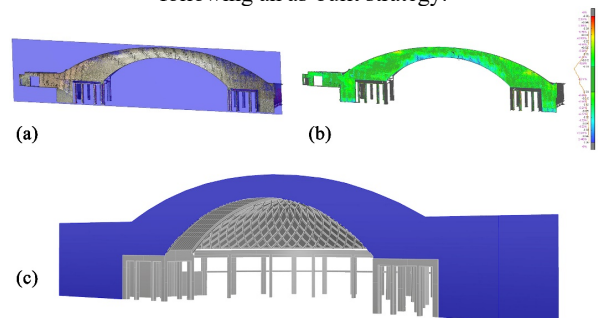

Figure 10. (a) Best-fitting plane (least-squares interpolation). (b) Discrepancies analysis between the generated plane and the primary data (point cloud). (c) NURBS modelling.

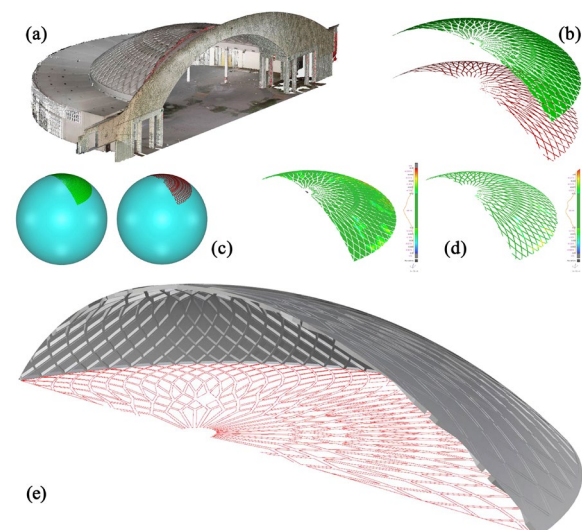

Figure 11. (a) LiDAR point cloud (Hall B apse and dome); (b) Segmented point cloud (dome and ribs intrados). (c) Best-fitting spheres (least squares interpolation); (d) Discrepancies analyses between the interpolated spheres and the original point cloud; (e) NURBS modelling.

Another modelling strategy for the generation of NURBS-based surfaces is represented by least-squares estimation of planes (vertical walls, partitions, ceilings, etc.) or geometric primitives (e.g. such as spheres, in the case of the dome placed in the apse of the Hall B) directly from the point cloud, accurately verifying the discrepancies between the interpolated geometry and the primary data.

An important aspect connected to these modelling procedures that should be underlined regards the constant metric control by the operator. At every stage of the NURBS surfaces generation a deviation analysis has been performed to evaluate the difference between the original model and the optimised model in terms of metric accuracy. On one hand, this approach allows a constant monitoring on the acceptability of the optimisation pipeline, in connection with the pre-established goals of the modelling procedures; on the other hand, it enables the detection of possible anomalies (e.g. off-axis walls, deformed architectural surfaces, elements which deviate from the generating primitive geometries, etc.). (Figure 10). For example, in the case of the apse of the Hall B, this approach has underlined the good condition of the dome in terms of geometric shape.

As it is possible to observe in Figure 11, the dome has been segmented to classify the intrados of the support ribs and the points belonging to the spheric dome using a semi-automatic curvature-based procedure. For both classes of points a best-fitting sphere has been interpolated to be used as reference surfaces for the subsequent NURBS modelling.

However, from the discrepancies analyses between the segmented point clouds and the interpolated spheres, two aspects deserve attention. The first one regards the low deviation between the extracted geometries and the original point clouds, as can be observed in figure 11 d. (in the first case, the 88.1% of the points deviate less than ± 2 cm; as regards the second sphere, the percentage is 92.3%).

In the second case, a low eccentricity of the two spheres can be observed. In fact, comparing the two theoretically concentric spheres – with a radius of 28.84 m and 28.59 m respectively – and, in particular, focusing on the shift between the two central points, it is possible to evidence a shift of 2.8 cm, which can be considered almost insignificant, especially taking into account the considerable size of the analysed dome and the onsite casting construction mode. (Figure 11, b, c).

The combination of these details induces to confirm that the dome is under good conditions by a geometric/morphologic point of view.

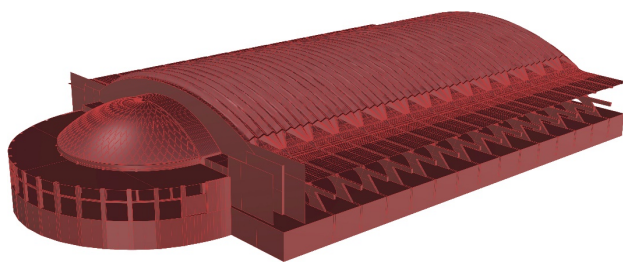

Figure 12. Preliminary NURBS model of the pavilion B modelled following the described as-built strategies.

4.2 Stratifying information: interdisciplinary data integration

Another relevant aspect of this research is related to a correct reading of the analysed building and structures in a transversal way, considering both the information and the metric contents. Many of the analyses performed in the framework of the non-invasive diagnostic investigations usually are not carried out with

a robust metric approach. Consequently, it becomes relevant to develop new and efficient strategies to implement, where possible, the opportunity to connect heterogeneous data and information, derived from heterogeneous sources.

One of the strategies which have been applied in the current research, as described in Section 1.1, has staked multitemporal close-range acquisitions that have been collected to efficiently record both decays and performed investigations (Fig. 13). In both cases, exploiting the high-resolution radiometry achievable from a close-range photogrammetric approach, it was possible to derive information (e.g., state of conservation, consistency of the material, colour scheme etc.) that it would be impossible to manage only starting by the geometries described by point clouds and modelled surfaces. Additionally, in this regard – heading toward the perspective of an implementation of non-invasive diagnostic investigations – the use of multispectral images non-visible range of electro-magnetic spectrum seems very promising for photogrammetric purposes, which represents a research area (Scaioni et al. 2017, Patrucco et al. 2021). In the course of this research, multispectral images have been collected evidencing interesting anomalies, particularly in the disposition of internal pillars in the pavilion C; this study will be developed in the next future. In the framework of the research project, a perspective of absolute interest is represented by the possibility of implementing these investigations and, possibly, evaluating how a photogrammetric approach could help in a documentation and decay classification perspective.

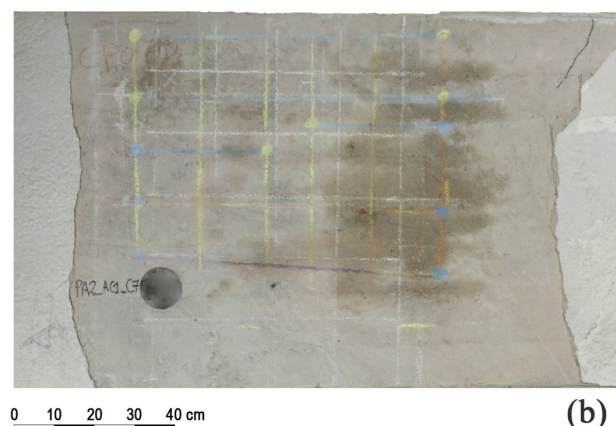

Figure 13. (a) High-resolution photogrammetric 3D model derived from very close-range acquisitions. (b) High-resolution orthoimagery (GSD < 1 mm) of one of the investigated areas.

Generally, the possibility to read non-spatial analyses in a three-dimensional space enable the opportunity to relate a multitude of factors, features and elements that are – usually – separately considered. For this reason, in order to enhance the interpretation of the obtained results and to enable a 3D visualisation of the analyses (e.g. potential maps, georadar analyses, ecc.) directly on the reality-based model, in this case a texture projection-based strategy has been followed. In Figure 14 it is possible to observe two corrosion potential maps projected on a reality-based 3D mesh derived from LiDAR point clouds. The maps have been projected using a set of homologous points unambiguously identified on the 3D model (e.g., edges and corners) derived from measurements directly acquired in the field, enabling the possibility to analyse the maps not only in connection with the spatial model, but also with the reinforcement irons scheme derived from the original design drawings (Fig. 15).

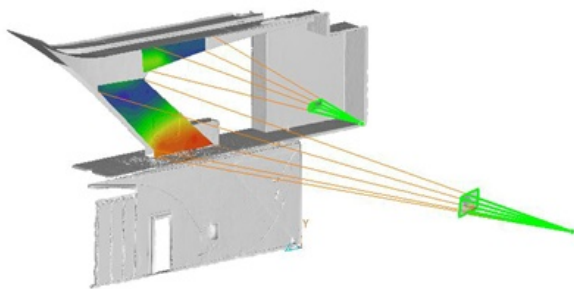

Figure 14. Projection of the corrosion potential map of the P12 pillar on the reality-based model (3D mesh).

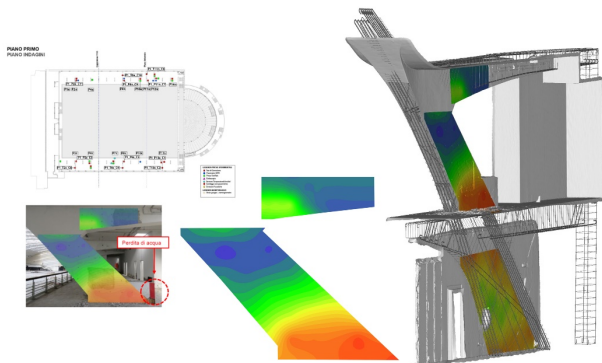

Figure 15. Corrosion potential map for one of the P12n pillar module, projected on the reality-based mesh; integration between the textured model and the irons reinforcement (modelled from the original Nervi's project drawings).

5. CONCLUSIONS AND FUTURE PERSPECTIVES: TOWARDS THE STRUCTURING OF A UNIQUE 3D ARCHIVE (HBIM)

Finally, one last consideration concerns the potentiality related to the development of a digital archive (HBIM) structured to host all the elements considered in the previous sections. In this case, the parametric paradigm is not only an approach to informative modelling, but it represents an interesting possibility to connect, manage and query the multi-source information in the related database. The intermediate results shown in this paper, achieved inside the on-going project work, aim to provide a demonstration the crucial role of the 3D spatial reference within a system that organizes structured information, which today we call digital twin. These enriched models represent an opportunity for experts

and researchers providing additional possibilities for interpreting the results of non-destructive investigations. At the same time the goal is to investigate the open issues related to the parameterization of objects that are complex and irregular by their own nature, as well as other aspects related to the modelling strategies, such as: resolution, level of simplification, data format, use and integration of standards based on CAD and IF. In addition to the overall modelling of the spaces and construction systems conceived by Nervi, the study demonstrates how the digitisation of the Turin exhibition complex required highly detailed insights that enrich the general framework and boost the most consolidated modeling procedures, bending them to the ferrocement morphologies of the modern architecture. That is due to respond to the need to identify characters and details to be examined in depth with interdisciplinary analysis, in order to contribute to the overall knowledge of the factory. All the observations in these paragraphs can address the characteristics and requirements of the information system based on a parametric paradigm that is supposed to represent an intelligent replica of the building. It is important to consider that the digital twins of the architectural organism must be configured not only as a geometric multiscale model based on an *as-built* strategy avoiding the regularization of the elements, but also as a multi-temporal platform to be updated not only in the presence of interventions on the factory, but also when the diagnostic investigations are stratified, with the aim to broaden the wealth of knowledge on the object. (Figure 16-17) Finally, the multi-content meaning is essential for the expert-oriented model, in order to be able to account for the different points of view that have analysed the same objects and phenomena and that have seen and highlighted multiple and multifaceted results.

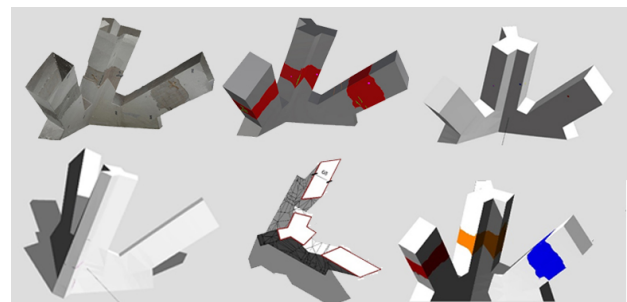

Figure 16. As-built modelling for NURBS generation and implementation of HBIM 3D model (integration with the structural analyses carried out during the investigation phase).

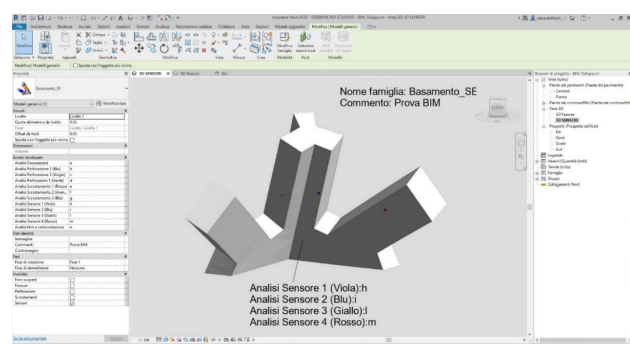

Figure 17. South-eastern basement of the pillars of the pavilion C, modelled in the Rhinoceros platform and implemented in a BIM environment (the adopted platform is Autodesk Revit).

ACKNOWLEDGEMENTS

In addition to the Getty Foundation grant, the Municipality of Turin significantly contributed to the conservation plan and related activities with a financial support, dispensed by the contracting authority SCR Piemonte. The general planning of the study has also been shared with the protective authority.

REFERENCES

- Abbate, E., Invernizzi, S., Spanò, A., 2020. HBIM parametric modelling from clouds to perform structural analyses based on finite elements: a case study on a parabolic concrete vault. *Applied Geomatics*, 14, 79-96. <https://doi.org/10.1007/s12518-020-00341-4>
- Adamopoulos, E., Rinaudo, F., 2021. Close-Range Sensing and Data Fusion for Built Heritage Inspection and Monitoring – A Review. *Remote Sensing*, 13(19), 3936. <https://doi.org/10.3390/rs13193936>
- Bonfanti, C., Patrucco, G., Perri, S., Sammartano, G., & Spanò, A., 2021. A new indoor LiDAR-based MMS challenging complex architectural environments. *Int. Arch. Photogramm. Remote Sens. Spatial Inf. Sci.*, XLVI-M-1-2021, 79–86. <https://doi.org/10.5194/isprs-archives-XLVI-M-1-2021-79-2021>
- Brumana, R., Della Torre, S., Previtali, M. et al. 2018, Generative HBIM modelling to embody complexity (LOD, LOG, LOA, LOI): surveying, preservation, site intervention—the Basilica di Collemaggio (L'Aquila). *Appl Geomat* 10, 545–567. <https://doi.org/10.1007/s12518-018-0233-3>
- Ceravolo, R., De Lucia, G., Lenticchia, E., Miraglia, G., Quattrone, A., Tondolo, F., Matta, E., Sammartano, A., Spanò, G., Chiorino, C., Bruschi, G., Faccio, P., Nanni, A., 2020. Challenges in the reuse and upgrade of Pier Luigi Nervi's structures. *Proceedings of SAHC 2020 - 12th International Conference on Structural Analysis of Historical Constructions*, 1-11. <https://doi.org/10.23967/sahc.2021.043>
- Diacodimitri, A., Giodice, M., Romeo, F., Balsi, M., 2022. Developing Critical Knowledge of Twentieth-Century Cultural Heritage via Massive Survey: The Case of the Conservation Plan of the Stadio Flaminio in Rome. In C. Bartolomei, C., Ippolito, A., Vizioli, S. H. T., (Eds.), *Digital Modernism Heritage Lexicon*, Springer International Publishing, 1291-1317. https://doi.org/10.1007/978-3-030-76239-1_57
- Funari, M. F., Hajjat, A. E., Masciotta, M. G., Oliveira, D. V., Lourenço, P. B., 2021. A Parametric Scan-to-FEM Framework for the Digital Twin Generation of Historic Masonry Structures. *Sustainability*, 13(19), 11088. <https://doi.org/10.3390/su131911088>
- ICOMOS, 2022. The Cádiz Document: InnovaConcrete Guidelines for Conservation of Concrete Heritage. https://isc20c.icomos.org/policy_items/complete-innovaconcrete/
- ICOMOS, 2017. ISC20C, Approaches to the conservation of Twentieth-century cultural heritage Madrid – New Delhi Document. <http://www.icomos-isc20c.org/madrid-document/>
- ICOMOS, 2003. ICOMOS Charter – Principles for the analysis, conservation and structural restoration of architectural heritage (2003). https://www.icomos.org/charters/structures_e.pdf
- R. Jiang, D. V. Jáuregui, White, K. R., 2008. Close-range photogrammetry applications in bridge measurement: literature review, *Measurement*, 41(8), 823–834. <https://doi.org/10.1016/j.measurement.2007.12.005>
- Moyano, J, Gil-Arizón, I., Nieto-Julián, E., Marín-García, D., 2022. Analysis and management of structural deformations through parametric models and HBIM workflow in architectural heritage. *Journal of Building Engineering*, 45, 103274. <https://doi.org/10.1016/j.measurement.2007.12.005>
- Otero, R., Lagüela, S., Garrido, I., Arias, P., 2020. Mobile indoor mapping technologies: A review. *Automation in Construction*, 120, 103399. <https://doi.org/10.1016/j.autcon.2020.103399>
- Patrucco, G., Cortese, G., Giulio Tonolo, F., Spanò, A., 2020a. Thermal and optical data fusion supporting built heritage analyses. *Int. Arch. Photogramm. Remote Sens. Spatial Inf. Sci.*, XLIII-B3-2020, 619-626. <https://doi.org/10.5194/isprs-archives-XLIII-B3-2020-619-2020>
- PNR, Programma nazionale per la ricerca 2021-2027, Ministero dell'Università e della Ricerca, Programma nazionale per la ricerca 2021-2027 – Patrimonio culturale. <https://www.mur.gov.it/sites/default/files/2021-01/Pnr2021-27.pdf>
- Sammartano, G., Patrucco, G., Perri, S., Ceravolo, R., Lenticchia, E., Spanò, A., 2021. Documenting complexity for the 20th century heritage: the enriched 3D models of the Turin Exposition Nervi's halls digitization. *ISPRS Ann. Photogramm. Remote Sens. Spatial Inf. Sci.*, VIII-M-1-2021, 141-148. <https://doi.org/10.5194/isprs-archives-XLIII-B3-2020-619-2020>
- Scaioni, M., Rosina, E., L'Erario, A., Diaz-Vilariño, L., 2017. Integration of infrared thermography and photogrammetric surveying of built landscape. *Int. Arch. Photogramm. Remote Sens. Spatial Inf. Sci.*, XLII-5/W1, 153–160. <https://doi.org/10.5194/isprs-archives-XLII-5-W1-153-2017>
- Shaping Europe's digital future. <https://digital-strategy.ec.europa.eu/en>
- Yi, T.-H., Li, H.-N., Gu, M., 2011. Optimal sensor placement for structural health monitoring based on multiple optimization strategies. *The Structural Design of Tall and Special Buildings*, 20(7), 881–900. <https://doi.org/10.1002/tal.712>
- Xu, X., Bureick, J., Yang, H., Neumann, I., 2018. TLS-based composite structure deformation analysis validated with laser tracker. *Composite Structures*, 202, 60–65. <https://doi.org/10.1016/j.compstruct.2017.10.015>