

POLITECNICO DI TORINO
Repository ISTITUZIONALE

Riuso del patrimonio oversize. Un progetto adattivo per la Cittadella di Alessandria // Oversized heritage reuse. An adaptive project for the Citadel of Alessandria

Original

Riuso del patrimonio oversize. Un progetto adattivo per la Cittadella di Alessandria // Oversized heritage reuse. An adaptive project for the Citadel of Alessandria / Vigliocco, Elena. - STAMPA. - (2021), pp. 1-201.

Availability:

This version is available at: 11583/2934520 since: 2021-10-28T11:30:48Z

Publisher:

Politecnico di Torino

Published

DOI:

Terms of use:

This article is made available under terms and conditions as specified in the corresponding bibliographic description in the repository

Publisher copyright

(Article begins on next page)

1. ingresso da Porta Reale // Porta Reale entrance

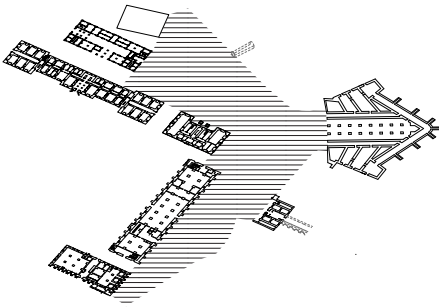

descrizione // description

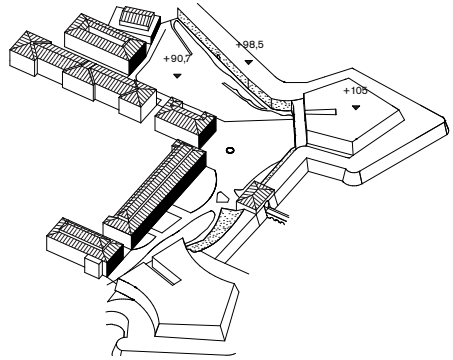

volumi e altimetrie // volumes and altimetries

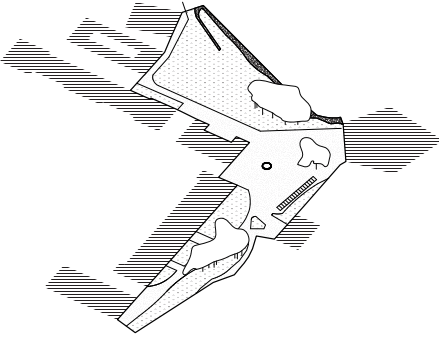

materiali // materials

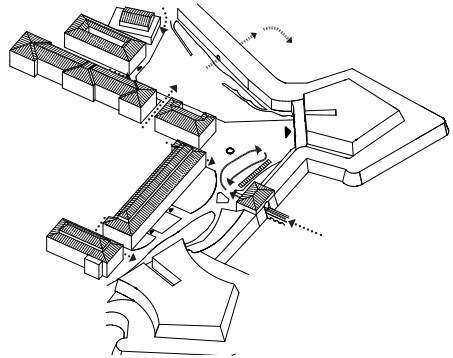

accessibilità // accessibility

superficie asfaltata /
asphalt surface

prato /
meadow

▶ ingresso edifici /
entrance of the buildings

.....▶ percorso pedonale /
pedestrian path

↑ percorso carrabile /
car path

.....▶ accessibilità potenziale /
potential accessibility

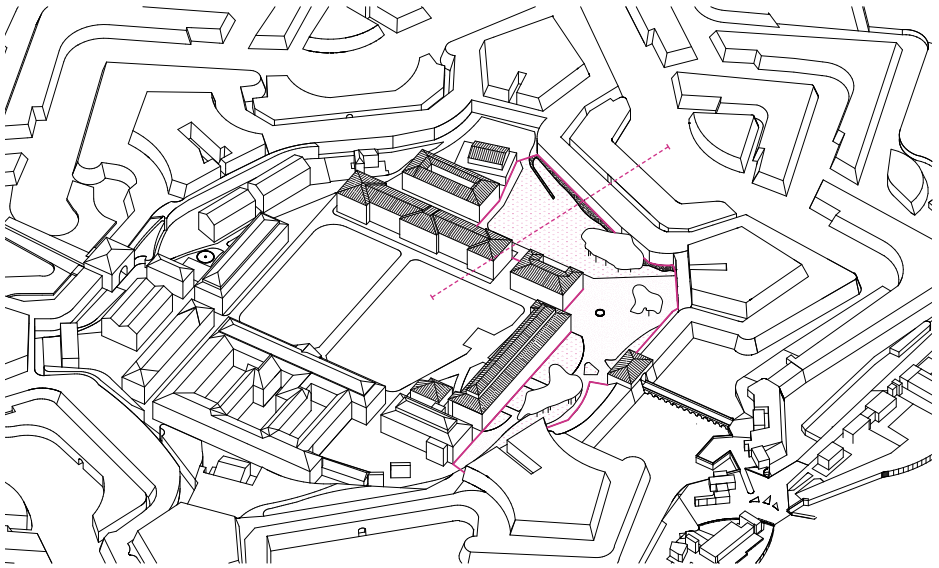

- segnalatica /
/ signage
- servizi igienici /
/ restrooms
- raccolta differenziata /
/ recycling
- integrazione luce-paesaggio /
/ integration landscape-light
- rampa di accesso /
/ access ramp
- pedane /
/ podiums
- arredo urbano fisso /
/ fixed street furniture



- ① ② ⑤ manutenzione verde e scarpate /
/ greenery and escarpments maintenance
- ③ manutenzione e/o sostituzione pavimentazioni esterne /
/ maintenance and/or replacement of external flooring
- ⑥ riapertura e manutenzione tunnel e ponti esistenti /
/ reopening and maintenance of existing tunnels and bridges



indicazione dei principali interventi e dei dispositivi utilizzati // indication of the main interventions and devices

2. Piazza d'Armi /

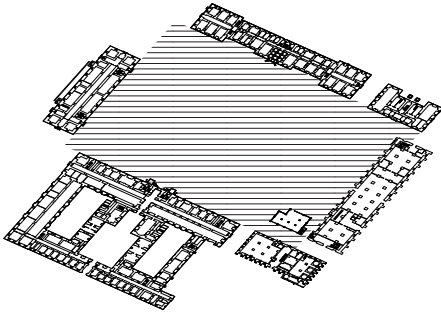

descrizione // description

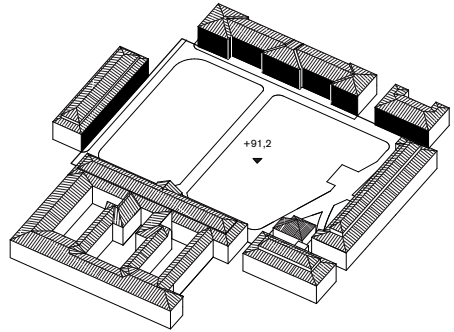

volumi e altimetrie // volumes and altimetries

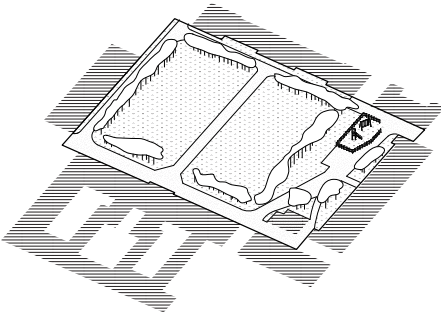

materiali // materials

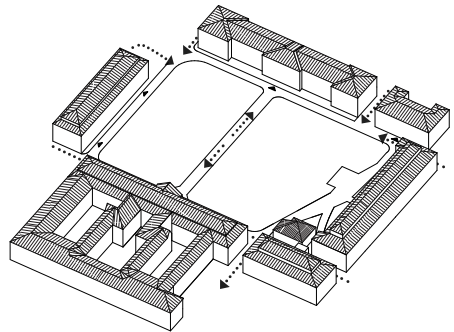

accessibilità // accessibility

superficie asfaltata /
/ asphalt surface

prato /
/ meadow

▶ ingresso edifici /
/ entrance of the buildings

.....▶ percorso pedonale /
/ pedestrian path

↑ percorso carrabile /
/ car path

.....▶ accessibilità potenziale /
/ potential accessibility

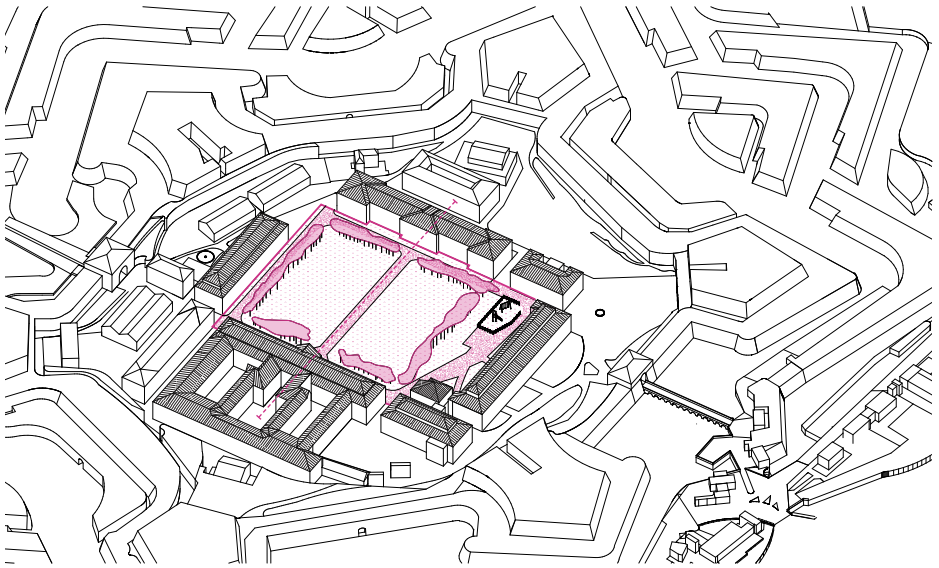

- segnalatica /
/ signage
- servizi igienici /
/ restrooms
- raccolta differenziata /
/ recycling
- integrazione luce-paesaggio /
/ integration landscape-light
- rampa di accesso /
/ access ramp
- pedane /
/ podiums
- arredo urbano mobile /
/ street furniture
- dehor /
/ dehor
- panchine /
/ benches
- giochi pubblici /
/ public games
- tendalino /
/ shelter



- ① ② ⑤ manutenzione verde e
scarpate /
/ greenery and
escarpments maintenance
- ③ manutenzione e/o sostituzione
pavimentazioni esterne/
/ maintenance and/or
replacement of external flooring
- ⑥ riapertura e manutenzione
tunnel e ponti esistenti /
/ reopening and maintenance
of existing tunnels and bridges



indicazione dei principali interventi e dei dispositivi utilizzati // indication of the main interventions and devices

3. ingresso da Porta del Soccorso // Porta del Soccorso entrance

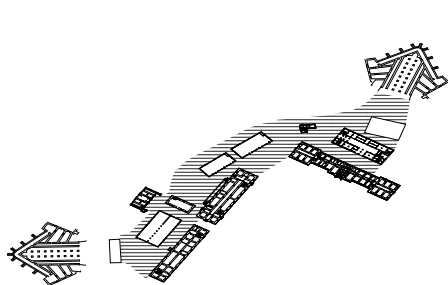

descrizione // description

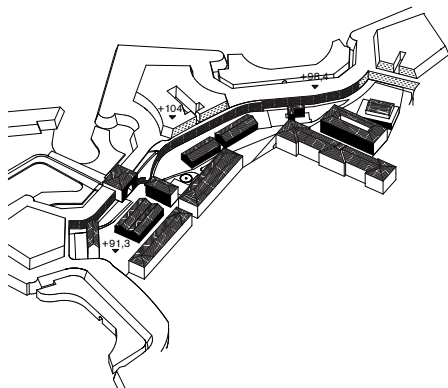

volumi e altimetrie // volumes and altimetries

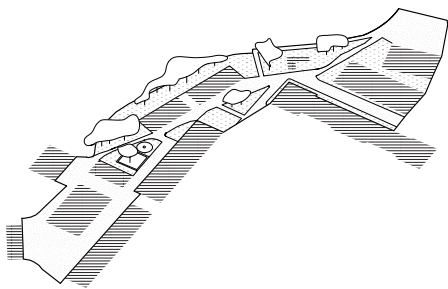

materiali // materials

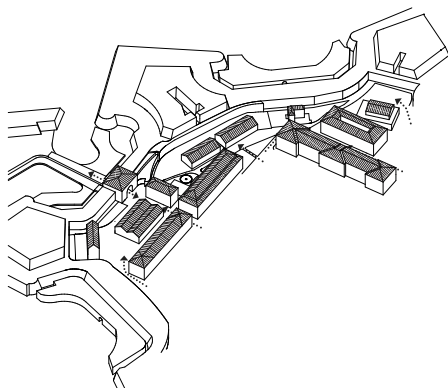

accessibilità // accessibility

superficie asfaltata /
/ asphalt surface

prato /
/ meadow

▶ ingresso edifici /
/ entrance of the buildings

.....▶ percorso pedonale /
/ pedestrian path

↑ percorso carrabile /
/ car path

.....▶ accessibilità potenziale /
/ potential accessibility

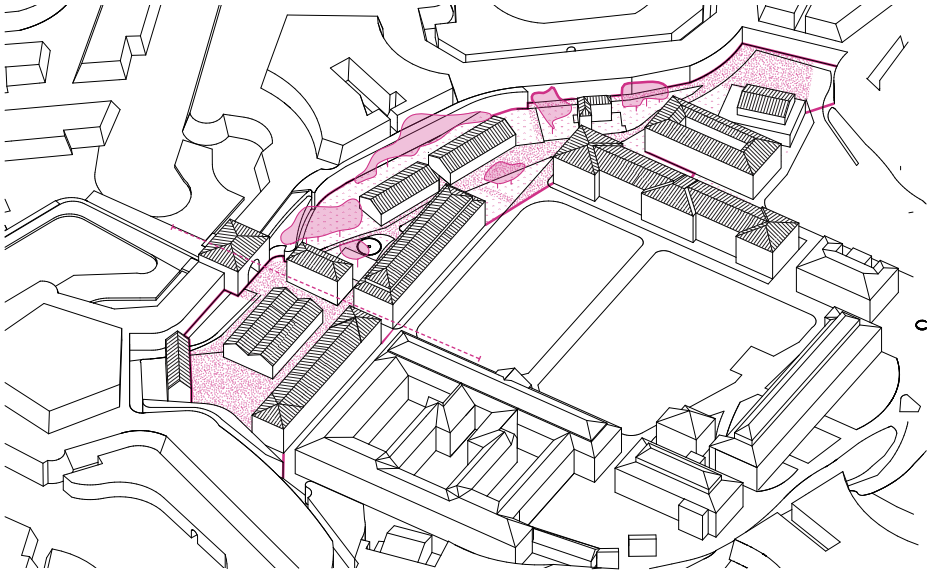

- segnalatica /
/ signage
- servizi igienici /
/ restrooms
- raccolta differenziata /
/ recycling
- integrazione luce-paesaggio /
/ integration landscape-light
- rampa di accesso /
/ access ramp
- pedane /
/ podiums
- arredo urbano mobile /
/ street furniture
- alberature /
/ trees
- cesate cantiere /
/ bulkhead
- transenne /
/ barricade

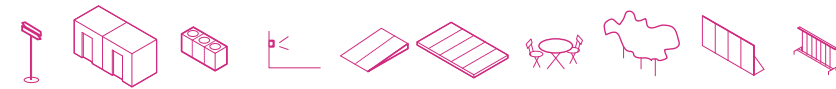

- ① ② ⑤ manutenzione verde e scarpate /
/ greenery and escarpments maintenance
- ③ manutenzione e/o sostituzione pavimentazioni esterne /
/ maintenance and/or replacement of external flooring
- ⑥ riapertura e manutenzione tunnel e ponti esistenti /
/ reopening and maintenance of existing tunnels and bridges

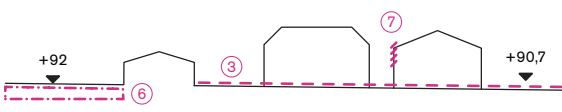

indicazione dei principali interventi e dei dispositivi utilizzati // indication of the main interventions and devices

4. bastioni San Tommaso e San Michele / / San Tommaso and San Michele bastions

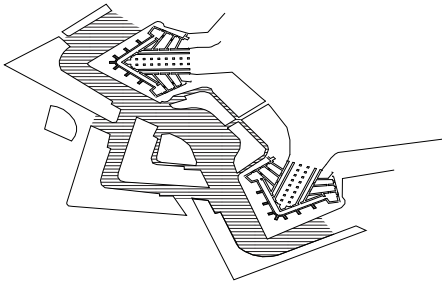

descrizione // description

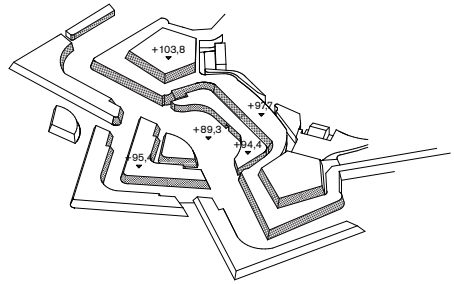

volumi e altimetrie // volumes and altimetries

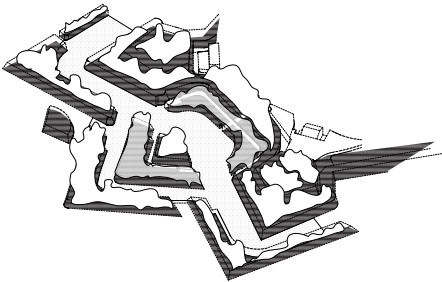

materiali // materials

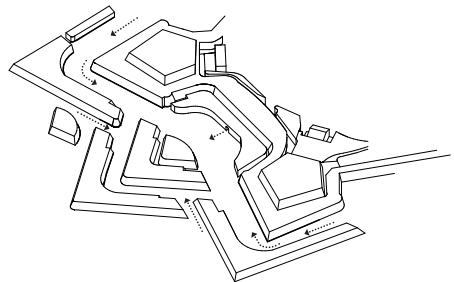

accessibilità // accessibility

.....
prato /
/ meadow

▶ ingresso edifici /
/ entrance of the buildings

.....▶
percorso pedonale /
/ pedestrian path

↑
percorso carrabile /
/ car path

.....▶
accessibilità potenziale /
/ potential accessibility

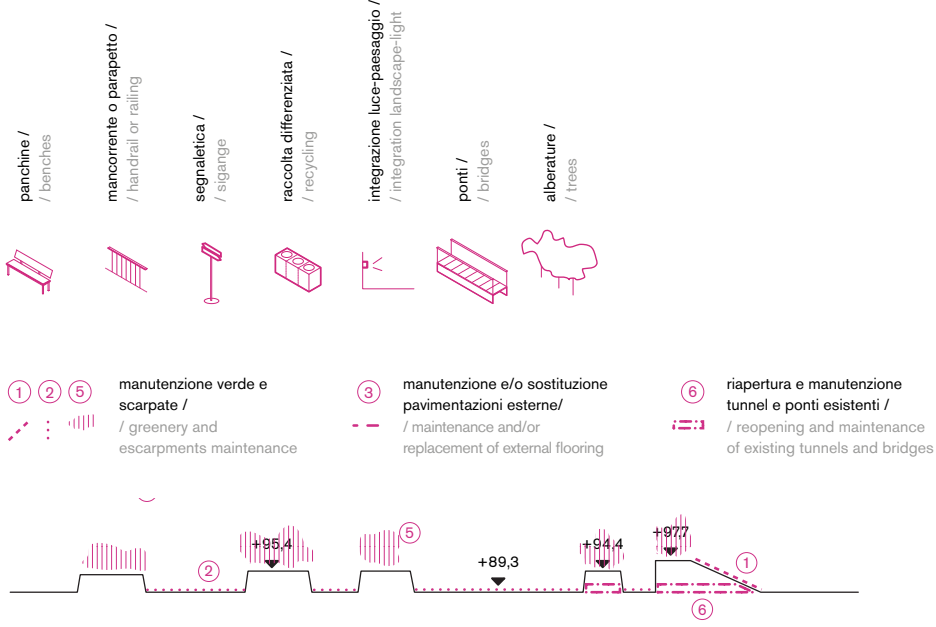
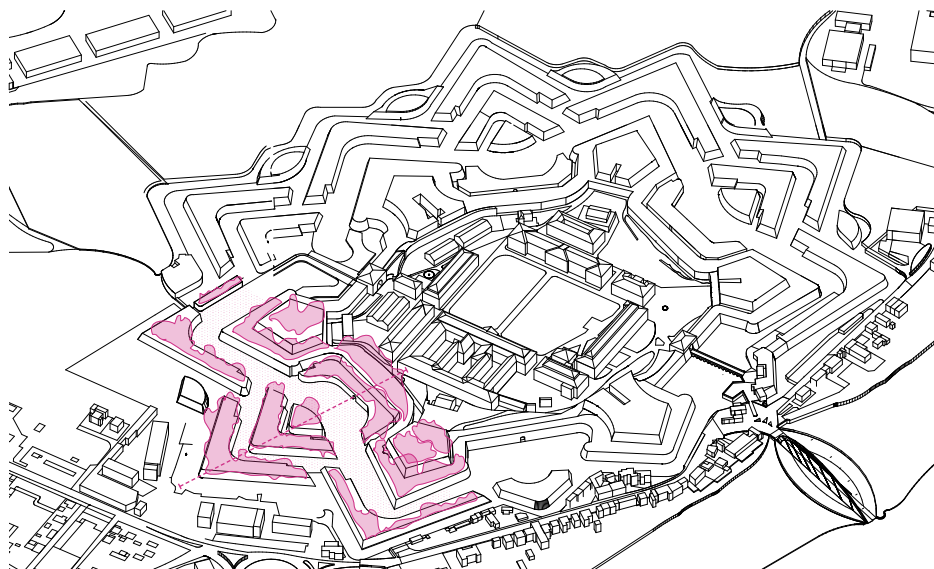

indicazione dei principali interventi e dei dispositivi utilizzati // indication of the main interventions and devices

5. tra bastioni San Michele e Santa Cristina / / between San Michele and Santa Cristina bastions

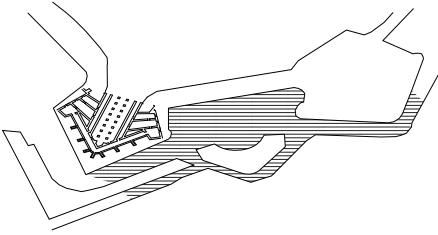

descrizione // description

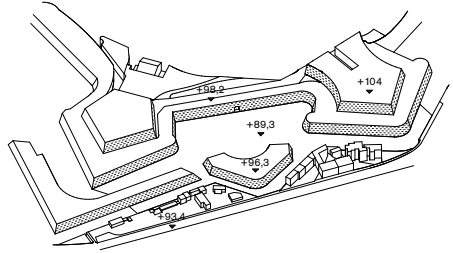

volumi e altimetrie // volumes and altimetries

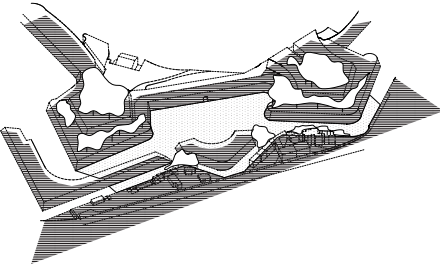

materiali // materials

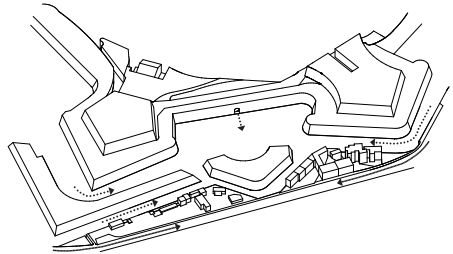

accessibilità // accessibility

.....
prato /
/ meadow

▶ ingresso edifici /
/ entrance of the buildings

.....▶
percorso pedonale /
/ pedestrian path

↑
percorso carrabile /
/ car path

.....▶
accessibilità potenziale /
/ potential accessibility

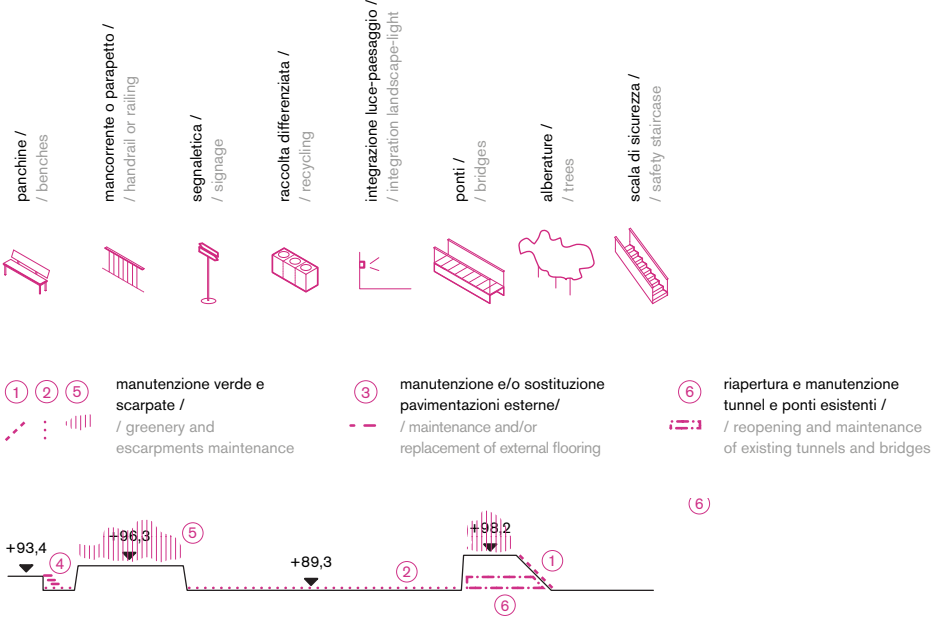
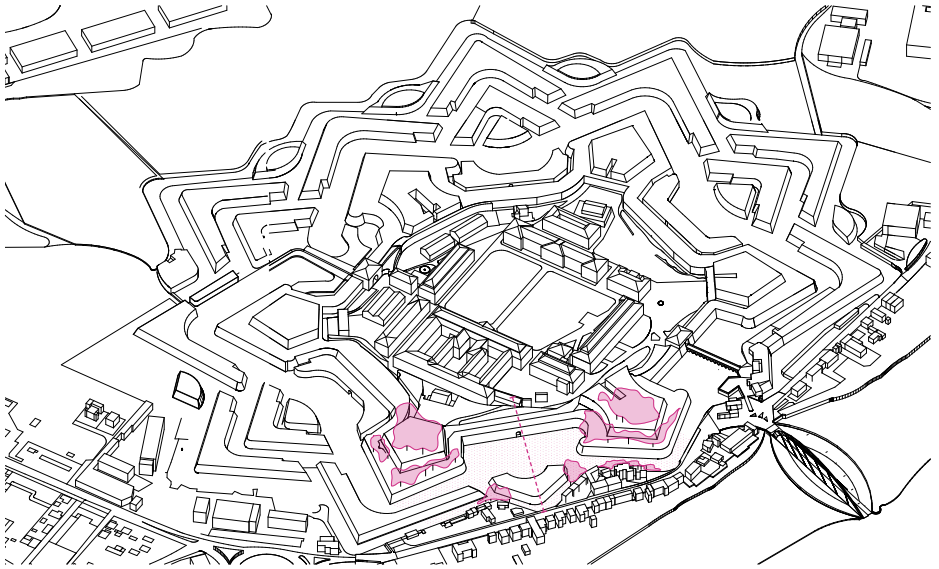

indicazione dei principali interventi e dei dispositivi utilizzati // indication of the main interventions and devices

6. tra bastioni Santa Cristina e Santa Barbara/ / Santa Cristina and Santa Barbara bastions

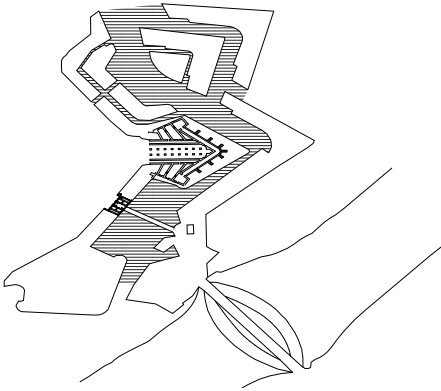

descrizione // description

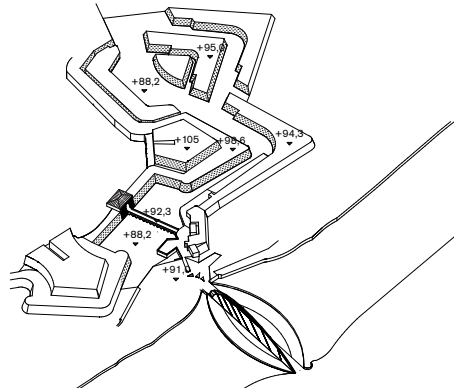

volumi e altimetrie // volumes and altimetries

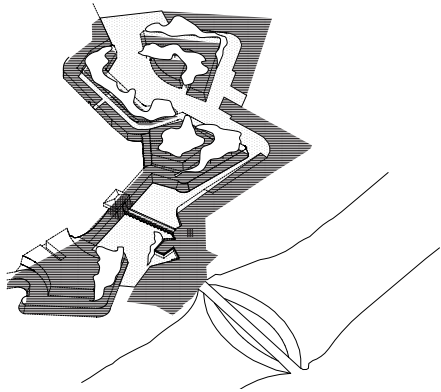

materiali // materials

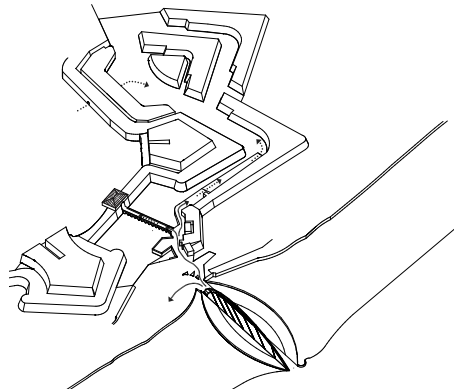

accessibilità // accessibility

.....
prato /
/ meadow









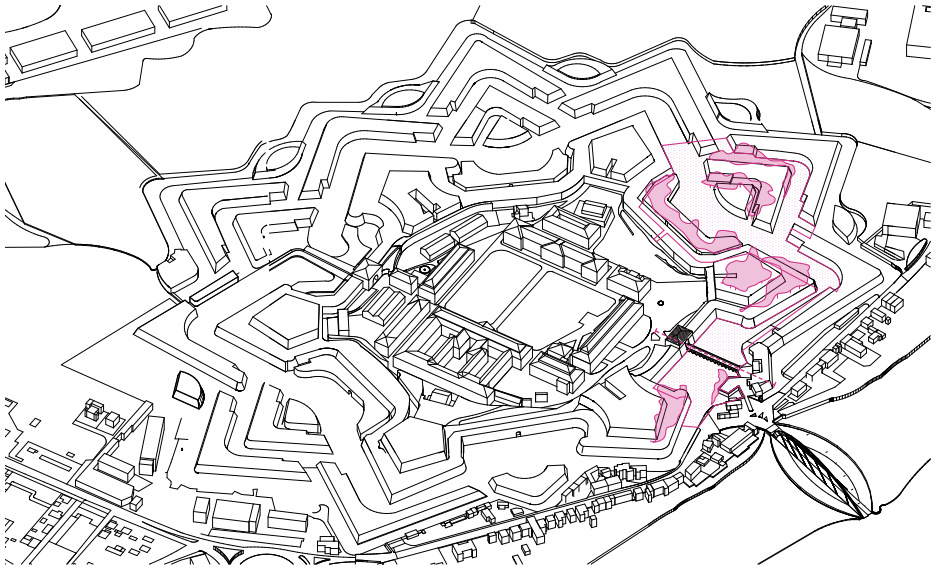



▶ ingresso edifici /
/ entrance of the buildings

.....▶ percorso pedonale /
/ pedestrian path

↑ percorso carrabile /
/ car path

.....▶ accessibilità potenziale /
/ potential accessibility



- | | | | | | | | | |
|--|---|---|---|--|--|---|--|---|
| <p>panchine /
/ benches</p>  | <p>mancorrente o parapetto /
/ handrail or railing</p>  | <p>segnaletica /
/ signage</p>  | <p>raccolta differenziata /
/ recycling</p>  | <p>integrazione luce-paesaggio /
/ integration landscape-light</p>  | <p>ponti /
/ bridges</p>  | <p>alberature /
/ trees</p>  | <p>scala di sicurezza /
/ safety staircase</p>  | <p>rampa di accesso /
/ access ramp</p>  |
| <p>① ② ⑤ manutenzione verde e scarpate /
/ greenery and escarpments maintenance</p>  | <p>③ manutenzione e/o sostituzione pavimentazioni esterne /
/ maintenance and/or replacement of external flooring</p>  | <p>⑥ riapertura e manutenzione tunnel e ponti esistenti /
/ reopening and maintenance of existing tunnels and bridges</p>  | | | | | | |

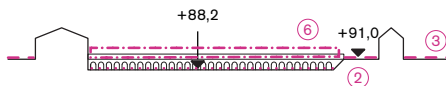

indicazione dei principali interventi e dei dispositivi utilizzati // indication of the main interventions and devices

7. tra bastioni San Antonio e San Carlo / / between San Antonio and San Carlo bastions

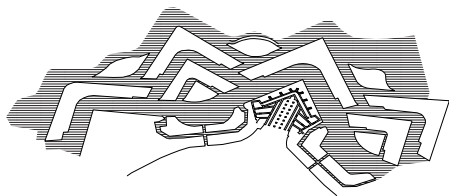

descrizione // description

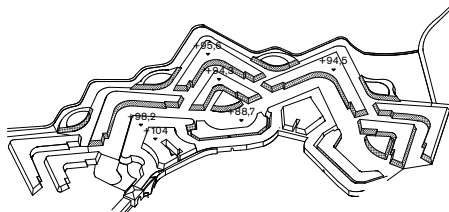

volumi e altimetrie // volumes and altimetries



materiali // materials

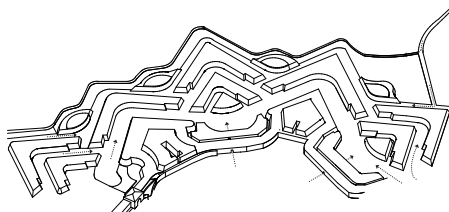

accessibilità // accessibility

.....
prato /
/ meadow

▶ ingresso edifici /
/ entrance of the buildings

.....▶
percorso pedonale /
/ pedestrian path

↑
percorso carrabile /
/ car path

.....▶
accessibilità potenziale /
/ potential accessibility

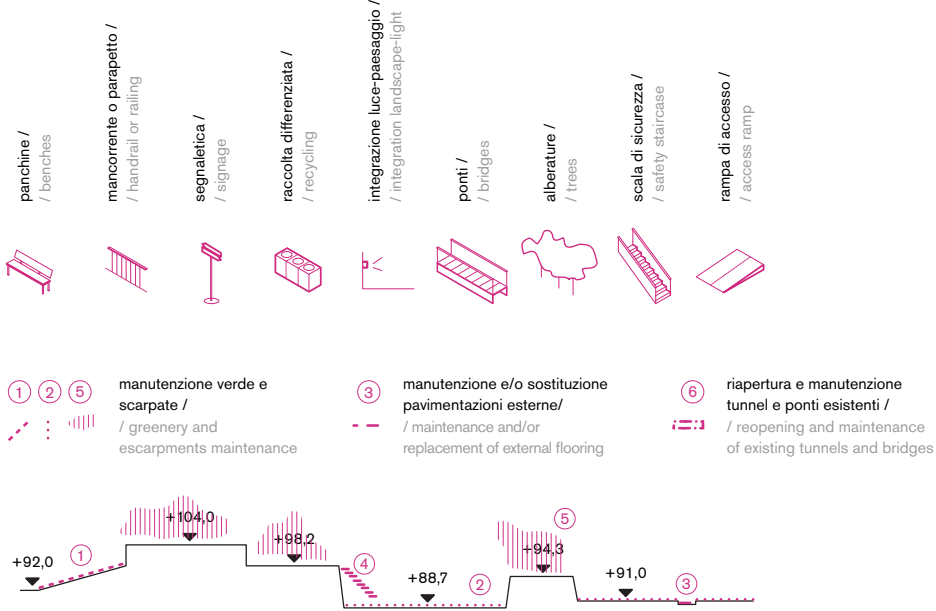
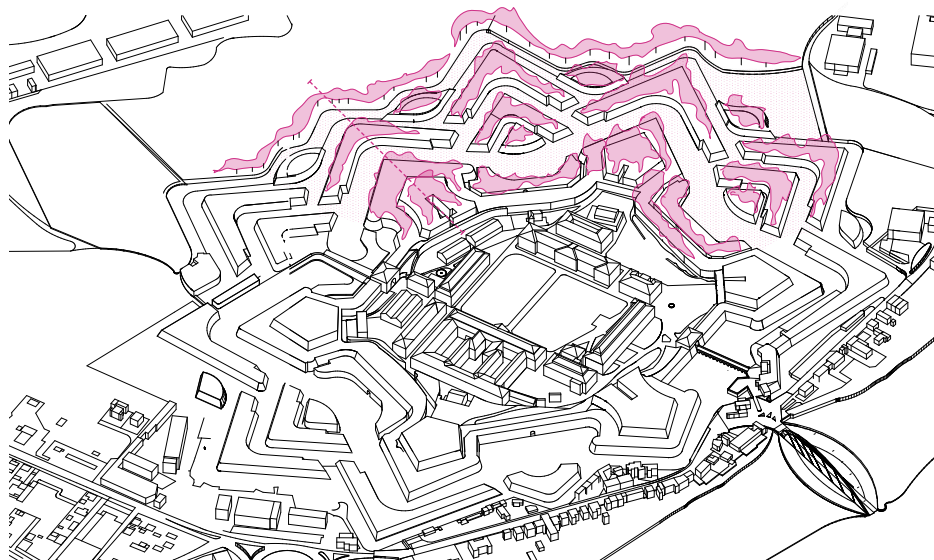

indicazione dei principali interventi e dei dispositivi utilizzati // indication of the main interventions and devices

8. tra bastioni San Carlo e San Tommaso/ / San Carlo and San Tommaso ramparts

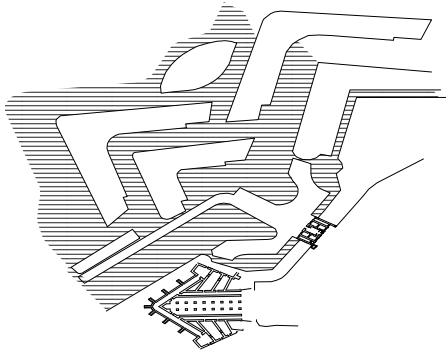

descrizione // description

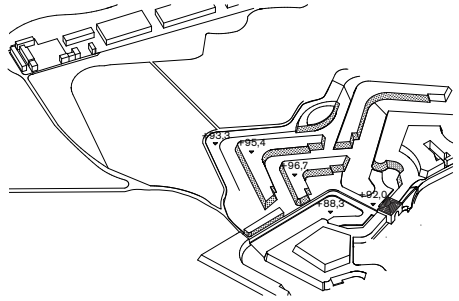

volumi e altimetrie // volumes and altimetries

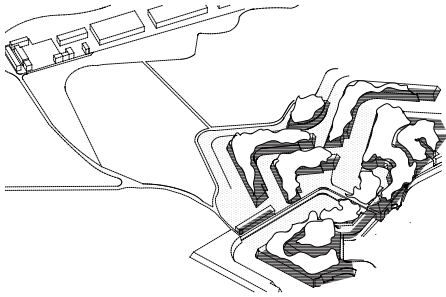

materiali // materials

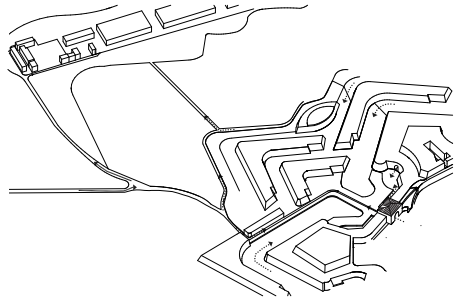

accessibilità // accesibility

.....
prato /
/ meadow

▶ ingresso edifici /
/ entrance of the buildings

.....▶
percorso pedonale /
/ pedestrian path

↑
percorso carrabile /
/ car path

.....▶
accessibilità potenziale /
/ potential accessibility

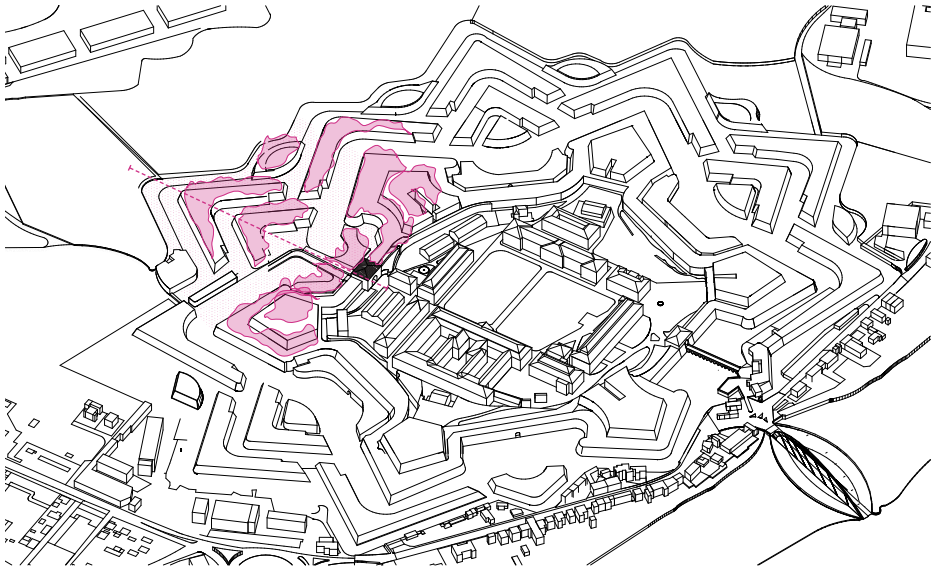

panchine /
/ benches



mancorrente o parapetto /
/ handrail or railing



segnaletica /
/ signage



raccolta differenziata /
/ recycling



integrazione luce-paesaggio /
/ integration landscape-light



ponti /
/ bridges



alberature /
/ trees



scala di sicurezza /
/ safety staircase



rampa di accesso /
/ access ramp



① ② ⑤



manutenzione verde e
scarpate /
/ greenery and
escarpments maintenance

③



manutenzione e/o sostituzione
pavimentazioni esterne/
/ maintenance and/or
replacement of external flooring

⑥



riapertura e manutenzione
tunnel e ponti esistenti /
/ reopening and maintenance
of existing tunnels and bridges

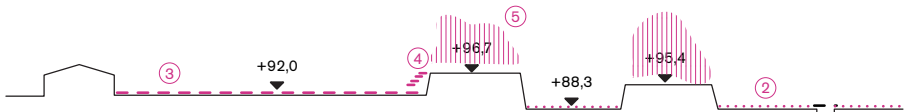

indicazione dei principali interventi e dei dispositivi utilizzati // indication of the main interventions and devices