

Broadband Electromagnetic Sensing for Food Quality Control: A Preliminary Experimental Study

*Original*

Broadband Electromagnetic Sensing for Food Quality Control: A Preliminary Experimental Study / Scapaticci, R.; Zappia, S.; Catapano, I.; Ruello, G.; Bellizzi, G.; Pasquino, N.; Cavagnaro, M.; Pisa, S.; PiuZZi, E.; Frezza, F.; Vipiana, F.; Tobon Vasquez, J. A.; Ricci, M.; Crocco, L.. - (2021), pp. 1-5. ( 15th European Conference on Antennas and Propagation, EuCAP 2021 deu 2021) [10.23919/EuCAP51087.2021.9411022].

*Availability:*

This version is available at: 11583/2907213 since: 2021-06-16T11:37:18Z

*Publisher:*

Institute of Electrical and Electronics Engineers Inc.

*Published*

DOI:10.23919/EuCAP51087.2021.9411022

*Terms of use:*

This article is made available under terms and conditions as specified in the corresponding bibliographic description in the repository

*Publisher copyright*

IEEE postprint/Author's Accepted Manuscript

©2021 IEEE. Personal use of this material is permitted. Permission from IEEE must be obtained for all other uses, in any current or future media, including reprinting/republishing this material for advertising or promotional purposes, creating new collecting works, for resale or lists, or reuse of any copyrighted component of this work in other works.

(Article begins on next page)

# Broadband Electromagnetic Sensing for Food Quality Control: A Preliminary Experimental Study

R. Scapaticci<sup>1</sup>, S. Zappia<sup>1,2</sup>, I. Catapano<sup>1</sup>, G. Ruello<sup>2</sup>, G. Bellizzi<sup>2</sup>, N. Pasquino<sup>2</sup>, M. Cavagnaro<sup>1,3</sup>, S. Pisa<sup>3</sup>, E. Piuze<sup>3</sup>, F. Frezza<sup>3</sup>, F. Vipiana<sup>4</sup>, J.A. Tobon Vasquez<sup>4</sup>, M. Ricci<sup>4</sup>, L. Crocco<sup>1</sup>

<sup>1</sup>Institute for the Electromagnetic Sensing of the Environment, CNR, Naples, Italy, crocco.l@irea.cnr.it

<sup>2</sup>Dept. of Electrical Eng. and Information Technology, “Federico II” University of Naples, Italy, giuseppe.ruello@unina.it

<sup>3</sup>DIET, Sapienza University of Rome, Rome, Italy, marta.cavagnaro@uniroma1.it

<sup>4</sup>Dept. of Electronics and Telecommunications, Politecnico di Torino, Torino, Italy, francesca.vipiana@polito.it

**Abstract**—Quality control is of great importance in food industry, both for the evaluation of product characteristics and to avoid the occurrence of foreign bodies contamination in packaged items. With respect to the inspections against possible contaminants inside the product, different technologies are currently adopted along production chain lines. However, the number of accidents involving low density objects remains very large. To overcome this limitation, the use of electromagnetic technologies has been recently proposed. In this work, the synergic use of terahertz and microwaves technologies is proposed, so to provide high resolution images and in-depth inspections of different scenarios, including low density materials. A focus study on sugar samples is considered, reporting both its broadband characterization at microwaves and preliminary terahertz imaging to evaluate the integrity of the packaging. Ongoing research is devoted to the development and validation of a microwave device for monitoring food products along the production line.

**Index Terms**— microwave imaging, microwave characterization, non-invasive diagnostics, food security, terahertz imaging.

## I. INTRODUCTION

In food industry, costumers’ complaint against manufacturers due to foreign body contamination, packaging failures, or items with poor characteristics (texture, appearance) is one of the main concern, which produces loss of brand loyalty and large recall expenses. For this reason, safety and quality of agri-food products have attracted significant attention worldwide. Various techniques have been developed in order to investigate foreign body contamination in food and packaging failures, ranging from X-ray imaging [1] to fluorescence imaging [2], among the others. However, the occurrence of incidents remains significant, since currently adopted technologies show some limitations, above all in detecting low density contaminants. Hence, the research towards novel technologies, possibly working in a complementary fashion with the existing ones, is still ongoing.

Based on the fact that electromagnetic (EM) properties of products depend on their characteristics (e.g., water content), EM sensing technologies are gaining a huge attention as an alternative and cost-effective option. However, besides specific technological challenges, when only a limited portion of the EM spectrum is considered, the overall requirements of agri-food quality control cannot be met. As a matter

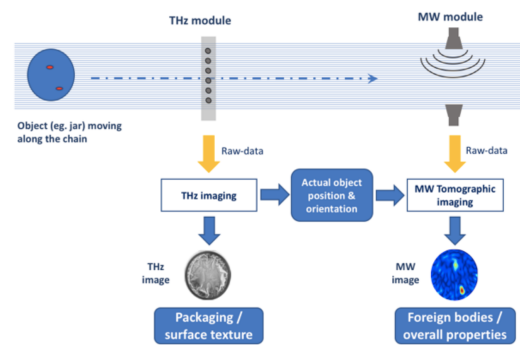

Fig. 1: Conceptual scheme of the EM technology for food monitoring.

of fact, at “low” frequencies (e.g., working at microwaves (MW), between few hundreds of MHz and tens of GHz) there are limitations in terms of spatial resolution, whereas higher frequencies (e.g., THz or optical frequencies) do not penetrate material bodies enough to inspect possible presence of contaminants.

The idea underlying this work, schematized in Fig.1, is to take advantage of the interplay between different portions of the electromagnetic spectrum, towards the development of an effective technology for food quality monitoring. The synergic use of terahertz and microwaves technologies is proposed, so to provide high resolution images and in-depth inspections. In particular, the target first passes through the THz module, which continuously scans the sample (from above, in reflection mode) to gather information on its packaging and surface texture by means of THz imaging. The THz module will also provide the exact position and orientation of the object on the trail. All these pieces of information are provided as an input to the MW module, which consists of a pair of antenna arrays placed on the two sides of the conveyor belt, which probe the target during motion, using both transmitted and reflected signals. By relying on the prior information on sample position, the MW device will provide a differential tomographic image of the target’s interior, with the aim of revealing the possible presence of foreign bodies, as well as

appraising its internal EM properties.

As far as microwaves are concerned, in the last years there has been an increasing interest concerning the potential of MW imaging for food quality and safety assessment [3], [4]. However, the (limited) literature available on this topic essentially deals with non-imaging devices [5]–[7].

Regarding terahertz technology, recent advancements in the development of compact, cost-effective and effective THz systems motivated a significant interest in exploiting THz waves as a non-destructive and safe inspection tool in several application contexts, among which agri-food industry. THz waves have been successfully used to detect both high-density (aluminum and granite pieces) and low-density (maggots and crickets) foreign bodies in different foods [8]. Moreover, THz spectroscopy combined with chemometric methods has allowed to determine antibiotics and harmful residues, to discriminate genetically modified organisms, and detect adulterations [9]. In addition, reduced-cost THz prototypes capable of fast scanning have been recently proposed and their effectiveness has been shown for dry food inspection [10]. Despite these significant examples, THz potential in food inspection is still at its early stage and far to be completely assessed. For instance, being THz waves strongly attenuated by water, their use for inspecting “wet” food is so far limited and still represents an open issue.

This paper presents a preliminary feasibility study aimed at assessing the joint use of MW and THz technologies to enable food quality monitoring. To this end, a case study of sugar pockets has been considered and a first broadband characterization of sugar has been performed. This preliminary step is necessary in order to understand the kind of contaminants which can be reliably detected by a MW technology.

Then, the possibility of detecting small defects in sugar packaging by means of THz technology has also been assessed. Ongoing work are aiming at developing the first MW system to monitor food products against foreign contaminants and results from a preliminary measurement campaign will be presented at the conference.

## II. MATERIAL AND METHODS

### A. Measurement of dielectric properties at microwave frequencies

Two experimental set-ups were used to measure the dielectric properties of food samples at microwave frequencies: the first one is based on the open-ended probe technique, the second one is based on a waveguide system. The open-ended probe technique reconstructs the dielectric properties of the material under test (MUT) from the measurement of the reflection coefficient of an open-ended coaxial probe inserted into or placed in contact to the MUT [11]. Accordingly, the experimental set-up is made by a vector network analyzer connected to the open-ended probe ( Fig. 2).

The procedure foresees the calibration of the set-up by the measurements of three known loads, i.e., open, short, and a well-characterized liquid usually represented by distilled water

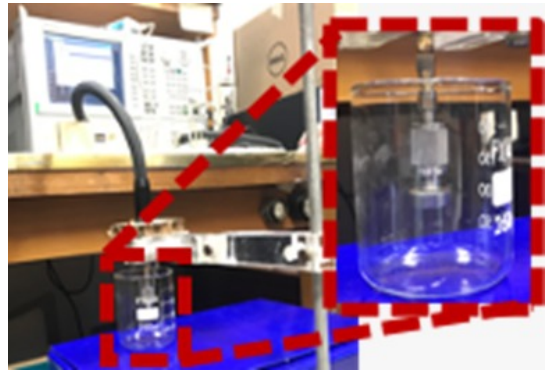

Fig. 2: Experimental set-up of the open-probe technique.

[12]. After calibration, the probe is placed in contact with the MUT and the measured reflection coefficient is used to reconstruct the dielectric properties.

In this study, the Agilent E8363C vector network analyzer was used; the coaxial probe was the High Temperature Probe available in the Keysight 85070E kit [13], and the reconstruction method was the one proposed in [11] and based on a lumped model of the open-ended probe [14], [15].

Open probe techniques are wide-band techniques, and are best suited for the measurement of liquids and semi-solid materials [11]; in addition, the High Temperature Probe having a large flange is proposed for the measurement of flat surfaced solid materials, also [13]. However, measurement of granular or powder materials, like sugar or flour, could induce additional errors for the presence of the air among the different granules of the material. Accordingly, to verify the accuracy of the measured data, measurements were also performed with a waveguide system. Waveguide measurements are based on a transmission/reflection approach, where the MUT is placed inside a suitable section of transmission line [11], [15]. In this study, a WR430 waveguide, spanning the 1.7–2.6 -GHz region, was used [15]. Fig. 3 shows the experimental set-up. Before the measurement, the calibration procedure foresees the measurement of the short connected at the two ports of the waveguide, the measurement of the thru and of the line, i.e. all the waveguide tracts placed in position as shown in Fig. 3. Then, the MUT is inserted in the waveguide line (section numbered 4 in figure 3) and the measurement is performed. Measurements were carried out using the Agilent E8363C vector network analyzer, equipped with Agilent 85071E permittivity measurement software [16]. The software provides different models to reconstruct the MUT dielectric properties. In particular, the Tran-Fast method was used.

### B. Measurement at Terahertz frequencies

The Fiber - Coupled Terahertz Time Domain (FiCO) system developed by Z-Omega and available at CNR-IREA is equipped with an ad hoc designed imaging module, which allows an automatic planar scan (see Fig. 4). This module constrains to perform measurements in normal reflection mode. In particular, the object under test is positioned on a movable

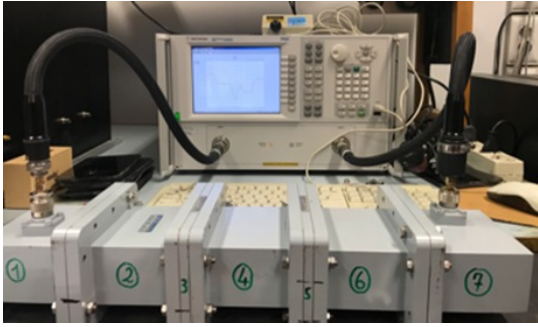

Fig. 3: Experimental set-up of the wave-guide technique.

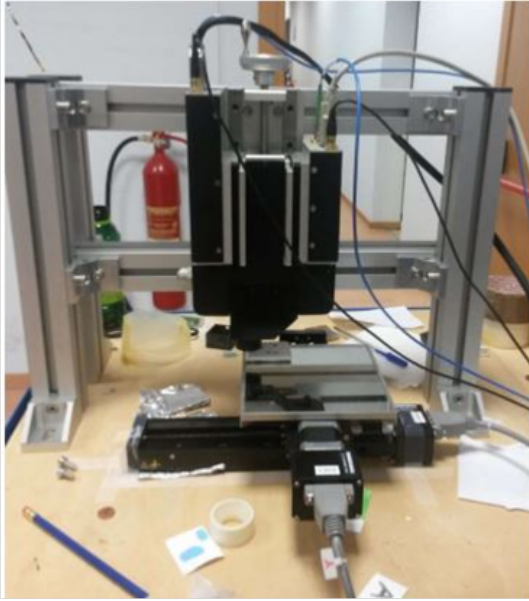

Fig. 4: Zomega FiCO system: imaging module.

platform and it is located at the focal distance by manually changing the height of the THz normal reflection module. The system collects signals into an about 100 ps observation time window, which can be moved along a time scan range of 1 ns according to the path length between the transmitter and the receiver. The waveform acquisition speed can be up to 500 Hz, and the maximum dynamic range (DNR) is 30 dB, while the typical DNR is 20 dB. The effective frequency range, when working in normal reflection mode and in normal environmental conditions, is from about 40 GHz up to 1.16 THz, as best it can. The FiCO system is enabled to scan a  $150\text{mm} \times 150\text{mm}$  area with physical resolution, i.e., smallest step size, of  $120\ \mu\text{m}$  along both  $x$  and  $y$  axes. It is worth noting that, due to occurrence of a secondary pulse arising from the Etalon effect, the obtained observation time window is reduced to about 50 ps. As a consequence, the maximum depth that can be investigated is  $d_{max} \leq 50 \cdot 10^{-12} \cdot v/2$ . This means that in the most favorable cases ( $c \sim v$ )  $d_{max}$  is about 7 mm. The data can be visualized and processed after the measurement stage.

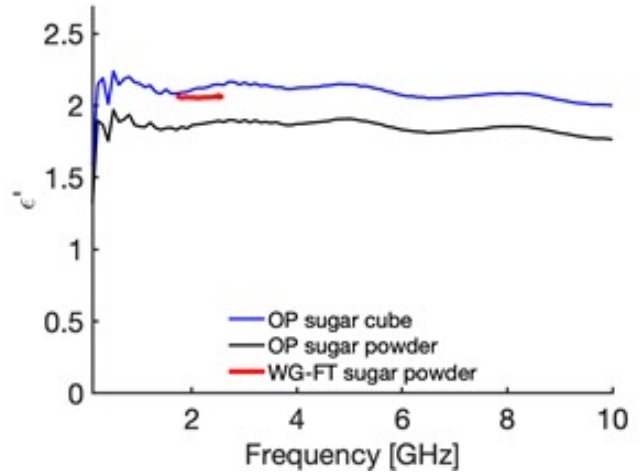

Fig. 5: Relative permittivity of sugar measured with the open probe technique (OP) and the waveguide with the Tran Fast (WG-TF) method.

### III. RESULTS

#### A. Measurement of dielectric properties at microwave frequencies

Figure 5 shows the relative permittivity of sugar in the microwave frequency range [500MHz - 10 GHz], as measured with the two techniques recalled above. In particular, in the figure, data measured with the open probe technique are reported considering a sample of a sugar cube and sugar powder, to put in evidence differences in the measured data related to different density of the MUT. In the same figure, the narrow-band measurements performed with the wave guide are also reported. From the comparison of the two data-sets, the influence of the density of the material on the measured values is evident. Such a characterization is useful to identify the kind of contaminants which can be possibly detected by means of EM technologies. For instance, the low value of the relative permittivity attained by the sugar on the overall analyzed frequency band, suggests that it is difficult to detect low-density materials, but a significant contrast would be present in case of “wet” contaminants, like for example insects, which is also a very likely case for sugar.

#### B. THz Imaging for packaging monitoring

An experiment referred to nondestructive testing of sugar bags with and without packaging defects was carried out with the FiCO system. A standard packaging (i.e., without defect) is shown in Fig. 6a, while the sachet of sugar in Fig. 6b shows a packaging with a thin surface defect having length of about 10 mm. The samples have an area of  $65\text{mm} \times 50\text{mm}$  and the data are gathered with a 0.4 mm spatial resolution along the  $x$  and  $y$  axes. Figures 7a and 7b show the false color THz images obtained by plotting, point by point, the maximum amplitude of the collected data. These figures indicate the ability of THz imaging to represent accurately the surface packaging defect, see Fig. 7b. It is worth pointing out that the sugar distribution



Fig. 6: Sugar bags (a) Standard packaging; (b) Defect packaging highlighted in the yellow box.

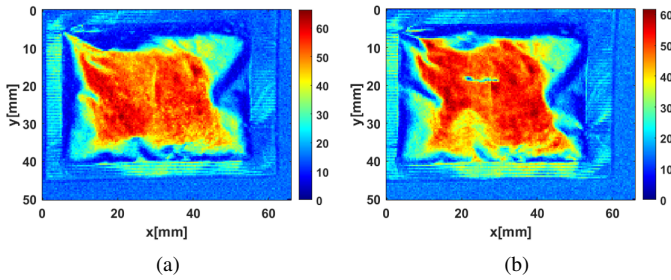

Fig. 7: False color THz image (a) Standard packaging; (b) Defect packaging.

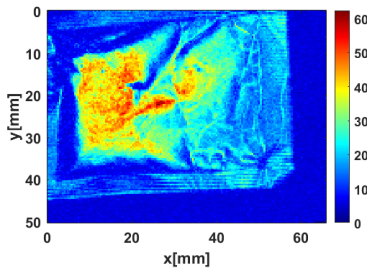

Fig. 8: False color THz image: The sugar has been moved on the left side.

inside the package is also visualized. This indicates that, despite the limits related to the penetration depth of the THz, it is possible, in principle, to investigate the content of the packet. To confirm this observation, Fig. 8 shows the THz image of a bag where the sugar has been moved to the left side. The sugar distribution is clearly distinguishable from the obtained image.

#### IV. CONCLUSION

In this communication, the broadband electromagnetic sensing of food products for quality control has been proposed and firstly investigated. The key idea is to take advantage of different portions on the EM spectrum, in order to keep advantages on both microwave and terahertz radiations. In particular, while microwaves allow the non invasive inspection of packaged products, to check possible contamination by

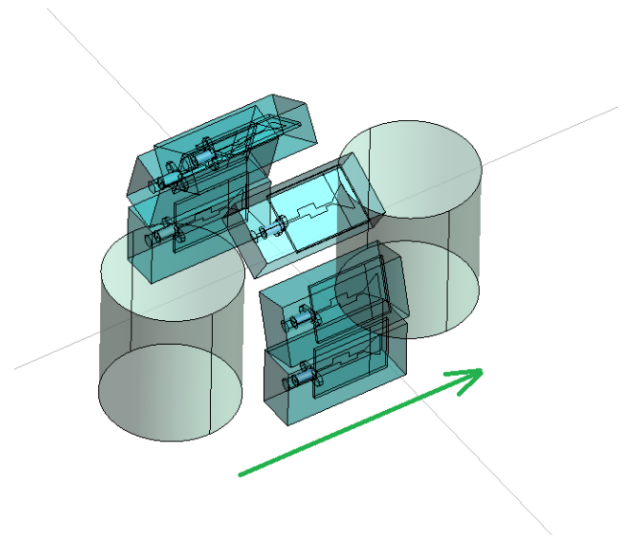

Fig. 9: Conceptual scheme of the MW device designed to work along a production chain. The antenna array is positioned to form an arch on the line, orthogonal to the movement direction.

foreign objects, terahertz waves, due to their high resolution capability but low penetration, are particularly suitable to monitor the integrity of the packaging or to detect possible superficial defects.

The preliminary study herein presented focuses on the case study of sugar. It deals first with sugar characterization in the MW frequency band and then it shows some preliminary experimental tests for the evaluation of the terahertz potential in detecting packaging defects.

Future work will deal with the development and experimental testing of a microwave system to monitor food products on a (scaled version) of a production line, in order to possibly detect the presence of contaminants in packaged items. The conceptual scheme of the hardware to be developed is depicted in Fig. 9 and it will be designed and realized according to the findings in [4].

#### ACKNOWLEDGMENT

This work has been supported by PRIN BEST-Food - Broadband Electromagnetic Sensing Technologies for Food quality and security assessment (grant n. 20179FLH4A).

#### REFERENCES

- [1] H. Einarsdóttir, M. J. Emerson, L. H. Clemmensen, K. Scherer, K. Willer, M. Bech, R. Larsen, B. K. Ersbøll, and F. Pfeiffer, "Novelty detection of foreign objects in food using multi-modal x-ray imaging," *Food Control*, vol. 67, pp. 39–47, 2016.
- [2] C.-C. Yang, M. S. Kim, S. Kang, B.-K. Cho, K. Chao, A. M. Lefcourt, and D. E. Chan, "Red to far-red multispectral fluorescence image fusion for detection of fecal contamination on apples," *Journal of Food Engineering*, vol. 108, no. 2, pp. 312–319, 2012.
- [3] Z. Wu and H. Wang, "Microwave tomography for industrial process imaging: Example applications and experimental results," *IEEE Antennas and Propagation Magazine*, vol. 59, no. 5, pp. 61–71, 2017.

- [4] J. A. Tobon Vasquez, R. Scapaticci, G. Turvani, M. Ricci, L. Farina, A. Litman, M. R. Casu, L. Crocco, and F. Vipiana, "Noninvasive inline food inspection via microwave imaging technology: An application example in the food industry," *IEEE Antennas and Propagation Magazine*, vol. 62, no. 5, pp. 18–32, 2020.
- [5] O. Schimmer, F. Daschner, and R. Knochel, "Uwb-sensors in food quality management—the way from the concept to market," in *2008 IEEE International Conference on Ultra-Wideband*, vol. 2. IEEE, 2008, pp. 141–144.
- [6] K. Dahlke, C. Geyer, S. Dees, M. Helbig, J. Sachs, F. S. di Clemente, M. Hein, W. A. Kaiser, and I. Hilger, "Effects of cell structure of gram-positive and gram-negative bacteria based on their dielectric properties," in *2012 The 7th German Microwave Conference*. IEEE, 2012, pp. 1–4.
- [7] M. Edwards, *Detecting foreign bodies in food*. Elsevier, 2004.
- [8] Y. Lee, S. Choi, S. Han, D. Woo, and H. S. Chun, "Detection of foreign bodies in foods using continuous wave terahertz imaging," *Journal of food protection*, vol. 75, no. 1, pp. 179–183, 2012.
- [9] K. Wang, D. Sun, and H. Pu, "Emerging non-destructive terahertz spectroscopic imaging technique: Principle and applications in the agri-food industry," *Trends in Food Science & Technology*, vol. 67, pp. 93–105, 2017.
- [10] [Online]. Available: <http://terasense.com/applications/terahertz-food-inspection/>
- [11] M. A. Stuchly and S. S. Stuchly, "Coaxial line reflection methods for measuring dielectric properties of biological substances at radio and microwave frequencies—a review," *IEEE Transactions on instrumentation and measurement*, vol. 29, no. 3, pp. 176–183, 1980.
- [12] A. Kraszewski, M. A. Stuchly, and S. S. Stuchly, "A calibration method for measurements of dielectric properties," *IEEE Transactions on Instrumentation and Measurement*, vol. 32, no. 2, pp. 385–387, 1983.
- [13] Keysight n1501a dielectric probe kit 10 mhz to 50 ghz, technical overview. [Online]. Available: <https://www.keysight.com/it/en/assets/7018-04631/technical-overviews/5992-0264.pdf> (last accessed on 13 October 2020).
- [14] G. Ruvio, M. Vaselli, V. Lopresto, R. Pinto, L. Farina, and M. Cavigliaro, "Comparison of different methods for dielectric properties measurements in liquid sample media," *Int. Journal of RF and Microwave Computer-Aided Engineering*, vol. 28, no. 3, p. e21215, 2018.
- [15] E. Piuze, C. Merla, G. Cannazza, A. Zambotti, F. Apollonio, A. Cataldo, P. D'Atanasio, E. De Benedetto, and M. Liberti, "A comparative analysis between customized and commercial systems for complex permittivity measurements on liquid samples at microwave frequencies," *IEEE Transactions on Instrumentation and Measurement*, vol. 62, no. 5, pp. 1034–1046, 2013.
- [16] *Materials measurement software : Technical overview*. Agilent Technol, Santa Clara, CA,USA.