

Impact of non-idealities on GNSS meta-signals processing

*Original*

Impact of non-idealities on GNSS meta-signals processing / Nardin, Andrea; Dosis, Fabio; Motella, Beatrice. - ELETTRONICO. - (2020), pp. 1-8. (Intervento presentato al convegno 2020 European Navigation Conference (ENC) tenutosi a Dresden, (Germany) nel 23-24 Nov. 2020) [10.23919/ENC48637.2020.9317365].

*Availability:*

This version is available at: 11583/2869798 since: 2021-02-08T12:31:36Z

*Publisher:*

IEEE

*Published*

DOI:10.23919/ENC48637.2020.9317365

*Terms of use:*

This article is made available under terms and conditions as specified in the corresponding bibliographic description in the repository

*Publisher copyright*

IEEE postprint/Author's Accepted Manuscript

©2020 IEEE. Personal use of this material is permitted. Permission from IEEE must be obtained for all other uses, in any current or future media, including reprinting/republishing this material for advertising or promotional purposes, creating new collecting works, for resale or lists, or reuse of any copyrighted component of this work in other works.

(Article begins on next page)

# Impact of non-idealities on GNSS meta-signals processing

Andrea Nardin \*, Fabio Dovis \*, Beatrice Motella \*\*

\*Politecnico di Torino  
Torino, ITALY  
email: [name.surname@polito.it](mailto:name.surname@polito.it)

\*\*LINKS Foundation  
Torino, ITALY  
email: [name.surname@linksfoundation.com](mailto:name.surname@linksfoundation.com)

***Abstract:** This paper deals with the concept of GNSS meta-signal processing, defined as the coherent process of two GNSS signals, broadcast on different carriers, and treated as a single wideband signal. The purpose of the paper is twofold: to analyse the effects on non-idealities on the meta-signal components and to investigate alternative schemes for the actual implementation inside the receiver.*

## 1. Meta-signals concept: motivation of the work

The fundamental concept of GNSS meta-signals processing, firstly introduced in [1] and further elaborated in [2], is to coherently process different signals broadcast on different carrier frequencies as a single wideband signal. Thanks to its correlation properties, the meta-signal might present advantages respect to the processing of each of the constituent signals, mainly in terms of multipath rejection and code and phase tracking noise [2].

As demonstrated in the literature [2]-[4], the ranging performance can be evaluated with the variance of the code thermal noise, bounded by the so-called Cramér-Rao Lower Bound (CRLB), which squared value is defined as

$$\sigma_{\text{CRLB}}^2 = \frac{B_n}{\frac{C}{N_0} (2\pi)^2 \int_{-\infty}^{\infty} f^2 G_s(f) df} \quad (1)$$

where  $B_n$  is the code tracking loop bandwidth,  $C/N_0$  is the carrier to noise density ratio of the received signal, and  $G_s(f)$  is the normalized power spectral density of the signal. The term  $\int_{-\infty}^{\infty} f^2 G_s(f) df$  corresponds to the second moment of the power spectrum. Its root value is also known as the Gabor Bandwidth (GB) or Root Mean Square (RMS) that can be evaluated as

$$\beta_{\text{rms}} = \sqrt{\int_{-B_{\text{fe}}/2}^{B_{\text{fe}}/2} f^2 G_s(f) df} \quad (2)$$

where  $B_{\text{fe}}$  is the two sided front-end bandwidth.

The synchronization accuracy that can be achieved with a GNSS signal in terms of CRLB increases with the second moment of the power spectrum of that signal. This means that a higher available signal bandwidth enables better synchronization accuracy.

On the other hand, the improved accuracy has to be paid with an increased complexity at the receiver side. In this regard, the scope of this paper is twofold: to analyse the effects on non-idealities on the meta-signal components and to investigate alternative schemes for the actual

implementation inside the receiver. The two aspects are presented hereafter, while last section summarizes some conclusions and remarks.

## 2. Impact of non-idealities

This section analyses the impact of non-idealities, intended as due to both channel and receiver, and expressed as a function of the frequency separation of the two signal components of a meta-signal ( $f_{\text{meta}}$ ). The methodology adopted for the analysis is described in the subsection hereafter, while the following two subsections present the parameters used in simulation, and the obtained results, respectively.

### Methodology

The analysis is based on the results of a simulation campaign, devoted to assess the impact of non-idealities on the Auto Correlation Function (ACF) of a meta-signal. The methodology used for the analysis can be described by the following steps:

- Definition of the metrics, based on the ACF analysis, for the signal performance assessment, i.e.,  $C/N_0$  degradation and ACF main peak/secondary peaks separation;
- Definition of the non-idealities impact, in terms of group delay, phase rotation, etc.;
- Evaluation of the meta-signal ACF in nominal conditions and in the presence of non-idealities;
- Performance degradation assessment through simulation campaigns;
- Critical comparison among different signal combinations and modulation options.

The scheme used for the simulation campaigns is sketched in Figure 1.

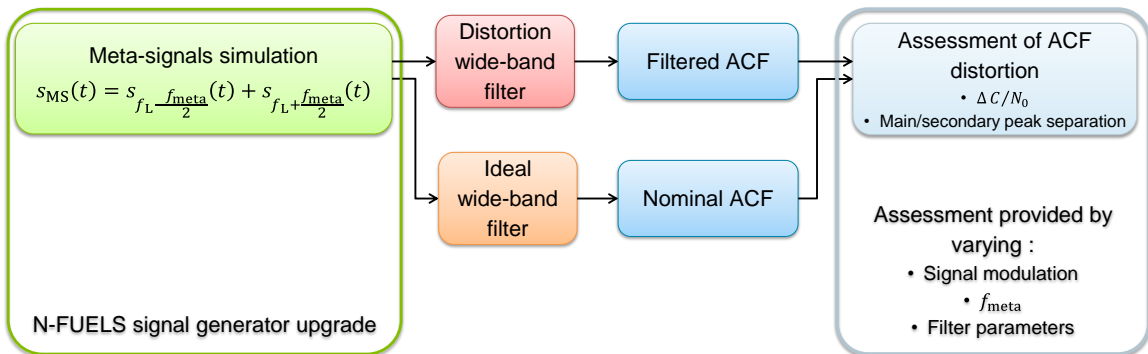

Figure 1. Methodology adopted for the assessment of the effect of non-idealities on meta-signals processing.

The meta-signals have been generated with N-FUELS (FULL Educational Library of Signals for Navigation), a MATLAB<sup>®</sup>-based GNSS signal generator, that allows the non-real time simulation of the physical layer signals of the GPS, Galileo and EGNOS systems [5] [6]. The modular nature of the tool allows the possibility to integrate new functionalities, for applications related to specific scenarios. In detail, it has been upgraded to include the generation of meta-signals. A wide-band filter is then properly designed and applied to the signal, in order to simulate non-idealities, introduced as a function of  $f_{\text{meta}}$ . The signal distortion can be finally assessed by comparing the ACF of the filtered signal with the nominal one, by evaluating two specific metrics:

- $\Delta C/N_0$ , i.e.: the expected degradation on the  $C/N_0$  value, estimated from the reduction of the ACF main peak;
- $PP_{\Delta}$ , i.e.: the ratio between the ACF main and secondary peaks, considered a key parameter for meta-signal tracking, due to potential false locks on secondary peaks.

## Signal and simulation parameters

Following the scheme of Figure 1, several simulations have been performed. This section briefly summarizes the parameters chosen for both the meta-signal and the distortion filter.

As for the signal, a meta-signal has been generated with N-FUELS, as constituted by two modulated signals, separated in frequency by  $f_{\text{meta}}$ , i.e.: a BOC(1,1)-signal summed up with an Offset BPSK(1), indicated as OBPSK( $f_{\text{meta}}$ ,1), or alternatively with an Offset BOC(1,1), indicated as OBOC( $f_{\text{meta}}$ ,1,1).

As an example, with  $f_{\text{meta}} = 12$  MHz, Figure 2 shows the base-band power spectral density and the autocorrelation function of the BOC(1,1) + OBPSK(12,1) meta-signal, where the two constituted signals are shifted at  $-f_{\text{meta}}/2$  and  $+f_{\text{meta}}/2$ , respectively.

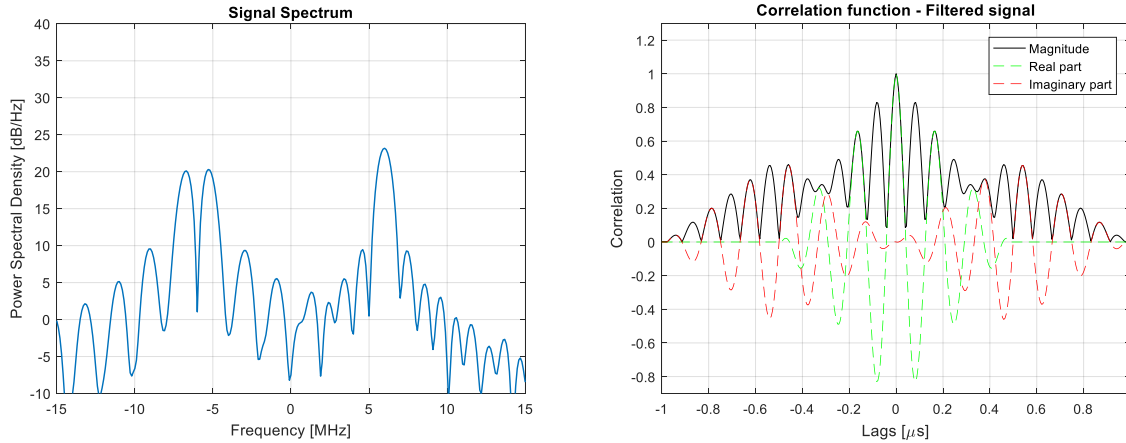

Figure 2. Power spectral density (left hand side) and autocorrelation function (right hand side) of the BOC(1,1) + OBPSK(12,1) meta-signal.

As said, non-idealities are modelled and introduced on the simulated signal through a wide-band filter, whose amplitude and group delay can be controlled by setting proper simulation parameters. Two filters have been designed with MATLAB<sup>®</sup>: one ideal, for comparison purposes, and one that actually introduces arbitrary distortions in terms of magnitude or group delay. In details:

- an ideal filter, with two-sided bandwidth of 60 MHz, with desired in band unitary magnitude and constant group delay;
- a filter that introduces distortions, designed by imposing specific values of desired magnitude response or group delay. The distortion filter parameters have been chosen on the basis of the values reported in [7]. In details, the approach for the filter design followed that described in [8]. For the analysis hereafter, the in-band filter magnitude response variation is set in the range  $[0 \div 20]$  dB, while the in-band filter group variation in the range  $[0 \div 150]$  ns.

## Results

By following the presented methodology, some results are discussed hereafter on the basis of the summarized signals parameters.

Considering the example of Figure 2, the meta-signal is composed as BOC(1,1) + OBPSK( $f_{\text{meta}}$ ,1). The results of the impact of non-idealities, due to the variation of in-band group delay, are shown in Figure 3, where we have: the degradation of the AFC main and secondary peaks, along with the absolute maximum value (a), the  $C/N_0$  loss (b), and the  $PP_{\Delta}$  (c) plotted as functions of the group delay variation.

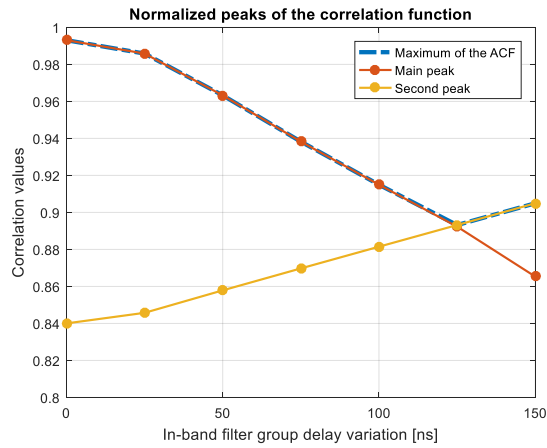

(a)

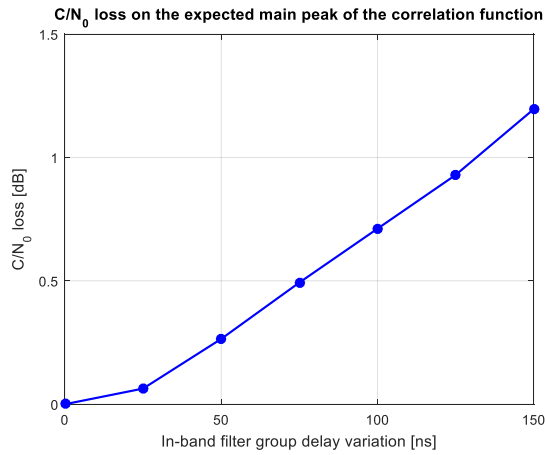

(b)

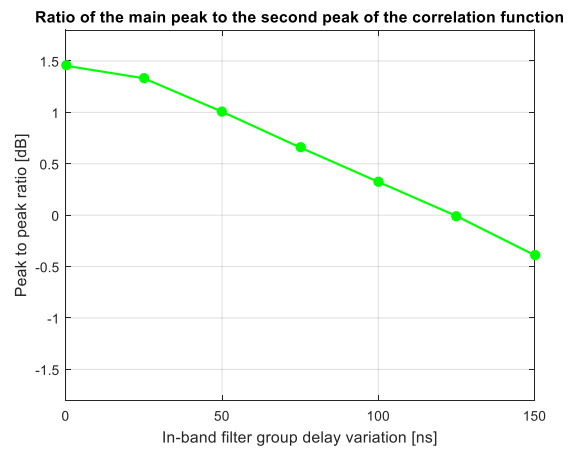

(c)

Figure 3. Effect of the in-band group delay variation on BOC(1,1) + OBPSK(12,1) meta-signal. ACF main and secondary peak degradation (a),  $C/N_0$  loss (b), and  $PP_\Delta$  (c), versus group delay variation.

The ACF main peak decreases, while the secondary one increases, leading to a negative value of  $PP_\Delta$ , for high variations of group delay (i.e.,  $PP_\Delta = -0.45$  dB for variation of group delay of 150 ns). The maximum degradation of  $C/N_0$  is 1.2 dB, for the considered interval of group delay variation.

As a further example, the comparison between a meta-signal with an offset BPSK or an offset BOC modulations is shown in Figure 4 and Figure 5, for variation of group delay and magnitude response respectively, for  $f_{\text{meta}} = 12$  MHz.

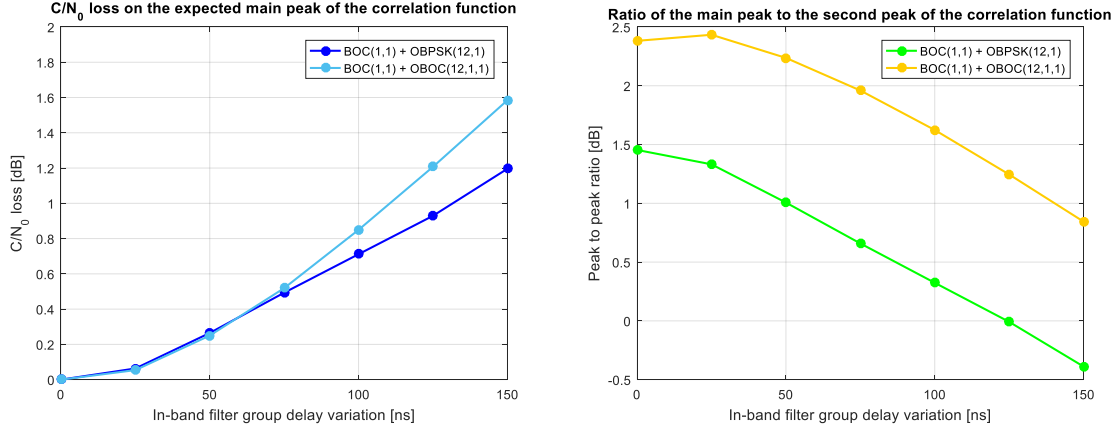

Figure 4. Effect of the in-band group delay variation: comparison between BOC(1,1) + OBPSK(12,1) and BOC(1,1) + OBOC(12,1,1) meta-signal.  $C/N_0$  loss (left hand side), and  $PP_{\Delta}$  (right hand side) versus group delay variation.

For variations of group delay (Figure 4), the case of OBPSK presents a lower degradation in terms of  $C/N_0$  loss, while the trend of  $PP_{\Delta}$ , is similar for the two meta-signals, though the combination BOC(1,1) + OBOC(12,1,1) is characterized by a higher peak to peak ratio, also in the absence of distortions: for 0 group delay variation,  $PP_{\Delta}$  is about 2.4 and 1.5 dB for the BOC(1,1) + OBOC(12,1,1) and BOC(1,1) + OBPSK(12,1), meta-signals combination respectively.

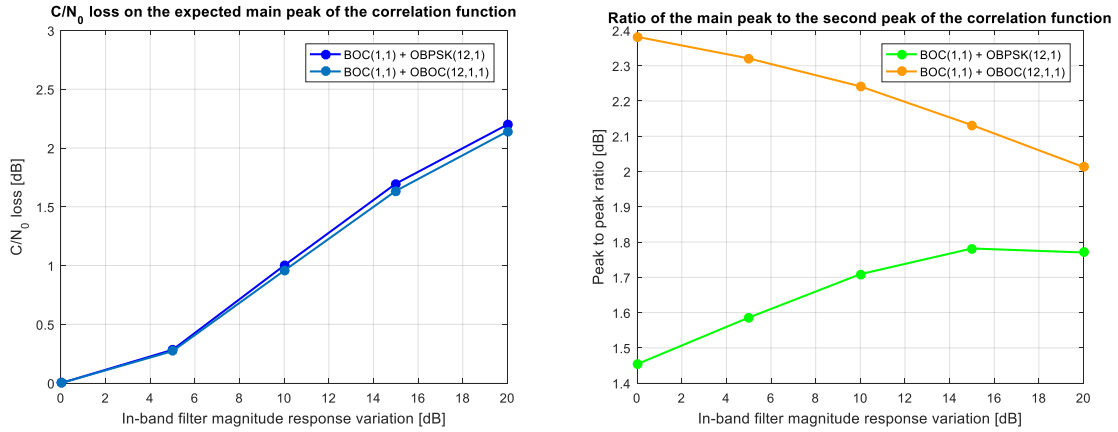

Figure 5. Effect of the in-band filter magnitude response variation: comparison between BOC(1,1) + OBPSK(12,1) and BOC(1,1) + OBOC(12,1,1) meta-signal.  $C/N_0$  loss (left hand side), and  $PP_{\Delta}$  (right hand side) filter magnitude variation.

For variations of magnitude response (Figure 5), the two signals have a very similar  $C/N_0$  trend, while the behaviour of the  $PP_{\Delta}$  is different: the metric in fact decreases for the BOC(1,1) + OBOC(12,1,1) signal, while, though always smaller, it increases for the BOC(1,1) + OBPSK(12,1) signal.

### 3. Meta-signals implementations: from Wideband to Virtual Wideband

The use of a wideband (WB) approach allows to exploit the combination of two signals by taking advantage of their larger Gabor bandwidth. However, the combined processing of synchronized channels enables the investigation of an additional approach, while still aiming at a reduced CRLB by means of a GB extension. This additional method is based on the independent baseband processing of two signals, which are up-converted to two opposite

frequencies within the Digital Signal Processing (DSP) chain and then combined at a correlator stage. Through this approach, we effectively build a Virtual WideBand (VWB) meta-signal that still benefits from an increased GB.

In a fixed-tone ranging technique, the highest tone controls the ultimate accuracy of the delay estimation, whereas the lower frequency tones solve the ambiguity introduced by the continuous-wave signals [10]. Similarly, in a ranging system based on PRN codes, a subcarrier frequency which is higher than the code-rate drives the accuracy, while the ranging code resolution (i.e. the chip duration) bounds the ambiguity of the correlator output, as experienced with BOC modulations [11]. Hence, if we are able to process a signal with a generally higher set of frequency components, we have a lower CRLB. This is true even when this frequency shift of the received signal is performed within the receiver processing architecture, as already shown in [12], where a dynamic variation of the Intermediate Frequency (IF) is employed for this purpose.

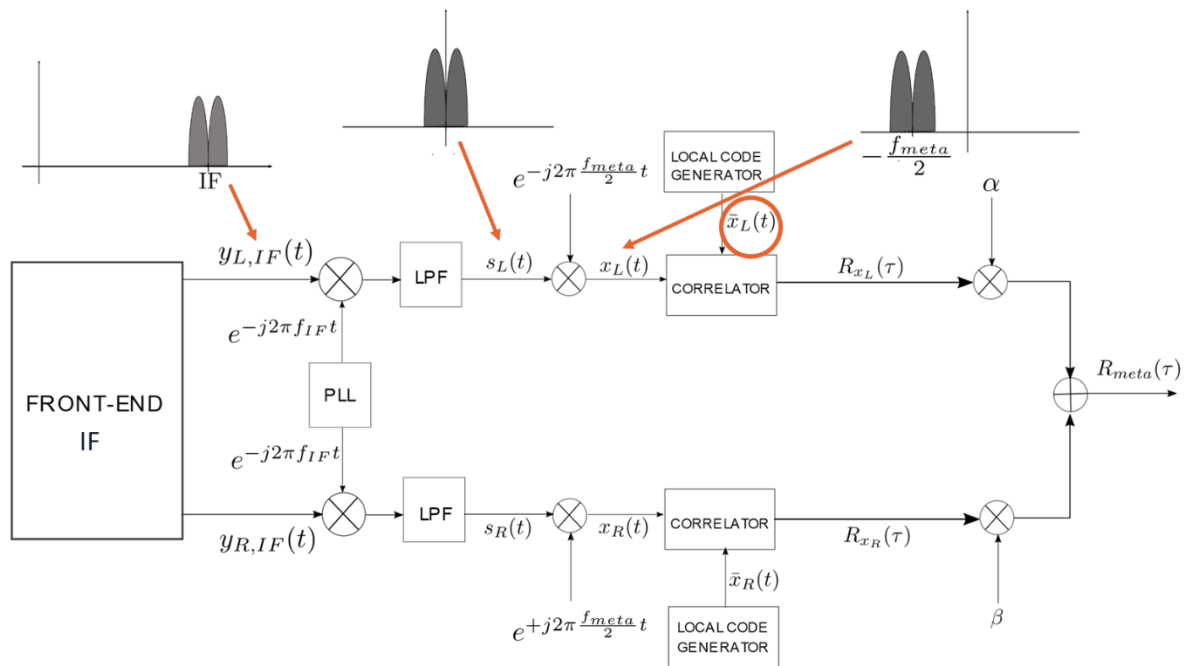

Figure 6. Open-loop scheme for virtual wide-band meta-signal processing.

A possible open-loop scheme for processing a VWB meta-signal is drawn in Figure 6. In this block diagram a front-end (FE) stage feeds the DSP chain with a down-converted version of two narrowband received radio-frequency signals centered on IF, namely  $y_{L,IF}(t)$  and  $y_{R,IF}(t)$ . A PLL-driven oscillator generates an IF carrier that moves both signals to baseband, obtaining  $s_L(t)$  and  $s_R(t)$ . These baseband signals are up-converted to a frequency  $-\frac{f_{meta}}{2}$  and  $+\frac{f_{meta}}{2}$  respectively, then correlated with a local replica of these signals. The local replicas are single ranging code signals up-converted as well to  $\pm \frac{f_{meta}}{2}$ . The resulting correlation functions  $R_{x_L}(\tau)$  and  $R_{x_R}(\tau)$  are then combined after a proper weighting, so that

$$R_{meta}(\tau) = \alpha R_{x_L}(\tau) + \beta R_{x_R}(\tau). \quad (3)$$

Thanks to two parallel correlator stages, this configuration has a further degree of freedom. By means of the weight coefficients  $\alpha$  and  $\beta$ , is possible to directly act on the final shape of the correlation function  $R_{meta}(\tau)$  and thus on the code delay estimation error.

An example of a tracking result inspired by this block diagram is provided in Figure 7. In this plot two BOC signals are combined to obtain a higher accuracy. The estimated code rate error is clearly reduced once the MSP is triggered.

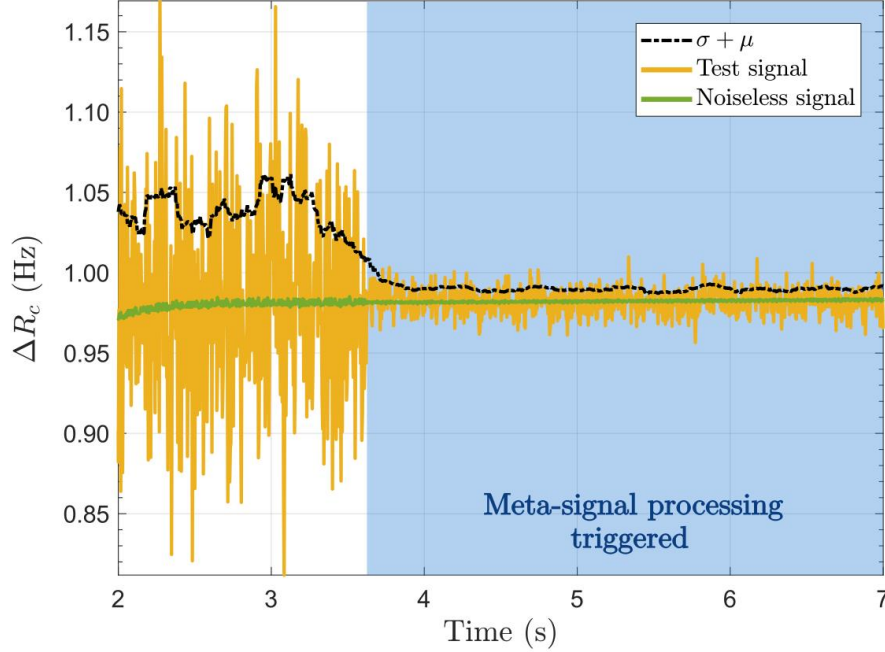

Figure 7. Estimated code rate error with a VWB approach.

While the WB and the VWB approaches are essentially equivalent in terms of correlation properties, they differ by the construction method of the meta-signal, which allows the VWB to be extremely more flexible. This flexibility is not only related to the weighting coefficients  $\alpha$  and  $\beta$ , but to the artificial construction of their frequency separation  $f_{meta}$ . In the VWB case in fact,  $f_{meta}$  can be arbitrarily set, as long as we can tolerate the ambiguity introduced by a higher carrier component. In a WB scheme instead, the Signal-In-Space (SIS) configuration sets the frequency separation. The processed meta-signal is a down-converted version of the SIS of the two components, that preserves their original frequency separation.

An effective implementation of the VWB paradigm requires affording the increased complexity of the scheme as well as the coherency issues that a separate processing can cause on the signals. The resulting flexibility however, is one of the main advantages of this approach and it may be worth the cost since, among the many possibilities opened, it enables almost any synchronized signal of a GNSS constellation as a potential candidate for meta-signal processing.

#### 4. Conclusions and remarks

The paper investigates two aspects of the meta-signal processing. It first discusses possible non-idealities due to both channel and receiver, presenting a simulation model able to assess their impact. In addition, it deals with the investigation of an alternative scheme for the actual implementation of meta-signal processing. This last approach demands a specific implementation involving the design of ad hoc PLL and DLL stages that have to deal with different synchronized signals. Although advantageous from a CRLB point of view, this



complex architecture might be sensitive to several signal impairments and its performance in harsh conditions will be investigated in future works.

## Acknowledgements

The work of Beatrice Motella has been performed within the FUNTIMES-2 (Future Navigation and TIMing Evolved Signals-2) project, funded by the European Commission under the Horizon 2020 Framework Program (Funding Reference No. 630/PPGRO/RCH/17/9877), and led by Airbus Defence and Space GmbH.

## References

- [1] J. Issler, M. Paonni and B. Eissfeller, "Toward centimetric positioning thanks to L- and S-Band GNSS and to meta-GNSS signals," *2010 5th ESA Workshop on Satellite Navigation Technologies and European Workshop on GNSS Signals and Signal Processing (NAVITEC)*, Noordwijk, 2010, pp. 1-8. doi: 10.1109/NAVITEC.2010.5708075.
- [2] Paonni, M., Curran, J.T., Bavaro, M., Fortuny-Guasch, J., "GNSS Meta-Signals: Coherently Composite Processing of Multiple GNSS Signals," *Proceedings of the 27th International Technical Meeting of the Satellite Division of The Institute of Navigation (ION GNSS+ 2014)*, Tampa, Florida, September 2014, pp. 2592-2601.
- [3] Elliott D. Kaplan, Christopher Hegarty, *Understanding GPS/GNSS: Principles and Applications*, Third Edition, Artech House, 2017, ISBN: 9781630810580.
- [4] Teunissen, Peter J.G., Montenbruck, Oliver, *Springer Handbook of Global Navigation Satellite Systems*, Springer, 2017, ISBN: 978-3-319-42928-1.
- [5] E. Falletti, B. Motella, G. Povero, and D. Margaria, "N-FUELS, a GNSS educational tool for simulation and analysis of a variety of signals in space," *Proceedings of the 2010 European Navigation Conference (2010 ENC GNSS)*, Braunschweig, Germany, 19-21 October 2010.
- [6] E. Falletti, D. Margaria, M. Nicola, G. Povero and M. T. Gamba, "N-FUELS and SOPRANO: Educational tools for simulation, analysis and processing of satellite navigation signals," 2013 IEEE Frontiers in Education Conference (FIE), Oklahoma City, OK, 2013, pp. 303-308. doi: 10.1109/FIE.2013.6684836.
- [7] Jean-Baptiste Pagot. *Modeling and monitoring of new GNSS signal distortions in the context of civil aviation*. Signal and Image processing. Ph.D. Thesis, Institut National Polytechnique de Toulouse (INP Toulouse), INPT, 2016.
- [8] D. Margaria, E. Falletti, A. Bagnasco, F. Parizzi and A. Torchi, "Impact of the group delay on BOC(M,N) tracking: Potential filter issues in robust side-lobe switching for high-order BOC modulations," 2013 International Conference on Localization and GNSS (ICL-GNSS), Turin, 2013, pp. 1-6. doi: 10.1109/ICL-GNSS.2013.6577269.
- [9] D. Margaria, B. Motella, and F. Dovis, "On the Impact of Channel Cross-Correlations in High-Sensitivity Receivers for Galileo E1 OS and GPS L1C Signals," *International Journal of Navigation and Observation*, vol. 2012, Article ID 132078, 10 pages, 2012. <https://doi.org/10.1155/2012/132078>.
- [10] Lindsey, William C., and Marvin Kenneth Simon. *Telecommunication systems engineering*. Courier Corporation, 1991.
- [11] Betz, John W., "The Offset Carrier Modulation for GPS Modernization," *Proceedings of the 1999 National Technical Meeting of The Institute of Navigation*, San Diego, CA, January 1999, pp. 639-648.
- [12] Yang Chun, Thomas Pany, and Andrey Soloviev. "An Implementation of Variable IF Tracking Loop (VITAL) and Initial Test Results." *Navigation: Journal of The Institute of Navigation* 64.4 (2017): 515-533.