

MAD: Multicriteria Anomaly Detection of Suspicious Financial Accounts from Billions of Cash Transactions

Original

MAD: Multicriteria Anomaly Detection of Suspicious Financial Accounts from Billions of Cash Transactions / Paoletti, Giordano; Giobergia, Flavio; Giordano, Danilo; Cagliero, Luca; Ronchiadin, Silvia; Moncalvo, Dario; Mellia, Marco; Baralis, Elena. - 2:(2025), pp. 4751-4760. (KDD '25: The 31st ACM SIGKDD Conference on Knowledge Discovery and Data Mining Toronto ON (CAN) August 3 - 7, 2025) [10.1145/3711896.3737244].

Availability:

This version is available at: 11583/3002315 since: 2025-08-04T11:43:34Z

Publisher:

Association for Computing Machinery (ACM)

Published

DOI:10.1145/3711896.3737244

Terms of use:

This article is made available under terms and conditions as specified in the corresponding bibliographic description in the repository

Publisher copyright

(Article begins on next page)

Defect prediction model for wrapping machines assembly

Verna, E.¹⁾, Genta, G.¹⁾, Galetto, M.¹⁾ and Franceschini, F.¹⁾

¹⁾ Politecnico di Torino, Department of Management and Production Engineering, Corso Duca degli Abruzzi 24, 10129 Torino, Italy

STRUCTURED ABSTRACT

Purpose – Development of a defect prediction model for the assembly of wrapping machines.

Design/methodology/approach – The assembly process of wrapping machines is firstly decomposed into several steps, called workstations, each one potentially critical in generating defects. According to previous studies, two assembly complexity factors related to the process and the design are evaluated. Experimental defect rates in each workstation are collected and a bivariate prediction model is developed.

Findings – Defects occurring in low-volume production, such as those of wrapping machines, may be predicted by exploiting the complexity based on the process and the design of the assembly.

Research limitations/implications – Although the defect prediction model is designed for the assembly of wrapping machines, the research approach can provide a framework for future investigation on other low-volume productions of similar electromechanical and mechanical products.

Practical implications – The defect prediction model is a powerful tool for quantitatively estimating defects of newly developed wrapping machines and supporting decisions for assembly quality-oriented design and optimisation.

Originality/value – The proposed model is one of the first attempts to predict defects in low-volume production, where the limited historical data available and the inadequacy of traditional statistical approaches make the quality control extremely challenging.

Keywords: Defect prediction, Assembly, Low-volume production, Wrapping machines.

Paper type: Research paper

INTRODUCTION

Defects occurring during the manufacturing process represent a huge issue for a wide range of industrial processes due to the dramatic impact they can cause, both in terms of quality and costs. The development and identification of appropriate models of defects predictions have long been a question of great interest in a wide range of manufacturing processes, including assembly. In the past years, a considerable literature has grown up around the theme of assembly defects, i.e. improper design, defective part, variance in assembly system and operator mistake. To this aim, traditional assembly quality control technologies and management approaches have been extensively exploited to evaluate, improve and control the assembly quality, such as design for assembly (DFA), Design of Experiments (DoE), Design Failure Modes and Effects Analysis (DFMEA), Statistical Process Control (SPC), data mining and sensor-based monitoring (Boothroyd and Alting, 1992; Shin et al., 2006; Zhang and Luk, 2007). Recently, some investigations have focused on assembly defects caused by operator errors, focusing on the close relationship between them and the product assembly complexity (Antani, 2014; Falck et al., 2017; Hinckley, 1994; Krugh et al., 2016; Shibata, 2002; Su et al., 2010). Although extensive research has been carried out on the prediction of operator-induced assembly defects, it has been mostly restricted to mass productions, involving millions of parts and assembly operations. To date, only a limited number of studies is directed to the investigation of defects occurring in low-volume assembly processes. Under these considerations, taking the wrapping machines assembly as an example, the mechanisms of the operator error-induced assembly defect are explored systematically in this paper. The specific objective of this study is to investigate the effect of assembly complexity on the defects occurring in low-volume assembly processes. Specifically, the Research Question (RQ) addressed in this paper is the following:

RQ: As for mass productions, can defects in the assembly processes of wrapping machines be predicted by assembly complexity?

In order to answer this question, the assembly process of wrapping machines is firstly decomposed into several steps, called workstations, and into elementary operations. Then, according to previous studies referring to mass productions, two assembly complexity factors related to the process and the design are obtained for each workstation. Experimental defect rates are collected, and the defect prediction model is developed. This study provides new insights into the prediction of defects in low-volume production, where the limited historical data available and the inadequacy of traditional statistical approaches make quality control extremely challenging. The defect prediction model developed is a powerful tool that designers can use to estimate defects of newly developed wrapping machines quantitatively and to design and optimise the assembly process of quality-oriented

wrapping machines. The findings of the present research should make an essential contribution to the field of low-volume assembly processes because, although the defect prediction model is specifically designed for the assembly of wrapping machines, the research approach can provide a general framework for future investigation on other low-volume productions, especially in electromechanical and mechanical fields.

The paper is arranged as follows. In "Assembly modelling of wrapping machines" section, the assembly process of wrapping machine, specifically that of the pre-stretching device, is modelled. Then, in "Assembly complexity factors" section, the two complexity factors related to the process and the design are introduced and analysed. The defects prediction model is discussed in "Defect prediction model" section. Finally, "Conclusions" section summarises the main findings of the paper, the limitation of the prediction model and the future research topics.

ASSEMBLY MODELLING OF WRAPPING MACHINES

Wrapping machines are electromechanical machines exploited at the end of production lines to pack palletised loads with a stretch plastic film. Three main categories of machines are typically available: (i) turn table, (ii) rotating arm and (iii) rotating ring wrapping machines (see Figure 1).

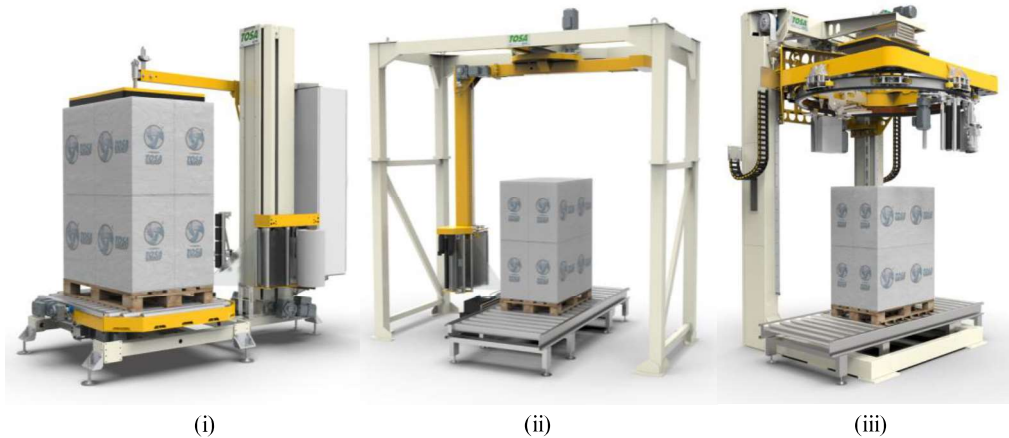

Figure 1 – Illustration of the three main categories of wrapping machines: (i) turn table, (ii) rotating arm and (iii) rotating ring.

This work focuses on the last category, i.e. the rotating wrapping machines produced in particular by the company Tosa Group S.p.A. (Italy). The total number of machines produced each year is of about 50 units. Accordingly, this production can be considered a low-volume manufacturing process. Furthermore, each assembled machine is highly customised, making it almost a unique piece.

Rotating wrapping machines consist of three main units: (i) mechanical unit, (ii) electrical and electronic unit and (iii) software unit. The mechanical unit (see Figure 2) is composed of two parts: one fixed and the other mobile. The fixed part is made up of:

1. the frame, i.e. the load-bearing structure, dimensioned to guarantee strength and durability, made up of boxes and profiles in high-strength sheet steel;
2. the cutting-hooking-welding unit that automatically cuts the plastic film employing a heated metal wire and heat-seals the last tail to the load with a special plate;
3. the pantograph presser, which stabilises the palletised load, exerting pressure on its top during the wrapping process.

Besides, the mobile part is made up of a trolley consisting of:

4. a rotating ring, built with a calendered steel profile, light but very resistant and therefore suitable for high speeds. It is moved by a special belt connected to an electric motor. The rotation of the ring around the palletised load is combined, during the winding cycle, with the vertical sliding of the rotating ring to which the pre-stretching unit is fixed;
5. the pre-stretching device, which is an electromechanical device, allowing: (i) the pulling/unwinding, (ii) the pre-stretch and positioning of the plastic film, (iii) the wrapping of the pallet with the required number of windings.

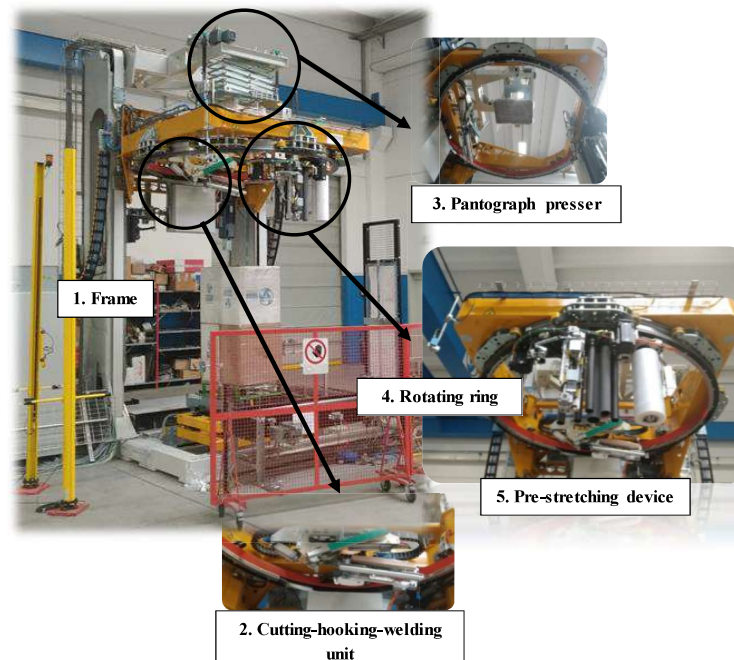

Figure 2 – Illustration of the main components of the mechanical group of a rotating ring wrapping machine of the company Tosa Group S.p.A. (Italy).

The electrical and electronic unit includes all the wiring of the various components, sensors and motors onboard the machine and the general electrical panel. The software unit is designed for the control of the machine, as well as for communication with the operator, whose programming and configuration is entrusted to a specialised external supplier.

During a typical working cycle, the palletised load is carried utilising a roller or belt conveyor system within the area delimited by the trolley. Then, the pantograph presser goes down by pressing on the top of the palletised load to ensure its stability during the film wrapping phase. The trolley goes down, the ring starts to rotate, and at the same time, the plastic film passes through the pre-stretching unit and is distributed around the load. After a variable number of wrappings according to the palletised load, the wrapping cycle ends: the cutting-hooking-welding unit provides to detach the plastic film tail, and the load is left free to be transported to the next station. Then a new pallet enters the perimeter of the machine ring and the cycle is repeated.

Given the complexity and the high number of components of the wrapping machine, this paper focuses on the assembly of the single pre-stretching device. The main reason is that, although each machine differs from the others in some details, this device is common to all rotating ring wrapping machines. Nevertheless, the proposed approach can be extended and implemented to the overall wrapping machine.

The pre-stretching device (see Figure 3) is installed on a support structure called frame plate. The stretch film runs through two rubber rollers, each one connected by a belt drive system to a brushless motor: the speeds of the two rollers are therefore independent of each other. By coming into contact with the surface of the two rollers, the film is stretched in quantity proportional to this speed difference, thus determining a significant increase in the length of the film that is wrapped on the load. The electronic system measures the speed using special sensors and keeps the tension of the film constant during its application on the entire surface of the pallet. Besides, the pre-stretching device may be equipped with a patent spindle which automatically replaces the empty film reel.

The assembly of the pre-stretch device may be subdivided into 29 workstations, as illustrated in Figure 4. According to previous studies, the workstations are assembly steps defined within operation standards, i.e. instruction sheets for work procedure (Shibata, 2002; Su et al., 2010). As evidenced in Figure 4, each of the pre-stretching device subassemblies is first assembled on the bench by an operator and then assembled on the frame plate. Each workstation can be decomposed in turn into job elements, defined as elementary operations that have definite start and end points (Shibata, 2002). These should have easily identifiable starting and stopping points and be repeatable regularly

throughout the working day (Aft, 2000). The number of job elements in each workstation is also reported in Figure 4.

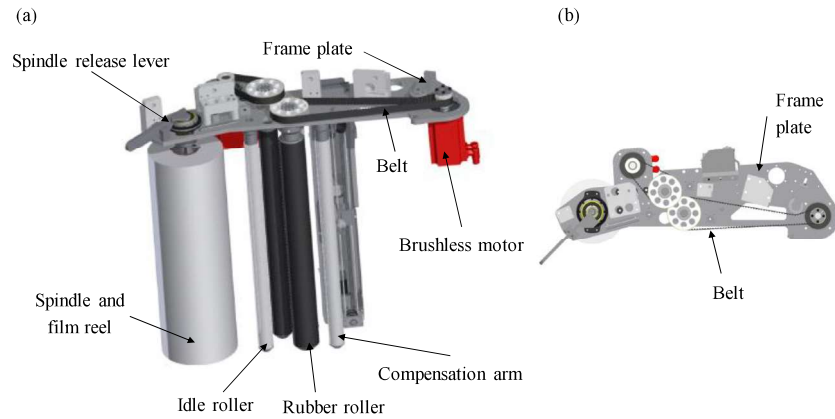

Figure 3 – 3D CAD model of the pre-stretching device: (a) front view and (b) top view, with indication of the main components.

BENCH ASSEMBLY			ASSEMBLY ON THE FRAME PLATE		
No. WS	WS Description	N_a	No. WS	WS Description	N_a
1	Motor no. 1 bench assembly	6	10	Pre-stretch frame plate preparation	3
2	Motor no. 2 bench assembly	6	11	Rubber rollers on pre-stretch frame plate assembly	4
3	Support plate of motor no. 2 bench assembly	3	12	Idle rollers on pre-stretch frame plate assembly	6
4	Spindle bench assembly	3	13	Motor no. 1 on frame plate assembly	1
5	Rubber tyres bench assembly	12	14	Transmission system of motor no. 1 assembly	2
6	Idle rolls bench assembly	12	15	Motor no. 2 on frame plate assembly	4
7	Rubberized pads bench assembly	3	16	Transmission system of motor no. 2 assembly	2
8	Belt tensioner device bench assembly	3	17	Motor no. 1 bracket on pre-stretch frame plate assembly	1
9	Driven wheels of transmission system bench assembly	2	18	Belt tensioner on pre-stretch frame plate assembly	2
			19	Transmission system of motor no. 1 calibration	2
			20	Transmission system of motor no. 2 calibration	2
			21	Spindle preparation for assembly on pre-stretch frame plate	2
			22	Spindle group on pre-stretch frame plate assembly	6
			23	Rubber pads on pre-stretch frame plate assembly	2
			24	Motor assembly no. 1 final steps	1
			25	Motor assembly no. 2 final steps	1
			26	Spindle release lever bench assembly	1
			27	Spindle release lever on pre-stretch frame plate assembly	3
			28	Compensation arm bench assembly	9
			29	Compensation arm on pre-stretch frame plate assembly	3

Figure 4 – Subdivision of the assembly process of the pre-stretching device into workstations (WS).

For each WS, the number of job elements (N_a) is evidenced (3rd column).

ASSEMBLY COMPLEXITY FACTORS

In this Section, the two predictors of the defect model used to estimate defects occurring in each workstation (process-based and design-based complexity factors) are described and analysed.

Process-based complexity factor

According to Shibata (2002), the Defects Per Unit occurring in each i -th workstation (DPU_i) may be predicted by exploiting the assembly times and the number of job elements in each i -th workstation, by defining a process-based complexity factor for each i -th workstation, called $Cf_{P,i}$, as follows:

$$Cf_{P,i} = \sum_{j=1}^{N_{a,i}} SST_{ij} - t_0 \cdot N_{a,i} = TAT_i - t_0 \cdot N_{a,i} \quad (1)$$

where $N_{a,i}$ is the number of job elements in the workstation i , SST_{ij} is the Sony Standard Time spent on the job element j in the workstation i , TAT_i is the total assembly time related to the workstation i , and t_0 is the threshold assembly time, i.e. the time required to perform the simplest assembly operation (Shibata, 2002).

In this work, instead of using Sony Standard Time (typical of Sony's home audio products), the times of each job element were evaluated by considering the average value of 3 measurements of the assembly times. The threshold assembly time t_0 was set at 0.04 min (specifically 2.33 s), which corresponds to the time required to perform the least complex job element. In Table 5, the obtained total assembly time TAT_i , and the final values of the first predictor $Cf_{P,i}$, for each i -th workstation, are listed.

Design-based complexity factor

As evidenced by Shibata (2002), the time-related measures, and therefore the $Cf_{P,i}$, may not capture all the sources of defects. For this reason, a design-based assembly complexity factor was introduced in his work (Shibata, 2002). Specifically, such design complexity factor was defined as the ratio between a calibration coefficient and the ease of assembly (EOA) coefficient of the corresponding workstation estimated through the assembly/disassembly cost-effectiveness (DAC) method developed in Sony Corporation (Yamagiwa, 1988). In a later study, Su et al. (2010) remarked that the DAC method was developed specifically for Sony electronic products; therefore it may not be directly suitable for other types of products, such as electromechanical products (copiers in particular). Accordingly, a different method for evaluating the design-based assembly complexity factor was proposed (Su et al., 2010). In this paper, since a wrapping machine is substantially an electrotechnical equipment, the design-based complexity factor of Su et al. (2010) was used as a second predictor.

The methodology adopted to evaluate the design-based complexity factor ($Cf_{P,i}$) is based on the approach developed by Ben-Arieh for evaluating the degree of difficulty of assembly operations (Ben-Arieh, 1994). According to Ben-Arieh (1994), assembly operations can be specified by parameters related to the parts' geometry (geometry-based parameters) and ones related to the type of contact between the components (non-geometrical parameters), see Table 1.

Table 1 - Parameters of assembly operations (Ben-Arieh, 1994).

Geometry-based parameters		Non-geometrical parameters	
(a)	Shape	(n)	Position contact
(b)	Force required	(o)	Snap contact
(c)	Mating direction	(p)	Spring contact
(d)	Alignment of components	(q)	Gear contact
(e)	Mating component's length	(r)	Clamp fit
(f)	Length of components intersection	(s)	Belt contact
(g)	Ratio of length to width (diameter) of the mating component		
(h)	Ratio of the mating component's weight to the mated one		
(i)	Stability of the resultant assembly		
(l)	Amount of support required for the assembly operation		
(m)	Interference (reachability) to the assembled component		

Depending on the characteristics of the products to be assembled, a number l of parameters should be selected as criteria for evaluating the design-based assembly complexity. In this work, $l=11$ parameters were selected (see Table 2), adapting Ben Arieh's approach to the case of wrapping machines. Then, to obtain an integrated index, the weights of the l criteria are allocated using the Analytic Hierarchy Process (AHP) approach (Ben-Arieh, 1994; Saaty, 1980; Wei et al., 2005). In detail, e evaluators, 2 engineers and 4 assembly operators in this specific study, are asked to compare the relative importance of each parameter in determining the difficulty of inserting a part into a product. The evaluation scale used for the relative importance between each pair of parameters ranges from a minimum of 1, which indicates equal importance of the two parameters, to a maximum of 9, which represents the dominant importance of the considered parameter with respect to the other. The result of this first interview produced a total of 6 paired comparison matrices, whose individual evaluations were then aggregated into a single paired comparison matrix representative of the group judgment by using the geometric mean, as suggested by Dong and Saaty (2014). From the paired comparison matrix reported in Table 3, the weights w_q of the l parameters were derived, according to Eq. (2), and are listed in Table 2:

$$w_q = (\prod_{r=1}^l a_{qr})^{1/l} / \sum_{q=1}^l (\prod_{r=1}^l a_{qr})^{1/l} \quad (q=1, \dots, l) \quad (2)$$

where:

- a_{qr} is the relative importance of parameter q over parameter r ($r=1, \dots, l$);
- l is the number of parameters (here $l=11$);
- w_q is the weight of parameter q , as listed in Table 2.

For instance, taking parameter P1 as an example, the corresponding weight w_q ($q=1$) is:

$$w_1 = \frac{1.761}{12.693} = 0.139$$

Table 2 - Parameters chosen from those in Table 1 for evaluating the design-based complexity factor and their weights.

Parameter	Ref. Table 1	Parameter description	Weight
P1	(a)	Shape of mating objects	0.139
P2	(b)	Force required	0.120
P3	(d)	Alignment of components	0.150
P4	(c)	Mating direction	0.169
P5	(h)	Ratio of the mating component's weight to the mated one	0.094
P6	(g)	Ratio of length to width (diameter) of the mating component	0.091
P7	(m)	Reachability to the assembled component	0.056
P8	(e)	Mating component's length	0.064
P9	(l)	Amount of support required for the assembly	0.037
P10	(i)	Stability of the resultant assembly	0.041
P11	(f)	Length of components intersection	0.038

Table 3 - Paired comparison matrix of parameters for evaluating the design-based assembly complexity.

Parameter	P1	P2	P3	P4	P5	P6	P7	P8	P9	P10	P11	$(\prod_{r=1}^l a_{qr})^{1/l}$
P1	1.00	1.32	1.96	0.78	0.60	2.59	5.58	2.72	2.93	1.53	2.38	1.761
P2	0.76	1.00	3.05	0.83	1.26	0.79	1.67	3.63	2.51	1.27	2.89	1.529
P3	0.51	0.33	1.00	1.26	3.04	1.26	3.80	2.12	5.10	4.93	7.41	1.907
P4	1.29	1.21	0.79	1.00	2.74	4.39	3.53	1.36	3.37	5.13	3.69	2.151
P5	1.66	0.79	0.33	0.53	1.00	1.47	1.02	1.10	3.45	5.44	0.97	1.192
P6	0.39	1.26	0.79	0.23	0.68	1.00	3.52	1.41	5.38	2.67	1.21	1.161
P7	0.18	0.60	0.26	0.28	0.98	0.28	1.00	1.28	1.76	1.31	3.69	0.714
P8	0.37	0.28	0.47	0.73	0.91	0.71	0.78	1.00	2.00	1.51	1.85	0.810
P9	0.34	0.40	0.20	0.30	0.29	0.19	0.57	0.50	1.00	1.51	1.24	0.466
P10	0.66	0.79	0.20	0.20	0.18	0.37	0.76	0.66	0.66	1.00	1.69	0.523
P11	0.42	0.35	0.13	0.27	1.03	0.82	0.27	0.54	0.81	0.59	1.00	0.480
$\sum_{q=1}^l (\prod_{r=1}^l a_{qr})^{1/l}$												12.693

Furthermore, the e evaluators were asked to express an evaluation on the degree of difficulty of each parameter in each workstation. Specifically, the evaluation of the parameter q -th in the workstation i -th estimated by the evaluator k -th is denoted as A_{kqi} . Such evaluations are rated by scores between 0 and 10. The question asked to the evaluators was the following: *"How much does the q -th parameter affect the assembly difficulty in the i -th workstation on a scale from 0 to 10, where 0 corresponds to no difficulty and 10 corresponds to maximum difficulty?"*

In order to align the assessment scales, the framework provided in Figure 5 was explained to each evaluator. This tool allowed the evaluators to use the same scale of judgement by creating conventional alignment metrics.

In this specific case, 6 matrices were obtained, one for each evaluator. Then, by averaging the evaluations of the e evaluators, for each q -th parameter in each i -th workstation, the matrix of the degrees of difficulty was derived (see Table 4).

Table 4 – Degrees of difficulty matrix for evaluating the design-based assembly complexity.

Workstation	Parameter										
	P1	P2	P3	P4	P5	P6	P7	P8	P9	P10	P11
1	4.00	4.17	4.17	4.50	5.17	3.67	4.33	3.17	6.00	5.83	5.50
2	4.33	4.33	4.17	4.50	5.17	3.67	5.67	3.33	6.00	5.83	6.33
3	5.83	6.50	5.50	4.33	4.00	3.50	5.00	4.00	6.50	5.00	6.00
4	3.67	4.00	3.50	3.33	4.83	3.83	6.00	5.17	6.00	6.83	6.67
5	4.17	7.33	4.83	5.33	4.67	6.33	5.83	6.67	7.83	6.50	7.33
6	3.83	5.67	4.83	3.50	4.00	5.83	5.00	6.50	6.33	6.50	6.67
7	2.83	3.50	3.00	2.67	1.50	2.00	2.67	1.67	3.00	4.00	4.83
8	3.83	4.17	4.17	3.17	2.33	1.83	3.50	1.83	4.67	5.00	5.50
9	5.00	2.83	6.00	2.83	2.33	2.67	2.83	2.33	1.17	6.17	5.17
10	4.17	3.50	5.00	2.00	6.17	5.33	2.67	4.33	5.67	5.83	4.83
11	4.00	4.67	6.17	3.67	6.33	7.17	4.50	7.67	5.33	6.83	5.67
12	4.00	4.00	6.00	3.67	6.00	6.83	4.50	7.17	5.00	7.17	5.33
13	3.83	5.17	6.67	4.83	5.83	4.83	3.50	5.00	5.50	5.33	5.00
14	6.17	5.00	6.67	6.33	3.17	4.00	6.00	3.83	3.17	6.67	6.17
15	4.17	5.00	6.50	4.50	5.17	5.00	4.17	4.83	5.17	5.00	3.67
16	5.50	4.83	5.83	6.00	2.67	3.67	6.00	3.00	2.83	6.17	6.17
17	3.17	3.67	6.33	5.00	4.00	3.33	3.33	3.17	3.17	4.83	4.00
18	3.67	3.67	6.50	5.17	3.00	3.33	4.00	2.83	3.00	6.33	2.67
19	4.33	5.17	7.33	5.67	3.50	5.00	5.83	3.00	3.83	6.83	4.67
20	4.33	5.17	7.33	5.67	3.50	4.50	5.50	3.83	3.83	6.67	5.67
21	3.50	4.17	6.17	4.83	6.33	7.00	4.50	7.17	4.33	4.50	4.67
22	5.50	5.67	5.33	5.17	5.67	6.50	6.33	6.83	5.17	4.50	4.67
23	3.50	4.67	4.67	4.00	3.50	3.17	4.33	3.67	3.67	5.83	6.17
24	3.17	3.17	5.17	5.33	3.83	3.00	4.67	2.67	3.17	5.00	4.83
25	3.33	3.33	5.67	5.50	3.83	3.17	4.50	3.17	3.00	5.00	4.83
26	4.00	2.83	5.50	5.00	2.50	3.33	3.67	4.00	2.83	5.00	4.83
27	4.33	4.67	5.83	5.00	4.17	3.50	4.50	4.83	3.33	6.00	5.17
28	4.83	4.33	6.33	5.17	5.17	6.17	5.17	7.33	5.33	6.83	6.33
29	3.83	4.50	5.83	5.83	3.33	5.00	4.67	6.00	3.00	5.83	6.83









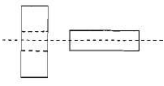
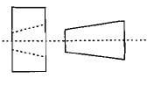
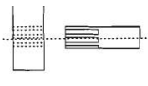
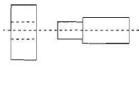
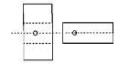

Parameter	Parameter description	Degree of difficulty 0-3	Degree of difficulty 3-6	Degree of difficulty 6-10
P1	Shape of mating objects			
P2	Force required	Simple coupling (no manual tool required)	Forced coupling (manual tool required)	Coupling with hydraulic press (20000 kg)
P3	Alignment of components	Mechanical stop 	Stop with reference 	No reference stop 
P4	Mating direction	Axial 	Eccentric axial 	Eccentric radial 
P5	Ratio of the mating component's weight to the mated one	Bearing lift (approx. 1 kg)	Idle roller lift (approx. 4 kg)	Frame plate lift (approx. 7 kg)
P6	Ratio of length to width (diameter) of the mating component	Belt tensioner device 	Frame plate 	Roller 
P7	Reachability to the assembled component	Simple coupling 	Medium complexity coupling 	Complex coupling 
P8	Mating component's length	Flanged sleeve 	Brushless motor 	Roller 
P9	Amount of support required for the assembly	No support 	Medium stable support 	Very stable support 
P10	Stability of the resultant assembly	Very stable resultant assembly	Medium stable resultant assembly	Poorly stable resulting assembly
P11	Length of components intersection	Low component coupling length	Medium component coupling length	High component coupling length

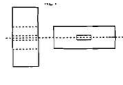
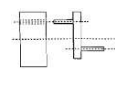
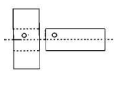
Figure 5 - List of parameters used to evaluate the design-based assembly complexity, with examples of the degrees of difficulty to be assigned during the assessment.

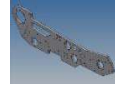
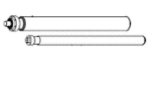
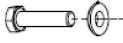
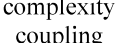
To clarify the evaluations listed in Table 4, a single workstation is analysed in detail: the workstation no. 22, i.e. the spindle group on pre-stretch frame plate assembly. In such workstation, 6 elementary operations are performed:

- 1) pre-tightening the spindle on a pre-stretch frame plate, repeated 12 times;
- 2) spindle clamping on pre-stretch frame plate, repeated 12 times;
- 3) tightening the screws on the intermediate spindle ring, repeated 3 times;
- 4) tightening the screws on the spindle brake support plate, repeated 4 times;
- 5) tightening the first spindle ring nut;
- 6) tightening the second spindle ring nut.

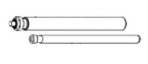
The elementary operations are carried out by the assembly operator using, in addition to his hands, simple equipment including a wrench and a torque wrench. The assembled spindle group on the pre-stretch frame plate is shown in Figure 6.

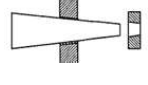

Figure 6 – Workstation no. 22: spindle group on pre-stretch frame plate assembly.

As can be seen in Table 4 for workstation 22, the degrees of difficulty range from a minimum of 4.50 to a maximum of 6.83. These values are within the intermediate difficulty range (fourth column of Figure 5) since the operations performed are mainly screw tightening activities on the spindle, requiring manual equipment and medium-complex couplings. Accordingly, they do not involve any particular assembly difficulties. The only exception is for parameter P8, whose degree of difficulty is almost 7, due to the high coupling length of the components to be assembled.

The design-based complexity factor, for each workstation, can be obtained by combining the weights of the parameters, see Table 2, and the degrees of difficulty matrix, see Table 4, as shown in Eq. (3):

$$Cf_{D,i} = \sum_{q=1}^l \left(w_q \cdot \frac{1}{e} \cdot \sum_{k=1}^e A_{kqi} \right) \quad (3)$$

Table 5 shows the values of the obtained design-based complexity factors in each i -th workstation.

DEFECT PREDICTION MODEL

The experimental DPU (Defects Per Unit) values that occurred under stationary process conditions in each i -th workstation of the pre-stretching device are listed in Table 5. Such values were obtained by combining the historical data of the company. Hence, they can be considered as the reference values of the average defectiveness rate of the assembly process of the pre-stretching device of wrapping machines in normal working conditions. As evidenced by Figure 7, where experimental DPU_i vs $Cf_{P,i}$ and $Cf_{D,i}$ are plotted, there is a clear power-law relationship between defects per unit and the two predictors. Previous investigations carried out on different assembled products belonging to different industrial context, including automobile, hard disk drive, semiconductor, audio equipment and copier companies, also demonstrated such power-law behaviour of DPU (Galetto, Verna and Genta, 2020; Hinckley, 1994; Hinckley and Barkan, 1995; Shibata, 2002; Shibata et al., 2003; Su et al., 2010). Accordingly, experimental data were analysed using a power-law regression model by *MATLAB*[®]:

$$DPU_i = a \cdot (Cf_{P,i})^b \cdot (Cf_{D,i})^c \quad (4)$$

It should be noted that, although Eq. (4) is linearisable, a recent study has shown that it is preferable using a nonlinear regression model in the case of few non-repeated data, affected by high variability, as highlighted by the well-known problem of the retransformation bias (Galetto, Verna and Genta, 2020). The defect prediction model obtained is the following (see also Figure 7):

$$DPU_i = 5.04 \cdot 10^{-5} \cdot (Cf_{P,i})^{0.77} \cdot (Cf_{D,i})^{3.08} \quad (5)$$

The DPU predicted using Eq. (5) are listed in Table 5. Finally, as shown in Figure 7 (b)-(e), the analysis of the residuals between experimental DPU and predicted DPU suggests that the power-law model describes well the trend of the DPU as a function of the assembly complexity. The Normal Probability Plot (NPP) indicates that the residuals are normally distributed, even though a slight hypernormality is evidenced, indicating a higher concentration of residuals around the central value. Furthermore, by performing the Anderson-Darling test, the null hypothesis that the residuals follow a normal distribution cannot be rejected with a p -value of 0.51 (Devore, 2011). The plot of residuals versus order shows a horizontal band around the residual line (value 0) and no systematic effects in the data due to time or data collection order are present. The S value, known both as the standard error of the regression and as the standard error of the estimate, is a measure of goodness of fit of the model to be used instead of R^2 for nonlinear models (Bates and Watts, 1988; Spiess and Neumeyer, 2010),

is 0.024. It indicates that the experimental values of DPU fall a standard distance (roughly an average absolute distance) of 0.024 units from the DPU values predicted by Eq. (5). It should be noted that S value is of the same order of magnitude of predicted DPU s. This can be attributed to the intrinsic variability of data and to the lack of replications (Galetto, Verna and Genta, 2020). As has already been investigated in a recent study, such defect prediction models could be exploited to identify the workstations whose defectiveness deviates, at a certain confidence level, from the predicted average value (Verna et al., 2020a). Consequently, appropriate corrective actions may be promptly undertaken to improve the process (Verna et al., 2020a). Besides, the defect prediction models can be adopted to obtain reliable predictions of defects probabilities. This information can be used in the design of appropriate quality-inspection strategies (Franceschini et al., 2018; Galetto, Genta, Maculotti, et al., 2020; Galetto, Verna, Genta, et al., 2020; Genta et al., 2018, 2020; Verna et al., 2020b, 2020c). Indeed, by combining these probabilities with different inspection parameters, the effectiveness and cost of alternative inspection strategies may be assessed and, accordingly, the most suitable quality-inspection may be selected by inspection designers.

Table 5 - Decomposition of the assembly of the pre-stretching device into 29 workstations (WS) with indication of the assembly complexity factors, $Cf_{P,i}$ and $Cf_{D,i}$ (see Eq. (1) and (3)), experimental DPU_i and predicted DPU_i (see Eq. (5)).

No. WS	TAT_i [min]	$Cf_{P,i}$ [min]	$Cf_{D,i}$	Experimental DPU_i	Predicted DPU_i
1	7.30	7.1	4.4	0.0364	0.0214
2	7.61	7.4	4.6	0.0364	0.0250
3	5.96	5.8	5.1	0.0182	0.0287
4	3.92	3.8	4.3	0.0000	0.0126
5	12.37	11.9	5.7	0.1091	0.0715
6	8.16	7.7	4.9	0.0545	0.0320
7	3.64	3.5	2.8	0.0000	0.0030
8	2.47	2.4	3.5	0.0364	0.0045
9	0.41	0.3	3.7	0.0000	0.0012
10	4.96	4.8	4.2	0.0182	0.0142
11	5.34	5.2	5.3	0.0182	0.0312
12	5.96	5.7	5.1	0.0182	0.0298
13	3.70	3.7	5.1	0.0000	0.0205
14	0.97	0.9	5.4	0.0000	0.0084
15	8.63	8.5	4.9	0.0182	0.0355
16	0.89	0.8	4.9	0.0364	0.0060
17	0.98	0.9	4.2	0.0000	0.0041
18	1.82	1.7	4.3	0.0364	0.0067
19	5.79	5.7	5.2	0.0364	0.0306
20	6.33	6.3	5.2	0.0364	0.0332
21	2.24	2.2	5.2	0.0000	0.0147
22	13.59	13.4	5.6	0.0364	0.0738
23	2.36	2.3	4.1	0.0000	0.0075
24	1.15	1.1	4.1	0.0545	0.0041

25	1.20	1.2	4.3	0.0545	0.0049
26	1.19	1.2	4.1	0.0000	0.0042
27	8.00	7.9	4.7	0.0000	0.0293
28	12.58	12.2	5.5	0.0909	0.0672
29	5.56	5.4	5.0	0.0000	0.0257

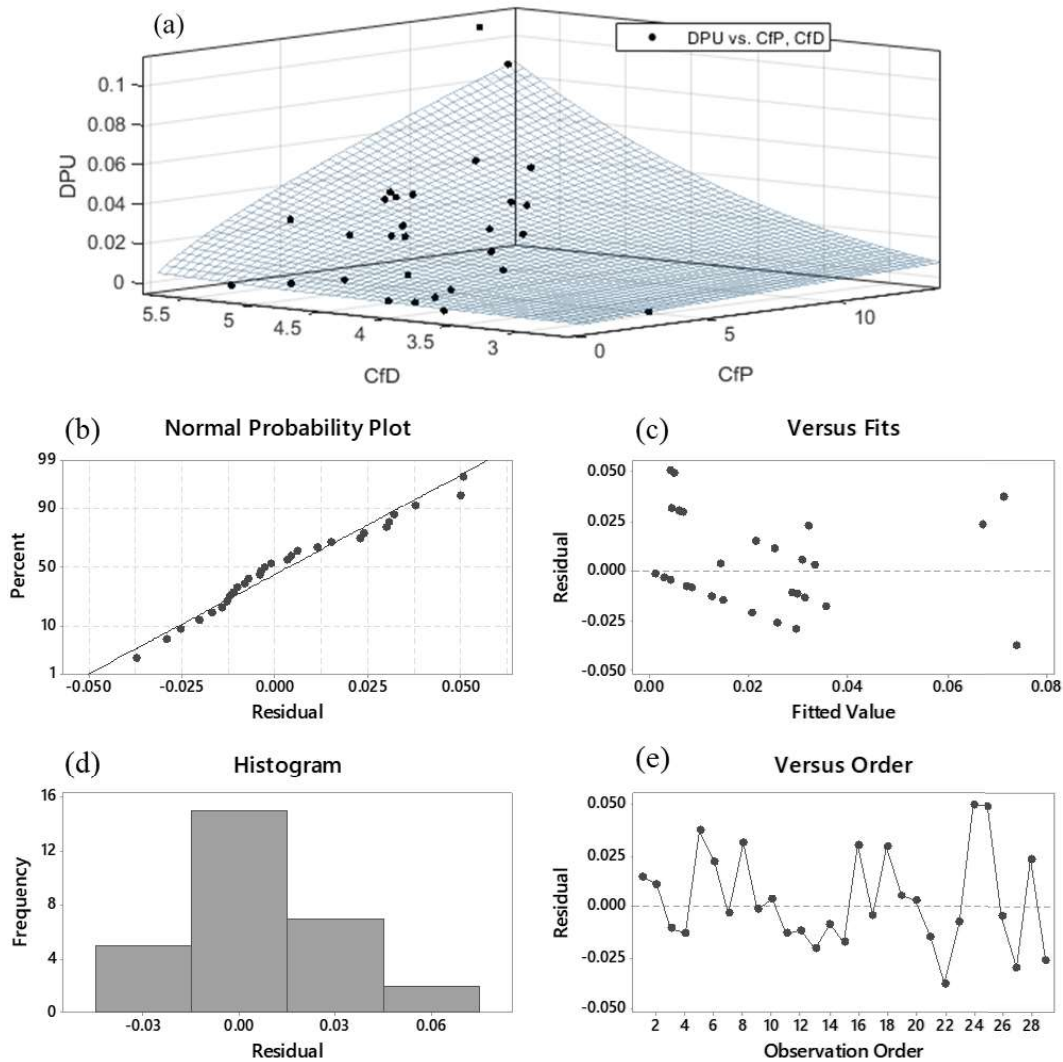

Figure 7 - (a) DPU vs Cf_P and Cf_D : defect prediction model, see Eq. (5), and experimental data; Plots of residuals between nominal DPU and predicted DPU : (b) Normal Probability Plot, (c) Residuals vs Fitted values, (d) Histogram and (e) Residuals vs Order.

CONCLUSIONS

The production of wrapping machines can be considered a low-volume assembly process because of the low production rate (about 50 machines assembled each year). Besides, each assembled machine is highly customised and therefore a unique exemplary. In this situation, applying traditional

statistical methods is extremely difficult due to the limited historical data available. The present research aimed to examine the assembly process of wrapping machines in order to develop a model for predicting defects occurring during the production process. The assembly process was firstly modelled by decomposing it into workstations (process steps) and job elements (elementary operations). Then, according to previous studies, two assembly complexity factors were defined: (i) the process-based complexity factor and (ii) the design-based complexity factor. The first one was obtained by exploiting the assembly times to perform the workstations and the number of elementary operations. The second one was derived by combining Ben-Arieh's method with the AHP method. These assembly complexity factors were considered the two predictors of the model adopted to estimate the Defects Per Unit (*DPU*) occurring in each workstation. In accordance with existing studies in the literature, the power-law model was selected as the most accurate fitting function in the *DPU* prediction. The obtained model, although specifically designed for wrapping machines assembly, can be used in other similar industrial contexts to predict defects in low-volume productions. Besides, the research approach can provide a framework for future explorations on other products, particularly for electromechanical and mechanical products. The proposed model can act both as a tool for quantitatively estimating defects of newly developed wrapping machines and as a decision support tool for the assembly quality-oriented wrapping machine design and optimisation. In particular, this defect prediction model can provide a useful tool to suggest engineers the appropriate strategy for assembly quality improvement. Generally, according to the values of the two complexity factors, a point on the prediction model corresponding to the current assembly quality level can be identified. At this point, based on cost and technical criteria, engineers can decide which of the two complexity factors should be reduced first, or whether to reduce them both simultaneously, to achieve the target quality level.

Further research need to examine alternative models involving different predictors for evaluating the overall product complexity. To this aim, authors have recently investigated the adoption of the complexity paradigm proposed by Alkan (2019) and Sinha (2014), which is based on product structural properties associated with handling and insertion of assembly parts, and their architectural structure (Verna et al., 2020d). Furthermore, authors are planning to expand the research approach by moving the perspective from product complexity to production process or production system complexity. This research progress entails combining the models of defect prediction with inspection variables to support the design of quality-inspection strategies in low-volume assembly processes.

ACKNOWLEDGEMENTS

The authors gratefully acknowledge the company Tosa Group S.p.A. (Italy) for the collaboration in this project. This work has been partially supported by the "Italian Ministry of Education, University and Research", Award "TESUN-83486178370409 finanziamento dipartimenti di eccellenza CAP. 1694 TIT. 232 ART. 6".

REFERENCES

- Aft, L.S. (2000), *Work Measurement and Methods Improvement*, John Wiley & Sons, Hoboken, NJ, USA.
- Alkan, B. (2019), "An experimental investigation on the relationship between perceived assembly complexity and product design complexity", *International Journal on Interactive Design and Manufacturing (IJIDeM)*, Vol. 13 No. 3, pp. 1145–1157.
- Antani, K.R. (2014), *A Study of the Effects of Manufacturing Complexity on Product Quality in Mixed-Model Automotive Assembly*, PhD dissertation, Mechanical Engineering Department, Clemson University.
- Bates, D.M. and Watts, D.G. (1988), *Nonlinear Regression Analysis and Its Applications.*, John Wiley & Sons, Inc., Hoboken, NJ, USA.
- Ben-Arieh, D. (1994), "A methodology for analysis of assembly operations' difficulty", *International Journal of Production Research*, Taylor & Francis, Vol. 32 No. 8, pp. 1879–1895.
- Boothroyd, G. and Alting, L. (1992), "Design for assembly and disassembly", *CIRP Annals*, Elsevier, Vol. 41 No. 2, pp. 625–636.
- Devore, J.L. (2011), *Probability and Statistics for Engineering and the Sciences*, Cengage learning, Boston, USA.
- Dong, Q. and Saaty, T.L. (2014), "An analytic hierarchy process model of group consensus", *Journal of Systems Science and Systems Engineering*, Vol. 23 No. 3, pp. 362–374.
- Falck, A.-C., Örtengren, R., Rosenqvist, M. and Söderberg, R. (2017), "Proactive assessment of basic complexity in manual assembly: development of a tool to predict and control operator-induced quality errors", *International Journal of Production Research*, Vol. 55 No. 15, pp. 4248–4260.

Franceschini, F., Galetto, M., Genta, G. and Maisano, D.A. (2018), "Selection of quality-inspection procedures for short-run productions", *The International Journal of Advanced Manufacturing Technology*, Vol. 99 No. 9–12, pp. 2537–2547.

Galetto, M., Genta, G., Maculotti, G. and Verna, E. (2020), "Defect Probability Estimation for Hardness-Optimised Parts by Selective Laser Melting", *International Journal of Precision Engineering and Manufacturing*, DOI: 10.1007/s12541-020-00381-1.

Galetto, M., Verna, E. and Genta, G. (2020), "Accurate estimation of prediction models for operator-induced defects in assembly manufacturing processes", *Quality Engineering*, DOI: 10.1080/08982112.2019.1700274.

Galetto, M., Verna, E., Genta, G. and Franceschini, F. (2020), "Uncertainty evaluation in the prediction of defects and costs for quality inspection planning in low-volume productions", *The International Journal of Advanced Manufacturing Technology*, Vol. 108 No. 11, pp. 3793–3805.

Genta, G., Galetto, M. and Franceschini, F. (2018), "Product complexity and design of inspection strategies for assembly manufacturing processes", *International Journal of Production Research*, Vol. 56 No. 11, pp. 4056–4066.

Genta, G., Galetto, M. and Franceschini, F. (2020), "Inspection procedures in manufacturing processes: recent studies and research perspectives", *International Journal of Production Research*, DOI: 10.1080/00207543.2020.1766713.

Hinckley, C.M. (1994), *A Global Conformance Quality Model. A New Strategic Tool for Minimising Defects Caused by Variation, Error, and Complexity*, PhD dissertation, Mechanical Engineering Department, Stanford University.

Hinckley, C.M. and Barkan, P. (1995), *A Conceptual Design Methodology for Enhanced Conformance Quality*, Sandia National Labs., Livermore, CA (United States).

Krugh, M., Antani, K., Mears, L. and Schulte, J. (2016), "Prediction of Defect Propensity for the Manual Assembly of Automotive Electrical Connectors", *Procedia Manufacturing*, Vol. 5, pp. 144–157.

Saaty, T.L. (1980), *The Analytic Hierarchy Process*, McGraw-Hill, New York.

Shibata, H. (2002), *Global Assembly Quality Methodology: A New Methodology for Evaluating Assembly Complexities in Globally Distributed Manufacturing*, PhD dissertation, Mechanical Engineering Department, Stanford University.

Shibata, H., Cheldelin, B. and Ishii, K. (2003), "Assembly quality methodology: A new method for evaluating assembly complexity in globally distributed manufacturing", in ASME 2003 International Mechanical Engineering Congress and Exposition in Washington, DC, USA, November 15–21, 2003, The American Society of Mechanical Engineers, pp. 335–344.

Shin, D., Wysk, R.A. and Rothrock, L. (2006), "An investigation of a human material handler on part flow in automated manufacturing systems", IEEE Transactions on Systems, Man and Cybernetics - Part A: Systems and Humans, Vol. 36 No. 1, pp. 123–135.

Sinha, K. (2014), Structural Complexity and Its Implications for Design of Cyber-Physical Systems, PhD dissertation, Engineering Systems Division, Massachusetts Institute of Technology.

Spiess, A.N. and Neumeyer, N. (2010), "An evaluation of R2 as an inadequate measure for nonlinear models in pharmacological and biochemical research: A Monte Carlo approach", BMC Pharmacology, Vol. 10, pp. 1–11.

Su, Q., Liu, L. and Whitney, D.E. (2010), "A systematic study of the prediction model for operator-induced assembly defects based on assembly complexity factors", IEEE Transactions on Systems, Man and Cybernetics - Part A: Systems and Humans, Vol. 40 No. 1, pp. 107–120.

Verna, E., Genta, G., Galetto, M. and Franceschini, F. (2020a), "Defect prediction models to improve assembly processes in low-volume productions", forthcoming in 8th CIRP Conference of Assembly Technology and Systems in Athens, Greece, 29 September-1 October, 2020, Procedia CIRP.

Verna, E., Genta, G., Galetto, M. and Franceschini, F. (2020b), "Planning offline inspection strategies in low-volume manufacturing processes", Quality Engineering, DOI: 10.1080/08982112.2020.1739309.

Verna, E., Genta, G., Galetto, M. and Franceschini, F. (2020c), "Inspection planning by defect prediction models and inspection strategy maps for low-volume productions", submitted to The International Journal of Advanced Manufacturing Technology.

Verna, E., Genta, G., Galetto, M. and Franceschini, F. (2020d), "Product assembly and defect prediction: a novel model based on the structural complexity paradigm", submitted to International Journal of Production Research.

Wei, C.C., Chien, C.F. and Wang, M.J.J. (2005), "An AHP-based approach to ERP system selection", International Journal of Production Economics, Vol. 96 No. 1, pp. 47–62.

Yamagiwa, Y. (1988), "An assembly ease evaluation method for product designers: DAC", Techno Japan, Vol. 21 No. 12, pp. 26–29.

Zhang, F. and Luk, T. (2007), "A Data Mining Algorithm for Monitoring PCB Assembly Quality", IEEE Transactions on Electronics Packaging Manufacturing, Vol. 30 No. 4, pp. 299–305.