

Handwheelchair.q New prototype of manual wheelchair for everyday life

Original

Handwheelchair.q New prototype of manual wheelchair for everyday life / Cavallone, Paride; Bonisoli, Elvio; Quaglia, Giuseppe (MECHANISMS AND MACHINE SCIENCE). - In: Advances in Italian Mechanism ScienceELETTRONICO. - Cham : Springer, 2020. - ISBN 978-3-030-55806-2. - pp. 111-119 [10.1007/978-3-030-55807-9_13]

Availability:

This version is available at: 11583/2846238.13 since: 2020-10-23T08:25:22Z

Publisher:

Springer

Published

DOI:10.1007/978-3-030-55807-9_13

Terms of use:

openAccess

This article is made available under terms and conditions as specified in the corresponding bibliographic description in the repository

Publisher copyright

Springer postprint/Author's Accepted Manuscript

This version of the article has been accepted for publication, after peer review (when applicable) and is subject to Springer Nature's AM terms of use, but is not the Version of Record and does not reflect post-acceptance improvements, or any corrections. The Version of Record is available online at: http://dx.doi.org/10.1007/978-3-030-55807-9_13

(Article begins on next page)

Handwheelchair.q: new prototype of manual wheelchair for everyday life

Paride Cavallone, Elvio Bonisoli and Giuseppe Quaglia

Politecnico di Torino, Italy
paride.cavallone@polito.it

Abstract. In this paper the second prototype of a manual wheelchair, named Handwheelchair.q, is presented. Handwheelchair.q is a manual wheelchair with an innovative system of propulsion inspired by a rowing gesture which has been made possible employing a cable for the motion transmission to a special free-wheel connected to the wheel. As a result this gesture generates a traction force on the shoulder instead of the compression force generated by the gesture with the hand-rim system. The main goal of the innovative prototype is to increase the mobility of the disabled people reducing the stress on shoulder employing a conventional manual wheelchair. The functional design and the prototype are presented. Moreover, the methods and the results of preliminary tests are described and discussed. The tests aim to evaluate the traction force and the efficiency of the prototype.

Keywords: Handwheelchair, Spinal cord injury, Disabled mobility, Innovative wheelchair, Rowing gesture.

1 Introduction

Statistics show that in the world the 1-2% of population requires a wheelchair [1]. Even if an important part of the global market, especially in the developed countries, concerns the powered wheelchair, manual wheelchairs remain an important means of mobility especially in developing countries and for disabled people with an active life. Currently, two categories of manual wheelchair can be identified based on their own specific functions. The manual wheelchair employed in everyday life [2,3] and for specific sports [4-6]. Different systems of propulsion for manual wheelchairs have been studied and prototyped for both uses. The most popular propulsion system employed for manual wheelchair for everyday life is the hand rim [7]. Other types are the lever system used in different configuration [8] and the handbike [9] for sport activities. Alternative systems of propulsion for manual wheelchair have been developed in order to solve the upper limb injuries caused by the hand rim system. In the past, the authors presented the concept and the functional design of an innovative propulsion system, named Handwheelchair.q, for manual wheelchair both for everyday life [10] and sport [11,12]. The first prototype of Handwheelchair.q has been shown in [13]. The

transmission system of the second prototype has been redesigned in order to reduce the transversal dimension of the wheelchair. In the second prototype, the support of the return pulleys has been replaced with a telescopic rod and the return pulleys have been optimised. In addition, the second prototype is equipped with a measurement system.

2 Functional design

The Handwheelchair.q consists in six subsystems, Fig. 1: the frame, the transmission systems, the return pulleys, the telescopic rod, the handles and the brake systems. In Figure 1 the functional design of the Handwheelchair.q is presented. The user of the Handwheelchair.q grasps two handles, left and right. Each handle is connected with a cable that is wrapped around a pulley. Two return pulleys are positioned in front of the user in order to perform a movement inspired a rowing gesture.

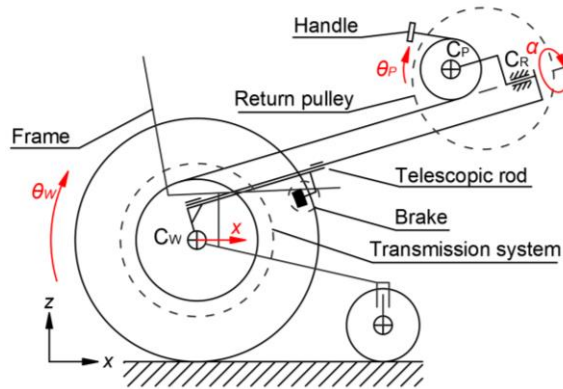

Fig. 1. Functional design of Handwheelchair.q

2.1 Transmission system

The transmission system consists in two pulleys, left and right. Each pulley is connected with the frame via a power spring. The pulleys rotate by the cable pulled by the user and via, the freewheel, they transmit the motion to the wheels Fig. 2 a). When the user pulls the cables, the power return springs are loaded. In this way, when the user stops of pulling, the power springs rotate in the opposite direction and the cables are rewound on the pulleys.

2.2 Return pulleys

The return pulleys are positioned in front of the user in order to achieve a movement inspired by a rowing gesture, namely a traction gesture. Each return pulley is connected with the frame through a component with two passive degrees of freedom (DOF). The first DOF θ_p enables the rotation of the pulleys when the user pulls the cable. The second DOF α enables the roll of the pulleys around the axle of the cable in the section

between the pulley and the return pulley, Fig. 2 b). Like this the roll of the return pulleys avoid the misalignment of the groove of the pulley and return pulley.

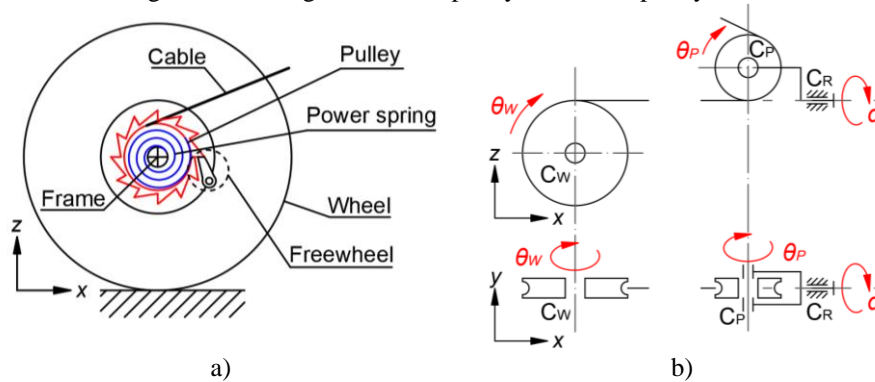

Fig. 2. Functional design of the a) transmission system and b) the return pulley

3 Prototype

Fig. 3 shows the second prototype of Handwheelchair.q. Fig. 3 a) shows the handwheelchair.q in the configuration in order to use the innovative system of propulsion while Fig. 3 b) shows the configuration with the retracted telescopic rod in order to use the wheelchair indoor (by means of hand rim) or to get on or get off easily.



Fig. 3. a) Innovative configuration and b) with retracted telescopic rod

4 Experimental Methods

The Handwheelchair.q has been equipped with a measurement system composed by two load cells devoted to hands traction forces detection and two Hall sensors addressed to wheels speed monitoring. Each load cell has been mounted between the handle and the cable as shown in Fig. 4 in order to measure the right and left user force. In the static condition the torque of each spring is about 0,7 Nm. Twenty-eight magnets have been positioned equidistantly on the wheels and a Hall sensors has been placed on the frame in order to detect the signal magnetic field.

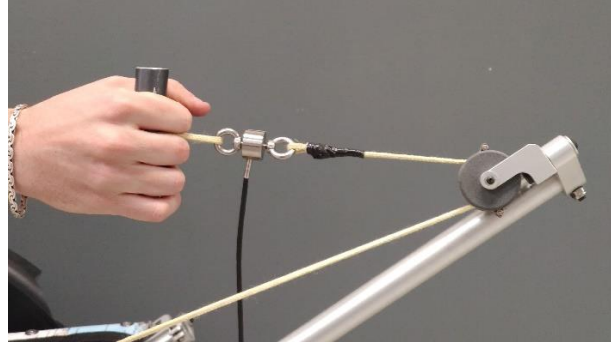

Fig. 4. Load cell

A data acquisition system composed of an acquisition card and a PC have been positioned on the Handwheelchair.q. The test has been performed starting from rest on a flat path and reaching an average speed. The test aims at evaluating the traction forces generated by a user during the acceleration phase and the steady-state condition. In Table 1 the relevant quantities are shown.

Table 1. Parameters.

Symbol	Description	Value	Unit
r_w	Wheel radius	0,292	m
r_p	Pulley radius	0,1	m

Table 2. Variables.

Symbol	Description	Unite of measure
$\omega_{w,L}; \omega_{w,R}$	Left and right wheel angular speed	rad/s
\dot{x}	Wheelchair speed	m/s
$F_L; F_R$	Left and right user force	N

Each cycle of the gesture is composed by two phases. During the traction phase the user pulls the cable. During the return phase the user goes back in the initial condition. Fig. 5 a) shows the beginning of the traction phase that coincides with the end of the return phase while the Fig. 5 b) shows the beginning of the return phase.

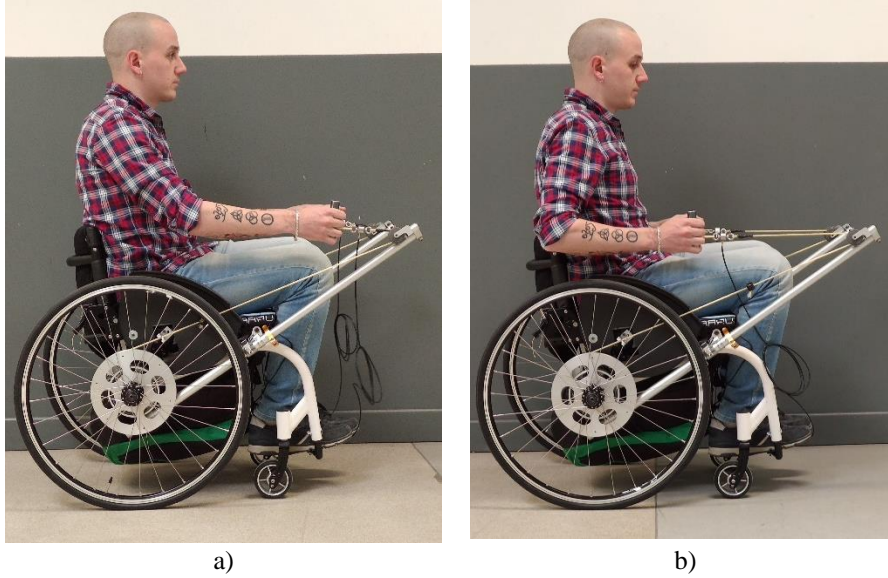

a) b)
Fig. 5. Prototype of Handwheelchair.q at the beginning
 a) of the traction phase, b) of the return phase

5 Results

Fig. 6 shows the first four cycles of the test. In general, the cycle time decreases. In fact, the first cycle time is more than 3 seconds while the fourth cycle time is approximately 1.5 s. The wheelchair starts moving when the user force $F_L + F_R$ reaches a specific level due to the static friction. For each cycle the maximum speed is reached at the end of the traction phase while the minimum speed is reached at the end of the return phase.

The wheelchair speed is determined as follows:

$$\dot{x} = \frac{\omega_{W,L} + \omega_{W,R}}{2} r_W \quad (1)$$

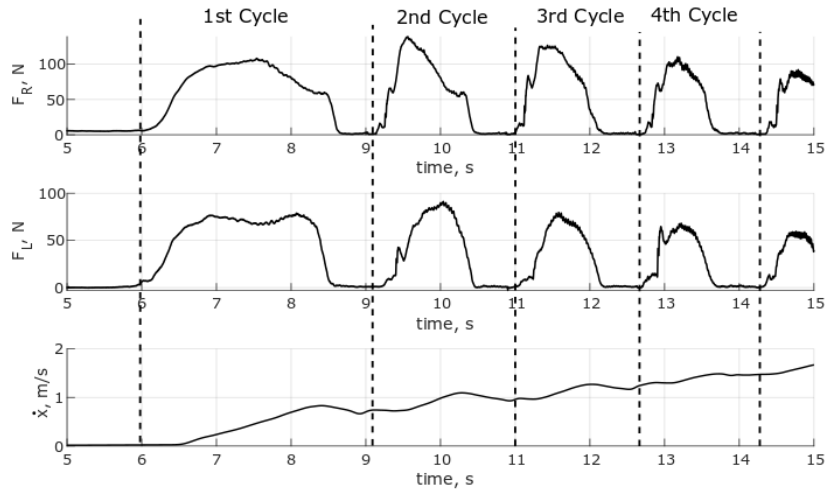

Fig. 6. User force and wheelchair speed during the acceleration phase

Fig. 7 shows the wheelchair speed and the user force during the steady-state phase.

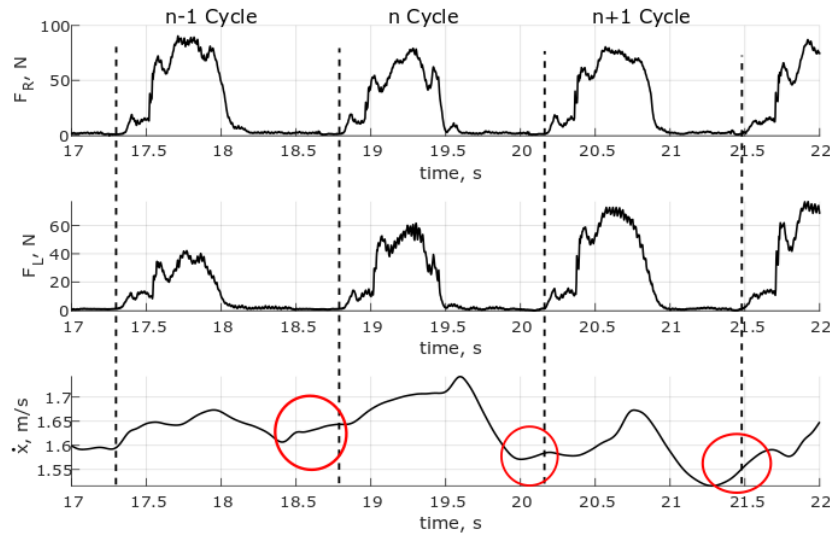

Fig. 7. User force and wheelchair speed during the steady-state phase

The red circles highlight an increment of the wheelchair speed at the end of the return phase. This increasing of speed is due to the dynamic action of the gesture. In fact, an additional test has been performed with the wheelchair positioned on the wheelchair trainer shown in Fig. 8.

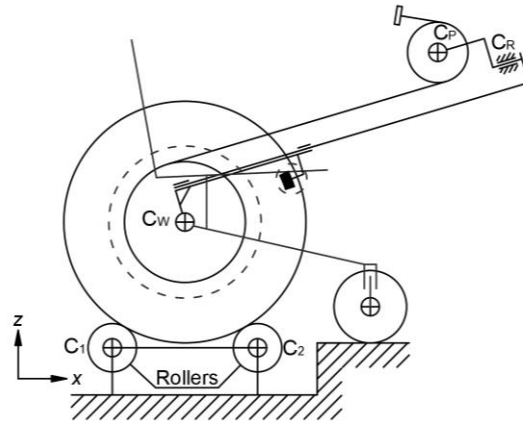

Fig. 8. Functional design of the wheelchair trainer

In Fig. 9 the results of the test with the wheelchair trainer are shown, there is not increasing of the speed before the traction phase. So, then, the increasing of the speed before the traction phase is due to the displacement of the center of mass of the user.

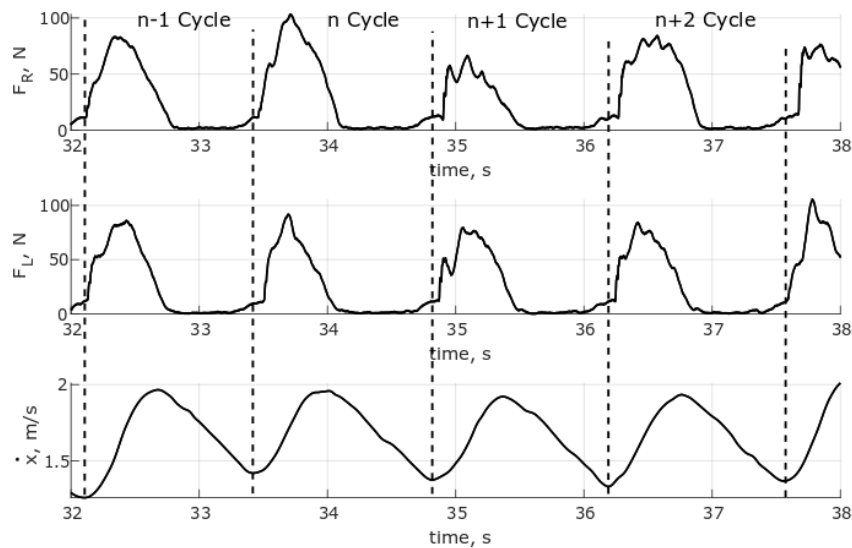

Fig. 9. Trainer test: user force and wheelchair speed during the steady-state phase

The user power has been determined as follows:

$$P = (F_L \omega_{W,L} + F_R \omega_{W,R}) r_P \quad (2)$$

The user power is shown in Fig. 10, the average power $P_{Avg} = 21,5 \text{ W}$ has been determined during the test in the range between 6 and 41 s.

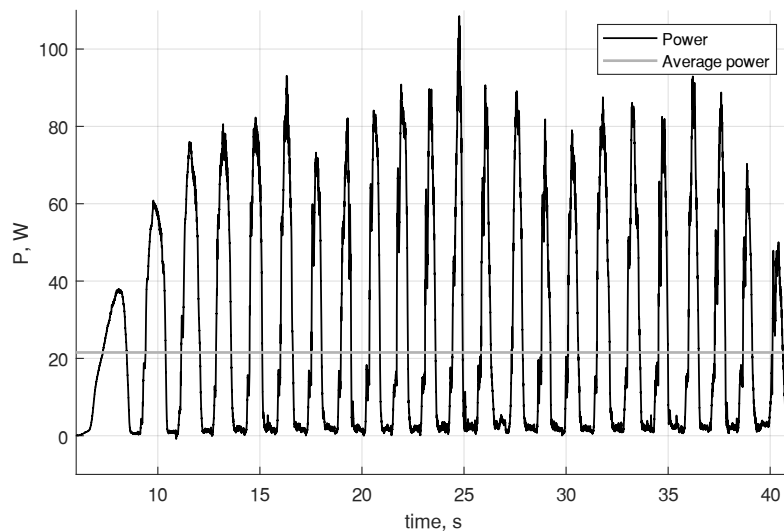

Fig. 10. User power during the test

6 Conclusions

The preliminary tests have shown the Handwheelchair.q speed related to the user force. This data can be possibly compared with alternative systems of propulsion for manual wheelchair. The user power is an evaluation index about the efficiency of the prototype. The influence of the gesture on the wheelchair speed deserves a deeper investigation. In general, the paper shows an interesting innovative and alternative system of propulsion for manual wheelchairs that can be employed for everyday life. The gesture can be a valid alternative to the hand-rim system in order to avoid or reduce the stress on the shoulder.

References

1. Toro, M. L., Eke, C., Pearlman, J.: The impact of the World Health Organization 8-steps in wheelchair service provision in wheelchair users in a less resourced setting: a cohort study in Indonesia. *BMC Health Services Research* 16, 26 (2015).
2. Liu, H., Pearlman, J., Cooper, R., Hong, E., Wang, H., Salatin, B., Cooper, R. A.: Evaluation of aluminium ultralight rigid wheelchairs versus other ultralight wheelchairs using ANSI/RESNA standards. *Journal of rehabilitation research e development*, 47(5), pp. 441-456 (2010).
3. Routier, F., Gagnon, B., Lemelin, B.: Effect of a wheelchair tires types and weight on wheelchair propulsion. In: *Annals of physical rehabilitation medicine*, 58(s), pp e21-e25 (2015).
4. Rice, I.: Recent salient literature pertaining to the use of technology in wheelchair sports. *Current physical medicine rehabilitation reports*, 4, pp. 329-335 (2016).

5. Guan, T., Lei, L., Li, J.: The human engineering analysis of racing wheelchair. *Advanced materials research*, pp. 2802-2806 (2014).
6. Litzensberger, S., Mally, F., Sabo, A.: Biomechanics of elite recumbent handcycling: A case of study. *Sport engineering*, 19, pp. 201-211 (2016).
7. Van Der Woude, L. H. V., Dallmeijer A. J., Janssen T. W. J.: Alternative modes of manual wheelchair ambulation: an overview. *American journal of physical medicine and rehabilitation*, 80, pp. 765-777 (2001).
8. Sarraj, A. R., Massarelli, R.: Design history and advantages of a new lever-propelled wheelchair prototype. *International journal advanced robotic system* (2011)
9. Arnet, U., Van Drongelen, S., Van der Woude, L. H. V., Veeger, D. H. E. J.: Shoulder load during handcycling at different incline and speed conditions. *Clinical biomechanics*, 27, pp. 1-6 (2012).
10. Quaglia, G., Bonisoli, E., Cavallone, P.: A proposal of alternative propulsion system for manual wheelchair. *International journal of mechanics and control*, 19, pp. 33-38 (2019).
11. Quaglia, G., Bonisoli, E., Cavallone P.: The design of a new manual wheelchair for sport. *Machines* 2019, 7(2), 31.
12. Quaglia, G., Bonisoli, E., Cavallone P.: Handwheelchair.q: Innovative manual wheelchair for sport. *Mechanisms and machine science*, 68, pp. 370-378 (2018).
13. Cavallone, P., Bonisoli, E., Quaglia, G.: Prototyping of manual wheelchair with alternative propulsion system. *Disability and rehabilitation: Assistive technology* (2019).