

Preliminary investigation on thermal behavior of vehicles in different climate conditions

Original

Preliminary investigation on thermal behavior of vehicles in different climate conditions / Campagnoli, E.; Mutani, G.. - ELETTRONICO. - (2019), pp. 103-108. (Intervento presentato al convegno Electrical and Power Engineering tenutosi a Budapest nel 20-21 Nov. 2019) [10.1109/CANDO-EPE47959.2019.9110983].

Availability:

This version is available at: 11583/2834725 since: 2020-06-11T10:43:45Z

Publisher:

IEEE

Published

DOI:10.1109/CANDO-EPE47959.2019.9110983

Terms of use:

This article is made available under terms and conditions as specified in the corresponding bibliographic description in the repository

Publisher copyright

(Article begins on next page)

Preliminary investigation on thermal behavior of vehicles in different climate conditions

Elena Campagnoli
Department of Energy
Politecnico di Torino
Torino, Italy
elena.campagnoli@polito.it

Guglielmina Mutani
Department of Energy, R3C
Politecnico di Torino
Torino, Italy
guglielmina.mutani@polito.it

Abstract— The objective of this paper is to provide an initial estimate, albeit rough, about the possible energy savings that can be achieved by reducing the use of the air condition system in cars. A simplified numerical model of the car has been created to predict the cabin temperature in different climatic conditions. In order to reduce the thermal load and so the temperature inside the cabin several different types of glazing have been considered, characterized by different absorbance coefficients and solar factors. Furthermore, two types of coatings with different absorbance coefficients were examined for the envelope. The paper describes the model used and reports the first results obtained.

Keywords—thermal model, moving vehicle, glass filters, coating colour, energy saving.

I. INTRODUCTION

The car is for sure for lots of people the most important transportation vehicle. Beyond the effects on air pollution due to the emission of exhaust gases, a secondary role, but not to be overlooked, is linked to the additional fuel consumption due to the use of the air conditioning system [1].

In hot weather, the solar radiation is responsible for heating the car cabin which leads to a discomfort condition for passengers. The common reaction to this unpleasant high temperature is the use of the air conditioning system in order to obtain the desired air temperature into the cabin, thus directly influencing fuel consumption.

This paper introduces a first simplified model for the evaluation of the thermal load of the cabin under different climatic conditions. In order to evaluate the possible benefits deriving from an attenuation of solar radiation, different glazing and coatings for the envelope were considered.

The modelling and simulation here presented were performed by using MATLAB Simulink. The basis of the model, the calculation with specific data, and further details will be dealt with in the following sections, where the thermal models for the glass, envelope and cabin are introduced.

The results obtained in terms of temperature of the glass, envelope and cabin and the expected energy savings are shown.

II. THERMAL MODEL OF THE VEHICLE

The model presented here aims to provide, in a simplified way, the thermal behaviour of the car cabin in different climatic conditions and has been developed using the following hypotheses. In the simulations car travels at 50 km/h and all windows are closed. The air conditioning system is

switched off and there is only the driver in the cabin. In order to simplify the modelling, the area affected by solar irradiation is considered independent of the angle of incidence of the radiation. This area for calculations is set, for both transparent and opaque surfaces, equal to half the total area of each part, considering that the direct component of solar radiation affects only a side of the vehicle. For the purpose of simplification, both the thermal conduction between the glass and the envelope and the heat dissipated by the engine in the passenger compartment are neglected.

The simulations were performed using MATLAB Simulink, considering the reference temperatures and solar irradiation for each month. This paper will only show results for July 17th, which represents typical hot summer conditions. For each city the solar irradiation, I , and the outside environment temperature T_e were obtained from on-line data available [2, 3]. Six cities were selected, at different latitudes, from northern Europe to Saudi Arabia.

The equations used for the model are reported in the following paragraphs and refer to three different sub-systems (Figure 1): the glasses, the envelope and the cabin. At the beginning, an equal temperature value is set for the three sub-systems. By using the Least Square Error method the convergence of the model is considered to be reached when the new final temperatures evaluated for the three systems are equal to the initial ones at less than 2%.

Data about vehicle materials were mainly obtained from a vehicle engineering technical manual [4].

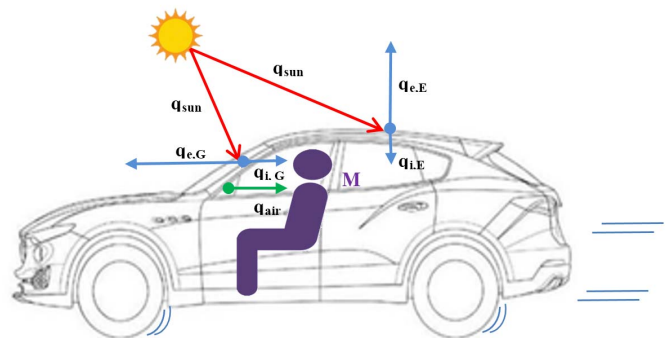

FIGURE 1. DIAGRAM OF THE THERMAL MODEL

A. Thermal balance of the glass

The energy stored in the car glasses changes during the hours of the day based on the variation of three different terms Eq. (1). This energy depends on the fraction of solar radiation absorbed and on the convective and radiative heat transfers

between the outside environment and both the car windows and the cabin, as reported in Eq. (1).

$$C_G \frac{dT_G}{dt} = \alpha_G A_{G,x} I - A_G \cdot G_e \cdot (T_G - T_e) - A_G \cdot G_i \cdot (T_G - T_C) \quad (1)$$

The term on the left side of Eq. (1) describes how the energy stored in the car glasses changes with the time of the day. The first term on the right side of the equation accounts for solar irradiation on the window panes. The other two terms refer to heat transfer between the windows and the outside environment the first and the windows and the cabin the second.

The thermal capacity of the glasses, $C_G=54,736$ J/K, is calculated considering the specific heat of the glass (795 J/kg/K); the sunny area is half of the total area of the windows of a common city car: $A_{G,x}=1.5$ m².

Different types of glazing with different values of the absorbance coefficient were considered. Table I shows the absorbance coefficients α_1 of the windshield and α_2 of the side and rear windows. Table II reports the average values α_G obtained combining the different glazing and weighting the absorbance on the areas of the different windows.

TABLE I. ABSORBANCE COEFFICIENTS OF THE GLAZING [5]

α_1	0.21	0.46	0.29
α_2	0.09	0.38	-

TABLE II. MEAN VALUES OF THE ABSORBANCE COEFFICIENTS

α_G	0.12	0.33	0.20	0.40	0.15	0.35

The overall heat transfer coefficients, G_e and G_i , have been set equal to the sum of the convective (h_C) and radiative (h_r) heat transfers coefficients. The calculation of h_C was performed by using the following equation [5, 6]

$$h_c = 1.163 \cdot (4 + 12\sqrt{v}) \quad (2)$$

where the wind speed, v , is 50 km/h for the outer side of the glass and 0.2 m/s [6, 7] for the inner side.

The equation used to determine the radiative heat transfer coefficient, h_r , is:

$$h_r = 4\varepsilon\sigma T_m^3 \quad (3)$$

where the emissivity of the surface ε is 0.9 and T_m is the mean temperature between the outside environment and the considered component i.e. the glass in Eq. (1).

The input data for the glass model are the glass temperature (T_G), the temperatures of the environment (T_e) and the cabin (T_C), the heat transfer coefficients for the inner (G_i) and outer (G_e) surfaces, and the intensity of the solar radiation (I). The output of the model is the first derivative of T_G with respect to time.

B. Thermal balance of the envelope

Equation (4) shows the energy balance for the envelope where, as already mentioned, the conduction heat transfer between the envelope and glass is neglected.

$$C_E \frac{dT_E}{dt} = \alpha_E A_{E,x} I - A_E \cdot G_e \cdot (T_E - T_e) - A_E \cdot G_i \cdot (T_E - T_C) \quad (4)$$

The term on the left side of Eq. (4) describes how the energy stored in the envelope changes with the time of the day. Similarly to Eq. (1), the first term on the right side of the equation takes into account the solar irradiation on the

envelope while the other two terms refer to the heat transfer between the envelope and the external environment the first and the envelope and the cabin the second.

Also for the envelope the radiative properties are of primary importance. In particular the colour of the coating influences the thermal transmission through this component. Two different coatings were considered (see Table III) for the following calculations [8, 9].

TABLE III. ABSORBANCE COEFFICIENTS OF THE ENVELOPE

	Black coating	White coating
α_E	0.95	0.16

The area $A_{E,x}$ that receives the solar gain, as in the glass model, is half of the total envelope area $A_E=1.62$ m². The thermal capacity of the envelope is calculated considering for both the roof and the pillars a three-layer system.

This sandwich is composed of a rigid steel substrate, an intermediate cushion layer and a decorative layer both made of PP-T20 (general polypropylene filled with 20% talcum). Based on the thermo-physical properties reported in the literature for these layers, the thermal capacity for the envelope was estimated to be equal to $C_E=83,283$ J/K.

The method for calculating the heat transfer coefficients G_e and G_i is the same as described above for glass, except for the calculation of the average temperature for which the temperature of the envelope must be considered instead of the temperature of the glass.

The input data for the envelope model are the envelope temperature (T_E), the environment temperature (T_e) and the cabin temperature (T_C), the heat transfer coefficients for the inner (G_i) and outer (G_e) surfaces and the intensity of the solar radiation (I). The output of the model is the first derivative of T_E with respect to time.

C. Thermal balance of the cabin

Compared to the thermal systems discussed above, Eq. (5) for the cabin, is a bit more complicated:

$$C_C \frac{dT_C}{dt} = g_G A_{G,x} I - A_G \cdot G_{i,G} \cdot (T_C - T_G) - A_E \cdot G_{i,E} \cdot (T_C - T_E) + M - \dot{m} c_{air} (T_C - T_e) \quad (5)$$

The term on the left side of Eq. (5) describes how the energy stored in the cabin changes with the time of the day. Regarding the thermal capacity of the cabin various components must be considered: four seats, the dashboard, four doors, the car floor and the air contained in the cabin. Based on these components the thermal capacity of the cabin, C_C , was set to 382,331 J/K.

The first term on the right side of the equation, thanks to the solar factor, also called total solar energy transmittance, g_G , allows to calculate the total energy transmitted through the glazing which is the sum of the solar radiation transmitted directly and the portion of energy absorbed by the glass that is then emitted into the cabin. Table IV contains some values, available in the literature [5, 10], for the solar factor of both the windshield and the rear and side windows. Table V reports coefficients of the solar factor used for the simulations. These values were obtained by combining and weighting, on the appropriate areas, the different numerical values for g_1 and g_2 shown in Table IV.

TABLE IV. SOLAR FACTOR COEFFICIENTS

Windshield g_1	0.84	0.75	0.51
Side and rear windows g_2	0.84	0.65	-

TABLE V. SOLAR FACTOR COEFFICIENTS

g_g	0.84	0.71	0.81	0.68	0.74	0.61
-------	------	------	------	------	------	------

The following two terms refer to the heat transfer between the cabin and the glass (the first), and the cabin and the envelope (the second). The method for calculating the heat transfer coefficients $G_{i,G}$ and $G_{i,E}$ is the same as described above. For the calculation of $G_{i,G}$ the average temperature between the cabin and the glass must be considered while for the calculation of $G_{i,E}$ the average temperature must be calculated considering the cabin and the envelope.

The fourth term is the metabolic rate of the driver [11, 12], $M=100$ W. The last term refers to the air entering the cabin at $v = 0.2$ m/s through six nozzles, with a total area equal to 50 cm², placed on/near the dashboard.

The input data for the cabin model are the temperatures of the glass, envelope, cabin and environment, the heat transfer coefficients and the intensity of the solar radiation I . The output of the model is the first derivative of T_C with respect to time.

The entire thermal model is represented in Figure 2. The input data for this system are the glass temperature (T_G), the outside environment temperature (T_e), the cabin temperature (T_C), the internal and external surface heat transfer coefficients (G_i and G_e), and the intensity of the solar radiation (I). The derivatives of T_G , T_C , T_E are obtained at once for all the subsystems: glasses (green box), envelope (grey box) and cabin (blue box), as shown in Figure 2. In Simulink environment, it is possible to perform the integration of the three differential equations, thus obtaining the values of T_G , T_C and T_E .

III. RESULTS AND DISCUSSION

The cities chosen for the model must be representative of different environment conditions. For this reason, cities

located at different latitudes or in different climate zones have been considered as case studies (Table VI): Reykjavik in Iceland, Milan, Rome, Messina in Italy, Cairo in Egypt, and Riyadh in Saudi Arabia.

TABLE VI. LATITUDE AND LONGITUDE OF THE CITIES

City	Latitude	Longitude
Reykjavik	N 64°08'	E 21°53'
Milan	N 45°37'	E 08°43'
Rome	N 41°47'	E 12°34'
Messina	N 38°12'	E 15°33'
Cairo	N 30°07'	E 37°23'
Riyadh	N 24°42'	E 46°47'

Hourly weather data was downloaded from the EnergyPlus on-line database [3].

The simulation and modelling in MATLAB Simulink environment allows to integrate the coupled equations that represent the three thermal systems, supplying the graphs of the temperature variations versus time. For each city, the results showed how the temperature inside the vehicle cabin varies by changing the envelope coating or glazing type. The analysis of temperature variations allows to draw some preliminary conclusions about energy savings that can be obtained depending on the Cooling Degree Days (CDD) [13].

A. Temperature results

For each combination of glass and colours of the envelope coating, the results illustrate the variation of the temperature both of the air in cabin, and of the glass and envelope. By plotting the graphs for each kind of glass combination, this work focuses on comparing the cabin temperature in different conditions, which is directly related to human comfort in the driving environment.

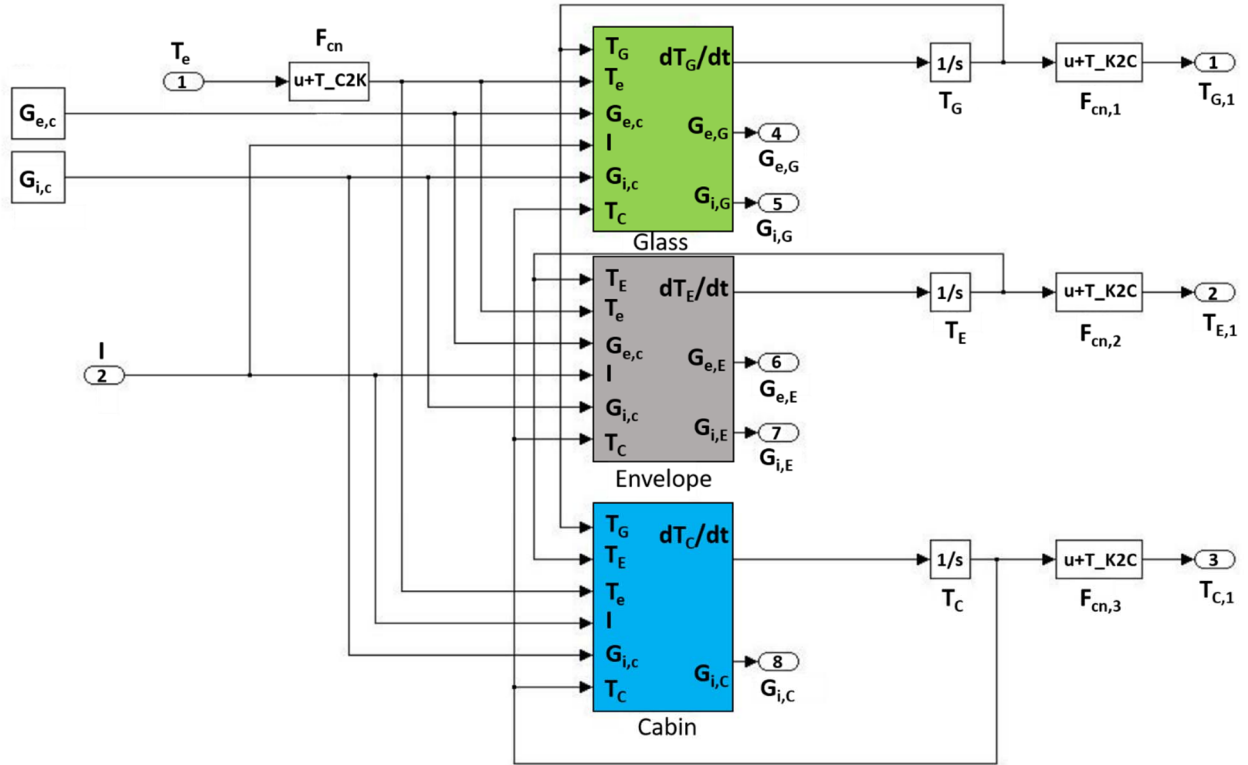

FIGURE 2. THERMAL MODEL OF THE VEHICLE (Glass, Envelope and Cabin)

Figures 3 and 4 show, for the cities of Milan and Messina, the case of a car with a black coated envelope and clear glasses without solar control technology ($g=0.84$). From the comparison of the figures, as can be expected, we can see that the temperatures of the three systems considered (glass, envelope and cabin) are, independently of the time of day, higher for the city of Messina which has a higher solar irradiation.

In addition, both graphs show a time lag between the peak of solar radiation and the maximum temperature values recorded both for the three examined systems and for the outdoor air temperature.

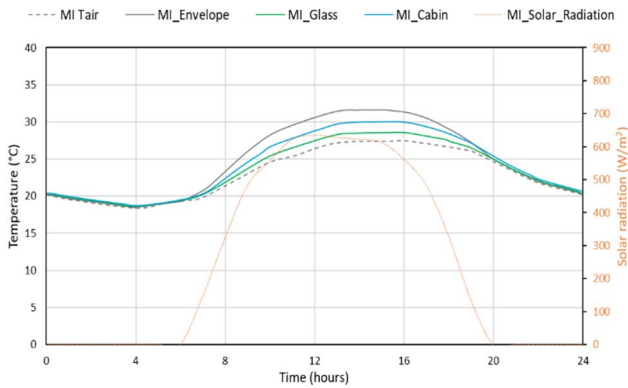

FIGURE 3. CABIN TEMPERATURE FOR A BLACK CAR WITH $g_1=0.84$ and $g_2=0.84$ IN MILAN

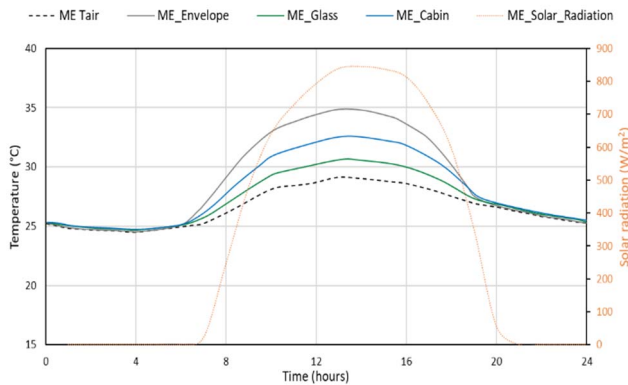

FIGURE 4. CABIN TEMPERATURE FOR A BLACK CAR WITH $g_1=0.84$ and $g_2=0.84$ IN MESSINA

Figures 5 and 6 show how the various types of glass, with the same colour of the envelope, can influence the thermal balance of a vehicle in Milan and Messina.

In particular, Figures 5 and 6 illustrate how the air temperature in the cabin of a black car varies with respect to different glazing types. The label in the Figures lists the combination of the different solar factors of the glass.

In both Figures it can be seen that the highest temperature is not reached when $g_1=0.84$ and $g_2=0.84$, but in the case with $g_1=0.75$ for the windshield and $g_2=0.84$ for the side and back windows with an average value $g_G=0.81$.

This behaviour is due to the fact that, although the solar factor of this combination is not the highest, its average absorbance is $\alpha_G=0.21$, a relatively high value. This means that the glass can absorb more solar energy, warming up more and subsequently releasing more heat into the passenger compartment.

On the basis of this observation, it is evident that for a good level of comfort in the passenger compartment it is necessary that the solar control glass not only has a low solar factor, but also a limited absorption.

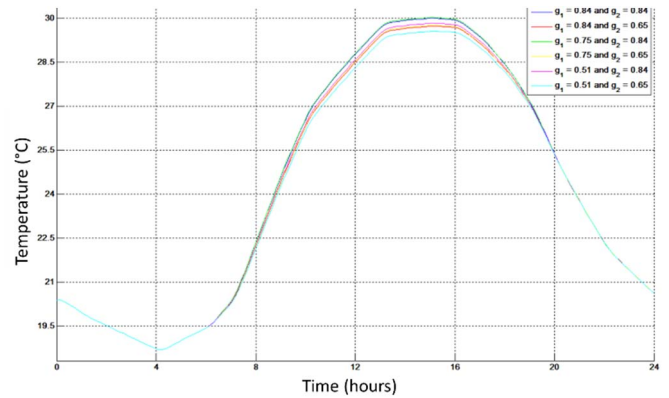

FIGURE 5. CABIN TEMPERATURE FOR A BLACK CAR WITH DIFFERENT GLAZING TYPES IN MILAN

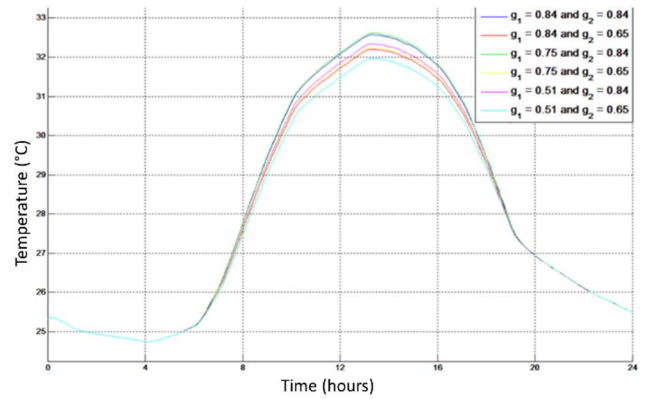

FIGURE 6. CABIN TEMPERATURE FOR A BLACK CAR WITH DIFFERENT GLAZING TYPES IN MESSINA

Figure 7 shows the effect of the envelope colour on the cabin temperature for the city of Reykjavik. The figure shows how, with the same type of glass ($g_G=0.84$), the temperature of the cabin of a white car is about 0.5°C lower than that of a black car. Unlike the other cities analysed, these results show that in this city clear glasses and a dark coating colour are recommended.

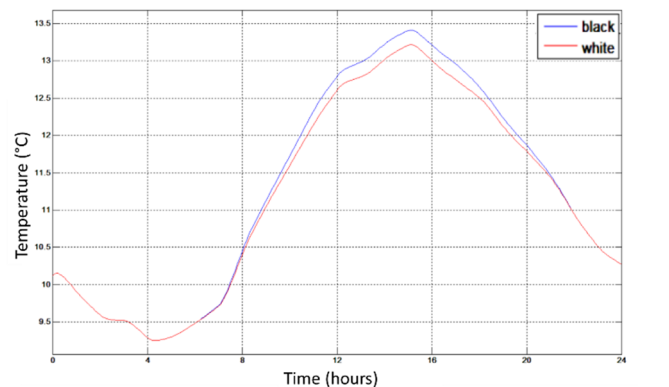

FIGURE 7. CABIN TEMPERATURE FOR DIFFERENT COATINGS IN REYKJAVIK

Figures 8 shows the temperature trends, for the three systems considered, in the case of a black car with $g_1=0.84$ and $g_2=0.84$ for the cities of Messina, Milano and Riyadh. For all three cities, the highest temperatures are those reached by

the envelope, while the compartment temperatures are in any case in an intermediate position. Due to the higher solar radiation, the temperature values of the three systems examined are higher in the case of Riyadh and decrease at increasing latitudes.

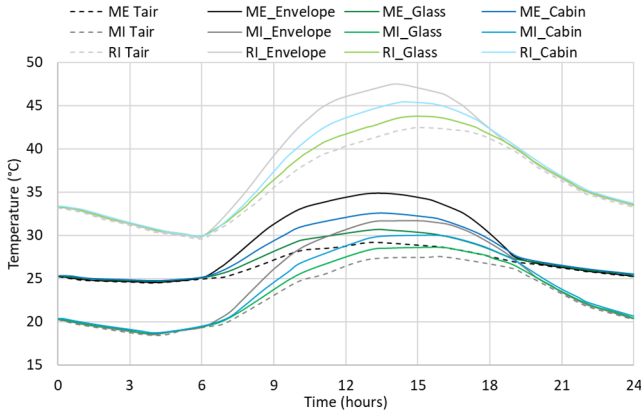

FIGURE 8. TEMPERATURES FOR A BLACK CAR WITH $g_1=0.84$ and $g_2=0.84$: COMPARISON BETWEEN MESSINA, MILAN AND RIYADH

Figure 9 shows the cabin temperature for a black car with two types of glazing ($g_1=0.84$, $g_2=0.84$; $g_1=0.51$, $g_2=0.65$), comparing the Reykjavik data with those of Messina, Milano and Riyadh.

As already pointed out, with the same colour of envelope and type of glass, the city of Riyadh, characterized by greater solar radiation, records the highest temperatures for the air inside the passenger compartment. Comparing the two types of glazing it is interesting to note that with a reduction of the solar factor of about 30%, the temperature of the cabin air is reduced only by about 3% (case of Riyadh) or less. This fact, as already discussed in the comparison between Figures 5 and 6, is due to the average absorption coefficient (α_G) of the glass, which is equal to 0.12 in the first case and 0.35 in the second.

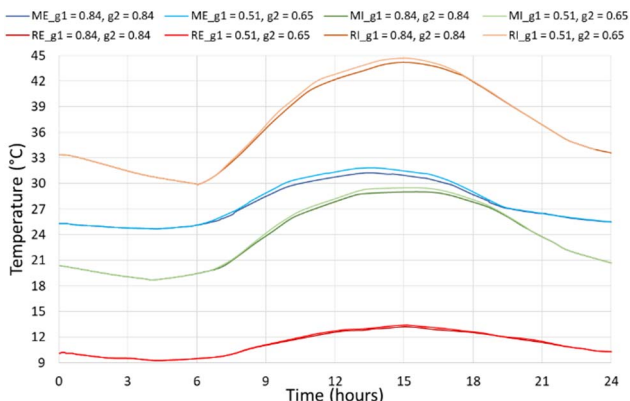

FIGURE 9. CABIN TEMPERATURE FOR A BLACK CAR WITH TWO TYPES OF GLAZING: COMPARISON BETWEEN REYKJAVIK, MESSINA, MILAN AND RIYADH

Figure 10 shows how the cabin temperature can also be slightly reduced by changing the colour of the vehicle. Using the same solar factor, in the case of a black car, the cabin temperature reaches, in the early hours of the afternoon, respectively 32 °C in Messina and 29.5 °C in Milan, while in the case of a white car the recorded temperatures drop about half a degree (31.5 °C in Messina and 29 °C in Milan).

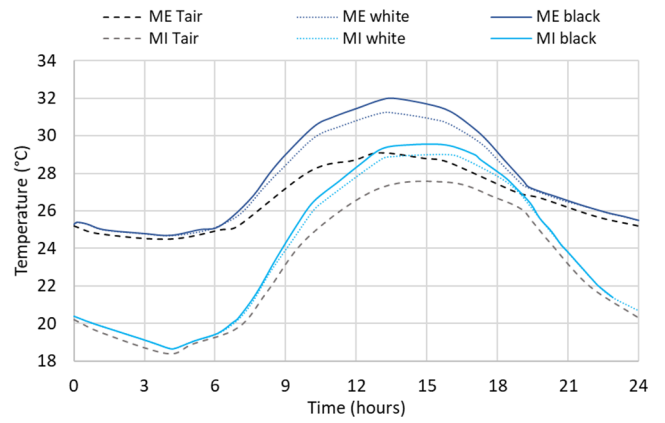

FIGURE 10. CABIN TEMPERATURE FOR BLACK AND WHITE CAR: COMPARISON BETWEEN MESSINA AND MILAN

B. Evaluation of energy savings

The investigation on the thermal comfort in the cabin during the summer is aimed at finding an appropriate way to reduce fuel consumption for air conditioning, while ensuring adequate comfort for passengers.

The concept of degree days is a tool that can be used to evaluate and analyse the energy consumption related to weather conditions for indoor environments. This method can be applied to both heating and cooling systems.

In this article, using the concept of cooling degree day (CDD), we want to assess how much the amount of fuel consumed for cooling the cabin can be reduced by using different colours for the envelope and different types of glass. One of the major problems in applying this method is the definition of the so-called base temperature, which affects the accuracy of the energy consumption assessment. The "base temperature" is the outside temperature above which it is necessary to activate the air conditioning system [13].

The comfort temperature in a city like Milan is fixed in summer at 26 °C [11], so it could be considered the target temperature for the cabin. The air conditioning system, in reality, to guarantee the internal temperature of 26 °C, must spend more energy due to additional thermal loads such as the heat dissipation of the engine and of other electric appliances not considered in the model described here. This effect can be considered with a higher temperature of about +2-3 °C and, consequently, the inlet air temperature for the cabin was assumed 22 °C [14].

For the cities of Milan, Rome and Messina the CDD were calculated considering the average hourly and daily temperatures from June to August [3].

Energy saving by using solar control glazing

Using the method described above, the two cases characterized by the maximum and minimum value of the solar factor g_c were compared. The maximum value, equal to $g_c=0.84$, represents the case of clear glasses while the minimum value refers to glasses with solar control and $g_c=0.61$. The percentage energy savings can be calculated comparing the CDD without and with solar control solutions (Table VII):

$$\text{Energy savings} = (\text{CDD} - \text{CDD}_{\text{new}}) / \text{CDD}. \quad (6)$$

TABLE VII. ENERGY SAVINGS WITH SOLAR CONTROL GLASSES

City	CDD reduction, °C	Energy savings, %
Milan	17.32	9.12
Rome	20.16	6.46
Messina	34.13	8.54

Energy saving due to the color of the envelope coating

Since, as previously seen, also the colour of the envelope coating influences the cabin temperature, the energy saving deriving from the different colour of the car has been calculated.

TABLE VIII. ENERGY SAVINGS WITH BLACK OR WHITE ENVELOPE

City	CDD reduction, °C	Energy savings, %
Milan	20.60	10.9
Rome	24.12	7.73
Messina	41.21	10.30

On the basis of the results obtained, it is clear that in cities where air conditioning is needed for cooling during the summer, it's recommended to have a car with a light colour envelope and a solar control glass. For the side and rear windows many car manufacturers already use solar control glasses and on cars that do not take advantage of this technology it is not uncommon for people to apply a layer of solar control film to the original clear glass. In addition, since the windshield occupies most of the area from which the sun enters the cabin, choosing a laminated glass with a solar control film interposed would reduce the need for cooling and consequently increase energy savings.

IV. CONCLUSIONS

Based on the reported results, it is possible to draw some conclusions on the main aspects related to thermal comfort inside a cabin in different climate conditions.

First of all, the greenhouse effect inside a car is primarily due to the solar radiation entering the cabin by direct transmission or re-emission of the radiation absorbed by the glazing. A coloured glass or one with solar control coatings can reduce this heat input to the cabin.

In this case, based on the results obtained, the cabin temperature can be reduced by $0.3 \div 0.5$ °C, compared to a car with transparent windows, but especially the fuel consumption for cooling could be reduced by about 9 %.

According to the investigation on Italian cities, a car with a white coating allows energy savings of around 7 %.

Even with a fairly simplified model, such as the one presented here, it is possible to note that the achievement of the comfort conditions in the cabin, and in parallel the energy saving, can be obtained by applying a solar control glass.

In order to improve the model and obtain more precise results, different aspects should be considered in further studies. First of all, in the thermal model both the area of the glass and that of the envelope that receive solar radiation are considered half of the total surface. In reality, when the car is exposed to solar radiation, the angle of incidence varies over time, so the receiving area should change accordingly.

Furthermore, the radiative heat transfer coefficient h_r , which is part of the heat transfer coefficients G_i and G_e , is

derived from that for buildings, for the future an accurate study should be performed. Last, but not least, for the thermal system of the cabin, it would be necessary to evaluate the heat dissipated by the engine in the passenger compartment, since this could significantly affect thermal comfort.

ACKNOWLEDGMENT

The authors are grateful to the following students in Automotive Engineering for their help in characterizing the cabin, glasses and envelopes of European vehicles and in evaluating different thermal models: Wang Bojun, Tong Yifei and Tong Meng.

REFERENCES

- [1] G. Fontaras, N.G. Zacharof, B. Ciuffo, "Fuel consumption and CO2 emissions from passenger cars in Europe – Laboratory versus real-world emissions, Progress in Energy and Combustion Science", Volume 60, 2017, Pages 97-131, doi: 10.1016/j.pecs.2016.12.004.
- [2] Photovoltaic Geographical Information System (PVGIS), EU SCIENCE HUB, JRC, available at: <https://ec.europa.eu/jrc/en/scientific-tool/pvgis>.
- [3] EnergyPlus weather database, available at: <https://energyplus.net/weather>.
- [4] R. Bosch GmbH, "Bosch Automotive Handbook- 10th edition", Wiley Ed.
- [5] A. Mezrhab, M. Bouzidi, Computation of thermal comfort inside a passenger car compartment, Applied Thermal Engineering 26 (2006) 1697–1704.
- [6] UNI EN ISO 6946:2018 "Componenti ed elementi per edilizia - Resistenza termica e trasmittanza termica - Metodi di calcolo", UNI Ente Nazionale Italiano di Unificazione, Italian Standard (in Italian).
- [7] M. Bohm, I. Holmer, "Thermal effect of glazing in driver's cabs" – Evaluation of the impact of different types of glazing on the thermal comfort, JTI, 2002
- [8] H. Akbari, "Coatings for Cool Vehicles", Heat Island Group, International Energy Agency, Paris, October 24, 2016.
- [9] D. Kristanto, T. Leephakpreeda, Sensitivity analysis of energy conversion for effective energy consumption, thermal comfort, and air quality within a car cabin, Energy Procedia 138 (2017), 552-557
- [10] AGC Glass Europe tool, available at: <https://www.agc-yourglass.com/gb/en/products>.
- [11] X.Zhou, D.Lai, Q.Chen, Experimental investigation of thermal comfort in a passenger car under driving conditions, Building and Environment 149 (2019), 109-119.
- [12] P. Danca, A. Vartires, A. Dogeanu, An overview of current methods for thermal comfort assessment in vehicle cabin, Energy Procedia 85 (2016) 162 – 169.
- [13] Heating and cooling of buildings – Climatic data – Part 3: Accumulated temperature differences (degree-days) and other indices, Italian Standard UNI 10349-3.
- [14] Y. Mao, J. Wang, J. Li, Experimental and numerical study of airflow and temperature variations in an electric vehicle cabin during cooling and heating, Applied Thermal Engineering 137 (2018) 356–367.