

Development of an Equilibrium-based Model of Gasification of Biomass by Aspen Plus

Original

Development of an Equilibrium-based Model of Gasification of Biomass by Aspen Plus / Gagliano, A.; Nocera, F.; Bruno, M.; Cardillo, G.. - In: ENERGY PROCEDIA. - ISSN 1876-6102. - ELETTRONICO. - 111:(2017), pp. 1010-1019. (8TH INTERNATIONAL CONFERENCE ON SUSTAINABILITY IN ENERGY AND BUILDINGS, SEB-16 Politecnico Torino, Turin, ITALY SEP 11-13, 2016) [10.1016/j.egypro.2017.03.264].

Availability:

This version is available at: 11583/2812779 since: 2020-04-16T16:35:08Z

Publisher:

Elsevier Ltd

Published

DOI:10.1016/j.egypro.2017.03.264

Terms of use:

This article is made available under terms and conditions as specified in the corresponding bibliographic description in the repository

Publisher copyright

(Article begins on next page)

8th International Conference on Sustainability in Energy and Buildings

Development of an equilibrium-based model of gasification of biomass by Aspen Plus

A. Gagliano^{a*}, F. Nocera^a, M. Bruno^a, G. Cardillo^a

^aIndustrial Engineering Department, University of Catania, Viale A. Doria n.6, 95125 Catania, Italy

Abstract

Agricultural and forestry residues are usually processed as wastes; otherwise, they can be recovered to produce electrical and thermal energy through processes of thermochemical conversion, such as torrefaction, pyrolysis and gasification.

Currently, the gasification of residual biomass for producing neutral CO₂ fuel for energy production is in development stage. In this context, this study proposes an equilibrium-based model, developed by the commercial software Aspen Plus, of a co-current gasifier fueled with agriculture residual, which allows estimating the chemical composition and the heating value of the syngas produced. The prediction of such model includes the main gaseous species, the yields of char and tar and describes the gasification process through the mass and energy balances, the water-gas shift (WGS) and the methanation reaction.

The model validation was carried out through the comparison with experimental data, concerning two biomass with different moisture content and different gasification conditions, for sixteen cases compared.

Overall, the comparison between the results of the simulations and the experimental data have shown a good agreement.

© 2017 The Authors. Published by Elsevier Ltd. This is an open access article under the CC BY-NC-ND license

(<http://creativecommons.org/licenses/by-nc-nd/4.0/>).

Peer-review under responsibility of KES International.

Keywords: Modeling; Aspen Plus; Downdraft gasification; Equivalent ratio; Moisture Content; Biomass

1. Introduction

Biomass gasification coupled with advanced power generation systems such as gas turbines or fuel cells can satisfy many EU objectives [1,2], such as the increase of the use of renewable energy, energy efficiency, security of supply (indigenous resource), and reduction of greenhouse gas emissions.

* Corresponding author. Tel.: 0957382451.

E-mail address: agagliano@dii.unict.it

The aim of the biomass gasification process is to convert solid biomass fuels into a medium heating value syngas. Biomass reacts with a combustive agent (air, oxygen, steam), which provide oxygen to the process, thus by the thermal cracking and the partial oxidation produce the so called “syngas”. Charcoal, ash with varying carbon contents (char) and condensable low molecular hydrocarbons (tar) are produced besides the produced gas. The chemical composition of syngas depends by the biomass fuel, the reaction conditions and the combustive agent.

In fixed bed gasifier, the biomass fuel moves from the top to the bottom of the fuel bed resulting in relatively long residence times, moreover such typology of gasifiers is classified into co-current, counter-current or cross flow gasifiers, depending by relative flow between the produced gas and the fuel transport. Figure 1 shows a co-current (downdraft) fixed bed gasifier and the characteristic reaction zones of this typology of gasifier: drying, pyrolysis, oxidation and reduction.

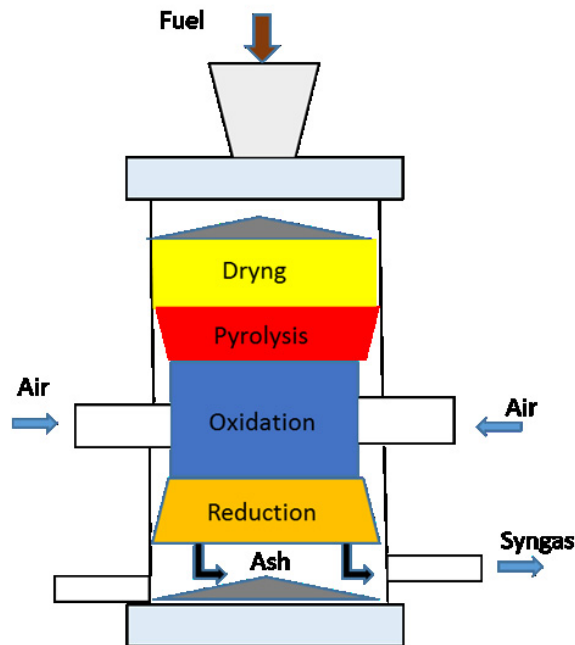

Fig. 1. Scheme of a downdraft gasifier.

Downdraft gasifiers produce syngas with low tar content (1-5%), in comparison with other typologies of gasifiers. [3, 4], so they can reduce the efforts for gas cleaning to be suitable for engines and gas turbines.

Every biomass type has carbon, hydrogen, and oxygen as major chemical constitutive elements, which can be quantized by the ultimate analysis using the $C_xH_yO_z$ formula where x, y, and z represents the elemental fractions of C, H, and O respectively. Moreover, the proximate analysis gives the composition of the biomass in terms of gross components such as moisture (MC), volatile matter (VM), ash (ASH), and fixed carbon (FC).

Since there is a lack of appropriate models able to predict the composition of the syngas produced through the gasification process[5], this paper presents an equilibrium-based model developed in Aspen Plus (Advanced System for Process Engineering) that allows of predicting the chemical composition of the producer gas in function of the gasification process design. Aspen Plus is equipped with a large database of chemical compounds and a property estimation system for calculating the stream thermodynamic properties and chemical reactions.

Aspen Plus was widely used by many researchers for simulating the biomass gasification [6-10].

Mansaray et al. [11] applied Aspen Plus to simulate rice husk gasification using chemical equilibrium relations and energy balances. Mathieu and Dubuisson [12] modeled wood gasification in a fluidized bed gasifier. Nikoo and Mahinpey [13] developed a model which predicts the steady-state performance of an atmospheric fluidized-bed

gasifier considering the hydrodynamics and reaction kinetics simultaneously. Doherty et al. [14, 15] developed a model for a circulating fluidized bed and studied the effect of various operative conditions.

More specifically, the proposed model is able to predict the chemical composition and the lower heating value (LHV) of the producer gas, in function of the chemical composition and the moisture content of biomass, the equivalent ratio (*ER*) and the gasifier temperature.

2. Materials and methods

The proposed model was developed following different steps, which were: identification of the process phases; selection of the model blocks available in Aspen Plus for representing each phase; link between the selected block; setting of the operative parameters; validation and calibration of the developed model on the basis of experimental data.

Moreover, the model is based on the assumptions that:

- the blocks are implicitly considered zero dimensional and perfectly thermally isolated;
- the blocks are characterized by perfect mixing and uniform temperature;
- residence time is long enough to reach the thermodynamic equilibrium in the R-Gibbs block;
- the gases behaviour is considered ideal, due to the high temperature and the low pressure.

In the software, the biomass fed to the gasifier is characterized by its ultimate and proximate analyses and not by its chemical formula [10], as it is classified as a non-conventional stream. The tool HCOALGEN and DCOALIG use the proximate analysis, ultimate analysis, and sulphur analysis to calculate the lower heating value (*LHV*), formation enthalpy (HCOALGEN) and density (DCOALIG) of the biomass (non-conventional component) [16].

Thus, the stream thermodynamic conditions of biomass (pressure = 1.0 bar and temperature = 25 °C) and mass flow rate were set. The Peng Robinson [17] equation (see eq. 1) was used to estimate all physical properties of the conventional components produced by the gasification process (e.g. H₂, CO, CO₂, CH₄, H₂O).

The pressure (*p*) is related to the temperature (*T*), ideal gas constant (*R*) and molar volume (*V*) via:

$$p = \frac{RT}{V-b} - \frac{a(T)}{V(V+b)+b(V-b)} \quad (1)$$

The parameter “a” is a measure of the attractive forces between the molecules, and “b” is related to the size of the molecules. The advantages of this equations are that they are easy to use and that they often accurately represent the relation between temperature, pressure, and phase compositions in binary and multicomponent systems.

In Aspen Plus there is not a specific block able to represent the gasification reactor, hence a combination of two or more blocks is necessary for modeling the downdraft gasifier. According with literature studies [19-21], the gasification process was modeled through two reactors: the R-Yield and the R-Gibbs block.

The R-Yields block simulates the biomass devolatilization, (i.e. the drying and the pyrolysis zones of the gasifier (see Fig. 1)), where the biomass is broken down into simpler components and converted from non-conventional component to conventional components (H₂, CO, CO₂, CH₄ and H₂O). This block calculates the yield distribution of the above-mentioned volatilization products without the need to specify the reaction stoichiometry and kinetics [21].

R-Gibbs block calculates chemical equilibrium and phase equilibrium by minimizing the Gibbs free energy of the system. Before feeding the biomass into the R-Gibbs block, it must be decomposed into conventional elements using the R-Yield reactor.

Thus, the R-Gibbs block was used to simulate the oxidation and the reduction zones in the gasification reactor.

A Mixer block was used to mix the products of the R-Yield reactor (DECOMP) with the flow of air, in sub-stoichiometric quantity, before the inlet in the R-Gibbs block.

Figure 2 shows the flow sheet of the gasification model developed by Aspen Plus.

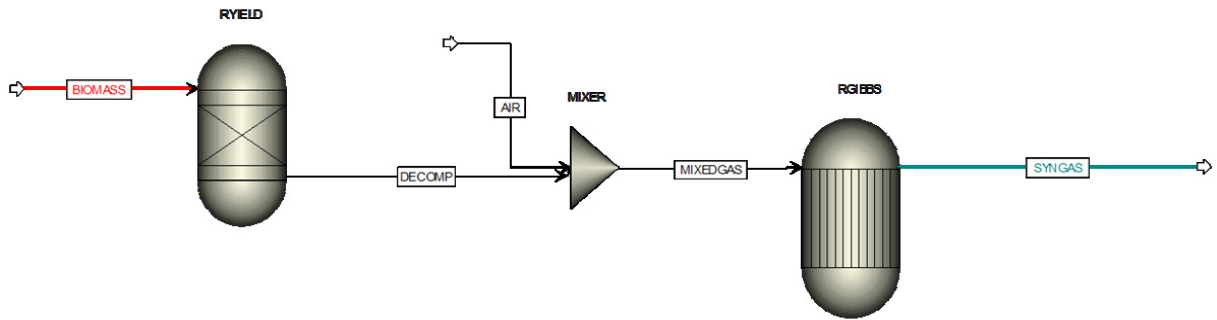

Fig. 2. Flow sheet of the model developed by Aspen Plus software.

The individual products yield of the R-Yield block, were evaluated using a “calculator block”[22], that is a subroutine written in Fortran language defined by the user in order to estimate the products yields of volatilization on the basis of the biomass ultimate and proximate analysis. Moreover, it needs of the definition of initial values of the products yields, that were carried out by the study of [23], concerning the volatilization of different lignocellulosic biomasses, as a function of the temperature.

In the R-Gibbs reactor, the chemical equilibrium reactions used in the gasification process have been selected, that were the methanation (2) and the water-gas shift (WGS) reaction (3):



Methanation is a chemical reaction that converts carbon monoxide and/or carbon dioxide to methane. The WGS convert CO and H₂O into additional H₂ and carbon dioxide, the reaction does not change molar totals and therefore the effect of pressure on the reaction is minimal.

The tar and char yield estimation is a difficult task through a thermodynamic equilibrium model, because tar is typically a non-equilibrium product.

Since the predictions of the mathematical models are improved substantially when the tar formation is included [24-26], in this study, tar and char yields were considered as input parameters, and fixed independently by the gasifier operating conditions, in accordance with other literature models [27, 28]. Thus, they were set, as inert components, in the R-Gibbs reactor.

As well known, to achieve a high carbon conversion of the biomass and a low tar content, a high operating temperature (>800°C) in the gasifier is recommended. Operating temperature of about 900 ÷ 1000°C causes the tar cracking, thus the tar content decreased sharply (4 ÷ 5% mass percentage) [29, 30] and, above all, its production should be almost constant, independently by the oxidation air supplied. In the model approach a tar yield percentage of 4.5% was fixed independently by the operating parameters, since this value allowed to obtain the best agreement with the experimental data.

At high temperatures, as the ones examined, char and tar yields are very modest, whereas the gas yield is very high [15, 31]. In accordance with the typical products yields suggested by Bridgewater [32] (syngas yield 85%wt of the feedstock) the char yield was posed equal to 10.5% (mass percentage).

The tar was stated as “C₆H₆” [33-37] with the same thermochemical properties of benzene [34, 38], while the char was stated as carbon with the thermochemical properties of graphite [34-36, 39].

Table 1 describes the blocks used to develop the model, and the settings made (i.e. operative conditions).

Table 1. Description of the reactor blocks used in the simulation.

| Reactor block | Description of characteristics | Settings |
|---------------|--|---|
| R-Yields | Models a reactor by specifying the reaction yields of each component. This reactor is useful when the reactions stoichiometry and kinetics are unknown and yields distribution data are available. | Pressure 1 atm; Temperature 500 °C; Individual product yields of the volatilization process [33]. |
| R-Gibbs | Models single-phase or simultaneous phases chemical equilibrium, on the basis of mass balances, by minimization of the Gibbs free energy. This model is useful when temperature and pressure are known and the reactions stoichiometry is unknown. | Pressure 1 atm; Temperature 1100 K and 1250 K secondly of the biomass simulated; Water-gas shift and methanation reactions with temperature approach; Thermochemical property of tar and char. Tar and char yields set as inert components. |
| Mixer | Models the mixing of different streams inlet into a block. | - |

3. Tuning of the model

3.1. Experimental data

The developed model was calibrated comparing the results of the simulation with the experimental data of Barrio and Fossum [40] which were conducted on pellets (PE) and Jayah et al. [41] conducted on rubber wood (RW). It is here remarked that the whole set of experiments was conducted with different moisture content (MC) and equivalent ratio (ER), for a total of 16 cases, in a downdraft gasifier. Table 2 and 3 summarize the biomass chemical composition and the gasifier operating conditions used to validate the model.

Table 2. Ultimate analysis of the biomasses obtained from [40, 41].

| Biomass | C (%) | H (%) | N (%) | O (%) | Ash (%) | LHV (MJ/kg) |
|---------|-------|-------|-------|-------|---------|-------------|
| PE | 50.7 | 6.9 | <0.3 | 42.4 | 0.39 | 18.86 |
| RW | 50.6 | 6.5 | 0.2 | 42 | 0.7 | 19.6 |

Table 3. Gasifier operative conditions of the experiments used for model validation [40,41].

| Biomass | MC (%) | ER |
|---------|---------------|-------------|
| PE | 6.38 ÷ 8.00 | 0.23 ÷ 0.27 |
| RW | 12.50 ÷ 18.50 | 0.30 ÷ 0.38 |

It is possible to evidence that the two biomasses have quite similar composition, whereas the MC content of the RW is about two times that the one of the PE. Moreover, the equivalence ratios (ER), defined by the actual air/biomass ratio divided by the stoichiometric air/biomass ratio, used in the RW experiments are higher than the ERs used in the PE experimentations as consequence of the higher MC content.

3.2. Results of the not calibrated model

The predicted data of the scrubbed model are almost not accurate especially for the gaseous species H₂ and CH₄; there was a great overestimation of the H₂ percentage, whereas the CH₄ percentage was substantially underestimated, about zero. Thereby, the calibration of the model was performed as in the follows described:

- It was foreseeing a relation between *ER* and *MC* [25,26]
- It was adopted, in the R-Gibbs reactor, the option “temperature approach”, both for the water-gas shift and the methanation reaction [29,43].

The correct choice of the ER is a crucial factor within the gasification process since low ERs reduce the reaction

temperature and, consequently, the yield of syngas is reduced. On the other hand, high ERs result in consumption of more H₂ and other combustible gases, through oxidization reactions, causing the decrease of the LHV of the producer gas. Gagliano et al. [25, 26] in their studies highlighted the biomass moisture content is one of the operating variables that can drive the choice of the most appropriate ER for modeling the gasification process. Therefore, they proposed a correlation (see eq. 4) between the biomass moisture content (*MC*) and the equivalent ratio (*ER*), which allows to mitigate one of the limits of the thermodynamic equilibrium models, that is the underestimation of CH₄ and the overestimation of H₂:

$$ER = 0.008 \cdot MC + 0.174 \quad (4)$$

Equation 4 states that ER increases with *MC*, in accordance with the gasifier energy balance equation, since the increase of air mass provides the required energy for the moisture vaporization and at the same time avoids the reactor temperature decrease. Thus, the model was calibrated using as input data, in the software Aspen, the ER value deriving by equation (4).

In addition, in the R-Gibbs reactor was set the option “temperature approach” for the two chemical reactions of gasification taken into account [44]. This option allows to specify, for the chemical reactions involved, an equilibrium temperature different from the one of the gasification reactor and, consequently, allows to move the reaction equilibrium versus reagents or products, with the consequent change of the composition of the gas at the outlet of the reactor. It is worth of notice that the temperature approach is defined as the difference between the temperature at which the chemical equilibrium is calculated and the actual reactor temperature. The values of the temperature approach, chosen during the model calibration, are -290 °C and -190 °C, respectively for the water-gas shift reaction and the methanation reaction.

4. Results of the calibrated model

In a gasification process, numerous variables, such as the composition of the biomass, particles size, moisture content, equivalent ratio, heating rate, temperature, reactor configuration and the use of catalysts affect the yield of hydrogen and, generally, the production of the other non condensable gases (NCGs). Between the variables above mentioned, the biomass moisture content *MC* and the equivalent ratio *ER* are two of the most important parameters that influence the chemical composition of the producer gas.

MC affects the efficiency of the gasification process, indeed it reduce the temperature process playing a key role in the products distribution. It is known that an high *MC* content is responsible for the reduction of H₂ and CO in the producer gas and for the increase of CO₂. As a consequence, the heating value of the syngas decreases while the *MC* increases. According to non – stoichiometric mathematical models for downdraft gasifiers, the increase in biomass *MC* of 40% results in the reduction of the LHV of the syngas by about 1 MJ/Nm³. Anyway, the *MC* acceptable depends on the typology of reactor, for example the updraft gasifiers can be fuelled with biomasses which have an higher moisture content.

The equivalent ratio *ER* has a key role in the efficiency of the gasifier process too. If an high *ER* is used, the N₂ content in the syngas increases and, consequently, the LHV decreases. At the same time, the increase of the *ER* allows the increase of the reactor temperature, promoting the volatilization process, the gaseous products yield and reducing the tar content in the syngas. Many studies show a strong correlation between *ER* and syngas chemical composition. The effect of *ER* on the CO₂ production strongly varies in different studies. According to many studies, CH₄ concentration, in the syngas, goes down with *ER* growing. CO and H₂ content decrease with very high *ER*.

For the above mentioned reasons, an accurate choice of the two parameters is essential for the optimization of the process. Due to the influence of *ER* and *MC* on the syngas chemical composition obtained, the proposed model was tested with different values of the two parameters. Anyway, except for some cases, the influence of the *ER* and *MC* on the chemical composition of the syngas resulted limited, due to the very small range of variation of the two parameters considered.

In the figures 3, 4, 5 and 6 the comparisons, between the simulated and experimental data (H₂, CO, CH₄ and LHV) versus the biomass moisture content (*MC*) are shown.

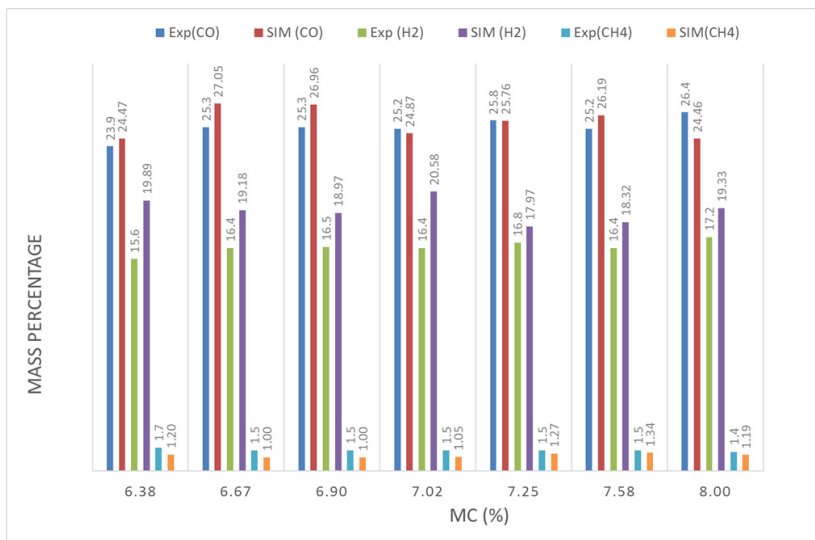

Fig. 3. Comparison between experimental and simulated syngas composition (Pellet).

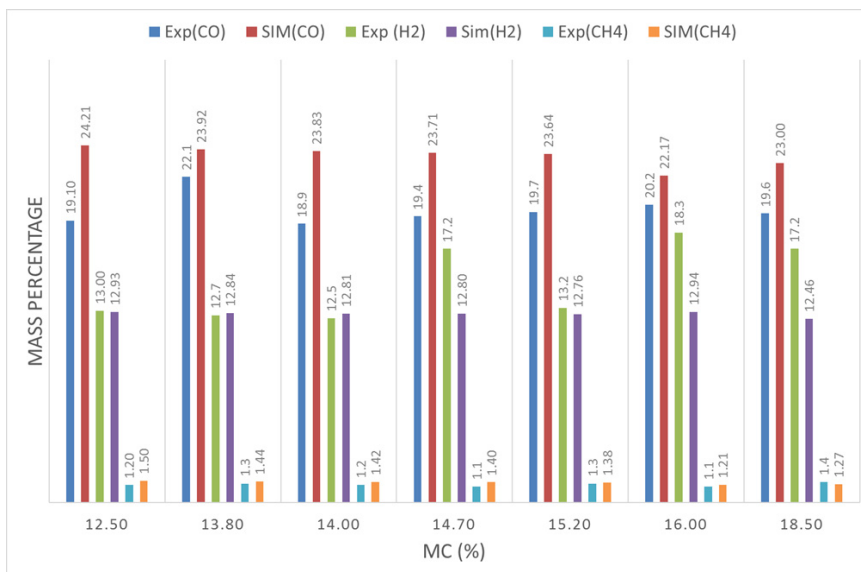

Fig. 4. Comparison between experimental and simulated syngas composition (Rubber Wood).

It is possible to observe that the results of simulations are quite similar with the experimental data. Anyway, it is possible to highlight some differences between the two set of data. As an example, the H₂ concentration is underrated in the experiments on Rubber Wood, especially when the MC content is higher, on the contrary the H₂ concentration is overrated in the experiments on Pellet. The CO prediction is quite coincident with the experimental results in the experiment on Pellet, whereas it is quite overestimated in the experiment on Rubber Wood. Really, acceptable differences can be noticed with reference to the prediction of CH₄ for the two biomasses.

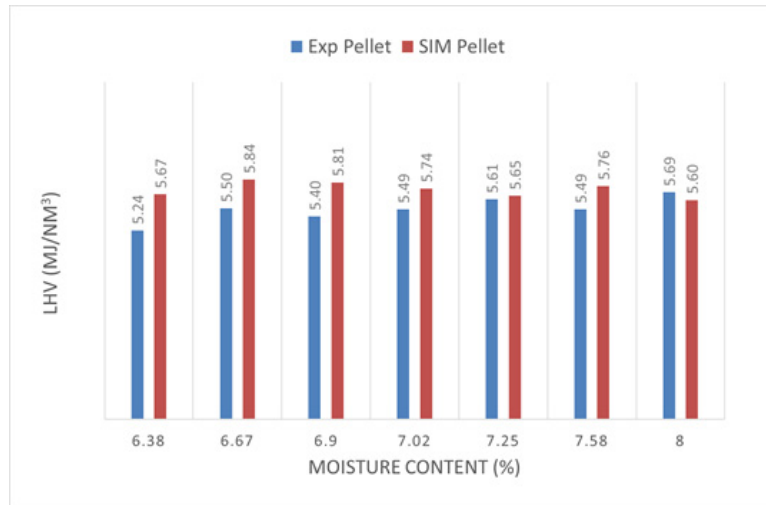

Fig. 5. Comparison between experimental and simulated data for LHV (Pellet).

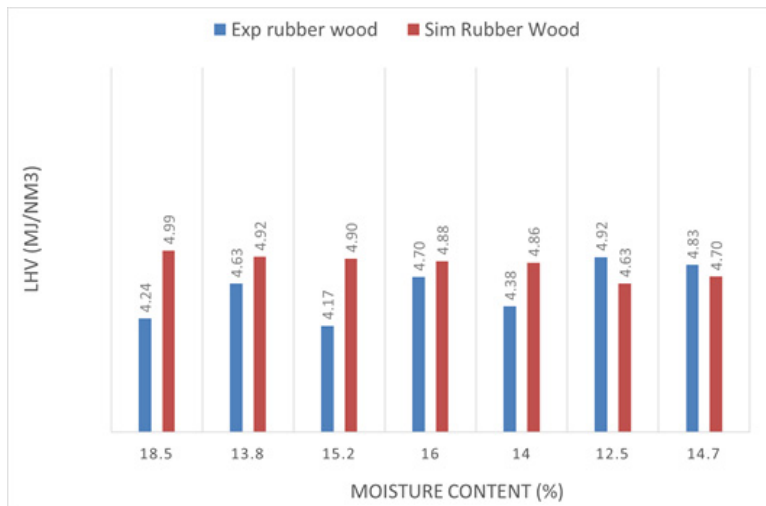

Fig. 6. Comparison between experimental and simulated data for LHV (Rubber Wood).

The LHV is generally overestimated due to the overestimation of the combustible gases H₂ and CO.

It is worth of note to remark that the temperature approach allows to considerably reduce the underrate of the CH₄, that initially was of about 90%.

Figures 7a and 7b show the comparison between the experimental and simulated data, considering a specific moisture content value for Pellet and Rubber Wood, that was respectively MC = 7.5% and MC = 13.8%. The model exhibits an overrate of the H₂ percentage and an underrate of the CH₄ percentage in the producer gas (especially for Pellet), that is a typical behavior of the thermodynamic equilibrium models. The underestimation of the CH₄ could be attributed to the fact that, in the real gasification processes, the producer gas does not achieve the complete equilibrium conditions inside the gasifier [26]. For this reason, to prevent the complete consumption of methane, in

some literature models a correction coefficient to move the methanation reaction to the CH₄ production (avoiding its consumption) is introduced, whereas other studies do not include a fraction of CH₄, formed during the pyrolysis process, in the combustion-gasification stage bypassing it to the gasifier outlet [45, 46].

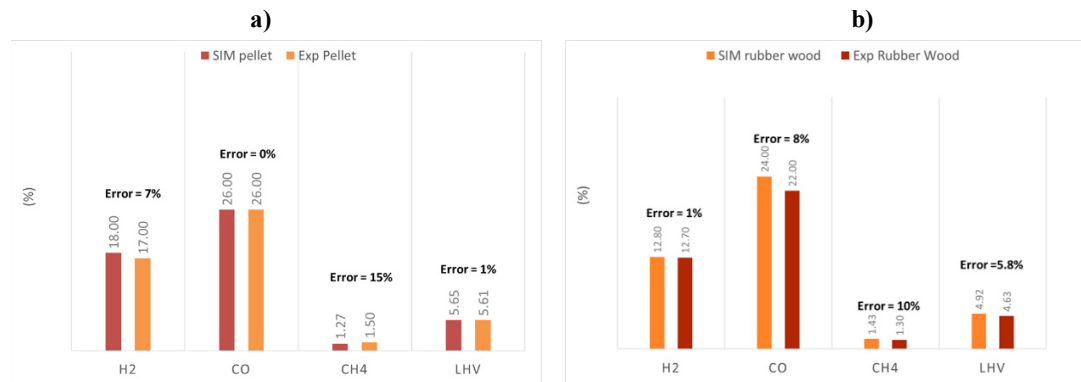

Fig. 7. Comparison between experimental and simulated data: a) Pellet; b) Rubber Wood.

Globally, the average percentage error, E_a , calculated for the sixteen simulated cases, is 15.0% on H₂, 11.0% on CO, 19.0% on CH₄ and 6.5% on LHV. The quite satisfactory prediction of H₂, CO and LHV is certainly attributable with the choice to take in account both char and tar production in the balance equations.

5. Conclusions

This study proposes a thermodynamic equilibrium model, developed by Aspen Plus, able to simulate the biomass gasification process in a downdraft gasifier. The model, which takes into account char and tar formation, is based on the chemical reactions of water-gas shift and methanation and on the setting of the “temperature approach” for these ones. Model validation was carried out through the comparison with experimental data, concerning two biomasses with different moisture content and different gasification conditions, for a total of sixteen cases compared.

A good agreement between the experimental data and the percentages of the combustible gases (H₂, CH₄, CO), predicted by the model, was found. The average error was of 15% with reference to the combustible gases in the syngas and lower than 7% on the predictions of the LHV. Globally, it is possible to affirm that the validated model is reliable for the prediction of syngas chemical composition and heating value, varying MC and ER .

References

- [1] Bauen A, Berndes G, Junginger M, Londo M, Vuille F, Ball R. Bioenergy - a sustainable and reliable energy source. IEA Bioenergy 2009; 06:108.
- [2] Faaij APC. Bio-energy in Europe: changing technology choices. Energy Policy 2006; 34:322-42.
- [3] Zainal ZA, Ali R, Lean CH, Seetharamu KN. Prediction of performance of a downdraft gasifier using equilibrium modeling for different biomass materials. Energy Convers Manag. 2001; 42:1499-1515.
- [4] Giltrap DL, McKibbin R, Barnes GRG. A steady state model of gas-char reactions in a downdraft biomass gasifier. Solar Energy 2003; 74: 85-91.
- [5] Jahirul MI, Rasul MG, Chowdhury AA, Ashwath N. Biofuels Production through Biomass Pyrolysis—A Technological Review. Energies 2012; 5: 4952-5001.
- [6] Sotudeh-Gharebaagh R, Legros R, Chaouki J, Paris J. Simulation of circulating fluidized bed reactors using ASPEN PLUS. Fuel 1998; 77(4):327-37.
- [7] Visconti MD. An Aspen Plus tool for simulation of lignocellulosic biomass pyrolysis via equilibrium and ranking of the main process variable. International journal of mathematical models and methods in applied sciences 2015; 9:71-86.
- [8] Kundsén RA, Bailey T, Fabiano LA. Experience with ASPEN while simulating a new methanol plant. AIChE Symposium Series 1982; 78-214.

- [9] Begum S, Rasul MG, Akbar D. A Numerical investigation of municipal solid waste gasification using Aspen plus. *Procedia Engineering* 2014; 90:710 – 7.
- [10] Idowu A, Isam J. Modeling of the entrained flow gasification: Kinetics-based ASPEN Plus model. *Renewable Energy* 2014; 1-8.
- [11] Mansaray KG, Al-Taweel AM, Ghaly AE, Hamdullahpur F, Ugursal VI. Mathematical modeling of a fluidized bed rice husk gasifier. *Energy Sources* 2000; 22: 83–98.
- [12] Mathieu P, Dubuisson R. Performance analysis of a biomass gasifier. *Energy Convers Manage* 2002; 43:1291–9.
- [13] Nikoo MB, Mahinpey N. Simulation of biomass gasification in fluidized bed reactor using ASPEN PLUS. *Biomass Bioenergy* 2008; 32: 1245-54.
- [14] Doherty W, Reynolds A, Kennedy D. Simulation of a circulating fluidized bed biomass gasifier using ASPEN Plus—a performance analysis. In: Ziebik A, Kolenda Z, Stanek W, editors. *Proceedings of the 21st international conference on efficiency, cost, optimization, simulation and environmental impact of energy systems*. Krakow, Poland; 2008. p.1241-1248.
- [15] Doherty W, Reynolds A, Kennedy D. The effect of air preheating in a biomass CFB gasifier using Aspen Plus simulation. *Biomass Bioenergy* 2009; 33:1158–67.
- [16] Aspen plus user guide http://profsite.um.ac.ir/~fanaci/_private/APLUS%20111%20Getting%20Started%20Solids.pdf.
- [17] Peng, D, Robinson, DB. A New Two-Constant Equation of State, *Ind. Eng. Chem. Fundam.* (1976); 15, 59-64
- [18] Michailos S, Zabaniotou A. Simulation of Olive Kernel Gasification in a Bubbling Fluidized Bed Pilot Scale Reactor. *Journal of Sustainable Bioenergy Systems* 2012; 2:145-59.
- [19] Ward J, Rasul MG, Bhuiya MMK. Energy recovery from biomass by fast pyrolysis. *Procedia Engineering* 2014; 90: 669 –74.
- [20] Kabir MJ, Chowdhury AA, Rasul MG. Pyrolysis of Municipal green waste: A modeling, simulation and experimental analysis. *Energies* 2015; 8:7522-41.
- [21] Atnaw SM, Sulaiman SA, Yusup S. A simulation study of downdraft gasification. *Journal of applied science* 2011; 11:1913-20.
- [22] Sotudeh-Gharebaagh R, Legros R, Chaouki J, Paris J. Simulation of circulating fluidized bed reactors using ASPEN PLUS. *Fuel* 1998; 77(4):327–37.
- [23] Sidoti M. Produzione di energia elettrica da pirolisi e gassificazione di biomassa. Thesis of Master Degree in Energetic Engineering. Milan Polytechnic 2013.
- [24] Ergudenler A, Ghaly AE. Mathematical Modeling of a Fluidized Bed Straw Gasifier: Part I—Model Development. *Energy Source* 1997; 19(10): 1065-84.,
- [25] Gagliano A, Nocera F, Patania F, Detommaso M, Bruno M. Evaluation of the performance of a small biomass gasifier and micro-CHP plant for agro-industrial firms. *International Journal of Heat and Technology* 2015; 33 (4) 145-154.
- [26] Gagliano A, Nocera F, Patania F, Bruno M, Castaldo D. A robust numerical model for characterizing the syngas composition in a downdraft gasification process. *C R Chimie* 2016; 19: 441–9.
- [27] Barman NS, Ghosh S, De S. Gasification of biomass in a fixed bed downdraft gasifier – A realistic model including tar. *Bioresource Technol* 2012; 107:505-11.
- [28] Anukam A, Mamphweli S, Meyer E, Ombola O. Computer Simulation of the Mass and Energy Balance during Gasification of Sugarcane Bagasse. *J of Energy* 2014; 2014:9.
- [29] Yamazaki T, Kozu H, Yamagata S, Murao N, Ohta S, Shiya S, Ohba T. Effect of superficial velocity on tar from downdraft gasification of biomass. *Energy Fuels* 2005; 19: 1186-91.
- [30] Xiao G, Jin BS, Zhong ZP, Chi Y, Ni M, Cen K, Xiao R, Huang Y, J. of Environm Sciences 19 (2007).
- [31] Gungor A. Modeling the effects of the operational parameters on H₂ composition in a biomass fluidized bed gasifier. *Int J Hydrogen Energy* 2011; 36:6592-600.
- [32] Bridgwater AV. Overcoming Barriers to Bioenergy: Outcomes of the Bioenergy Network of Excellence 2003 – 2009. *Biomass and Bioenergy* 2012; 38: 1-144.
- [33] Sharma AK. Equilibrium modeling of global reduction reactions for a downdraft (biomass) gasifier. *Energy Convers and Manag* 2008; 49:832-42.
- [34] Thunman H, Niklasson F, Johnsson F, Leckner B. Composition of volatile gases and thermochemical properties of wood for modeling of fixed or fluidized beds. *Energy and Fuels* 2001; 15: 1488-97.
- [35] Adams TN. A simple fuel bed model for predicting particulate emissions from a wood-waste boiler. *Combustion and Flame* 1980; 39(3):225-39.
- [36] Ragland K, Aerts DJ, Baker AJ. Properties of wood for combustion analysis. *Biosource Technol* 1991; 37:161-8.
- [37] Tinaut FV, Melgar A, Perez JF, Horrillo A. Effect of biomass particle size and air superficial velocity on the gasification process in a downdraft fixed bed gasifier. An experimental and modelling study. *Fuel Process Technol* 2008; 89:1076-89.
- [38] Grønli MA. Theoretical and Experimental Study of the Thermal Degradation of Biomass. Academic Dissertation, The Norwegian University of Science and Technology, Trondheim, 1996; ISBN 82-471-0009-6.
- [39] Di Blasi C. Dynamic behaviour of stratified downdraft gasifiers. *Chem Eng Sci* 2000; 55:2931-44.
- [40] Barrio M, Fossum M, Hustad JE. A small-scale stratified downdraft gasifier coupled to a gas engine for combined heat and power production. *Technologies and Combustion for a Clean Environment*. Sixth International Conference 2001.
- [41] Jayah TH, Aye L, Fuller RJ, Stewart DF. Computer simulation of a downdraft wood gasifier for tea drying. *Biomass Bioenergy* 2003; 25:459-69.
- [42] Oliveira A. Downdraft gasification of biomass. Experimental simulation and Aspen Plus simulation.
- [43] Xie J, Zhong W, Jin B, Shao Y, Liu H. Simulation on gasification of forestry residues in fluidized beds by Eulerian-Lagrangian approach. *Bioresour Technol* 2012; 121:36-46.
- [44] Doherty W, Reynolds A, Kennedy D. Aspen Plus Simulation of Biomass Gasification in a Steam Blown Dual Fluidised Bed. In: Méndez-Vilas A ed. Chapter: Materials and processes for energy: communicating current research and technological developments Conference paper. Dublin Institute of Technology. Formatex Research Centre; 2013.
- [45] Vera D, Jurado F, Panopoulos KD, Grammelis P. Modelling of biomass gasifier and microturbine for the olive oil industry. *Int J Energy Res* 2012; 36(3): 355-67.
- [46] Cordiner S, Feola M, Mulone V, Romanelli F, Analysis of a SOFC energy generation system fuelled with biomass reformat. *Appl Therm Eng* 2007; 27: 738-47.