

Model-Based Design of Complex Aeronautical Systems Through Digital Twin and Thread Concepts

Original

Model-Based Design of Complex Aeronautical Systems Through Digital Twin and Thread Concepts / Bachelor, G., Brusa, E., Ferretto, D., Mitschke, A.. - In: IEEE SYSTEMS JOURNAL. - ISSN 1932-8184. - 14:2(2020), pp. 1568-1579. [10.1109/JSYST.2019.2925627]

Availability:

This version is available at: 11583/2785392 since: 2020-06-04T11:55:25Z

Publisher:

IEEE

Published

DOI:10.1109/JSYST.2019.2925627

Terms of use:

This article is made available under terms and conditions as specified in the corresponding bibliographic description in the repository

Publisher copyright

IEEE postprint/Author's Accepted Manuscript

©2020 IEEE. Personal use of this material is permitted. Permission from IEEE must be obtained for all other uses, in any current or future media, including reprinting/republishing this material for advertising or promotional purposes, creating new collecting works, for resale or lists, or reuse of any copyrighted component of this work in other works.

(Article begins on next page)

Model Based Design of complex aeronautical systems through Digital Twin and Thread concepts

G. Bachelor, E. Brusa, D. Ferretto, A. Mitschke

Abstract— Managing the lifecycle of the elements of a complex and safety-critical system, from conceptual design to support in operation, is still a relevant challenge in the industrial domain. Starting from research and engineering activities, up to production and delivery, the need of maintaining trace of dependency, changes and possible updates regarding the final product is a crucial aspect for success. Particularly, conceptual and preliminary design activities are affected by a high level of uncertainty and a certain degree of project instability, usually caused by the need to explore alternative solutions and variants. Different tasks are performed concerning the identification of system requirements, functional and physical behavior using Model Based Design (MBD) and Model Based Systems Engineering (MBSE), which, generally, are subjected to extensive trade studies aimed at identifying the best solution. In this context, this work presents how model based Digital Twin and Threads concepts will likely change the way in which the model based design process is managed, overcoming the issues associated with federated IT infrastructures and with tools integration. Notably, lifecycle and non-lifecycle related interoperability aspects are described, with particular focus on the exploitation of standards for lifecycle collaboration and heterogeneous simulation. The design of an ice protection system for a regional aircraft is selected as case study, starting from the work performed by the authors within the EC funded research project CRYSTAL.

Index Terms— Model-Based Design, Digital Twin, Digital Thread, Ice Protection System, Aircraft on-board system

The research leading to these results has received funding from the ARTEMIS Joint Undertaking under Grant Agreement N° 332830 and from specific national programs and / or funding authorities.

The authors wish to thank Lev Greenberg of IBM Research for the precious contribution in setting and refining up the simulation concept. The authors make no claim over the applicability of the illustrative aeronautical system described here for any real world safety critical operations.

G. Bachelor is with *IBM Watson IoT Development, IBM United Kingdom Ltd.*, PO Box 31, Birmingham Rd Warwick, CV34 5JL, UK gray_bachelor@uk.ibm.com

E. Brusa is from *Department of Mechanical and Aerospace Engineering (DIMEAS) Politecnico di Torino*, Corso Duca degli Abruzzi 24, 10129, Turin, Italy eugenio.brusa@polito.it

D. Ferretto is from *Department of Mechanical and Aerospace Engineering (DIMEAS) Politecnico di Torino*, Corso Duca degli Abruzzi 24, 10129, Turin, Italy davide.ferretto@polito.it

A. Mitschke is with *Airbus Central R&T - Virtual Product Engineering, Airbus Defence and Space GmbH*, Hein-Sass Weg 22 21129 Hamburg, Germany andreas.a.mitschke@airbus.com

I. INTRODUCTION

THE concepts of Digital Twin and Digital Thread promise to disrupt the way complex systems are designed, manufactured, and operated. While exact definitions for these terms vary, the principal idea is to provide a virtual representation (Digital Twin) of the key elements and the dynamics of a system in the needed lifecycle process or operational context, from initial design to manufacture and operation. The Digital Threads are then the relationships amongst these representations or with their sources. Among other new possibilities, this will allow easier prediction of the impact that changes to a system design solution has to its production and operation. This also helps finding the optimal system design alternative against multiple viewpoints, including operational performance and manufacturability. Realizing the concept of Digital Twin and Digital Thread requires addressing various challenges, especially with regard to the fact that, in most cases, such a concept cannot be built from scratch, but has to be deployed within an existing IT landscape that typically consists of multiple specialized software tools and various different databases.

Within the EC funded Artemis CRYSTAL project the parties reporting here collaborated directly in multiple waves to address assembly and operation of Digital Twins for system function, physical effects, operating environment and mission, with Digital Threads of relevance and relationship to specifications, configurations and supporting activities like engineering. Furthermore they prototyped and built up analytical techniques to enable progress and raise problems to guide work towards targets. The reporting parties, along with other CRYSTAL partners, focused especially upon achieving Digital Twins and Threads from real world combinations of proprietary and open source tools, using open industry standards for technical information representation and interoperability.

In this paper, certain results from the CRYSTAL research project that addresses some of the challenges of implementing such Digital Twin and Thread concepts in a heterogeneous IT landscape are presented by considering a typical aerospace Original Equipment Manufacturer (OEM). Particularly, a key topic explored here is how to make the Twins and Threads open, accessible and extensible, to accelerate the normal evolution that occurs in their use and to promote wider re-use. Notably, Section II of this paper presents the state of the art for Digital Twin and Thread concepts, with focus on the positioning of this work in the Model Based Systems

Engineering (MBSE) landscape. Section III introduces the approach and describes the systems engineering challenges related to the selected case study from aerospace domain. Section IV depicts the implementation scenario, concerning the Digital Twin representations of the system through dynamic models in the presence of changes. Section V briefly discuss the results coming from the application of Digital Twins and Threads to directed simulation campaigns, with special focus on the impact of changes concerning the system under design. Section VI provides an evidence of how the use of such Digital Twin and Thread models and modelling techniques becomes of vital importance to deal with the complexity and rate of changes, considering their influence on visibility and traceability of data over the product lifecycle and drawing conclusions. Finally Section VI summarizes main future works for this topic.

II. STATE OF THE ART

A. Digital Twin and Thread definition

Digital Twin and Thread are aspects of Digitalization which companies and organizations pursue as part of transformation of business, technical and industrial processes, products and services, such as related to Industry 4.0.

For Aerospace this means all aspects of complex products, operations, market or customer engagement, concept evolution, engineering, manufacturing and in-service operations. This may include also the analysis of market trends and customer needs, scouting for technologies, product definition and system engineering through to optimization of manufacturing and operations. Using end to end traceability, or Digital Continuity, to aid multi-disciplinary decision making such over trade studies, change impact analysis, defect analysis and problem solving, are examples of focused application of Digital Threads. Greater digitalization also enables increased use of Digital Twin for simulation and analysis to optimize, evaluate alternatives, eliminate defects and avoid the need for physical mockups and prototypes construction.

A Digital Twin is often quoted as virtual (Digital) representation (set of information) of a physical item or object, or intended physical item [1]. A key aspect of a Digital Twin is to support some purposes using an aggregation, abstraction or analysis, or some combination, of available information, which may include a projection or prediction of some future states. In this example we are dealing with Digital Twin representation of a future state of an intended item, i.e. requirements, designs etc.

In this work the following perspective of Digital Twins were built up:

- Aggregated views - such as of information state and history of information state for Engineering process (Activities, Organizations, Roles, Goals, measures), System and Product models and Configurations;
- Abstracted models - such as functional and physical models of systems and their operating environment;

- Analytical results and views - such as the status of Requirements, Designs, Activities, Model assessments, including targets and trade studies or analysis of sensors or information, gathered from operational product.

Digital Thread or Digital Continuity can be considered as a perspective of relationships through different representations making up a Digital Twin, or between Twins, aimed at showing:

- Change in ownership or contribution;
- Evolution of information along the lifecycle by way of key representations, e.g. vision, concepts, requirements, design models, prototypes, implementations, usage views etc...
- History of changing configurations of contributions and responsibilities;
- Specific information transformations, e.g. from a functional state model to a time domain continuous variable model or from a physical design model to a manufacturing specification with measurable dimensions and tolerances;
- A physical flow or record of information location, usage and access.

B. Positioning of the work within state of the art landscape

The authors note that academic research and industry definition of Digital Twin are evolving. However useful surveys of Digital Twin research are available in literature [2] According to the classification therein, and based upon an extensive literature analysis, the work described in this paper can be characterized as in Table 1 from the point of view of use and scope, as suggested in [2].

Table 1. State of the art positioning of this article

Field	Aerospace Engineering
Use	Aerospace Systems simulation
Type of analysis	Power consumption determination Ice removal efficiency prediction Time Response analysis
Simulation	Numerical simulation Simulations at system level during design
Simulation Software	IBM Rhapsody® DS Simulia Dymola® MathWorks Simulink® OpenModelica

III. APPROACH

A. The CRYSTAL Project

Addressing the challenge of providing efficient tools integration was one of the main aspects of the Artemis JU funded Research Project CRYSTAL (CRITICAL SYSTEM

engineering AcceLeration) [3]. The CRYSTAL project ran from May 2013 to April 2016 and involved 68 Partners from 10 European Countries. Leading European transportation and health care companies as well as major tool vendors and academic partners joined CRYSTAL to define a Standard for tool interoperability, and, based on this, to then define new methods for improved specification, design, and analysis and lifecycle management of safety-critical complex systems. The project was assessed by the EC to have succeeded at its final review in September 2016.

A great success of the last 30 years has been the development of a rich and varied set of tools to address many aspects of technology application in industrial products, which have provided productivity and assurance gains as the scale or complexity of that application has grown. However there has been a flip side of that specialization, which has its own problems: tool and platform incompatibility. Fig. 1 illustrates this challenge: today, the situation of many industrial companies is characterized by a fragmented IT landscape with many specialized tools and data-bases that are poorly connected. Managing this infrastructure is expensive. More important, it has a negative impact on the industrial workflows, since significant manual effort is required to assemble a flow and to update it according to technology, tools or organizational changes [4]. One of the most common solutions to face this problem in the industrial field consists of developing dedicated connectors and/or adapters to allow communications among different software. This solution may be required in specific cases where alternatives are not available but, even if supported by use of standard semantics [5], is not the most effective, because replicability and adaptability is generally a major concern. The aim of CRYSTAL was to change this situation by enhancing the “tool layer” such that the data of each tool is exposed in a standard way. This should allow other tools to access this data and eventually link to it, enabling new open Digital Twins and Threads to be made available. On top of this it would be possible to define new re-usable methods to better support the industrial workflows. The envisaged standard for tool interoperability shall be based on existing standards when possible.

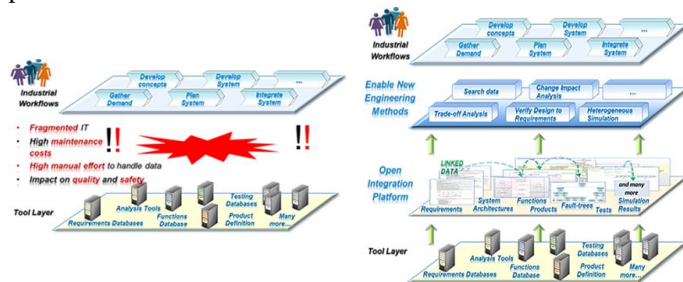

Fig. 1. The CRYSTAL approach [3]

B. Systems Engineering capability segmentation

In general, any initiative around Engineering process improvement faces the challenge of analyzing and representing multiple specialized domains (for example between specific technological or physical/mathematical

representations) and many business or technical abstractions. To overcome this fundamental challenge in such a cross-industry project, and to also avoid the temptation to try to propose a grand cross-industry ontology, a more empirical, segmentation of Systems Engineering capability was made within the CRYSTAL project, reflecting as follows:

1) Lifecycle processes

Lifecycle processes are cross-cutting processes that span phases (e.g. research, development, manufacturing, support), disciplines (different technical and non-technical) and organizations. An important aim of IT support for lifecycle processes is to achieve information representations which promote collaboration, without the need for very tight coupling e.g. to support activities such as reporting, coordination, planning, change and configuration management. Open Services for Lifecycle Collaboration (OSLC) [6] supports lifecycle collaboration by providing common service definitions for communicating summarized or abstracted information, such as a Change Request, with the open world assumption that additional specialized information can be added. In addition, it provides a set of common technical protocols for service providers and consumers, enabling support for daily working methods and lightly couple automation to be built up (e.g. service discovery, query, delegated user interface, resource creation factory, change logs). The availability and evolution of OSLC services for distributed configuration management, which was also applied as part of this work, is of great interest in the engineering and scientific community.

2) Non-lifecycle processes

Non-lifecycle are the discipline or technology specific processes which are more focused and detailed with the evolution of a product or system along its lifecycle. An important aim of IT support for non-lifecycle processes is to achieve information representations which enable detailed resolution of technical or physical questions or concepts (e.g. to support activities such as heterogeneous co-simulation of system behavior, combination of dynamic testing and formal static analysis, variability management, design space exploration). Functional Mock-up Interface (FMI) [7] supports non-lifecycle collaboration because it supports deep and detailed specification of logical and physical model interactions, including synchronization of model events and model variable status between different simulators in a time critical manner.

In this work System Modeling Language (SysML) [8] fulfils particular aspects of lifecycle collaboration, by providing traceability of the allocation of requirements to system function definitions, and then through OSLC for traceability to requirements, change request and tests. On the other hand, SysML also provided the formality to allow state machine definition and model execution to validate system logical behavior and support transformation of model structure into a form suitable for FMI integration. This enables Digital Threads for traceability across the abstracted lifecycle and more detailed non-lifecycle Digital Twin representations.

3) Standards selection in CRYSTAL

Following this basic segmentation, the CRYSTAL consortium [3] has selected the emerging OSLC standard as a basis for covering lifecycle interoperability. A promising candidate standard for non-lifecycle related interoperability is, among others, the FMI standard.

In summary, the primary enabling technologies applied to assemble open -Digital Twins and Threads in this work were:

- Integration of more traversal, lifecycle concerns using linked data concepts using OSLC applied via HTTP/HTTPS/RDF/SPARQL/JSON;
- Integration of deeper inter-domain functional and physical system concepts using FMI (making benefit of XML).

The study, described Section IV, relies mainly on the use of the FMI standard to support heterogeneous simulation scenarios. The overall Linked data concepts are currently in an implementation phase and therefore some views on the possible outlook and outcomes are presented in Section VII.

C. Systems Engineering challenge: public aerospace use case

Each industrial partner of CRYSTAL defined an individual use case. In addition, aerospace partners defined a common and artificial Public Aerospace Use Case. The objective of this Public Aerospace Use Case was to describe typical aerospace engineering challenges with respect to inter-discipline tool interoperability, to perform a prototyping of CRYSTAL concepts, and to facilitate the presentation of CRYSTAL results in publications without facing IPR concerns. For the Public Aerospace Use Case the design, analysis and specification of an Ice Protection System for a regional turboprop aircraft was chosen as application example (Fig. 2). The purpose of this system is to prevent and/or reduce the creation of ice on safety critical components of the aircraft, such as sensors, wings, engines, or ogives.

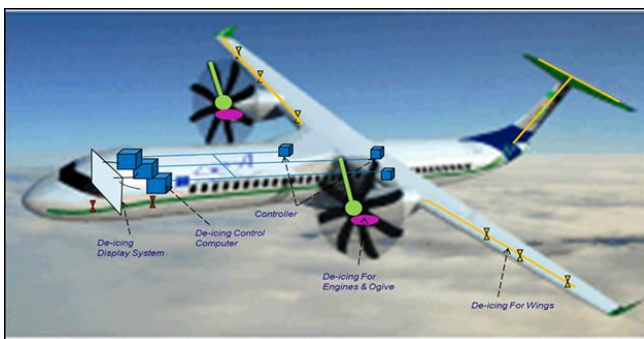

Fig. 2. Public aerospace use case example – Ice Protection System

Accumulation of ice on wings, nacelles, tail and instruments is one of the most dangerous risks for the aircraft flight at different altitudes. Ice accretion is a very heterogeneous phenomenon as it depends on several environmental parameters as well as upon some properties of the aircraft. Very often ice is a consequence of a concentration of super-cooled water within clouds, characterized by being

liquid even below 0 °C. Water droplets hit the aircraft and freeze very fast or instantly, thus causing a reduction of lift and of the angle of attack which might be considered a limit for the stall. They increase drag and weight, by causing some adverse effects on control surfaces and induce a flow disruption. Therefore several anti-icing systems are used to avoid the ice accumulation or, alternately, some de-icing systems are applied to reduce the ice accretion.

Among the technologies implemented, some very well-known are the pneumatic de-icing systems, designed to apply a suitable action to break the ice layers by means of pneumatic boots that cover the most exposed aerodynamic surfaces on the leading edges, and the electro-thermal system based on the heat produced by resistors, used either as an anti-icing or de-icing system. These solutions, in fact, have been selected respectively as common version of a real de-icing system, actually adopted on the majority of commercial turboprop aircrafts, and an innovative one (not in terms of technology but for its use on the whole aircraft) according to the More Electric Aircraft (MEA) design trend. The behavior of the two systems will be assessed through simulation in terms of some Key Performance Indicators (KPI) like power consumption and ice melting rate. The proposed icing environments have been extracted from the current Certification Specification CS-25 [9] including statements about typical supercooled droplets environment (Appendix C) but also about supercooled large droplets environments (Appendix O), recently issued by the European Aviation Safety Agency (EASA) for further extensions of the certification process for large aircrafts.

IV. DIGITAL TWIN AND THREAD ARCHITECTURE AND SIMULATION ENVIRONMENT

A. Introduction

Within the project, the authors primarily focused upon the identification of suitable Digital Twins for the case study and upon the relationships among them, specified by the Digital Threads. Particularly, Digital Twins for system requirements, specification, functions, physical operations and physical performance have been defined. These were formed to represent aspects of atmospheric moisture and ice formation, de-icing system functionality, analysis of de-icing system safe operation and simulation to verify operation [10] and performance. The Digital Threads can be then found in the main measures of effectiveness for each Digital Twin assessed individually or in context as a group of measures, including their relationship to project tasks, specifications and prevailing configuration information.

The main activities performed within the Public Aerospace Use Case to pursue this strategy can be summarized as follows:

- Exploitation of industry standards for MBD and MBSE and Digital Twin and Threads
- Evolution of Digital Twins and certain Threads to increase model fidelity and optimize the organization of simulation model components

- Assembling alternative Digital Twins and Threads to assess trade-off towards system and business targets
- Driving unexpected change across the Digital Twins and Threads to identify dependency, impacted items, change strategies and scoping of work

Simulation plays a fundamental role in the preliminary phases of a design process, especially when considering complex and safety-critical systems as those from aerospace domain. As anticipated in Section III, the typical approach today uses specific tools and environments to implement models able to represent system behavior. In this case, the system is modelled thanks to the formal representation of the mathematical equations that rule its internal transitions, triggered with different inputs, which replace the variables of the environment, in order to test the dynamic response under typical operating conditions. However, the exploitation of proprietary environments organized upon stand-alone and segregated collection of data is inefficient when aiming at aligning system representations over an entire lifecycle. In fact, the only way of sharing information about model-based engineering tasks during the project is relying upon a highly connected tool chain able to integrate data at various technical levels in a flexible manner (e.g. to exploit hybrid simulations and to abstract at a product management level as well).

This is a typical challenge of complex engineering today and it is in line with the concepts of Digital Twin and Thread. In fact, the aim of this approach is to provide better overall visibility of activities, data and results, but also to expose some aspects of the control needed to operate or manage the domain tools, being able to drive simulation efficiently to the intended business or technical target. Particularly, heterogeneous simulation provides an explorative scenario, both in terms of the fidelity of the simulation of real world effects and in terms of the exploration of alternatives within trade studies.

The following sections will present the proposed approach to face this challenge, aimed at reaching an effective interoperability level based on the standardized process described in Section III.

It shall be highlighted that heterogeneous simulation approach is made up pursuing two main objectives. The first objective is aimed at allowing the different engineering disciplines to use the tool that they typically adopt, due to some favored abstraction, and in which they are more confident. In this way it is also possible to realize a typical commercial scenario in which several companies provide their own models as FMUs, coming from proprietary sources with their own semantics.

The second objective is allowing a degree of flexibility and re-use. The final simulation can be used to compare the proposed de-icing solutions in different operating conditions and icing environments, so it shall be possible to arrange the connections among the models to meet the configuration that the designer wants to test

The final heterogeneous model can be ideally divided in two areas: the model of the environment and of the ice

accretion dynamics connected to the flight mission profile of the aircraft, and the model that describes the behavior of the de-icing system. The tools that have been used to develop the different parts are IBM Rational Rhapsody® for system design and state-based behavior along with set-up of the simulation concept, Simulink® and Dassault Systemes Dymola® for the implementation of atmospheric model, aircraft systems operations and for final simulation. OpenModelica was also used for simple physical blocks and subsystems.

B. Change scenario: new regulations

The need to have a reusable and easy-replaceable structure of the simulation using a Digital Twin is mainly driven by the idea of supporting a typical industry regulation compliance assessment on different de-icing systems. Until 2014, the Regulation from the EASA specified the characteristics of the typical atmospheric conditions in which ice creation may affect aircraft flight within the Appendix C of the CS-25 (for large aeroplanes) [9]. This document provides the information about typical trends of the Liquid Water Content (LWC) and the Mean Volume Diameter (MVD) of the supercooled droplets floating in stratiform and convective clouds, defining the so-called continuous maximum and intermittent maximum profiles. These trends have been derived by National Advisory Committee for Aeronautics (NACA) from 1949 to 1952 and published within the regulatory framework of Federal Aviation Administration starting from 1965. Since 2003 they have been embedded in CS-25 as reference to predict the amount and the criticality of ice accretion phenomenon, providing a common base for de-icing systems sizing. Typical values are shown in Fig. 3 where a MVD of 20 μm is usually taken into account for calculations, being the most encountered during flights.

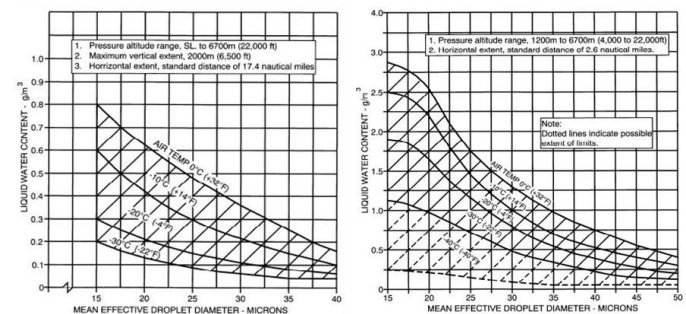

Fig. 3. LWC profiles from CS-25 Appendix C [9]

However, the current regulation has been enriched with some considerations on extreme atmospheric phenomena like the Supercooled Large Droplets (SLD) condition that is more critical in terms of ice accretion rate and that has been assessed as being responsible for several catastrophic accidents in the past years. These rare icing environments are characterized by a higher water catch efficiency of the aircraft aerodynamic appendices due to the presence of higher MVD of droplets (generally from 50 μm to 1000 μm) compared to the standard icing conditions (limited to 50 μm). They represent also a more complex phenomenon since the ice accretion is the result of the combination of multiple factors

This block can be easily adapted to simulate many different mission scenarios. The atmosphere model is described by the low level IBD shown in Fig. 7. The provided data are related to temperature, density and viscosity of the air (green and red blocks on the left), as specified by International Standard Atmosphere (ISA), together with the selected LWC profile prescribed by regulations, as function of altitude. As described in Section III B, two LWC profiles may be considered: the typical LWC specification included in Appendix C and the new proposed envelopes described in Appendix O. The LWC model from Dymola® (bottom right) is based on the former regulation and it considers the typical continuous maximum and intermittent maximum icing conditions for a Mean Volume Diameter (MVD) of the droplets of $20 \mu\text{m}$ (Fig. 4).

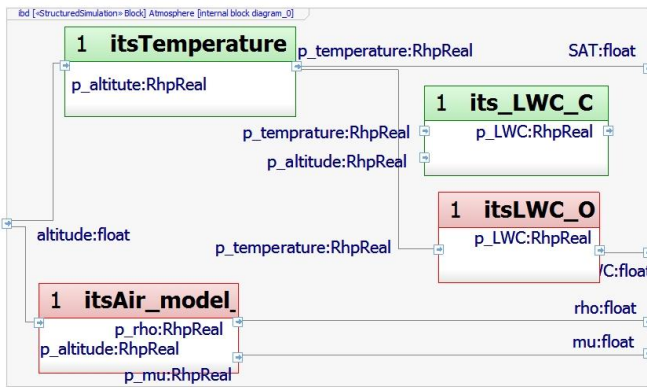

Fig. 7. Atmospheric Twin model IBD

The LWC profile included in the Simulink® block (top right in Fig. 7) is instead based on the freezing drizzle SLD conditions (MVD up to $500 \mu\text{m}$). The heterogeneous model, as for the flight mission profile, is thus able to support different icing environments as long as they provide the value of LWC as a function of altitude and temperature (or only as a function of one of them if they are related through ISA charts).

The computation of the ice accretion rate is instantiated in a separated area of the model that receives the atmosphere parameters (density and viscosity), the LWC and the aircraft speed. An example of IBD for ice accretion dynamics computation is shown in Fig. 8 together with the original Simulink® model used to implement the ice accretion on the wing.

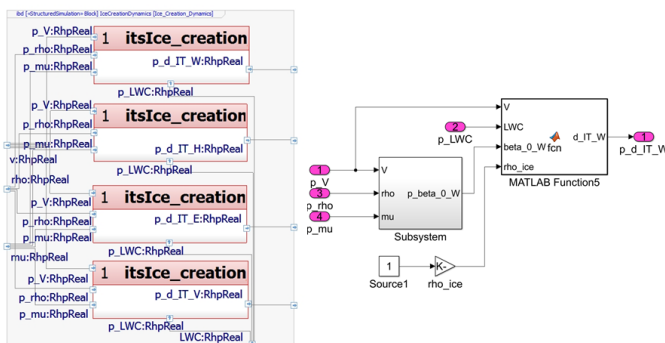

Fig. 8. Ice accretion dynamics IBD and Simulink® model for wing

Simple methods for the evaluation of the water catch efficiency applied to Appendix C icing conditions and ice accretion can be easily found in standards and literature [12, 13]. However, in order to support different kinds of icing scenarios it is necessary to apply an environment-independent ice accretion model. The model from Langmuir and Blodgett [14] based on the definition of a modified inertia parameter for the drop trajectory similarity was used to evaluate water catch efficiency. This approach is based on the application of the drop momentum equation that describes the motion of the drop exposed to an airstream and it is able to take into account the effect of its inertia. A light drop is more affected from deviation due to alignment with air path lines whereas a heavy drop tends to proceed straightforward resulting in a more probable impact with the airfoil. This method was proven to be effective to evaluate ice accretion physics under extended icing conditions [13, 14], compliant with Appendix C and O environments, as long as the MVD does not exceed the range of typical freezing drizzle values. Therefore, by using only drop parameters, geometric characteristics of the hit body and LWC profile it is possible to calculate the total amount of water reaching the surface and, consequently, the actual ice accretion rate. For these reasons, the Simulink® model, shown in Fig. 8. for a wing, has been replicated for the other zones simply by changing the geometry.

The de-icing system block is the core of the whole simulation and it is actually the most complex since it has two sub-levels. The first level is described by the IBD represented in Fig. 9.

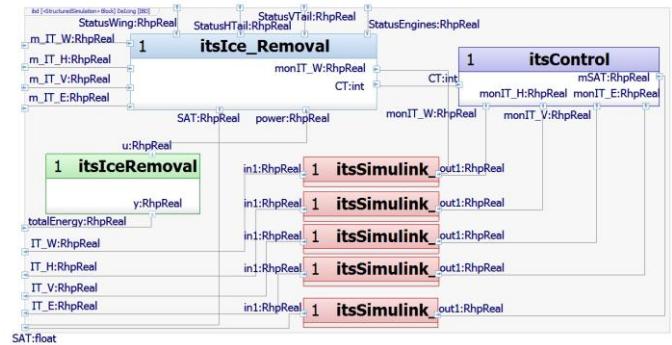

Fig. 9. IBD of the ice protection system

This context was specifically conceived in order to support different types of de-icing system solutions, allowing the user to choose the scenario for the simulation. The main block, which is actually another container (cyan), is the actuation subsystem that includes the models related to the system behavior (working sequence, dynamics etc...) whereas the control unit supports the de-icing control logic and fault detection for the different de-icing architectures. The upper part of the IBD is then representing the real system as combination of a control logic and a working machine. The blue blocks at the bottom represent the ice thickness sensors for the different aircraft zones and for the air temperature probe. The Digital Twin of the ice sensor has been implemented as a simple noise generator, receiving the correct

value of their variable from atmosphere and ice creation dynamics and adding a random signal to simulate sensor deviation. The de-icing control logic receives this data and regulates the cycle time, managing the system behavior. The actuation part follows a specific sequence that is influenced by the cycle time and it provides information about zones status, ice melting rate and power consumption. The green block is a simple integrator to evaluate the total energy provided by the system during its operation. The red blocks in the middle of Fig. 9 combine the data coming from the environment (atmosphere, ice accretion etc...) with the output of the de-icing systems to evaluate the global ice thickness level. They are simple models from Simulink® that add algebraically the values of grown and melted ice.

Looking in detail inside the cyan block of Fig. 9 (upper left), which is representing the actuation process, it is possible to analyze the IBD shown in Fig. 10.

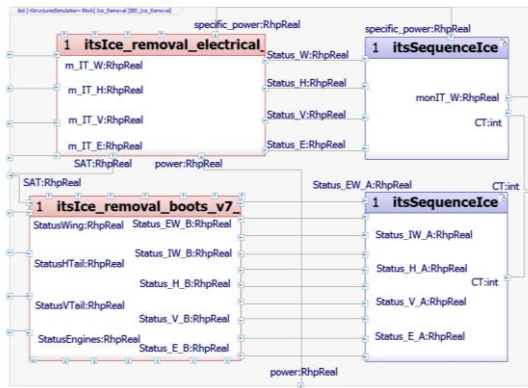

Fig. 10. IBD for ice removal (sequence and actuation)

The IBD for ice removal (Fig. 10) describes the implemented structure for the actuation part of the de-icing systems. The electro-thermal and the pneumatic solutions are developed in parallel and they can be connected depending on the scenario without changes in input/output structure, allowing a trade study. The two alternatives are realized through as a state-machine that regulates the sequence of activation of the different zones, receiving the data from the controller, and a dynamic model from Simulink® for what concerns the physics of the ice accretion phenomenon. The final outputs are the ice melting rate, the activation status for the different zones and the power consumption.

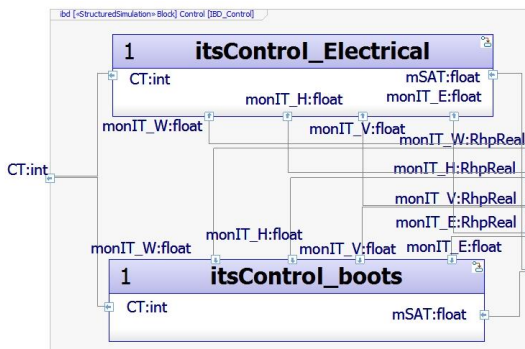

Fig. 11. IBD for alternative de-icing system controls

The IBD shown in Fig. 11 represents the internal structure of Control block of Fig. 10 (upper right blue block). As for the actuation part, the two controllers of Fig. 11 are implemented in parallel to compare the two alternative de-icing systems and they can be connected on demand in the simulation, such as for comparison over the same verification activities. Controllers are based on state-machines and they provide timing information that are evaluated thanks to the ice thickness and temperature measures coming from the sensors.

V. RESULTS OF APPLYING OPEN DIGITAL TWINS AND THREADS

A. Heterogeneous simulation results

Simulations have been performed using the Model-Exchange computation mode of FMU [7, 15]. This means that the simulation environment shall provide the solver for the resolution of the equations contained in the different blocks, which make up the Digital Twins for system functions, operating environment and mission. These are typically based upon proprietary or open source tools. Simulink®, OpenModelica and Dymola® are theoretically able to host the simulation, but the last one was selected because of its embedded open FMI compatibility, as opposed to Simulink® that requires a third party toolbox to be able of loading FMUs, and the supported Modelica environment (OpenModelica provides poor performance in terms of computation time and more work to tune the simulation is necessary). The structure described in Section IV was used to compare the performance of electrical and pneumatic boots de-icing systems under the atmospheric conditions specified by Appendix O and considering a typical mission time of 12000 s (approximately 3h20'). Ice accretion rates and ice thickness was monitored as long as power consumption during actuation cycle. The Dymola® model is shown in Fig. 12 for electro-thermal IPS scenario.

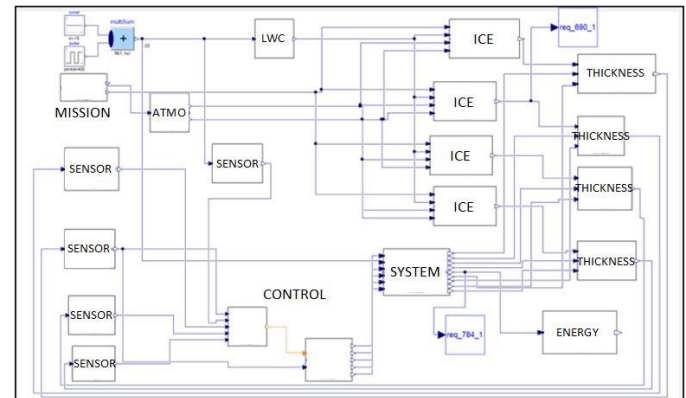

Fig. 12. Electro-thermal IPS scenario represented in Dymola®

Fig 13 shows ice thickness evolution during mission time for both electrical and pneumatic systems. The actual level is a combination of the ice accretion, which is different for each mission phase, and the melting action of the system. It can be clearly seen that the electrical de-icing system is based on a continuous control of the hypothesized threshold (0.020 m), since it is conceived to reduce the power consumption. The

boots system is instead based on the mechanical expulsion of ice layers and, in the nominal condition represented in Fig. 13, is able to quickly reduce the amount of ice that has been created on the aircraft with low power level.

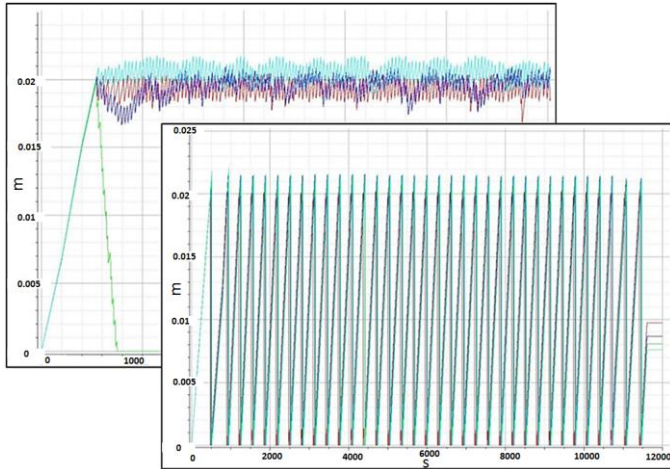

Fig. 13. Ice thickness evolution for electrical (left) and pneumatic (right) scenarios

For both alternative de-icing system types it is also interesting to see the evolution of ice level for the different zones (wing, horizontal tail, vertical tail and engines represented respectively in red, blue, green and cyan): depending on the action of the controller the zones are actuated to reduce the heat-off time and to manage power level. The result is a quite high melting efficiency of electrical system for some aircraft parts and, on the other hand, a not negligible lag of activation of the pneumatic boots (that may lead to the exceeding of the threshold). These aspects have to be considered during controller design, as part of overall de-icing system responsiveness.

The estimation of power consumption is shown in Fig. 14. For both electrical (blue) and pneumatic (red) systems the power level is driven by a number of peaks during the heat-on period, as a consequence of zones activation. Because of these small active periods over the whole de-icing cycle it is very important to analyse the power transients between the activation/deactivation of the neighbouring zones (upper right corner of Fig 14). This is considerably important for the electrical system due to the fact that the time lag required to reach the maximum power of one zone overlaps with that necessary for a complete shutdown of another zone. This leads to very high power level for very limited time, this peakiness can be seen in the left hand trace in Fig. 14. The same happens also for the boots system but, since the power level is considerably lower, the global effect is not so relevant for the computation of power budget. A direct comparison between the two systems reports that the boots system, when well regulated, is able to completely clean the selected surface from ice in 1-2 actuations. Moreover the pneumatic system requires only 10% of the power used by the electrical system (10-20 kW against 120-160 kW) in the same operating conditions. In fact, apart from the intrinsically high power consumption of a

cyclic electro-thermal system, it is necessary to consider that 40 kW are always required for continuous anti-icing.

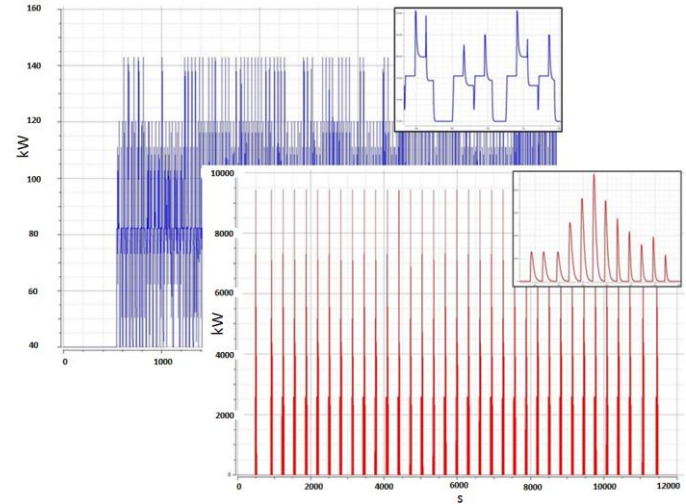

Fig. 14. Power consumption during mission for electrical (left) and pneumatic (right) systems

This is one of the most important differences between the two systems, since the electrical solution is designed to work both as anti-ice and de-icing system whilst the pneumatic one is mostly a de-icing unit. Functionality, power, response are important factors also traded against weight, lifecycle maintenance and cost for example.

Several other results can be considered since all the parameters included in the FMU can be plotted (energy, actuation status, atmospheric conditions). Applying FMU for digital twin in this way is very useful in terms of trade-off analysis since a parallel evaluation can be done quickly by replacing some parts of the simulation or simply by considering the results available at the end of the computation process. This is for example the case when a comparison between different operating conditions is requested, such as Appendix C and Appendix O icing environments, or, simply, when the use of mixed FMU export mode is envisaged for part of the sub-models (use of Co-Simulation FMU, for those model parts that required original solver to be compiled due to numerical and/or stiffness problems).

B. Creation and maintenance of Digital Twins and Threads

Digital Twins are formed for specific needs, as expounded above, and connected through Digital Threads, which are associations of relevance. However, these combinations can become new Digital Twins for additional needs along the lifecycle. In this work Digital Twins were created for the de-icing system operation, along with Digital Twins for the physical behaviour, physical world and physical operating mission (flight path): these were then combined, tailored and assessed for two alternative technology implementations using electro-mechanical rubber boots and electrical ice removal.

In summary, Fig. 15 shows some of the perspective addressed in this work and highlighted in this paper. The collection of relevant Digital Twins and Threads was increasingly managed under OSLC configuration

management. Notably, the following contributions for an overall Digital Twin were produced:

- Intent of a Digital Twin: a set of requirements specifications of an aircraft system and its lifecycle (realised using an approach based on ASD S1000D)
- Expected Functional behaviour of a Digital Twin: a set of models of the safe functional operation of an aircraft sub-system (realised using SysML)
- Operating environment Twin: a set of models of the related physical operating environment (realised in Modelica as FMUs using the CS-25 standard)
- Operating mission Twin: a set of models of an operating mission (implemented in OpenModelica)

Additionally various Digital Threads were produced and extended using OSLC, including:

- Digital Threads of regulatory requirements and tests to system components which meet them to compliance validation evidence
- Digital Threads of system operational performance requirements to system trade study measures and current design state metrics
- Digital Threads of allocation of system use cases, activities, operations to system functional units and product package concepts
- Digital Threads sets of configurations of related versions of the above models using open standards for distributed (multi-tool) configuration management
- Digital Threads of associations of engineering work, scoped requirements, impacted design & simulation models, relevant unit and system test procedures and their results
- Digital Threads of co-simulation interoperability between the functional and physical models using FMI and exposed with OSLC

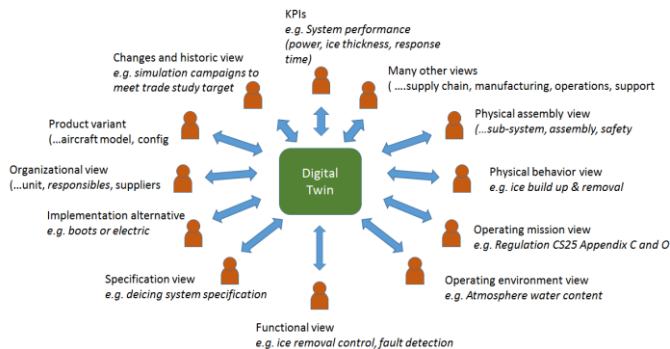

Fig. 15. Digital Twin overview with examples addressed in this work

Although not fully covered in detail here, a significant part of the work focused on exposing the Digital Thread relationships between the various Digital Twin models using OSLC, especially for dependencies, traceability and change impact

analysis. New views of relationships and traceability and ways of engaging with them were produced, allowing dependencies to be clearly seen, such as visibility of the evolution of the individual elements.

There was significant attention to build up the Digital Twins and Threads for maintainability, both in terms of using Change Request and Work items to direct work on models, controlling simulation runs using Test Plans, Cases, Scripts etc. and using configuration management to segment changes to simulation models. Model quality was mostly dealt with fidelity refinement, since formal quality management of the model Digital Twins was not undertaken, but the tools and methodology were available. During the project, this work was greatly extended as the OSLC Configuration Management specification was applied and new capability introduced, such as comparing configurations of multiple Digital Twins or contributing elements of Twins in the underlying tools.

VI. CONCLUSIONS

The concept of Digital Twins and Threads as used here to approach the design of complex and safety critical systems has been presented and applied to an aeronautical case study from CRYSTAL research project.

The effectiveness of the extensive use of interoperability standards to link Digital Twin coming from the simulation world has proven to be very efficient in reducing the workload required to connect the different elements of a wide IT infrastructure. OSLC and FMI standards have been used for lifecycle and non-lifecycle, e.g. inter-discipline, related interoperability. The primary conclusion is that using FMI to standardise Digital Twin interaction for simulation with OSLC for less constrained collaboration is a valuable combination, especially where the FMU components and their relationships within the models can also be exposed as OSLC resources, opening up new possibilities of value added applications for managing simulation assets for further gains in consistency and productivity. Moreover, the heterogeneous simulation has been proved as an effective alternative to the classical stand-alone approach for trade-off purposes. Notably, the heterogeneous simulation based on standards like FMI is a promising way to solve problems related both to tools interoperability and to complex systems characterization.

The proprietary languages, syntax and formats are, in fact, still a considerable issue when considering tool integration. The set-up of a hybrid scenario, on the contrary, is specifically conceived to allow models integration without introducing updates or modifications in the proprietary data, allowing to evaluate directly the results of the various simulations. Furthermore, a considerable benefit of such a type of simulation is the protection of intellectual property within a supply-chain scenario. Model providers, that may belong to different companies, shall deliver only the FMU version, exposing variables and parameters of their algorithms but not the algorithms themselves. The application of a heterogeneous simulation based on interoperability standards is then well suited to industrial domains. The results presented in Section V show that techniques of building up open Digital Twin and

Threads and using Heterogeneous Simulation is highly successful for functional and system performance analysis in a trade study setting. There is great opportunity to build up more support for day-to-day working and for dealing with change, planned or unexpected. Furthermore the trend is already to use more feedback from live running systems, such as in test, setup or operation with cognitive approaches using machine learning and artificial intelligence, so that, in this way, heterogeneous simulation along with operational predictive analysis will become vital techniques of exploiting the Internet of Things for new products and services by Industrial companies.

VII. OUTLOOK

The authors see and expect a growing industrial and academic interest in such open interoperability standards to enable open Digital Twins and Threads. Future research activities may deal with the extension of the Heterogeneous Simulation approach to further increase support Trade-off analysis and Change Impact Analysis activities. As shown in Fig. 16, generic engineering methods shall be instantiated for Change Impact Analysis and for trade-off analysis, relying on post-processing and simulation data that are exposed by the respective simulation and computation servers in a standard way. The formal methods to document and apply such methods were demonstrated by IBM and Airbus in the CRYSTAL project. The authors note that current work is augmenting such methods with the new cognitive and AI discovery analysis and advisors such as IBM Watson AI Assistant® [16] that apply deep search and cognitive machine learning over the relevance and usefulness of the offered information to the people in the process.

significant interest, especially with the joint focus of selecting an appropriate design through trade study, and the ability to investigate the available compliance Digital Twins and Threads for each combination will provide a better understanding of the speed and feasibility of the favored technical solution. In addition, the objective was to retrieve specific simulation results, such as the maximum accumulated ice on aircraft components or the maximum power peak, and represent them into a simpler graphical user interface (dashboard) as shown in Fig. 17.

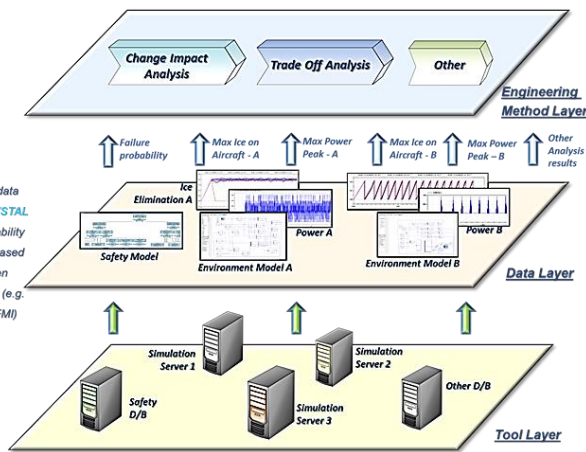

Fig. 16. Extension of heterogeneous simulation approach for trade-off analysis and change impact analysis

The techniques piloted here showed how information made available via OSLC allowed new views of different Digital Twin system alternatives using common models for environmental and mission simulation. Furthermore visibility of the work plan and state of the achievement against simulation results was piloted. This again is an area of

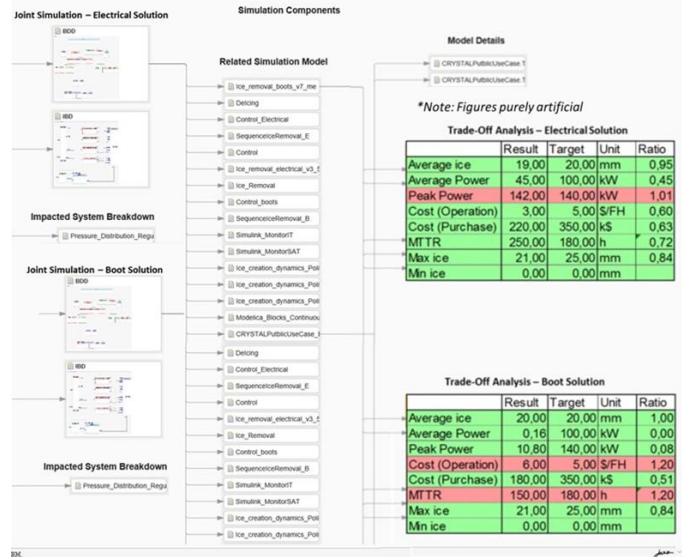

Fig. 17. Example dashboard concept for representing change impact and trade-off analysis

In this example two combined Digital Twin alternatives are evaluated against two CS-25 operational profiles (compliance requirement sets) with comparison of two key system operational performance measures of those simulation runs. In addition, authors envisage showing the trend of such KPIs over progressive simulation runs to understand under or over achievement trends. These kinds of techniques will become easier with the greater use of lightweight web technology and use of the above standards for open Digital Twins and Threads.

There is already new industry interest to support this scenario, i.e. extensions of the FMI and/or the OSLC standard are likely to be required and therefore the authors envisage a strong drive on these aspects with the availability of cloud computing and the Internet of Things. Recent work confirms this opportunity as a clear trend. An additional area of investigation is to connect new interaction methods such as Virtual Reality or speech recognition systems and machine learning based analytics with the formalized Digital Twin and Thread models shown above. In this way new engineering processes and techniques will become possible for accelerated innovation and problem solving.

REFERENCES

- [1] M. Grieves, J. Vickers, Digital Twin: Mitigating Unpredictable, Undesirable Emergent Behavior in Complex Systems. Transdisciplinary Perspectives on Complex Systems: New Findings and Approaches, Springer 2017, Switzerland.
- [2] E. Negri, L. Fumagalli, M. Macchi, A review of the roles of Digital Twin in CPS-based production systems. 27th International Conference on Flexible Automation and Intelligent Manufacturing (FAIM), 27-30 June 2017, Modena, Italy.
- [3] ARTEMIS Joint Undertaking. CRYSTAL Project. <http://www.crystal-artemis.eu/>
- [4] C. Pessa, M. Cifaldi, E. Brusa, D. Ferretto, K.M.N Malgieri, N. Viola, Integration of different MBSE approaches within the design of a control maintenance system applied to the aircraft fuel system. Proceedings of the 2016 IEEE International Symposium on Systems Engineering (ISSE), Edinburgh, Scotland, 2016.
- [5] I. Vagliano, D. Ferretto, E. Brusa, M. Morisio, L. Valacca, Tool Integration in the Aerospace Domain: a case study. Proceedings of the 41st IEEE Annual Computer Software and Applications Conference (COMPSAC), 4-8 July 2017, Torino, Italy.
- [6] OSLC – OASIS Open Services for Lifecycle Collaboration. <http://www.oasis-osl.org/>
- [7] MODELISAR Consortium. Functional Mock-up Interface for Model Exchange Version 1.0. <http://www.fmi-standard.org>
- [8] J. Holt, S. Perry, “SysML for Systems Engineering”, ed. 2008. The Institution of Engineering and Technology, London, UK.
- [9] European Aviation Safety Agency (EASA) (2015). Certification Specification for Large Aeroplanes CS-25 Amendment 17.
- [10] A. Tundis, D. Ferretto, A. Garro, E. Brusa, M. Mühlhäuser. Dependability assessment of a deicing system through the RAMSAS method. Proceedings of the IEEE International Symposium on Systems Engineering, 11-13 October 2017, Vienna, Austria.
- [11] Federal Aviation Administration (FAA) (2003). Experimental Study of Supercooled Large Droplet Impingement Effects, DOT-FAA-AR03/59. Office of Aviation Research. Washington D.C.
- [12] SAE Aerospace (2004). Applied Thermodynamics Manual – Ice, Rain Fog and Frost Protection, AIR1168/4.
- [13] O. Meier, D. Scholz, (2010). A handbook method for the estimation of power requirements for electrical de-icing systems. Hamburg University of Applied Science.
- [14] D. N. Anderson, J. C. Tsao, (2003). Overview of Icing Physics Relevant to Scaling. Ohio Aerospace Institute.
- [15] Blochwitz, T., et al. The Functional Mockup Interface for Tool independent Exchange of Simulation Models. 8th International Modelica Conference.
- [16] IBM Corporation, IBM Watson: Products and Services. AI Assistant.



G. Bachelor is a senior Solution Architect in the IBM Watson IoT Development organization. He has 40 years of experience in complex system design from semiconductor devices, industrial systems, enterprise IT, mobile and cloud in high-tech industries involving supply chains, academia and collaborative EU projects.

With a deep background in safety critical embedded industrial control systems, Gray has a particular focus on cross-discipline collaboration including interoperability across ALM, PLM and MBSE.



E. Brusa received a M.Sc. degree in Aeronautical Eng at the Politecnico di Torino (1993), and a PhD in Machine Design (1997). Assistant professor in Machine Design (1998), he appointed associate (2002), then full professor in 2010 (being enrolled in 2013). He belongs the Dept. of Mechanical and Aerospace Eng. of the Politecnico di Torino, being leader of the research group in Model Based Industrial Systems Engineering. Since 2018 is head of Doctoral School at Politecnico di Torino.



D. Ferretto received the B.Sc. (2012) and M.Sc. (2014) degrees in Aerospace Eng. from the Politecnico di Torino, Italy. Since 2014 is Research Assistant at the Dept. of Mechanical and Aerospace Engineering of the Politecnico di Torino. He enrolled the PhD program in Aerospace Engineering at the same institution in 2016. His research activities concern the design of aerospace systems for conventional and innovative aircraft as well as the Systems Engineering methods and tools.



A. Mitschke is working as Senior Scientist for the Virtual Product Engineering Department of Airbus Central R&T. He holds an MBA from the University of Rhode Island and an engineering degree from TU Braunschweig. Andreas is working for the Airbus Company since 2004. He was first working on joint Airbus

France/EADS IW research projects in Toulouse and Munich with the focus on topics around System Layout Integration, tool and data integration, and model-based Systems Engineering. From 2009 to 2018 Andreas was working at Airbus Group Innovations (AGI) in Hamburg, where he had been involved among others in Requirements Management Projects and in Customization Reengineering Projects of the Airbus Programs, including A350.