



POLITECNICO DI TORINO
Repository ISTITUZIONALE

Maintenance Activity, Reliability Analysis and Related Energy Losses in Five Operating Photovoltaic Plants

Original

Maintenance Activity, Reliability Analysis and Related Energy Losses in Five Operating Photovoltaic Plants / Spertino, F.; Chiodo, E.; Ciocia, A.; Malgaroli, G.; Ratclif, A.. - (2019), pp. 1-6. ((Intervento presentato al convegno 19th IEEE International Conference on Environment and Electrical Engineering and 2019 IEEE Industrial and Commercial Power Systems Europe, IEEEIC/I and CPS Europe 2019 tenutosi a Genova, Italy, nel 11-14 June 2019 [10.1109/IEEEIC.2019.8783240].

Availability:

This version is available at: 11583/2756054 since: 2020-01-21T14:30:07Z

Publisher:

Institute of Electrical and Electronics Engineers Inc.

Published

DOI:10.1109/IEEEIC.2019.8783240

Terms of use:

openAccess

This article is made available under terms and conditions as specified in the corresponding bibliographic description in the repository

Publisher copyright

(Article begins on next page)

Maintenance Activity, Reliability Analysis and Related Energy Losses in Five Operating Photovoltaic Plants

Filippo Spertino
Dipartimento Energia "Galileo
Ferraris"
Politecnico di Torino
Torino, Italy
filippo.spertino@polito.it

Elio Chiodo
Dipartimento di Ingegneria Industriale
Università degli Studi di Napoli
Napoli, Italy
elio.chiodo@unina.it

Alessandro Ciocia
Dipartimento Energia "Galileo
Ferraris"
Politecnico di Torino
Torino, Italy
alessandro.ciocia@polito.it

Gabriele Malgaroli
Dipartimento Energia "Galileo
Ferraris"
Politecnico di Torino
Torino, Italy
gabriele.malgaroli@polito.it

Alessandro Ratclif
Dipartimento Energia "Galileo
Ferraris"
Politecnico di Torino
Torino, Italy
alessandro.ratclif@polito.it

Abstract—The majority of Photovoltaic (PV) plants do not include components with moving parts and often they are wrongly considered maintenance-free. The present work consists of a Reliability Analysis (RA) of five PV systems with different size from 50 kW to 1 MW. The exponential distribution is used to calculate the reliability of electrical components, and failure rates are derived from literature. The results are compared to experimental data, obtained by the analysis of maintenance activity in two years of life of the PV plants. In addition, the calculation of the related energy losses of the PV plants is presented. From these results, it can be argued that, in some cases, energy losses are not negligible.

Keywords—photovoltaic systems, reliability, maintenance engineering, power system faults

I. INTRODUCTION

Nowadays, the penetration of Renewable Energy Sources (RES) in electric power systems is rapidly increasing due to the economic crisis and the requirement of environmental protection. Photovoltaic (PV) technology is one of the most important, because it is inexhaustible and environmentally clean. PV modules require low maintenance, have long lifetime and are the most important components of solar systems, because their reliability highly affects the performance of PV generators.

During normal operation, external factors (temperature, irradiance, weather conditions, etc.) affect the performance of PV modules, resulting in a possible reduced efficiency or an outage of the operation of the whole system. In addition to the natural performance degradation, in order to estimate the production of PV generators, it is necessary for the operator to assess the possible failures, performing a Reliability Analysis (RA) of the system.

In the power system domain, several papers investigate the reliability of the network in terms of global variable (for example by calculating the energy not supplied), both with multi-objective [1] and single-objective formulation [2]. Nevertheless, not many papers, evaluating the reliability of PV generators at system level, are available in literature. At component level, [3] performs a long-term reliability analysis using Markov method. In [4] the reliability of the PV junction box based on a 1 GW field database is investigated. In [5] the reliability of PV micro-inverters through the MIL-HDBK-217 is estimated.

In [6] and [7] it is evaluated the degradation of PV panels and the reliability strictly connected to faults caused by climate variations. In [8] a novel set of risk indexes is identified to improve a traditional Risk Analysis of PV modules, based on Failure Mode Effect and Criticality Analysis. In [9] several Reliability Block Diagrams are proposed to evaluate the reliability of different topologies of PV generators.

The present paper proposes a RA at system level of five grid-connected PV plants, using a Fault Tree Analysis (FTA) to identify the most critical components of each plant. Then, an energy analysis is performed at system level and component level. In particular, the yearly energy losses, due to failures and faults of the plants under study, and the individual contributions of each faulty component to the total amount of energy loss are estimated.

The next sections of the paper will be organized as follows. In the second section, the reliability models used in the first analysis is described. In the third section, the results of the RA and an energy loss analysis are shown. In the fourth section, the conclusions are presented.

II. RELIABILITY MODEL APPLIED TO PV PLANTS

A. Reliability theory

The reliability analysis consists of a method to define the probability of success of a system; that is, the probability that an object (component, subsystem or system) performs its required functions for a defined period of time Δt under some environmental and operational conditions [10]. In order to perform a correct and complete RA, it is necessary to calculate some parameters, shortly described below.

The Failure Rate (λ) is the frequency with which a component or system fails, and it is expressed in number of failures per unit of time [11]. Fig. 1 shows a typical curve of the failure rate, commonly known as "bathtub curve", as a function of time. The shape of the curve shows that the life cycle of a component can be divided into three different time-periods: the burn-in period, the useful life and the degradation period.

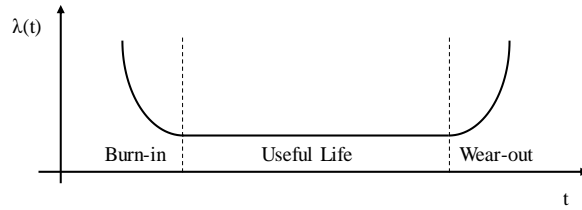

Fig. 1 Bathtub curve.

Although components are tested to reduce the infant mortality, due to design or production errors, there are undetectable defects resulting in a high failure rate at the beginning of life. After the initial break-in period, the failure rate tends to stabilize at a relatively constant level during its useful life. After this period of time, the item begins the wear out period, in which the failure rate dramatically increases [12].

The failure rate $\lambda(t)$ is closely related to the reliability function $R(t)$ by the equation (1):

$$\lambda(t) = \lim_{\Delta t \rightarrow 0} \frac{R(t) - R(t - \Delta t)}{R(t) \cdot \Delta t} = -\frac{1}{R(t)} \cdot \frac{dR(t)}{dt} \quad (1)$$

Thus, the probabilistic failure model is based on the following integral relationship which allows to evaluate the reliability function $R(t)$ starting from the failure rate function $\lambda(t)$:

$$R(t) = \exp \left[-\int_0^t \lambda(t) dt \right] \quad (2)$$

The above equation fully determines what the Reliability function $R(t)$ is. With the hypothesis that the reliability is unitary (i.e., the component is fully functional) at the beginning of life $R(t=0) = 1$.

Great part of reliability models assumes that the initial burn-in period is over, and the wear-out period is remote; i.e., the reliability analysis is performed only in the useful life. This simplification permits to consider a failure rate independent of time (3) and the calculation of reliability in complex system is simpler and faster. If the failure rate $\lambda(t)$ is constant, then it can be shown that this is the only case in which the reliability model follows the simplified exponential distribution, i.e.:

$$R(t) = \exp[-\lambda t] \quad (3)$$

Another important parameter is the Mean Time To Failure (*MTTF*) and it is the expected average time before an error or failure occurs in a component or in a system. The *MTTF* does not depend on a particular time period and it is used for the comparison of various systems. The relationship between *MTTF* and the reliability function is described by (4).

$$MTTF = \int_0^\infty R(t) dt \quad (4)$$

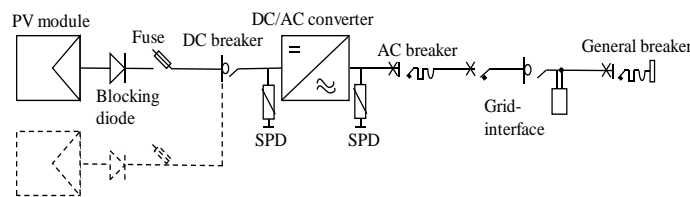

Fig. 2 Simplified scheme with the main components of a PV plant.

If the failure rate $\lambda(t)$ is constant, the *MTTF* is the inverse of the failure rate: $MTTF=1/\lambda$.

The Mean Time To Repair (MTTR) is the average time occurring between a failure and the restoration of the system to the state before the failure [13]. The repair time depends on several factors: the fault diagnosis process, the availability of the components to be replaced, the logistic delay, the complexity in maintenance, and so on.

To reduce MTTR, the maintenance manager could increase the number of components in stock to facilitate the replacement of faulty devices or schedule a frequent check of the components more subject to failures, to quickly start the repair process [14].

B. Description of the main components of PV plants and their failure rates

According to [15], there are different possible layout typologies and configurations of photovoltaic plants, resulting in a very different number of components. Therefore, there is no single scheme that describes exactly every type of plant. However, to

perform the FTA analysis, it is possible to describe the PV systems with a simple standard single-line diagram, that broadly describes the sequence and function of the main components (Fig. 2). To do this simplification, the undesired event of the analysis corresponds to a loss of production of the plants due to the failure or the breakage of a component. In our analysis, the undesired event could be caused, for example, by the failure of a diode, connected to a single string, or the failure of the general breaker upstream of the whole plant. Thus, the simplified scheme of PV plant (Fig. 2) shows that all the components are connected in series. The loss of production due to mismatch or low irradiance is not considered.

The standard PV plant that has been considered to perform RA consists of the following components:

- PV modules are one of the most numerous components of PV systems. Each module includes several PV cells (generally 60 or 72 connected in series with some by-pass diodes) [16]. The series and parallel connection of the modules constitute the PV array, and the field. The most diffuse PV technologies are monocrystalline silicon (m-Si), polycrystalline silicon (p-Si), and thin film [17]. The failure rate for PV modules is about $4.6 \cdot 10^{-8}$ failures/hour [18].
- PV connectors permit the links between PV modules. They are made by a copper core and an external plastic insulation, that can resist to weather (in particular rain, heat and UV light). Each PV module is equipped with two connectors, corresponding to the positive and the negative terminals [19]. The failure rate for the connectors is about $2.4 \cdot 10^{-10}$ failures/hour [20].
- Fuses are circuit breakers made of an internal filament that melts, when an overcurrent occurs in the system, therefore, interrupting the circuit [21]. Each PV string can be equipped with two fuses and the failure rate for fuses is $9.4 \cdot 10^{-8}$ failures/hour [22]. In this case, the failure rate refers to the correct operation of the component (i.e., the interruption of over-currents), which results in its consequent blown.
- Blocking diodes avoid the reverse current flow in shaded string [21]. Thus, in big arrays, each PV string is generally equipped with a blocking diode. The failure rate is $6.9 \cdot 10^{-8}$ failures/hour [20].
- The DC breaker disconnects the PV array from the DC/AC converter. The number of DC breakers changes in the plants, it can be a unique device for the whole array or multiple switches (one for each PV string). The failure rate of a DC switch is assumed $3.8 \cdot 10^{-7}$ failures / hour [20].
- The DC/AC converter permits the connection of the PV generator to the AC grid. This device includes hardware and software to extract maximum power from the PV generator also under electrical mismatch of PV cells [23]. The failure rate assumed for inverters is $3.2 \cdot 10^{-5}$ failures/hour [24].
- The automatic AC circuit breaker is a device that can electrically separate two parts of an AC line. In the present work, each plant is equipped with one or more AC circuit breakers and the failure rate is $1.7 \cdot 10^{-6}$ failures/hour [20].
- The grid interface device has the function of checking that the voltage source is within its root mean square and frequency limits. According with [20], the failure rate is assumed $3.4 \cdot 10^{-6}$ failures / hour.
- General AC breaker, often motorized and coupled with a Residual Current Device (RCD), installed immediately before the grid connection, is used to disconnect the entire plant from the grid. The failure rate that has been assumed for the general AC breaker is $3.8 \cdot 10^{-7}$ failures/hour [20], while the failure rate related to the RCD is $1.7 \cdot 10^{-6}$ failures/hour [20].

There are components, such as the Surge Protection Device (SPD) and the energy meter, that are fundamental for the correct operation of the PV plant. Nevertheless, these components are not included in the reliability analysis. In general, in case of failure, they cannot guarantee their function, but they do not produce the undesired event analyzed in the present work; i.e., the reduction in power production.

C. Fault-tree analysis of PV generators

In order to identify the cause and the probability of a fault, it is necessary to study the interdependencies between system components. The FTA identifies which components are involved in undesired event (loss of energy in the PV plant) and the related causes and probability of failure [22].

The undesired event could be a failure or the breakage of a component affecting the correct operation of the system. In the present work, an incorrect operation consists of the interruption or decrease in PV energy production. The natural degradation over time of power production, due to performance reduction of the PV modules [25], is not considered in the FTA.

In the fault tree of a PV plant (Fig. 3), based on the scheme and the assumption defined in subsection II.B, if an element fails, the whole system will fail. For the sake of simplicity, failure events are considered independent from each other's. Obviously, the elements of the PV system are considered well sized and correctly installed. In addition, in order to calculate the system reliability, it is supposed that the system is not repairable. In this way, according to [24], it is possible to calculate the mean time before the first failure.

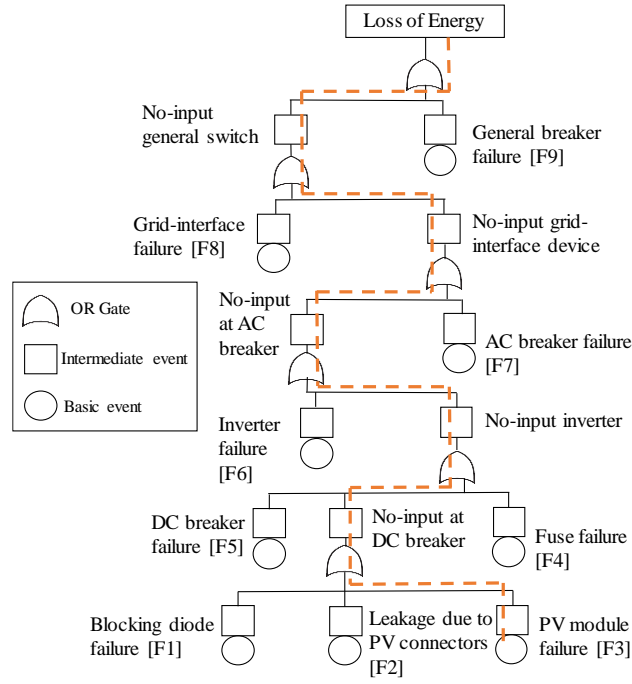

Fig. 3 Fault tree of a PV plant.

The Fault Tree in Fig. 3 is represented on six levels that correspond to the different system levels of the plant and the possible faults considered are numbered from F1 to F9. For example, if a PV module failure occurs, the dashed red line, in the FT, shows the path of this specific fault. The failure of the PV module affects the energy passing in the DC breaker. It means that there is a lower energy fed to the inverter. As a consequence, the input at the AC breaker is lower, such as in the grid interface and in general switch. As a conclusion, the energy injected to the grid is lower, i.e. there is an energy loss.

To calculate the system reliability, first the FTA must be transformed into a Boolean expression, then into a probabilistic equation. Thus, it is defined the smallest combination of basic events that can determine the plant failure. As represented in Fig. 3, all the basic and intermediate events are connected through OR gates, this means that every fault occurring in the tree will propagate to the top event. As a consequence, the probability that the undesirable event will be the summation of the probabilities of the single events. The probabilistic equation (5) derived from the Boolean expression is:

$$\Pr(TopEvent) = \Pr(F1 + F2 + \dots + F9) \quad (5)$$

Consequentially, the formula, based on the exponential distribution, used for the calculation of the reliability is equation (6) [24]:

$$R(t) = \exp[-t \sum_{i=1}^n c_i \lambda_i] \quad (6)$$

where c_i is the number of identical components in a plant, λ_i is the failure rate of each element i , n is the total number of different components and t is the considered time. Regarding the time, it is expressed in hours, and an average operation time of 12 hours per day has been considered, because there is an average value of 12 light-hours per day over a year.

III. RELIABILITY ANALYSIS ON OPERATING PV PLANTS

A. Description of the five PV plants under study

Five different PV plants are analyzed in terms of maintenance, accessing to maintenance reports, monitoring data and technical datasheets. The PV plants are all located in Northern Italy and characterized by a comparable life, but with different rated powers. The first plant (plant #1) has a rated power of 50 kW and was built in 2011. It is composed of five inverters and a total of 216 p-Si modules.

The second plant (#2) has a rated power of 150 kW, and started working in 2009. Its PV array is composed of 1472 thin-film modules and 9 different DC/AC converters with sizes ranging from 4 to 20 kW.

The third plant (#3) has an installed power of 260 kW and was built in 2011. It consists of 1125 p-Si modules and 12 inverters, each with rated power of 33 kW.

The fourth plant (#4) is characterized by a rated power of 550 kW (2375 p-Si modules) and started working in 2010. The power conditioning consists of 5 inverters.

The PV plant #5 has the largest rated power (1 MW) and works since 2011. The plant is characterized by several multi-string inverters, each one with rated power of 17 kW. The number of components for each plant is shown in Table I.

B. Reliability study based on theoretical data

Starting from the failure rates values from literature (subsection II.B) taken from specialized literature, the fault tree analysis is used to calculate the reliability of the five plants under analysis. Table II shows the reliability of the groups of components after 10 years; i.e., the probability of finding at least one broken component within each category.

Fig. 4 shows the evolution vs. time of the reliability of the whole plants. In particular, starting from the second year, for all the plants (only the plant #1 is excluded) the need for maintenance is theoretically certain.

Obviously, the reliability of PV plants generally decreases with increasing installed power, because bigger plants are composed of a higher number of components.

However, there is an exception, in fact plant #4 (553kW), despite having a power higher than plant #3 (258kW), shows a greater reliability. In particular, the plant #4 has less inverters, which are the components with the highest failure rate and have a greater influence on overall reliability. In addition to the reliability analysis, it is calculated the *MTTF* of each whole plant.

TABLE I. NUMBER OF COMPONENTS IN THE ANALYZED PV PLANTS

Plant	#1	#2	#3	#4	#5
Nominal power [kW]	50	150	260	550	1000
Number of components					
PV modules	216	1472	1125	2375	4284
Connectors	432	2944	2250	4750	8568
Fuses	32	410	142	224	380
Diodes	16	205	71	112	190
DC breakers	16	19	23	50	69
DC/AC converters	4	9	15	12	69
AC breakers	4	9	15	12	69
Grid interface	1	1	2	2	2
General AC breaker	1	1	2	2	2

TABLE II. RELIABILITY OF COMPONENT GROUPS AFTER 10 YEARS

Plant	#1	#2	#3	#4	#5
Reliability of groups of components after 10 years					
PV modules	0.657	0.022	0.112	0.01	0
Connectors	0.998	0.98	0.989	0.976	0.958
Fuses	0.881	0.198	0.57	0.413	0.223
Diodes	0.955	0.551	0.814	0.722	0.576
DC breakers	0.775	0.738	0.693	0.45	0.333
DC/AC converters	0.004	0	0	0	0
AC breakers	0.751	0.526	0.342	0.424	0.007
Grid interface	0.867	0.867	0.751	0.751	0.751
General AC breaker	0.984	0.984	0.969	0.969	0.969
ENTIRE PLANT	0.001	0	0	0	0

It is calculated with the following formula (7).

$$MTTF = 1 / \sum_{i=1}^n c_i \lambda_i \quad (7)$$

The results show that the PV plant #1 only needs about one intervention per year ($MTTF \approx 1.2$ year), while in the plants #2, #3 and #4 there will be between 2 and 3 annual faults, respectively ($MTTF \approx 0.32$ and 0.42). The worst one is the plant with the highest nominal power (1MW, plant #5); it presents a theoretical failure rate much higher with more than one estimated damage per month ($MTTF \approx 0.07$).

C. Reliability study based on experimental data

The plants, examined from a theoretical point of view in the previous paragraphs, are now studied from an experimental point of view. Maintenance reports are the inputs and then faults are counted and analyzed. The goal is to compare the theoretical model with the real case to understand how much this estimation can be accurate.

This analysis has been carried on collecting data during maintenance in years 2016 and 2017. The list of the faults, divided per category and plant, are report in Table III. Diodes, DC breakers and general AC breaker are not present, because no failures

occurred. Through the number of failures occurred in a specific time interval, the *MTTF* is calculated as the ratio between the operation time and the number of failures. Analyzing the monitoring system, it was possible to calculate the time needed to repair each failure and to calculate the *MTTR*. The comparison between theoretical and experimental. It is the ratio between the total repair time and the number of failures.

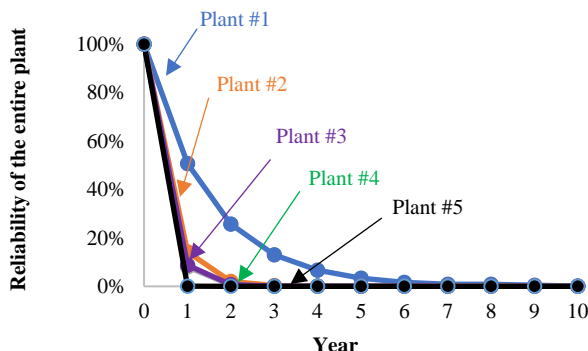

Fig. 4 Evolution of PV plant reliability during 10 years.

TABLE III. NUMBER OF MAINTENANCE WORKS

Plant	#1	#2	#3	#4	#5
PV modules	-	4	3	1	1
Connectors	1	1	2	1	3
Fuses	3	-	1	1	1
DC/AC converters	2	-	2	4	9
AC breakers	-	-	1	1	-
Grid interface	-	1	-	-	-

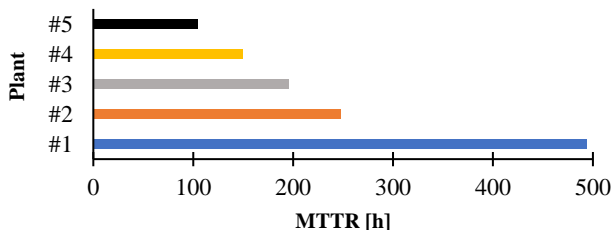

Fig. 5 Average experimental *MTTR* per plant.

Fig. 5 shows that *MTTR* decreases as the installed power of the plant increases.

The *MTTR* increase is due to maintenance costs. Generally, small PV power plants are characterized by cheap maintenance contracts, while for bigger PV power plants the maintenance contracts are more restrictive in terms of speed and reduction of production loss. In particular, Fig. 6 shows that failures due to fuses or faults in the inverter hardware are the most expensive in terms of *MTTR*. Actually, in case of failure of inverter hardware, a specialized technician shall be called with related delay. On the other hand, fuses are not immediately restored, because sending a worker only for a fuse seems to be more expensive than the related energy loss.

MTTF shows that, for all the plants (except #5), the calculated data are more optimistic than experimental results. It is consistent with the assumption of considering the plant as a not repairable system. Indeed, after the first failure, it is replaced only the damaged element, while the others continue working.

Experimental and theoretical *MTTF* are comparable for plants #2, #3, #4, while they widely differ for plants #1 and #5. In case of plant #1, the low *MTTF* is probably due to a not perfect realization of the plant. In particular, fuses could be not correctly installed; e.g. subject to excessive thermal stress.

Finally, the calculation of energy losses due to maintenance is performed, analyzing the maintenance reports and monitoring system. Losses correspond to the difference between the measured production and the expected production.

In case of failure of part of a plant, the expected production is obtained from the production of other well working converters of the same plant with the same characteristics (e.g. number of modules, tilt, azimuth). On the other hand, in the rare cases of disconnection of the whole plant, it is used a theoretical energy estimation model [26].

TABLE IV. ENERGY LOSSES DUE TO MAINTENANCE

Plant ID	#1	#2	#3	#4	#5
Energy loss [%]	-8%	-1%	-1%	-1%	<-1%

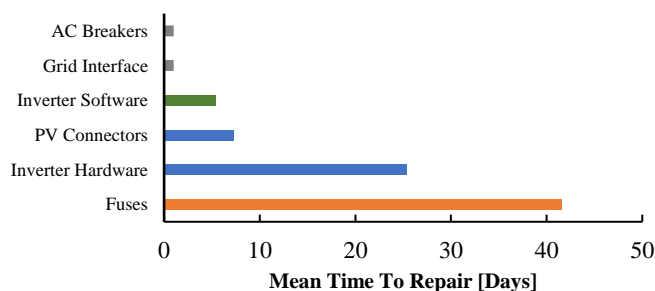

Fig. 6 MTTR per category of failure.

Fig. 7 Comparison between theoretical and experimental *MTTF*.

Table IV shows that all the PV systems considered, except plant #1, which is probably affected by design issues, have an energy loss $\leq -1\%$.

This value could be used as an additional loss in energy models to better estimate energy production and net present value of a new plant.

IV. CONCLUSIONS

The present work presents a reliability analysis of five photovoltaic plants. Experimental results demonstrate that the maintenance activity can have a fundamental importance for the correct operation of PV plants. As a rule, the theoretical values of mean time to failure are more optimistic than the experimental data for the PV plants under study. In particular, the theoretical durations are hundreds of hours greater than the experimental durations, except for the plant #5 (the largest one reaching the megawatt scale), where the experimental *MTTF* (≈ 600 h) is double with respect to the theoretical *MTTF*. Applying the proposed methodology, the theoretical values of *MTTF* vary greatly according to the power ratings, ranging from ≈ 400 h to ≈ 6000 h. On the contrary, the experimental durations are more similar, ranging from ≈ 600 to ≈ 1500 h. Except for the PV plant #1 (tens of kilowatt), that exhibits significant energy losses ($\approx -8\%$), the energy losses due to failures are low but not totally negligible ($\approx -1\%$). As a result, losses from failures equal to 1 % should be used as a reference value for PV plants with rated power from a few kilowatts to several megawatts. This amount can be included in the set of losses used for PV production assessment. Then, this parameter can be considered as a threshold for the identification of PV plants affected by specific problems, such as a wrong design and installation, or low quality components. As a conclusion, the used procedure can be the starting point to identify plants affected by technical issues. In future papers, the present work will be extended to a higher number of PV plants for more years. The goal will be to obtain more accurate maintenance parameters, and their dependence on the different installation typologies and the PV array-inverter configurations.

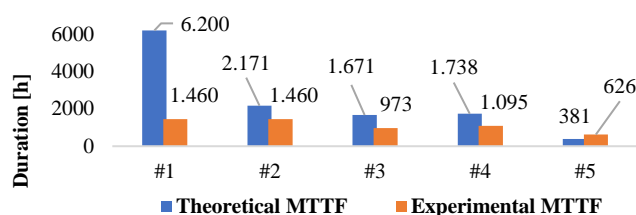
REFERENCES

- [1] A. Mazza, G. Chicco, M. Rubino, Hierarchy Process Multi-objective distribution system optimization assisted by Analytic Hierarchy Process, 2012 IEEE International Energy Conference and Exhibition (ENERGYCON 2012), 9-12 Sep 2012, Firenze (Italy)
- [2] P.M. De Quevedo, J. Contreras, A. Mazza, G. Chicco, R. Porumb, "Reliability Assessment of Microgrids With Local and Mobile Generation, Time-Dependent Profiles, and Intraday Reconfiguration," *IEEE Transactions on Industry Applications* vol. 54, 2018, pp 61-72.
- [3] A. Khalilnejad, M. M. Pour, E. Zarfshan and A. Sarwat, "Long term reliability analysis of components of photovoltaic system based on Markov process. SoutheastCon 2016. Norfolk, VA, 2016. pp. 1-5.
- [4] M. Chang et al., "The reliability investigation of PV junction box based on 1GW worldwide field database," 2015 IEEE 42nd Photovoltaic Specialist Conference (PVSC), New Orleans, LA, 2015, pp. 1-4.
- [5] F. Obeidat and R. Shuttleworth, "Reliability prediction of PV inverters based on MIL-HDBK-217F N2," 2015 IEEE 42nd Photovoltaic Specialist Conference (PVSC), New Orleans, LA, 2015, pp. 1-6.
- [6] K. Yedidi, S. Tatapudi, J. Mallineni, B. Knisely, J. Kutiche and G. Tamizhmani, "Failure and degradation modes and rates of PV modules in a hot-dry climate: Results after 16 years of field exposure," 2014 IEEE 40th Photovoltaic Specialist Conference (PVSC), Denver, CO, 2014, pp. 3245-3247.
- [7] A. Altamimi and D. Jayaweera, "Reliability performances of grid-integrated PV systems with varying climatic conditions," IET International Conference on Resilience of Transmission and Distribution Networks (RTDN 2017), Birmingham, 2017, pp. 1-6.
- [8] Y. Rongbin, L. Guixiong and Xiaoli, "Failure Risk Analysis of the PV Modules Based on the Improved FMECA Method." Fifth International Conference on Instrumentation and Measurement. Computer, Communication and Control, Qinhuangdao, 2015, pp. 1166-1170.

- [9] X. Shi and A. M. Bazzi. "Solar photovoltaic power electronic systems: Design for reliability approach." 17th European Conference on Power Electronics and Applications, Geneva. 2015, pp. 1-8.
- [10] Y. Song and B. Wang. "Survey on Reliability of Power Electronic Systems," *IEEE Transactions on Power Electronics*. vol. 28. no. 1. pp. 591-604. Jan. 2013
- [11] F. Obeidat and R. Shuttleworth. "Reliability prediction of PV inverters based on MIL-HDBK-217F N2." in *Proc. 2015 IEEE 42nd Photovoltaic Specialist Conf.* pp. 1-6.
- [12] M. Cooper. "Observations on Component Infant Mortality and Burn-In Effectiveness." in *IEEE Transactions on Components and Packaging Technologies*. vol. 31. no. 4. pp. 914-916. December 2008.
- [13] T. E. Wing and L. H. Crow. "A model for mean-time-to-repair and mean-logistics-delay-time at the system level." Annual Proceedings on Reliability and Maintainability Symposium. Los Angeles. CA. USA. 1990, pp. 389-393.
- [14] C. Bufi, A. Elasser, M. Agamy. "A system reliability trade-off study for centralized and distributed PV architectures." IEEE 42nd Photovoltaic Specialist Conference, New Orleans. LA. 2015, pp. 1-5.
- [15] F. Spertino. G. Chicco. A. Ciocia. G. Malgaroli. A. Mazza and A. Russo. "Harmonic distortion and unbalance analysis in multi-inverter photovoltaic systems." in Proc. 2018 International Symposium on Power Electronics. Electrical Drives. Automation and Motion, pp. 1031-1036.
- [16] M. Orkisz. "Estimating effects of individual PV panel failures on PV array output." 2016 IEEE 16th International Conference on Environment and Electrical Engineering (EEEIC). Florence, 2016, pp. 1-5.
- [17] N. H. Zaini at all. "The effect of temperature on a mono-crystalline solar PV panel." 2015 IEEE Conference on Energy Conversion. Johor Bahru, 2015, pp. 249-253.
- [18] T. Oozeki, T. Yamada, K. Kato, T. Yamamoto "An analysis of reliability for photovoltaic systems on the field test project for photovoltaic in Japan." In: Proc. ISES Solar World Congress; (2007), pp. 1628-1632.
- [19] B. Bahaj. P. James and J. McBride. "Photovoltaic connector behaviour under accelerated fretting testing regimes." Proceedings of the Forth-Seventh IEEE Holm Conference on Electrical Contacts (IEEE Cat. No.01CH37192). Montreal, Quebec, Canada, 2001, pp. 203-208.A
- [20] Reliability prediction of electronic equipment. MIL-HDBK-217F. 217F Notice 1, Washington DC, USA, Departement of Defense; 1991-92-95.
- [21] J. C. Gomez. D. Tourn. S. Nesci and G. R. Zamarillo. "PV cells protection by using class PV fuses." in *IEEE Latin America Transactions*. vol. 11. no. 1. pp. 531-537. Feb. 2013
- [22] A. Golnas. "PV System Reliability: An Operator's Perspective." in *IEEE Journal of Photovoltaics*. vol. 3. no. 1. pp. 416-421. Jan. 2013.
- [23] F. Spertino. J. Ahmad. P. Di Leo and A. Ciocia. "A method for obtaining the I-V curve of photovoltaic arrays from module voltages and its applications for MPP tracking." in *Solar Energy*. vol. 139, pp. 489-505, 2016.
- [24] G. Zini. C. Mangeant, J. Merten. "Reliability of large-scale grid-connected photovoltaic systems." *Renewable Energy*, vol. 36, no. 9, pp. 2334-2340, 2011.
- [25] A. Carullo. A. Castellana. A. Vallan. A. Ciocia. F. Spertino. "Uncertainty issues in the experimental assessment of degradation rate of power ratings in photovoltaic modules." in *Measurement*. vol. 111, pp. 432-440, 2017.
- [26] F. Spertino, J. Ahmad, A. Ciocia, P. Di Leo, "How much is the advisable self-sufficiency of aggregated prosumers with photovoltaic-wind power and storage to avoid grid upgrades?," Proceedings of IEEE Industry Applications Society Annual Meeting, 2017, pp. 1-8.