

Beam Scanning Reflectarrays for DTH application: preliminary results

Original

Beam Scanning Reflectarrays for DTH application: preliminary results / Pirinoli, Paola; Lohrey, Thomas; Orefice, Mario; Beccaria, Michele; Dassano, Gianluca. - (2019). (Intervento presentato al convegno EuCAP 2019).

Availability:

This version is available at: 11583/2738197 since: 2019-06-28T17:45:03Z

Publisher:

IEEE

Published

DOI:

Terms of use:

This article is made available under terms and conditions as specified in the corresponding bibliographic description in the repository

Publisher copyright

(Article begins on next page)

Beam Scanning Reflectarrays for DTH application: preliminary results

P. Pirinoli¹, T. Lohrey², M. Orefice^{1,3}, M. Beccaria¹, G. Dassano¹

¹ DET- LACE, Politecnico di Torino, Italy, email: {paola.pirinoli;michele.beccaria;gianluca.dassano}@polito.it*

² Eutelsat S.A., Paris, France, email: tlohrey@eutelsat.com, tlohrey@gmx.net

³ IEIIT- CNR, Politecnico di Torino, Italy, email: mario.orefice@ieiit.cnr.it

Abstract—In this paper, some preliminary results on the feasibility analysis and prototype tests of a Direct-To-Home (DTH) receiving antenna system based on the use of a planar Reflectarrays with beam scanning capabilities, are discussed.

Index Terms—DTH antenna system, Reflectarray, Scanning beam.

I. INTRODUCTION

Most of the receiving antennas for Direct-To-Home (DTH) satellite transmissions consist of an offset parabolic reflector; sometimes they are substituted by a planar array that has a lower volume, but it presents the drawback of high losses and reduced efficiency due to the need of a Beam Forming Network (BFN) to connect the elements to the receiver. Both these types of antenna must be mounted externally to the building; the complete antenna needs to be pointed to the direction of arrival of the signal, so that it requires a strong fixation mast, and an azimuth/elevation mount that often may have a significant visual impact, that may be not acceptable in some cases (e.g. in historical centers or buildings).

To overcome this limitation, a new DTH antenna configuration, based on the use of a planar Reflectarray (RA), is here considered. Taking advantage from the intrinsic nature of a RA, in which the direction of maximum radiation can be controlled by properly arranging the phase distribution provided by the re-radiating elements, it is possible to guarantee that the planar reflector is always mounted parallel to a wall of the building, with only the arm supporting the feed protruding from it. A fixed and relatively small number of reflectarrays could be designed, each covering a predefined angular region both in elevation and in azimuth; inside each of these ranges, the fine pointing is obtained scanning the beam by adjusting properly the position of the feed.

In fact, the possible techniques that are generally adopted for obtaining the beam scanning with a reflectarray can be roughly grouped in two categories, differing for using an active or a passive planar reflector. In the first case, the phase that each unit-cell provides is not obtained controlling its geometrical parameters, but through the introduction of electronically tunable elements as diodes or MEMS (see e.g. [1]): in this way, it is possible to obtain good scan

capabilities, but at the cost of the increasing of the antenna complexity.

In the configurations using a passive RA, the beam scanning is obtained changing the spatial delay between the feed and the planar reflector itself, that is equivalent to change the field phase distribution on the reflectarray surface. This effect could be simply obtained properly moving the feed, if it consists in a single radiating element, or using a feed arrays. However, when the reflectarray is designed to behave as a parabolic reflector, as in the conventional cases, the scanning capabilities of the resulting antenna system are poor. For this reason, several alternative solutions have been presented, based on the idea that the RA does not simulate a parabola. In [2], [3] a bifocal reflectarray, using a single reflecting surfaces or a main and a planar sub-reflector, shows improved results. Other authors investigate the possibility of designing reflectarrays emulating a parabolic cylinder [4], a parabolic torus [5] or a spherical reflector [6]. The preliminary numerical results collected in [4]-[6] are promising, even if the presented antenna systems have all the disadvantage of requiring a large planar aperture, that is partially illuminated in correspondence of each position of the feed or each feed array configuration. Moreover, only the antenna simulating the spherical reflector allows a bi-dimensional scanning.

In view of the application of interest here, the planar reflector area and the ratio F/D , where F is the distance between the feed and the RA plane and D the largest side of the planar reflector, must be comparable with the corresponding quantities for the parabola: therefore, the solutions proposed in [4]-[6] are not much applicable.

In Sect. II the main requirements that the antenna system must satisfy are discussed, while in Sect. III the basic concepts of the RA design procedure introduced here are summarized; finally, in Sect. IV preliminary numerical and experimental results are presented.

II. ANTENNA SYSTEM DEFINITION

The final antenna system aims to replace and compete with existing parabolic antennas and need to fulfill a number of specifications, described in the following.

A. General considerations

The antenna shall be as “invisible” as possible, and the reflectarray shall be flat at the supporting wall: consequently, there will be no fixation mast or azimuth elevation mount required. The reflectarray shall be able to be painted to match the color of the supporting wall, so that the reflectarray is quasi invisible. This brings the problem that the supporting wall is most likely vertical and not necessarily in direction of the satellite. Simulations and practical tests have shown that the feed arm can be moved about $\pm 7.5^\circ$ in elevation and $\pm 15^\circ$ – 17° in azimuth without significant degradation of the received signal quality from the satellite.

Figure 1 shows the elevation angles for geostationary satellites in Europe and North Africa reaching from 10° up to 55° depending on the geographic location. This range can be roughly divided in three sub-ranges, each one covered by a different RA: a first range may cover from 10° to 25° , a second from 25° up to 40° , while a third one stretches from 40° up to 55° . In azimuth, the situation is similar: the beam steering depends on the angle of the supporting wall towards the desired satellite, and therefore three different RA antenna configurations must be designed to cover the entire azimuth range of $\pm 50^\circ$, each one covering approximately 34° . A sketch of the relative positions between the satellite and the reflectarray, with an indication of the range covered by each configuration, is shown in Fig. 2.

In total, this distinction between different elevation and azimuth ranges will lead to maximum 9 different RA designs depending in elevation by the geographical location and in azimuth by the direction of the supporting wall towards the satellite. The feed arm with the LNB is fixed at the reflectarray attached to the wall with a ball joint or other means that will allow their movement in elevation, azimuth and in polarization, for the precise fine pointing to the desired satellite. The lightweight LNB and feed arm will be the only visible elements of the whole satellite antenna.

B. Multi-feed aspects

Conventional parabolic DTH antennas, often equipped with several LNBS, allow simultaneous reception from satellites at different orbital positions. While classical flat panel antennas do not allow this option, with the reflectarray solution a multi-feed reception is possible in a similar way than with parabolic antennas.

C. Commercial aspects

In the competitive price driven market of DTH antennas the reflectarray antenna raw cost shall not be more than twice as expensive as a good conventional parabolic reflector antenna.

The biggest cost driver is the reflectarray PCB itself, however in mass production the array may consist either of a multi-layer PCB or of a sandwich construction consisting of a thin aluminum layer glued to a stable foam layer and on a plastic printed copper patches. Both technologies allow low cost mass production.

The analysis and comparison of the different elements of a conventional reflector and this antenna gives the following picture:

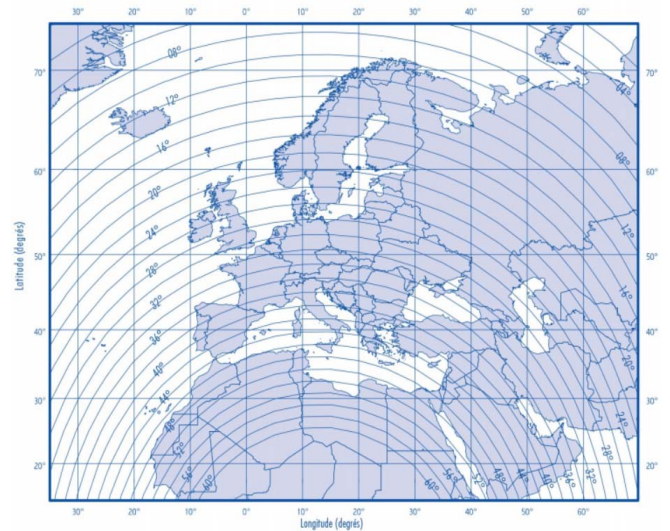

Fig. 1. Elevation angles for Eutelsat 13° position.

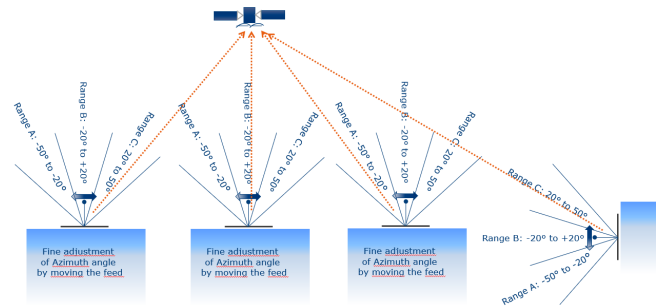

Fig. 2. Different azimuth angles and configurations.

- Reflectarray versus steel stamped parabolic reflector of comparable size: reflectarray is expected to be significantly more expensive.
- Azimuth – elevation mount and antenna fixation: this has about the same price than the steel stamped reflector if not more, while this cost does not exist for the fixed wall mounted reflectarray antenna.
- Ball joint feed arm and LNB compared to a fixed feed arm and LNB: it is more expensive, but the part of the antenna cost is not that significant. In total, it appears reasonable that the antenna will arrive at a production price below twice the price of a conventional parabolic antenna.

III. REFLECTARRAY DESIGN PROCEDURE

Even if the scanning ranges are not very large, the antenna has to provide it in both azimuth and elevation. Moreover, considering the requirement on the antenna size and that the initial position of the feed is already offset, the design of such a reflectarray is a challenging issue. In view of that, a convenient solution is to realize a RA emulating a spherical reflector [6], but keeping its size reduced, so that the reflecting surface is used entirely for each position of the feed. The phase distribution is therefore designed so that each element of the RA provides a phase ϕ_{mn} that compensates the path difference $d_{s,mm}$ between the planar and the spherical reflector (see Fig. 3).

It is well-known that in a spherical reflector the beam scanning is obtained by moving the feed along a circular arc, with the center coincident with that of the spherical surface, and keeping its aperture tangent to the arc itself. In this way, the field radiated by the feed illuminates different portions of the spherical aperture when the feed itself moves and this requires the use of a larger aperture. To avoid this limitation, here the following solutions have been adopted:

- the feed is still moving along an arc in azimuth, while in elevation, due to the required small scanning angle, it moves along a straight line (see Fig. 3);
- the orientation of the feed is kept constant, as shown in Fig. 3; in this way, properly selecting the position of the feed (keeping in mind that it also must be optimized to avoid the spherical aberration [7]), and its starting direction of pointing, it is possible to illuminate adequately the reflectarray aperture.

IV. PRELIMINARY RESULTS

To validate the procedure described above, a first prototype has been designed, manufactured, numerically and experimentally characterized. The planar reflector has a size of about 73 cm x 61 cm (in accordance with the specs described in Sect. II) and it is discretized by 85x71 square patches, printed on a FR4 dielectric substrate characterized by thickness $h = 1.55$ mm, $\epsilon_r = 3.9$ and $\tan\delta = 0.019$. At the design frequency of 11.725 GHz, the size of the RA unit cell is therefore equal to $\lambda/3$. In Fig. 4 the variation of the phase of the reflected field as a function of the side W of the patch and for several angles of incidence, is represented. In the inset, the unit cell is also shown.

For what concerns the position of the feed, this has been optimized following the guidelines introduced in Sect. III and the antenna requirements in Sect. II.

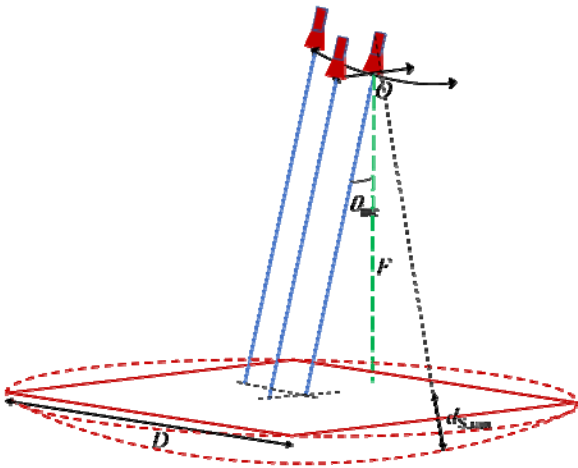

Fig. 3. Geometry of the reflectarray with the spherical surface whose behavior is emulated.

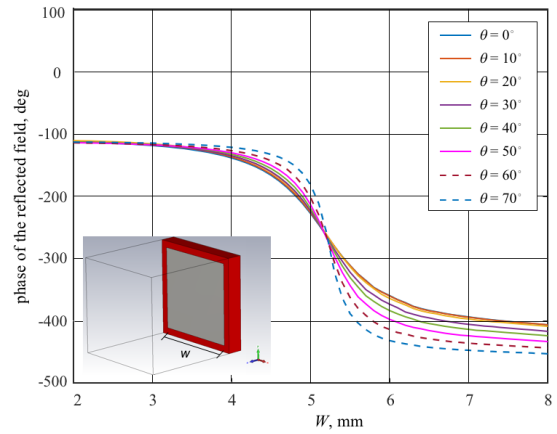

Fig. 4. Variation of the phase of the reflected field as a function of the side of the re-radiating element, computed for different values of the angle of incidence. Inset: unit cell.

The configuration covering the angular range $[25^\circ, 40^\circ]$ in the elevation plane has been considered. In the azimuth plane the steering must be at least between -15° and $+15^\circ$. Taking also into account the specs on F/D, the central position of the feed has a distance from the RA surface that corresponds to have $F/D = 0.55$, and from the lower border of the reflectarray of 15.3 cm. The angle of incidence of the feed axis is $\theta_{inc} = 20^\circ$, and this means that a further angular tilt of approximately 13° has to be provided by the radiating elements to have the direction of maximum radiation in the elevation plane of 33° , that is the central value of the range of interest.

To validate the adopted design procedure, a first prototype has been designed, numerically analyzed, manufactured and experimentally characterized (Fig. 5).

Simulations have been carried out for 6 different feed positions (indicated from A to F), to find the patterns and the beam pointing directions. Fig. 6 shows the various positions of the feed in the quasi-focal plane, and the direction of the beams vs. the azimuth-elevation angles. It can be seen that there is a good correspondence between the vertical/horizontal displacement of the feed and the elevation/azimuth steering of the beam, reaching values of $\pm 7.5^\circ$ and more than $\pm 20^\circ$, respectively.



Fig. 5. Reflectarray prototype.

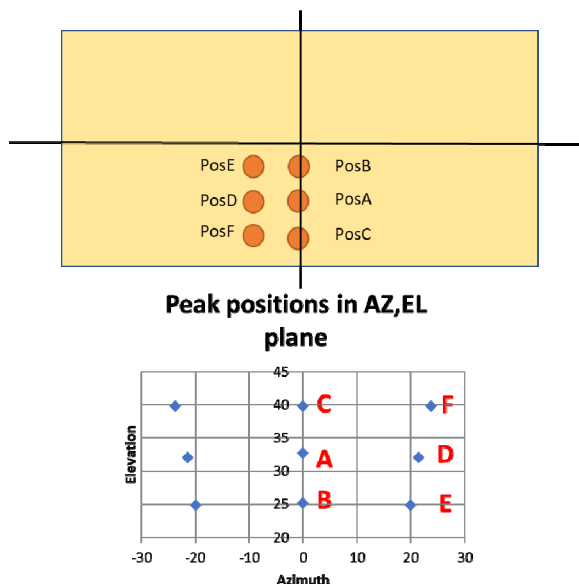

Fig. 6. Feed positions in the vertical plane and corresponding beam peak directions.

Among the first experimental results obtained, of particular interest is the direct comparative measurement with a high quality 65 cm parabolic antenna. The prototype was equipped with a ball joint fixed LNB, mounted on a vertical wall in cloudy weather conditions at the Eutelsat teleport close to Paris. All measurements were done over Eutelsat Hot Bird satellite and covered the frequency band from 10.95 GHz up to 12.75 GHz in horizontal and vertical polarization.

Figure 7 and 8 show the MER and the C/N of the measurement of a selection of DVB carriers throughout the entire frequency band and for both polarizations.

The results show that the reflectarray antenna works well although it is limited in the frequency range, because it has been realized using square patches that are characterized by a reduced frequency band; here, however, the aim was just that of testing the feasibility of the antenna and its scanning capabilities, while further developments focused on the optimization of the re-radiating element geometry to allow for a wider frequency band is in progress.

As the diagrams in Figs. 7 and 8 show, the performances of the reflectarray antenna at the design frequency are as good as those of the parabolic antenna.

ACKNOWLEDGMENT

This work has been funded by Eutelsat S.A. in the framework of the project “Planar Reflectarrays for DTH antenna use”.

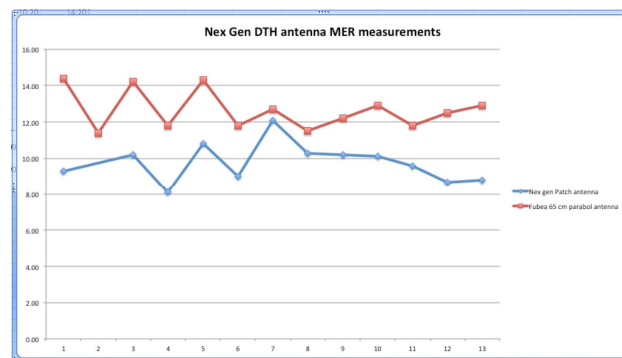

Fig. 7. MER of a selection of DVB carriers.

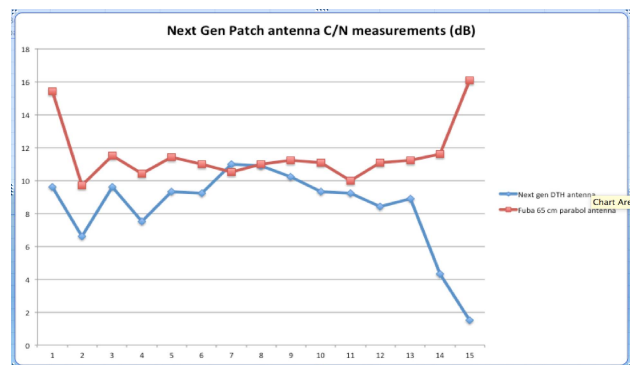

Fig. 8. C/N of a selection of DVB carriers.

REFERENCES

- [1] S. V. Hum and J. Perruisseau-Carrier, “Reconfigurable Reflectarrays and Array Lenses for Dynamic Antenna Beam Control: A Review,” *IEEE Trans. Antennas Propag.*, vol. 62, no. 1, pp. 183-198, Jan. 2014.
- [2] P. Nayeri, F. Yang and A. Z. Elsherbeni, “Bifocal Design and Aperture Phase Optimizations of Reflectarray Antennas for Wide-Angle Beam Scanning Performance,” *IEEE Trans. Antennas Propag.*, vol. 61, no. 9, pp. 4588-4597, Sept. 2013.
- [3] E. Martinez-de-Rioja, J. A. Encinar, A. G. Pino, B. Gonzalez-Valdes, S. V. Hum and C. Tienda Herrero, “Bifocal Design Procedure for Dual-Reflectarray Antennas in Offset Configurations,” *IEEE Antennas and Wireless Propag. Letters*, vol. 17, no. 8, pp. 1421-1425, Aug. 2018.
- [4] F. Guo, Y. Mao, S. Xu, F. Yang and A. Z. Elsherbeni, “A modified parabolic-cylindrical reflectarray antenna for wide beam scanning capability,” *2014 IEEE Antennas and Propag. Society Int. Symposium (APSURSI)*, Memphis, TN, 2014, pp. 1023-1024.
- [5] P. Nayeri, F. Yang and A. Z. Elsherbeni, “Offset parabolic-torus-phase reflectarray antenna,” *2014 IEEE Antennas and Propag. Society Int. Symposium (APSURSI)*, Memphis, TN, 2014, pp. 1025-1026.
- [6] P. Nayeri, F. Yang and A. Z. Elsherbeni, “Studies on planar reflectarrays with spherical-phase distribution for 2-D beam-scanning,” *2013 IEEE Antennas and Propag. Society Int Symposium (APSURSI)*, Orlando, FL, 2013, pp. 1670-1671.
- [7] T. Li, “A study of spherical reflectors as wide-angle scanning antennas,” *IEEE Trans. Antennas Propag.*, vol. AP-7, no. 3, pp. 223-226, Jul. 1959.