

An Optical Sampling System for Distributed Atmospheric Particulate Matter

*Original*

An Optical Sampling System for Distributed Atmospheric Particulate Matter / Lombardo, Luca; Parvis, Marco; Angelini, Emma; Grassini, Sabrina. - In: IEEE TRANSACTIONS ON INSTRUMENTATION AND MEASUREMENT. - ISSN 0018-9456. - STAMPA. - 68:7(2019), pp. 2396-2403. [10.1109/TIM.2019.2890885]

*Availability:*

This version is available at: 11583/2735335 since: 2020-02-13T17:21:22Z

*Publisher:*

IEEE

*Published*

DOI:10.1109/TIM.2019.2890885

*Terms of use:*

This article is made available under terms and conditions as specified in the corresponding bibliographic description in the repository

*Publisher copyright*

IEEE postprint/Author's Accepted Manuscript

©2019 IEEE. Personal use of this material is permitted. Permission from IEEE must be obtained for all other uses, in any current or future media, including reprinting/republishing this material for advertising or promotional purposes, creating new collecting works, for resale or lists, or reuse of any copyrighted component of this work in other works.

(Article begins on next page)

© 2019 IEEE. Personal use of this material is permitted. Permission from IEEE must be obtained for all other uses, in any current or future media, including reprinting/republishing this material for advertising or promotional purposes, creating new collective works, for resale or redistribution to servers or lists, or reuse of any copyrighted component of this work in other works.

*Title: An optical sampling system for distributed atmospheric particulate matter*

*Authors:*

*Luca Lombardo*

*Dipartimento di Elettronica e Telecomunicazioni, Politecnico di Torino, Torino, Italy*

*Marco Parvis*

*Dipartimento di Elettronica e Telecomunicazioni, Politecnico di Torino, Torino, Italy*

*Emma Angelini*

*Dipartimento di Scienza Applicata e Tecnologia, Politecnico di Torino, Torino, Italy*

*Sabrina Grassini*

*Dipartimento di Scienza Applicata e Tecnologia, Politecnico di Torino, Torino, Italy*

DOI: 10.1109/TIM.2019.2890885

# An Optical Sampling System for Distributed Atmospheric Particulate Matter

Luca Lombardo, *Student Member, IEEE*, Marco Parvis, *Fellow, IEEE*,  
Emma Angelini and Sabrina Grassini, *Senior Member, IEEE*

**Abstract**—The atmospheric particulate matter is considered one of the most dangerous pollutants because of its effects on the climate and human health. Particulate concentration changes largely with spatial position and time, thus a distributed real-time monitoring would be mandatory, especially in densely populated areas. The proposed optical sampling system has a negligible cost with respect to the already available instruments and can be used for deploying a capillary particulate monitoring network thanks to its wireless capability based on the LoRa protocol. The proposed solution employs an optical method for the atmospheric particulate detection and the estimation of its concentration and size distribution. The air is sampled by a small pump which forces a known flux through a commercial glass-fiber filter where particulate is captured. A low-cost digital camera coupled with a multi-wavelength lighting system takes periodically photos of the filter surface and a small PC-on-Single-Board processes the acquired images in order to identify the particles and to estimate their size. The system can work unattended for long time and transmit remotely measurement data with a typical range of few kilometers.

**Index Terms**—Human health, Distributed Particulate Measurement, Environmental monitoring, Air pollution

## I. INTRODUCTION

The atmospheric particulate matter is an heterogeneous aerosol of fine particles (from few nanometers to several tens of micrometers) originated by different sources and mainly composed of inorganic salts, mineral dusts and organic compounds [1]. The properties of these particles (size, chemical composition, morphology, reactivity, etc.) change significantly according to their origin that can be natural (erosion, seawater spray, volcanic activities, etc.) or anthropogenic (mainly industrial activities and combustion of biomass and fossil fuels). Furthermore, part of this primary particulate reacts chemically and/or mechanically to generate secondary particles through processes that have not been till now fully investigated.

Main problems concerning the atmospheric particulate matter are its severe effects on human health and climate, so that particulate is nowadays considered one of the most dangerous pollutants.

Particulate affects climate both on a local and global scale including direct effects, like the filtering of solar radiation, and indirect effects, like changing the nucleation processes of clouds and their reflectance. Moreover particulate, especially the organic one, is considered one of the main responsible for the rainwater acidification.

L. Lombardo, M. Parvis are with the Department of Electronics and Telecommunications, Politecnico di Torino, Italy.

S. Grassini, E. Angelini are with the Department of Applied Science and Technologies, Politecnico di Torino, Italy.

In addition, particulate has many dangerous effects on the human health. Some of the most toxic and carcinogenic compounds, such as polycyclic aromatic hydrocarbons and polychlorinated biphenyls, have been detected in the atmospheric particulate matter originated by industrial production and biomass burning. Atmospheric particulate, after direct inhalation by humans, enters the first respiratory system producing allergies, inflammations and a transitory reduction of breath capability. Finest particles, with dimension smaller than  $2.5 \mu\text{m}$ , can enter and deposit inside the secondary respiratory system (bronchi, alveoli) generating severe respiratory diseases like chronic asthma, emphysema and lung cancer [2,3]. Moreover, toxic compounds can directly pass from the alveoli to the blood stream creating global intoxication, cancer and cardiovascular diseases [4]. The World Health Organization (WHO) has estimated in about two millions the deaths due to atmospheric particulate pollution [5,6].

Particulate effects greatly depend on particle chemical composition and morphology, so that an extensive and reliable characterization of its properties and spatial distribution is mandatory for assessing the health hazard due to a long-term exposition, especially in densely populated areas. In particular, spatial distribution is strongly dependent on local weather, ventilation, and it can change quickly in time. Currently available measuring systems, briefly described in section II, are bulky, expensive, and often not suitable for real time measurements. For these reasons, it is very important to develop an architecture suitable for a real-time particulate monitoring featuring low-cost measurement nodes that can be easily and widely spread on the territory.

## II. PARTICULATE MEASUREMENTS AND THE PROPOSED OPTICAL SOLUTION

Atmospheric particulate matter is usually classified according to its equivalent aerodynamic size using the  $PM_{xx}$  scale, where  $xx$  is the equivalent diameter of the particle expressed in  $\mu\text{m}$ . A particle with an aerodynamic size of  $10 \mu\text{m}$  behaves as having the same inertial properties of a spheric particle with a diameter of  $10 \mu\text{m}$  and a density of  $1 \text{ kg/dm}^3$ . Thus, as an example, the  $PM_{10}$  particulate refers to the total amount of particles whose average equivalent size is equal or lower than  $10 \mu\text{m}$ . Many solutions are available to measure the particulate [7], however most standard sampling systems are typically designed to measure only specific particles sizes and are not able to provide detailed information of the particulate size distribution. In addition, they have a cost of several

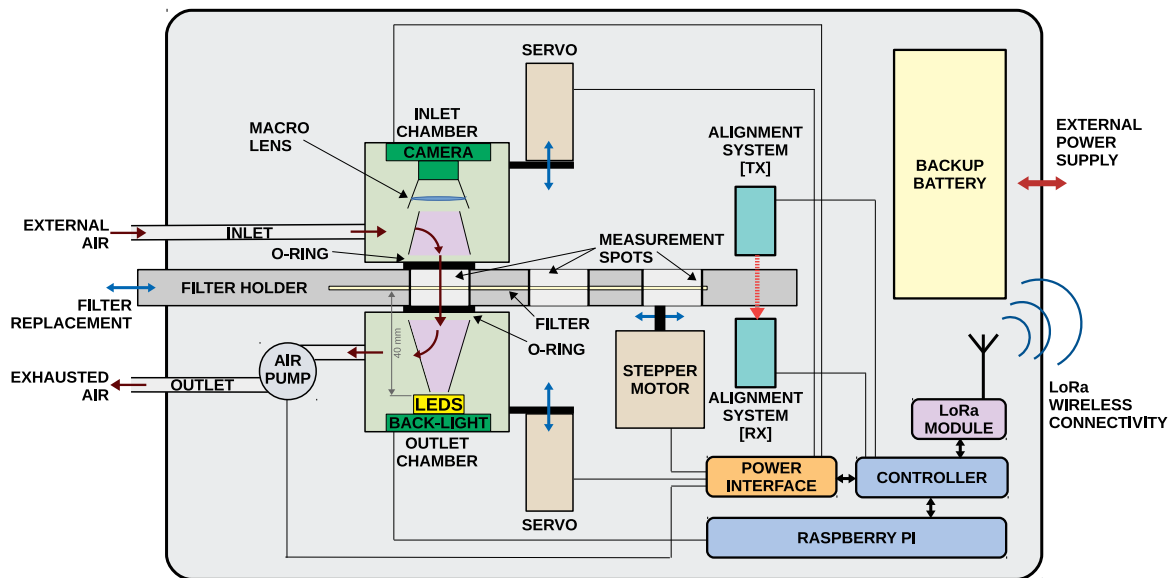

Fig. 1. Block diagram of the sampling system measuring node based on a RaspberryPI Zero W, a microcontroller, and a LoRa transmitter.

thousands dollars, which prevents using them for measuring the particulate concentration in many different points.

Available instruments typically employ either a gravimetric method for the estimation of particulate concentration or an optical one often based on light scattering. In the gravimetric method, particles are separated by dimension using special sizing filters (cyclonic separators and impactors). Particles of the selected size range are then captured onto a filter. The filter weight change and the total air flux knowledge allows one to calculate the particulate concentration which is typically expressed in  $\mu\text{g}/\text{m}^3$ . These systems usually have large dimensions, are expensive, and provide only a partial information on the size distribution of the particles; moreover they are not able to provide measurements in real-time. Optical systems based on laser scattering and absorption are instead suitable for real time measurements and rely on the light scattered and/or adsorbed by the particulate particles. Some of these systems are suitable for detecting at the same time different particle dimensions separating them in different counts (i.e. PM10 and PM2.5, as an example), but also their cost and size is definitely not negligible. Other, more expensive, particulate sensors exploit different methods [2,8,9], but generally they are not either able to provide the particle size distribution or are able to work only on a reduced size range [10].

The proposed sampling system instead employs a different approach with the goal to provide real-time measurement of the atmospheric particulate matter concentration and size distribution. The developed sampling system is cheap and small in size, and is able to connect wireless using the LoRa protocol [11] in order to easily deploy a long-range monitoring network for a distributed particulate monitoring.

Fig. 1 shows the block diagram of the proposed optical system. The external air whose particulate content has to be measured enters the instrument through an inlet tube, enters into the inlet chamber and crosses the filter where the particu-

late having dimension greater than the filter mesh is deposited. Then the exhausted air enters the outlet chamber where a pump sucks it and throws it outside through the outlet tube. By using this arrangement the pump deals only with clean air and there is no possibility of having the measurements altered due to some particulate sticking inside the pump.

A video camera is hosted inside the inlet chamber and equipped with a macro lens which allows one to have a pixel resolution lower than the filter mesh dimension. The camera looks at the filter and capture the light which passes through it so that the particles captured by the filter appear as dark spots. The filter is back-lighted by a set of LEDs, which are in the outlet chamber and provide a light whose main wavelength can be changed according to the used LED. The LED are positioned at about 4 cm from the filter and therefore they can be considered as spot light sources with uniform distribution so that the dark spots corresponding to the particles have a size which is minimally influenced by the LED position.

Two small servo motors are used to push the inlet and outlet chambers in contact with the filter holder. In this way the measured air is forced to go through the filter and no air leakage is expected. When the processing software detects that the pollution particles cover more than few percents of the available surface, the pump is stopped, the two servo retract the chamber closing holders and a stepper motor is used to move the filter holder exposing a brand new filter area. An optical alignment system is used to be sure that only the sensitive filter area is interested by the air so that it is possible to compute the air volume passed through the filter  $V_{air}$  as:

$$V_{air} = F_{pump} \cdot t \quad (1)$$

where  $V_{air}$  is the air volume through the filter in  $\text{m}^3$ ;  $F_{pump}$  is the pump volume per unit of time in  $\text{m}^3/\text{h}$ ; and  $t$  is the time in hours.

The images taken by the camera are sent to a Raspberry PI board and processed by means of the OpenCV library to identify the particles. The Raspberry PI is connected to a controller which drives the motors, drives the LEDs and also interfaces a LoRa module which provides the connectivity toward a receiver. In this way it is possible to send the particle distribution, which is only few bytes at a distance which is in excess of one kilometer.

By properly choosing the values for  $F_{pump}$ , of the exposed filter area  $A_f$ , of the image captured area  $A_m$  and of the interval of filter switch  $T_s$  as well as of the filter mesh, it is possible to tailor the system to have a suitable amount of measured particles and to have the filter reaching its saturation in the presence of a predefined amount of particulate.

The particle equivalent mass  $M_{pxx}$  is:

$$M_{pxx} = \gamma \frac{\pi}{6} \cdot PMxx^3 = \gamma V_{pxx} \quad (2)$$

$$V_{pxx} = \frac{\pi}{6} \cdot PMxx^3 \quad (3)$$

where  $\gamma$  is the particle equivalent density usually assumed as  $1 \text{ kg/dm}^3$  and  $V_{pxx}$  is the particle volume.

The measured particulate expressed in  $\mu\text{g/m}^3$  is therefore:

$$P_{meas} = \frac{\sum_{PM_{min}}^{PM_{max}} M_{pxx} N_{pxx}}{V_{air}} \quad (4)$$

where  $M_{pxx}$  is the the equivalent mass of a particle of a specific size and  $N_{pxx}$  is the number of particles of that size.

Eq. 4 can be used to estimate the number of particles which go on the filter. As an example, if a specific  $PMxx$  is assumed to be largely prevalent, the expected number of particles  $N_p$  on the filter is:

$$N_p = \frac{P_{meas}}{M_{pxx}} \quad (5)$$

Eventually, the camera resolution in pixels  $C_{px}$  and  $C_{py}$  and in  $\mu\text{m}$   $C_\mu$  defines the measured area  $A_m$ :

$$A_m = C_\mu^2 \cdot C_{px} \cdot C_{py} \quad (6)$$

### III. COMPONENT DESIGN

In the described prototype, the employed filter is a low-cost glass-fiber filter tape with a width of 3 cm, a thickness of  $350 \mu\text{m}$  and an average mesh size of  $3 \mu\text{m}$  (grade GF10). This filter allows one to capture particulate matter with sizes down to  $3 \mu\text{m}$  with an efficiency of about 95% and to easily cut the filter to fit the holder. However other types of filters, as an example with mesh capable of stopping particulate with size of  $1 \mu\text{m}$  or below can be easily employed. The filter is hosted by an holder composed by two parts for fixing the filter tape in the proper position, as explained in fig. 2A. The holder provides a mask with 7 measurement spots. Each of them can be used until the saturation of the filter is detected or for a specified time interval that can be selected by a software interface. Each spot consists in two circular holes which diameter is 1 cm ( $A_f \approx 0.78 \text{ cm}^2$ ). Only one hole at a time is fluxed with air and used to capture the particulate,

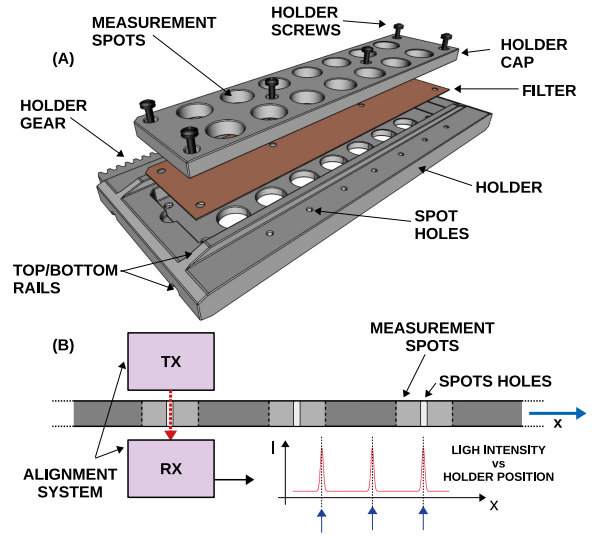

Fig. 2. The filter holder structure (A) and the working principle of the holder alignment system (B).

the other one can be optionally used to enable a differential measurement and reduce the filter mesh interference in the estimation of the particulate concentration. The holder has a linear gear which is used to periodically move the holder and change the measurement spot. Each measurement spot is provided with a small spot hole on its side. These holes are used by the holder alignment system to accurately align the sampling spots to the inlet and outlet chambers. Finally, two sets of guides are placed respectively on the top and bottom sides of the holder to keep its movement properly aligned.

A Raspberry PI NoIR Camera V2 has been selected for its low-cost and good performance. The camera features a resolution of 8 Mpx providing pictures of  $3280 \times 2464 \text{ px}$ . Furthermore, this type of camera does not have any IR filter, allowing one to take photo in an extended light bandwidth. The optical system has been designed to reach a resolution of  $2 \mu\text{m}$ , which is smaller than the filter mesh but large enough for using a low cost lens assembly. By using such a resolution it is achieved a measuring area of about  $1.6 \text{ mm} \times 1.6 \text{ mm}$  which, according to eqn. 6, corresponds to a measured area  $A_m$  of about  $2.56 \text{ mm}^2$  and a ratio  $A_m/A_f$  of about 0.033. The camera is directly interfaced to the Raspberry PI Zero using the Camera Serial Interface (CSI).

The back-lighting system employs 3 LEDs, one IR, one RGB and one UV, to provide the multi-wavelength lighting and to have the possibility of trying to discriminate between the different types of particulate. Since one of the three used LEDs is of RGB type, 5 wavelengths can be obtained:

- 880 nm, infra-red LED
- 625 nm, red (RGB LED)
- 528 nm, green (RGB LED)
- 470 nm, blue (RGB LED)
- 375 nm, ultra-violet LED.

Each LED can be controlled separately by the controller, and the LED lights can be optionally mixed together. Experimental measurements [12] put in evidence like spectral light

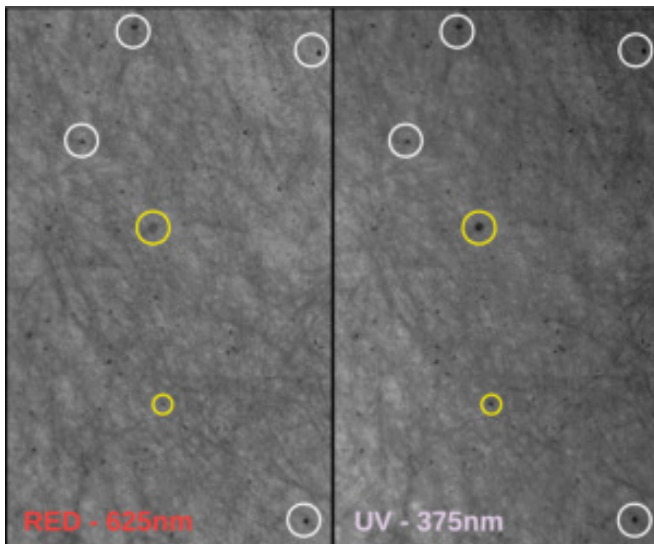

Fig. 3. Example of pictures taken with different wavelengths. The particles appear as having different levels of opacity and this might open the possibility of discriminating their composition. As an example particles marked in yellow appear having a high opacity to UV while they partially fade when the IR wavelength is used.

absorption of atmospheric particulate matter, especially the carbonaceous one, depends by its morphology and chemical composition opening the possibility of discriminating the particle nature. As an example, fig. 3 shows the same filter area acquired using the red back-lighting at 625 nm (A) and the UV one at 375 nm (B). It can be observed how the particles marked with yellow circles exhibit different transmissivity at the two wavelengths while the most of the other particles, for example the ones marked with white circles, does not exhibit any significant change. This would be an important point, which is quite difficult to assess at the moment due to a lack of a reference instrumentation, so that only the infra-red LED led has been used in the first tests, while other measurements are in progress to better investigate this possibility.

The pump generates a specified air flux  $F_{pump}$  and forces it through the sampling filter. This is a critical value to be chosen according to the specified amount of pollution which is expected to be measured and to the time interval before the filter is switched as it defines the actual air volume  $V_{air}$  (eqn. 1).

At the moment the authors decided to employ a switching time of one day ( $T_s = 24$  h) and to tune the system for measuring an average particulate of  $50 \mu\text{g}/\text{m}^3$  which is the alarm threshold in Italy so that a pump with a flux  $F_{pump} = 0.1$  L/min which can be increased to a maximum of  $F_{pump} = 0.5$  L/min was chosen.

With this pump the sampled air volume before switching the filter is of about  $V_{air} \approx 0.15$  m<sup>3</sup> which, according to eqn. 5 and considering only PM10 particles, corresponds to about 14000 particles. Since the ratio  $A_m/A_f$  is of about 0.033 the instrument should be required to measure a number of particles of the order of 470 with a filter coverage of the less than 2%.

In addition to these components the proposed system also

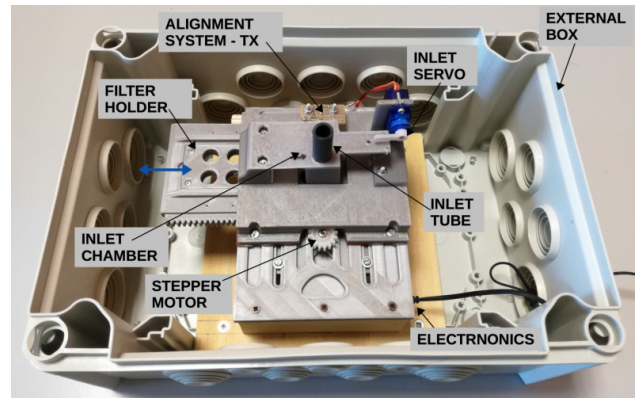

Fig. 4. The prototype of the sampling node, enclosed in its box, which has been employed in the measurement campaign.

provide:

- A RaspberryPI Zero W (RPI), which works as the main manager of the system performing all the high-level operations and processing the photo taken by the camera system. The Raspberry PI features a quite powerful 32-bit 1 GHz ARM microprocessor with 512 MB of RAM integrated in a small-factor board (65 mm × 30 mm). Moreover, it is provided with Bluetooth Low-Energy (BLE) and WiFi connectivity useful to connect the sampling system to the Internet and access it remotely. A lightweight linux distribution is installed on the RaspberryPI and the image processing is entirely performed on-board by the openCV library [13].
- A microcontroller, which has been added to the Raspberry PI in order to perform all the low-level real-time operations. An Arduino-compatible Teensy 3.2 board has been selected for its small size and computing capabilities (32 bit, 80 MHz). The controller directly interface the RX and TX of the alignment system and drives the stepper motor in order to precisely move the filter holder at each measurement spot. It also controls the two servo motors and the air pump using a dedicated power interface. Finally, it manages the back-lighting system by turning on/off the LEDs. The controller is connected to the RaspberryPI using a UART interface.
- A LoRa Wireless module RF-LORA-868-SO manufactured by RF Solutions, which enables the sampling system to operate using a long-range wireless connection with the LoRa protocol. This module permits to connect several sampling nodes creating a star network with a typical connection range of some kilometers. The module is connected to the microcontroller using the SPI interface.
- A rechargeable battery which can power the system from few hours to some days, according to its capacity. The battery is designed to avoid problems in case of a temporary blackout of the main supply, but can also be used for short measurement session in the absence of power supply.

Fig. 4 shows a prototype of the presented sampling system. All the mechanical parts of the sampling system have been

realized in PLA using a 3D printer. The system is enclosed in a water-proof box realized using an electrical derivation box available off-the-shelf.

This sampling system allows one to overcome some limitations of a previous system developed by the same authors [14]. In particular, the new system reduces the air leaks in the pumping using a dedicated clamping mechanism to seal the filter during air sampling. The mobile filter holder provides an improved masking and enables a differential measurement to be performed in order to further reduce the parasitic effects of the filter mesh and achieve an improved detection efficiency. Moreover, the filter holder allows an easy replacement of the sampling filter to be obtained, so that the maintenance of the system can be performed also by unskilled users without the necessity to open the system and operate on mechanical parts.

#### IV. THE MONITORING SYSTEM SOFTWARE

The software running on the sampling system is responsible for all the operations required by the application and can be classified in three different layers:

- The image processing software, which eventually computes the amount of particulate according to eqn. 4.
- The remote Internet interface.
- The real-time microcontroller firmware.

The Image Processing Software and the Remote Internet Interface have been inherited from a the previous version of the system and their details are described in [14], so only a short description is reported here.

##### A. The Image Processing Software

The Image Processing Software runs on the Rasperry PI and is responsible for interfacing the digital camera, taking periodically pictures of the filter surface and processing them in order to detect the captured particles, estimate their equivalent size and calculate the particulate concentration and the size distribution. The software uses the openCV library for the image processing and it is entirely written in the Python Language. The software performs a four step processing: steps 1 and 2 are used to acquire the image and prepare it for the identification process; step 3 is used to reduce the image irregularities and make it suitable for the subsequent process and eventually step 4 employs a freely available library to extract the particles.

- 1) A back-lighting wavelength is selected and the digital camera takes a picture of the filter surface. The possibility of changing the wavelength lets the system to get several images of the same area to discriminate the transparency of the different particle types with the final aim to discriminate among different types of pollutants. At the moment this capability is not exploited and only the red lighting is used. The camera is interfaced to the Rasperry PI zero using the PyCamera module.
- 2) The image is converted into gray scale mode, extracting one or more of the RGB channels according to the actual back-lighting wavelength. This operation lets the system to process the image without having to be worried about

the color changes and is used to optimize the camera response while reducing the noise contribution of not stimulated color channels.

- 3) A selective gaussian blurring is performed on the image to reduce the filter mesh effects on the particle identification; then a spatial filter is applied to the image in order to increase selectively its sharpness as described in [14].
- 4) The particles are detected and their size estimated by using the progressive threshold binary matching algorithm, already implemented in the openCV library, instead of more complex approaches [15,16] to speed up the processing, obtaining more than satisfactory results. One should note that in this operation there is the possibility more particles one close to the other are identified as single particles of greater size instead of being counted separately. This is an unavoidable problem connected to the imaging approach, which is similar to particle clustering in other optical solutions. Such a possibility increases as the filter coverage by the particles increases so that keeping low the maximum coverage, i.e. replacing the exposed area as the measurement starts increasing, reduces the problem.

##### B. The Remote Internet Interface

The monitoring system, taking advantage from the native WiFi support provided by the RasperryPI Zero, is able to directly connect to a WiFi Network. Thus, a Remote Internet Interface has been developed in the Python Language for running directly on the Rasperry PI in order to control remotely the system and have access to the measurement data.

In the current implementation the monitoring systems exposes a Graphical User Interface (GUI), where the user can remotely change the operating parameters for both manual and automatic operation, retrieve the system status and visualize last measurement data. All basic measurement parameters such as measurement time, back-lighting wavelength and filter change interval can easily changed remotely.

In the current implementation only a simple username/password security measure is used to avoid casual users to alter the monitoring system, but more safe operations can be easily conceived to avoid any data steal and spoofing.

##### C. The Real-Time Microcontroller Firmware

The microcontroller firmware has been completely re-designed with respect to the previously one described in [14] in order to accommodate the new filter changing system. Specifically, the firmware manages all the real-time operations required by the monitoring system:

- Holder stepper motor control and acquisition of the signals provided by the holder alignment system using one channel of the microcontroller ADC. In this way it is possible to perform the insertion/ejection of the holder and move it properly at each new measurement, as described in fig. 2.

- Inlet and outlet servo motor control to seal input and output chambers and avoid air leakages during a measurement.
- Pump control to generate the selected air flux.
- LED back-light control to generate the required wavelength.
- LoRa module interface and control using the SPI interface to manage the long-range connection.

The firmware has been developed using a Teensy 3.2 Board. The board, which is programmed by using the Arduino IDE, is interfaced to the RaspberryPI Zero using the UART interface.

## V. THE DISTRIBUTED MONITORING NETWORK

An atmospheric particulate monitoring network should be capable of measuring the particulate in several points on an area which could cover several square kilometers so that distance between nodes can easily be on the order of few kilometers.

While it could be possible to connect all nodes to a wired network, this would require deploying such a network and would prevent the installation of new nodes in locations where the network is not available. A wireless solution therefore would be much more suitable even though the large distances prevent some of the technologies to be used. A solution based on the cellular network is of course possible, but it would require a subscription with a cell phone provider for each of the nodes so that the authors decided to limit this solution to few concentrating nodes and to embed into each node a non-subscribing system.

Many wireless protocols are, nowadays, available for wireless communication [17]–[20], but most of them work only on short-range distances. Among the few protocols supporting a long-range transmission, there is the LoRa protocol [11], which is specifically designed for long-range ( $d_{max} \sim 10$  km) and low-power applications. Even though LoRa is a quite recent protocol, it is starting to be employed in many wireless application where long-range connectivity and moderate bit-rates are required [21,22]. Many modules supporting the LoRa protocol are actually available off-the-shelf; among them the authors have selected the RF-LORA-868-SO (from RF Solutions) for its low-cost and good performance both in terms of transmission range and power consumption.

The proposed network architecture is shown in fig. 5, where several autonomous sensing nodes are deployed on the territory. Few wireless receivers, possibly employing the cellular network to get access to the Internet, connect the nodes using the LoRa protocol in a star-network topology. The wireless receivers are connected to a dedicated cloud infrastructure through the Internet. The cloud allows authorized users to remotely configure the monitoring network and to access measurement data in real-time using dedicated PC or smart-phone clients.

## VI. EXPERIMENTAL RESULTS

In order to validate the proposed system, the authors performed several measurements of the atmospheric particulate matter concentration and size distribution in a location close

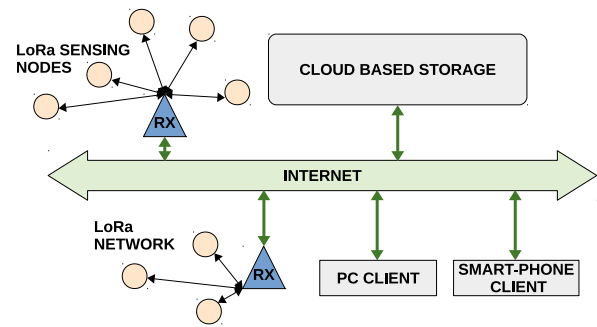

Fig. 5. Block diagram of the distributed monitoring network based on the LoRa protocol and a dedicated cloud infrastructure.

to the city of Caserta, in the South of Italy, by comparing the prototype results with a commercial particulate monitoring station based on the laser light-scattering measurement method.

To this aim a single complete prototype was arranged as described in the previous sections and a LoRa receiver was set-up to receive the data and to test the system connectivity.

The commercial monitoring system is able to provide, every 200 s, the concentrations of PM10, PM2.5 and PM1. Unfortunately, measuring particle concentration in a real environment is quite complex and comparative tests shown differences in commercial instruments of more than 20% [23,24]. The authors therefore assumed the same uncertainty level also for the laser light-scattering station which has the advantage of having the capability of discriminating the particle according to at least three sizes, and assumed such value as a initial target for the new proposed approach.

Some preliminary tests carried out with the commercial prototype revealed PM10 concentrations in the location of the order of  $4 \div 6 \mu\text{g}/\text{m}^3$  so that the authors decided to increase the air sampling flux of the proposed prototype to the maximum allowed value of  $F_{pump} = 0.5$  L/min in order to increase the number of captured particles per hour. The proposed prototype was programmed to sample the air changing the filter every 24 h, in order to have a daily measurement, while all data provided by the commercial station were recorded.

After one day, the exposed filter was analyzed with the Image Processing Software. Fig. 6A shows an example of the original image taken by the camera using the 625 nm wavelength. After image processing and particle identification, the software was able to identify the particles as shown in fig. 6B, where the identified particles are marked with a green circle whose diameter is the estimated particle size.

In this example the measured particle size distribution, reported in fig. 7, has a peak of concentration centered at  $8 \mu\text{m}$  and a total of 116 particles are detected. Of these, 72 particles have a size equal or below  $10 \mu\text{m}$  therefore being classified as PM10.

The total weight of these particles computed by the processing software, is  $0.0165 \mu\text{g}/\text{day}$ . The particles are deposited over the area  $A_m = 2.56 \text{ mm}^2$  for a total air volume of  $V_{air} = 0.72 \text{ m}^3/\text{day}$  which crosses a filter area of  $78 \text{ mm}^2$ . Thus, the PM10 average concentration over the selected day and

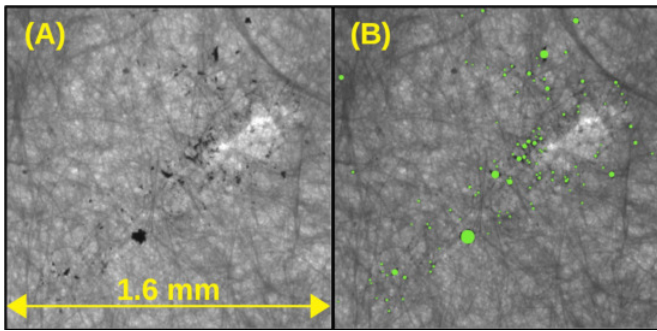

Fig. 6. A) Example of picture of the exposed filter taken by the camera using the 625 nm wavelength, B) particulate map created by the detection software.

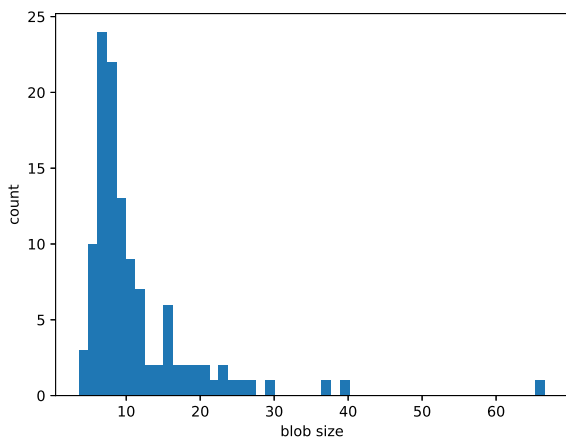

Fig. 7. Histogram reporting the particle size distribution as detected by the software. The peak of particle distribution is at a size of  $8 \mu\text{m}$ . Particles with size below  $3 \mu\text{m}$  are not stopped by the filter and therefore they do not appear in the histogram.

provided by the prototype is of about  $C_{PM10} = 0.36 \mu\text{g}/\text{m}^3$ .

Tab. I reports the average particulate concentration for PM10, PM2.5 and PM1 as measured by the commercial monitoring station in the same day.

TABLE I  
PARTICULATE CONCENTRATIONS IN PM10, PM2.5 AND PM1 PROVIDED BY THE COMMERCIAL MONITORING STATION.

$PM_{10}$	$PM_{2.5}$	$PM_1$	$PM_{10-2.5}$
$4.98 \mu\text{g}/\text{m}^3$	$4.83 \mu\text{g}/\text{m}^3$	$4.25 \mu\text{g}/\text{m}^3$	$0.15 \mu\text{g}/\text{m}^3$

From the table unfortunately it appears that most of the particles have a dimension below  $2.5 \mu\text{m}$ , a value that is not counted by the described prototype, which has a filter mesh of  $3 \mu\text{m}$ . A perfect matching between the results provided by the described prototype and by the commercial monitoring system is not possible, however a reasonable estimation of the measured particles can be obtained computing the difference  $PM_{10-2.5}$ . The obtained value is of the order of  $0.15 \mu\text{g}/\text{m}^3$ . Such a value is lower than the one provided by the described

system, but the values are comparable, even though the large uncertainty associated to the commercial monitoring system prevents making more detailed analyses, especially for such low amount of particulate. Anyway, the proposed system appears to be able to provide the particle size distribution with a cost that is at least one order of magnitude lower than the commercial devices.

## VII. CONCLUSIONS

Commercial systems currently available on the market are usually capable to measure atmospheric particulate matter only for fixed and well defined particle sizes. Optical systems can overcome this problem, but at the expense of a high uncertainty. Moreover, generally the available systems are quite expensive with a cost per unit often of more than 10K\$, and this prevents the possibility of arranging pervasive monitoring networks over large areas while the recorded values of the particulate matter change dramatically from point to point especially in densely populated areas.

The proposed solution is instead extremely cheap with a component cost of the order of 200\$ and is able to estimate the particulate size distribution in quasi real-time. It is also small and provides a wide range wireless connectivity: thanks to the embedded LoRa wireless protocol, it is easy to arrange an effective sensing network for particulate monitoring even on large scale, like cities or industrial areas featuring a very large number of sensing points.

Even though the development of the sampling system is still in progress, the first measurements carried out by comparing the prototype results with a commercial monitoring system look very promising and further measurements have been already scheduled for better evaluating the system performance also under heavier conditions.

From this point of view, the authors are working on a pumping system capable of increasing the air volume per minute which could be used in the case of very low particulate concentrations. Moreover, a filter with smaller mesh should be used to trap at least particles down to  $1 \mu\text{m}$ . Other hardware improvements are planned in order to reduce the overall size of the system and minimize the power consumption so that the proposed system could be deployed also in locations without a power supply.

The proposed solution based on a simple filter and on a video camera seems anyway a really cheap and powerful alternative to the commercial gravimetric and laser scatter systems, which can hardly be conceived for a capillary particulate monitoring in highly polluted areas. In addition, the LoRa connectivity, already tested on distances in excess of one kilometer, lets users to easily deploy a network sensor suitable to check the pollution concentration also in complex environments such as normal cities.

## VIII. ACKNOWLEDGMENT

The authors would to thank Prof. Carmine Lubritto of Università della Campania and Dott. A. Spagnuolo, Dott.ssa C. Vetromile e Dott. A. Masiello of the ENERGREENUP for the invaluable support and for the possibility of performing on-site measurements close to Caserta.

## REFERENCES

- [1] M. C. Jacobson, H. C. Hansson, K. J. Noone, R. J. Charlson, "Organic Atmospheric Aerosols: Review and State of the Science", *Reviews of Geophysics*, vol. 38, no. 2, pp. 267-294, 2000.
- [2] C. Chiang, "Design of a High-Sensitivity Ambient Particulate Matter 2.5 Particle Detector for Personal Exposure Monitoring Devices", *IEEE Sensors Journal*, Vol. PP, no.99, 2017, pp. 1-1
- [3] M. B. Marinov, S. Hensel, B. Ganev, G. Nikolov, "Performance evaluation of low-cost particulate matter sensors", 2017 XXVI International Scientific Conference Electronics (ET), 2017, pp- 1-4
- [4] C. A. Pope et al, "Cardiovascular mortality and exposure to airborne fine particulate matter and Cardiovascular mortality and exposure to airborne fine particulate matter and cigarette smoke shape", *Circulation*, 2009, 120:941-948
- [5] World Health Organization, "Health Effects of Particulate Matter", 2013 [http://www.euro.who.int/data/assets/pdf\\_file/0006/189051/Health-effects-of-particulate-matter-final-Eng.pdf](http://www.euro.who.int/data/assets/pdf_file/0006/189051/Health-effects-of-particulate-matter-final-Eng.pdf), last checked on November, 14 2017
- [6] World Health Organization, "Quantifying environmental health impacts", [http://www.who.int/quantifying\\_ehimpacts/news\\_events/en/](http://www.who.int/quantifying_ehimpacts/news_events/en/), last checked on November, 14 2017
- [7] S. Amaral et al "An Overview of Particulate Matter Measurement Instruments", *Atmosphere* vol. 6 pp. 1327-1345, 2006
- [8] R. M. Carter; Y. Yan "An instrumentation system using combined sensing strategies for online mass flow rate measurement and particle sizing", *IEEE Transactions on Instrumentation and Measurement*, Vol. 54, no. 4, 2005, pp. 1433-1437
- [9] R. M. Carter, Y. Yan, P. Lee "On-line Nonintrusive Measurement of Particle Size Distribution Through Digital Imaging", *IEEE Transactions on Instrumentation and Measurement*, Vol. 55, no. 6, 2006, pp. 2034-2038
- [10] X. Yu, Y. Zhi, B. Li, Q. Gong, Y. Xiao "Size spectrometry of environmental particulate matter using a nanofiber array", 2017 Conference on Lasers and Electro-Optics (CLEO), 2017, pp. 1-2
- [11] LoRaWAN(TM) What is it? freely available at [https://docs.wixstatic.com/ugd/eccc1a\\_ed71ea1cd969417493c74e4a13c55685.pdf](https://docs.wixstatic.com/ugd/eccc1a_ed71ea1cd969417493c74e4a13c55685.pdf)
- [12] T. C. Bond, R. W. Bergstrom, "Light absorption by carbonaceous particles: An investigative review", *Aerosol Sci. Technol.* 2006, 40, pag. 27-67
- [13] OpenCV library available at <https://opencv.org>, last checked on Dec. 5, 2017
- [14] L. Lombardo, M. Parvis, F. Vitiello, E. Angelini, S. Grassini, "A sensor Network for Particulate Distribution Estimation", 13<sup>th</sup> IEEE International Symposium on Medical Measurements and Applications, MeMeA 2018, pag. 1-6
- [15] J. Clark, M. Palmer, and P. Lawrence, "A transform method for the reconstruction of functions from nonuniformly spaced samples", *IEEE Trans. Acoust., Speech, Signal Process.*, vol. ASSP-33, no. 5, pp. 1151-1165, 1985.
- [16] G. Andria, F. Attivissimo, G. Cavone, A.M.L. Lanzolla "Acquisition Times in Magnetic Resonance Imaging: Optimization in Clinical Use", *IEEE Transactions on Instrumentation and Measurement* ISSN:0018-9456, vol. 58, no. 9, pp. 3140-3148, 2009.
- [17] E. Sisinni, A. Depari, A. Flammini, "Design and implementation of a wireless sensor network for temperature sensing in hostile environments", *Sensors and Actuators A: Physical*, January, 2016, Vol. 237, pp. 47-55, ISSN 0924-4247, DOI 10.1016/j.sna.2015.11.012.
- [18] L. Ascorti, S. Savazzi, G. Soatti, M. Nicoli, E. Sisinni, S. Galimberti, "A Wireless Cloud Network Platform for Industrial Process Automation: Critical Data Publishing and Distributed Sensing", *IEEE Trans. Instrumentation and Measurement*, February, 2017, Vol. 66, N. 4, pp. 592-603
- [19] L. Lombardo, S. Corbellini, M. Parvis, A. Elsayed, E. Angelini, S. Grassini, "Wireless Sensor Network for Distributed Environmental Monitoring", *IEEE Transactions on Instrumentation and Measurement*, Early access article, December 2017
- [20] S. Corbellini, E. Di Francia, S. Grassini, L. Iannucci, L. Lombardo, M. Parvis "Cloud based sensor network for environmental monitoring", *Measurement: Journal of the International Measurement Confederation*, Early access article, 2017
- [21] P. Ferrari; A. Flammini; M. Rizzi; E. Sisinni; M. Gidlund "On the evaluation of LoRaWAN virtual channels orthogonality for dense distributed systems", 2017 IEEE International Workshop on Measurement and Networking (M&N), 2017, pp. 1-6
- [22] A. Pötsch; F. Haslhofer "Practical limitations for deployment of LoRa gateways", 2017 IEEE International Workshop on Measurement and Networking (M&N), 2017 pp. 1-6
- [23] M. R. Heal "Intercomparison of Five PM10 monitoring devices and the implications for exposure measurement in epidemiological research", *Journal of Environmental Monitoring* Vol. 2 no.55, pp. 455-461, 2000
- [24] L. R. Criley et al "Evaluation of a low-cost optical particle counter (Alphasense OPC-N2) for ambient monitoring", *Atmospheric Measurement Techniques*, vol. 11 no. 2 , pp. 709-720, 2018

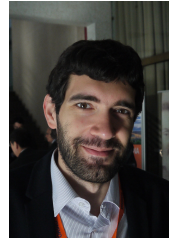

**Luca Lombardo** was born in Italy in 1986. He received his B.D. and M.S. degree in electronic engineering from the Università di Messina, Italy, in 2014 and 2016, respectively. Currently he is a PhD Student in Metrology with the Dipartimento di Elettronica e Telecomunicazioni, Politecnico di Torino. His research interests include the development of innovative sensors and systems especially for environmental monitoring and biomedical applications, embedded systems and instrumentation in general.



**Marco Parvis** was born in Italy in 1958. He received his MS degree in electrical engineering in 1982 from the Politecnico di Torino, Italy, and a Ph.D. degree in Metrology in 1987. He is now full professor of Electronic Measurements at the Politecnico di Torino, where he was Dean of the II Faculty of Engineering, and Fellow Member and chair of the TC 25 Medical Measurement of the IEEE Society on Instrumentation and Measurement. His main fields of interest are: intelligent instrumentation, application of signal processing to measurement, biomedical and chemical measurements. He is author of more than one hundred publications.



**Emma Angelini** was born in Torino in 1951, was graduated in Chemistry at Torino University. She is in Politecnico di Torino since 1976 and is now Full Professor of Applied Physical Chemistry in the Faculty of Engineering, Information Sector. Her research areas are: Corrosion and protection of metallic materials, as stainless steels, amorphous and nanocrystalline alloys, biomaterials for dentistry, tangible Cultural Heritage; plasma chemistry and coatings deposition. She is involved in National and European projects on corrosion and protection of metals and is member of the European Federation of Corrosion (EFC).



**Sabrina Grassini** was born in Italy in 1972. She received her M.S. degree in Chemistry in 1999 from the Università di Torino, Italy, and her Ph.D. degree in Metallurgical Engineering in 2004 from Politecnico di Torino, Italy. Currently she is associate professor of Applied Physical Chemistry with the Dipartimento di Scienza Applicata e Tecnologia, Politecnico di Torino. Her researcher areas include plasma chemistry, coating deposition, sensors, corrosion and protection of metallic materials, and conservation of cultural heritage.