

Influence of the patellar button thickness on the knee flexion after total knee arthroplasty

Original

Influence of the patellar button thickness on the knee flexion after total knee arthroplasty / Rosso, Ilaria; Surace, Cecilia; Antonaci, Paola; Surace, Filippo Maria; Negretto, René Joseph. - In: ACTA OF BIOENGINEERING AND BIOMECHANICS. - ISSN 1509-409X. - ELETTRONICO. - 20:4(2018), pp. 121-134. [10.5277/ABB-01163-2018-04]

Availability:

This version is available at: 11583/2727937 since: 2019-03-11T22:45:06Z

Publisher:

NLM (Medline)

Published

DOI:10.5277/ABB-01163-2018-04

Terms of use:

This article is made available under terms and conditions as specified in the corresponding bibliographic description in the repository

Publisher copyright

(Article begins on next page)

Influence of the patellar button thickness on the knee flexion after total knee arthroplasty

ILARIA ROSSO¹, CECILIA SURACE¹, PAOLA ANTONACI^{1*},
FILIPPO MARIA SURACE², RENÉ JOSEPH NEGRETTO²

¹ Laboratory of Bio-inspired Nanomechanics “Giuseppe Maria Pugno”, Department of Structural, Geotechnical and Building Engineering, Politecnico di Torino, Turin, Italy.

² Department of Othopaedics and Traumatology, Humanitas Gradenigo Hospital, Turin, Italy.

Purpose: One of the main problems of knee replacement is the limit of knee flexion. This study focuses on the knee implant and the patellar component currently in use in total knee arthroplasty, analyzing the influence of patellar thickness on the degree of knee flexion following surgery. *Methods:* A kinematics study was performed to evaluate whether an optimal patellar thickness can be identified, which enables the maximum flexion angle to be achieved. Using TC images, a healthy model was built. On this basis, a model of a knee joint which had undergone total knee arthroplasty using a *Legion PS* prosthesis was constructed. Initially, the standard thickness of patellar implant (9 mm) was used to build the model; then several different patellar implant thicknesses (in the range of 5–15 mm) were analyzed. *Results:* The results show a non-linear trend: a button thickness of less than 9 mm does not change the flexion angle, whereas a button thickness of over 9 mm results in a loss of flexion. The flexion loss is significant in the first two additions of thicknesses but negligible in the last ones. *Conclusions:* In the case studied, flexion reduction is not linearly proportional to the patellar thickness. The outcome of total knee arthroplasty is considered to be satisfactory with the standard patellar button. The results of this study could be used to compare the kinematics with other total prosthesis and patellar implants, and should enable the optimization of the patellar residue bone thickness to obtain deep flexion.

Key words: osteoarthritis, total knee arthroplasty, patellar button, flexion angle, modeling

1. Introduction

Interest in knee joints is growing in the biomedical and medicinal fields because of the high incidence of disease. In particular, not only elderly patients but increasingly also middle-aged people are suffering. When surgery cannot work in an optimal way, biomedical engineering is called upon to develop new technologies depending on the specific needs [19]. Today procedures are required to enable the patient to perform normal daily activities independently in the shortest recovery time possible [9].

Osteoarthritis is the main disease affecting patients who need a knee implant. It is a degenerative disease

that alters the articular cartilage and the underlying bone, resulting in pain, stiffness and limitation of movements. Rheumatoid arthritis is another cause of total knee arthroplasty. It is an inflammatory autoimmune disease which typically affects younger patients and differs from osteoarthritis in that it affects mainly the synovial membrane instead of the cartilage tissue. Surgery is also involved in the cases of osteonecrosis, the interruption of the blood supply that predisposes to severe secondary osteoarthritis.

Therefore, the aim of knee arthroplasty is to improve the quality of the patient's life by restoring autonomy and providing pain relief. However, the reconstructed articulation remains limited. Indeed, one of the main problems of knee replacement is the limit of knee flex-

* Corresponding author: Paola Antonaci, Laboratory of Bio-inspired Nanomechanics “Giuseppe Maria Pugno”, Department of Structural, Geotechnical and Building Engineering, Politecnico di Torino, Corso Duca degli Abruzzi, 24, 10129, Turin, Italy. Phone: +39-011-0904877, Fax +39-011-0904899, e-mail: paola.antonaci@polito.it

Received: July 15th, 2018

Accepted for publication: December 19th, 2018

ion. In general, humans need to perform daily activities with different flexion angles: 67° is necessary for the swing phase of gait, 83° for climbing up stairs, 90° for descending stairs, and 93° to rise from a chair. In North America and in Europe, flexion angles between 110° and 115° are generally acceptable. Instead in Asian and Islamic populations, deeper flexion is required to perform religious and cultural activities: e.g., up to 150° to squat and kneel [16].

Many studies focus on the identification of the factors that most influence the results of knee surgery, such as: the preoperative range of movement, patellar thickness, rehabilitation, prosthetic design, gender, age, diagnosis [4], [8], [9], [11]–[13], [16], [26]. Studies suggest that several of these parameters are involved in the flexion of the prosthetic knee, although other researchers propose the involvement of different parameters. This study focuses on innovating the knee implant and the patellar component currently in use in total knee arthroplasty, analyzing the influence of patellar thickness on the degree of knee flexion following surgery. Hence, a kinematics study is performed to evaluate whether an optimal prosthetic thickness can be identified, which enables the maximum flexion angle to be achieved.

2. Materials and methods

To carry out the analysis, two models were built: a healthy model and a prosthetic model. The following sub-sections include the description of the construction of the two models and the analysis conducted with the different thicknesses of the patellar component.

2.1. Ligaments model

In the model presented hereby, it is assumed that the ligaments are constituted by a single bundle of fibers anchored to a bone insertion point. Such a simplification with respect to reality (where ligaments are actually made up of several bands of tissue activated depending on the stress, not necessarily all together) is justified by the synergic work resulting from these bundles and is adopted in analogy with the biomechanical and experimental study validated by Abolghasemian et al. [2], where the ligaments are modelled as lines of constant length during the flexion.

Using the model only for kinematics analysis of the knee, since the main interest is the effective direction of the ligaments, their cross-section dimensions can be neglected. Furthermore, since only the linear elastic field is considered, a deformation within the values of the linear behaviour region of the stress-strain curve is considered acceptable. This way, the irreversible deformations that would damage the tissue are avoided.

In the simulations performed, the criterion used to establish the end of the flexion action is the reaching of the maximum patellar ligament elongation. From studies regarding the biomechanics of the ligaments, it has been established that the maximum elongation which can be applied to the patellar ligament is between 14% and 15% of its initial length [25]. These evaluations were performed considering a patellar preconditioning, for example, the preconditioning could include repeated cycles of flexion-extension that allow the elongation of the fibers through stretching exercises during a physiotherapy session.

The model used for each ligament represents a typical spring-damper system consisting of a linear spring

Table 1. Material properties and insertions of the ligaments used in the model

Ligaments	Stiffness [N/mm]	Damping coefficient [Ns/mm]	Insertions
ACL anterior fibres	83.15 [1]	–	From the inner face of the lateral femoral condyle to the front surface of the intercondylar eminence of the tibia
ACL posterior fibres	83.15 [1]	–	
ACL single bundle	166.3	0.5 [6]	
PCL anterior fibres	125 [1]	–	From the inner face of the lateral femoral condyle to the back surface of the intercondylar eminence of the tibia
PCL posterior fibres	60 [1]	–	
PCL single bundle	185	0.5 [6]	
MCL anterior fibres	91.25 [1]	–	From the medial epicondyle of the femur to the medial tibial portion
MCL oblique fibres	27.86 [1]	–	
MCL deep fibres	21.07 [1]	–	
MCL single bundle	140.18	0.5 [6]	
LCL	72.22 [1]	0.5 [6]	From the lateral epicondyle of the femur to the fibula head
LP	1200 [14], [20]	0.5 [6]	From the patellar apex to the anterior tibial tuberosity

and a damper arranged in parallel and fixed at one end corresponding to the bone insertion. The damping coefficient is selected as 0.5 Ns/mm [6] for all the ligaments, whereas the stiffnesses of the springs are all different and specified according to literature data [1], [14], [20] and the anatomy represented by the model. The patellar ligament stiffness is calculated as:

$$K = \frac{EA}{l}, \quad (1)$$

where E represents the Young's Modulus, A the ligament cross-section before the load application and l the ligament length at 0° flexion, all evaluated in the linear region of the stress-strain curve.

The stiffnesses of the ligaments considered are listed in Table 1.

The patellar ligament of the model measures 42 mm of length in extension, whereas the other parameters are taken from the literature [14], [23].

2.2. Quadriceps tendon model

In the same way as the ligaments, the quadriceps tendon is considered to consist of a single bundle, the line of action of which is set according to the anatomical bases. The insertion is selected to be on the superior pole of the patella. The Q angle is approximately 7° on the frontal plane, i.e., within the physiological range recorded in the literature [23].

The force generated by the tendon is not constant, but varies during flexion as demonstrated in experimental tests published in the literature [20], [28]: an increase of the flexion corresponds to an increase of the quadriceps force necessary to bring the knee again in extension.

2.3. Healthy knee model

The healthy knee model includes the femur, tibia, fibula and patella, patellar ligament, medial collateral ligament, lateral collateral ligament, anterior cruciate ligament and posterior cruciate ligament, and quadriceps tendon.

The geometrical models of the bones for the reconstruction of the knee joint are taken from the GrabCAD library [10] and enable the reproduction of both tibio-femoral and patellofemoral joints, whereas the bones are locked and cannot move relatively. These components were acquired in USA in 2014 from CT images of a left knee, then processed by Mimics [18] in order to highlight the bony contours from which the sur-

faces and the volumes were recreated. The articulation (in .igs format) is imported into SolidWorks [7] to create the volumes of the involved bones, to make bodies independent and, finally, to create mates in order to simulate the joint kinematics (Fig. 1).

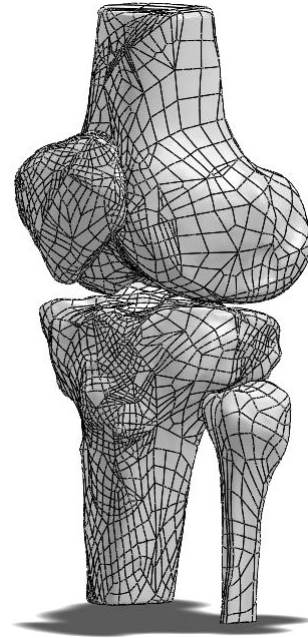

Fig. 1. Left knee joint model processed using Mimics from TC images available on GrabCAD and then imported into SolidWorks

As a preliminary analysis, the model anatomy is examined to check that there are neither malformations nor articular wear from advanced osteoarthritis, to ascertain that injuries are absent at the level of the femoral and tibial condyles and on the back surface of the patella.

In the sagittal plane, the articular surface of the tibia has a posterior slope of approx. 8° , included in the physiological range [23]. The patella is housed in a trochlear groove with a sulcus angle of 139° [21].

The bones, modelled as rigid bodies in SolidWorks, have no anatomical landmarks, anatomical axes nor anatomical plans, so it is necessary to identify these references. Therefore, the tibial mechanical axis, coinciding with its anatomical axis, and the femoral anatomical axis are drawn on the model of the bones, traced along the medullary cavity up to the center of the articular surface in a standing position.

The menisci are not included: in this study, the knee joint is not loaded by axial compression forces and the friction, which arises from the interaction with the bones, is considered to be low enough to be negligible [1]. Between the femur and the tibia, a distance of approx. 5 mm is fixed in extension to simulate the

thickness of the cartilage and the menisci. During the movement, the thickness of the soft tissue is always taken into account, although it is absent in the model.

Before the bone model components are joined together to reproduce the knee flexion, three reference planes are created separately for each one, namely the frontal plane, the sagittal plane and the transverse plane. In this way, working with axes and planes, it is possible to align the bones. As a first step, the bone model components are positioned in extension, i.e., the angle between the frontal plane of the femur and the frontal plane of the tibia is equal to 0° . Then, the femur is kept fixed while the tibia is left free to move: the angle between their frontal planes will measure the degree of knee flexion. The sagittal planes of the tibia and the femur, going respectively through the tibial mechanical axis and the femoral anatomical axis, are fixed relatively so as to achieve 7° in the frontal plane. This way the natural articular valgus is reproduced, which leads the femoral condyles lying on a transverse plane approximately parallel to the tibial plateau. The sagittal planes of the femur and the tibia

cannot change the angle between them during flexion. The latter constraint, which does not occur in reality, is justified by the necessity to provide a simplified model whose results could be more easily compared with other validated 2D models (e.g., [2]). The potential effects of this non-physiological assumption on the mechanical results of the model are partially balanced by the use of a femoral-tibial angle on the frontal plane as close as possible to reality and allowing to follow the anatomy of the condyles during the flexion arc, as detailed above.

2.3.1. Tibiofemoral joint

In the sagittal plane the tibial plateau follows the profile of the femoral condyles during the entire flexion and the kinematics of the tibiofemoral joint. This system may be reproduced by creating a constraint inspired by the motion of a “carriage” which is constrained to move along a track (the latter being referred to as “path” herein). Among the possible SolidWorks’ tools that create geometric relationships between assembly com-

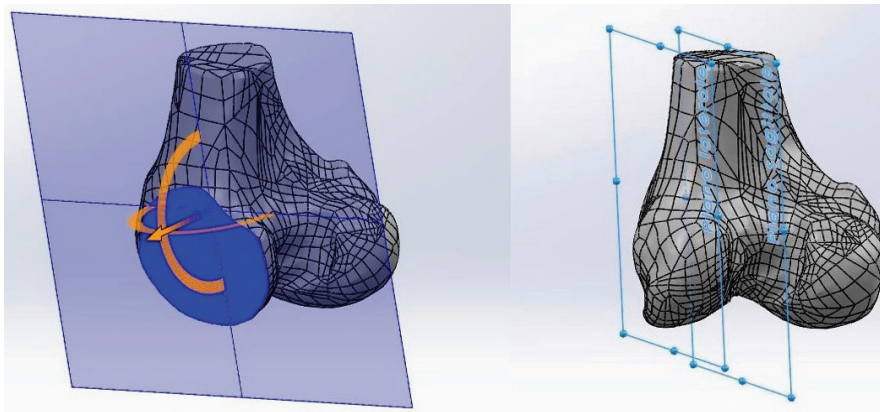

Fig. 2. Femoral component: the identification of the lateral plane where the condyle is more prominent (left), and its creation parallel to the sagittal plane at 25 mm from it (lateral-posterior view on the right)

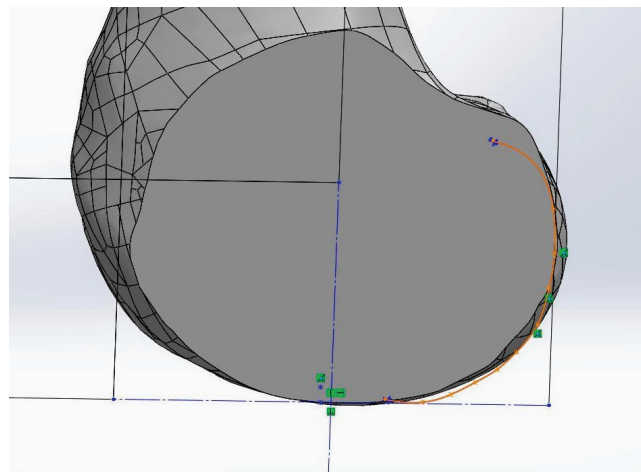

Fig. 3. Lateral view of the lateral femoral condyle: the path on the lateral femoral condyle is shown by an orange line

ponents, the “path mate” seems to be the most suitable for the purpose of the reconstruction of the knee kinematics.

The path is traced on the lateral profile of the femoral condyle using the “splines” function presented in the drawing tool. In order to use this function, a plane was created parallel to the sagittal plane and through a section where the lateral condyle of the femur is most prominent (in this study, the distance between the two planes was 25 mm), as shown in Figs. 2 and 3, illustrates the lateral view of the femur after the creation of the path. Tracing the path on the lateral condyle rather than on the medial condyle allows for a more uniform nearing of the femoral and tibial condyles during flexion. Furthermore, a greater compression on the lateral condyle, more extensive than the medial, is simulated at the end of flexion.

The “carriage” on the tibia must be on the same plane as the traced path being constrained to move along it. Consequently, a tibial plane is created which overlaps with the femoral plane (with distance from the sagittal plane also equal to 25 mm), as shown in Fig. 4.

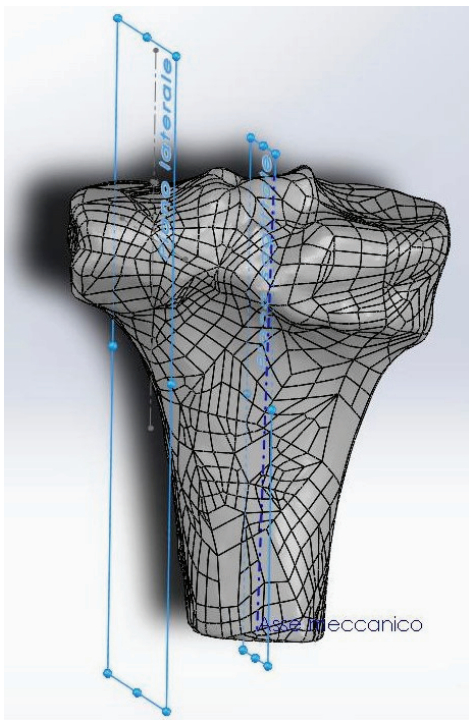

Fig. 4. Posterior view of the tibia: the light blue line represents the lateral plane, parallel to the sagittal plane and at a distance of 25 mm from it, such as the corresponding femoral planes. This allows the path on the femur to be constrained to the “carriage” on the tibia of the assembly

A segment was used to represent the “carriage” that slides on the femoral path. Indeed, a single con-

straint at a point does not allow the full control over the rotation of the tibia and the inclinations of the femoral and the tibial mechanical axes. The set length of the segment defines the control of the movement and the distance between the bones of the joint: if the chosen segment is too long (e.g., 10 mm) it results in the intersection of the bones’ volumes with deep flexion; (Fig. 5), if too short (e.g., 1 mm) it causes extreme displacement of the anterior tibial surface from the femur and a lateral distraction of the joint (Fig. 6).

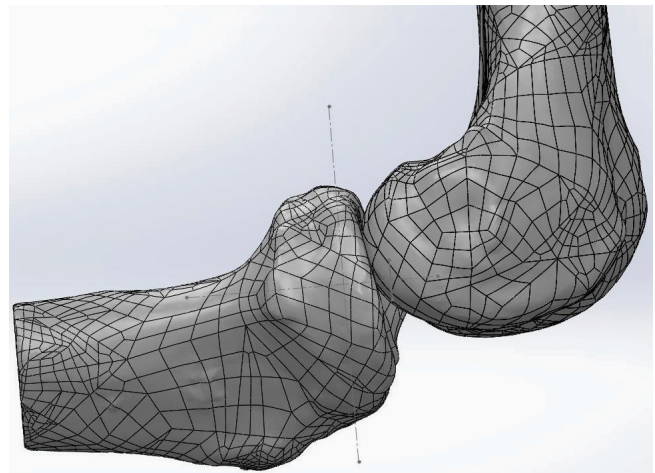

Fig. 5. Medial view of the tibiofemoral joint: note that too long a segment (“carriage”), for example 10 mm, causes the intersection of the bones’ medial volumes and an unreal compression of the cartilage

Simulations suggested that the most realistic segment length for this study is 4 mm (Fig. 7), as it ensures the correct reproduction of both rotation and anteroposterior translation, simulating knee rollback as shown in Fig. 8.

Within this model, the mediolateral translation and the rotation of the two bones around their own axes are neglected. The most significant restriction is ignoring the internal-external rotation, but from the results of a study by Bendjaballah et al. [3] it transpires that the effects can be neglected in a healthy knee considering overall displacements.

With this set of conditions, the maximal hyperextension allowed is 5° and the maximal flexion is 160° . The latter value is not realistic because the healthy joint cannot perform such a large flexion, being hampered by the tissues that are interposed and by the back contact of the shank with the thigh. Therefore, the maximum knee flexion is restricted to 145° .

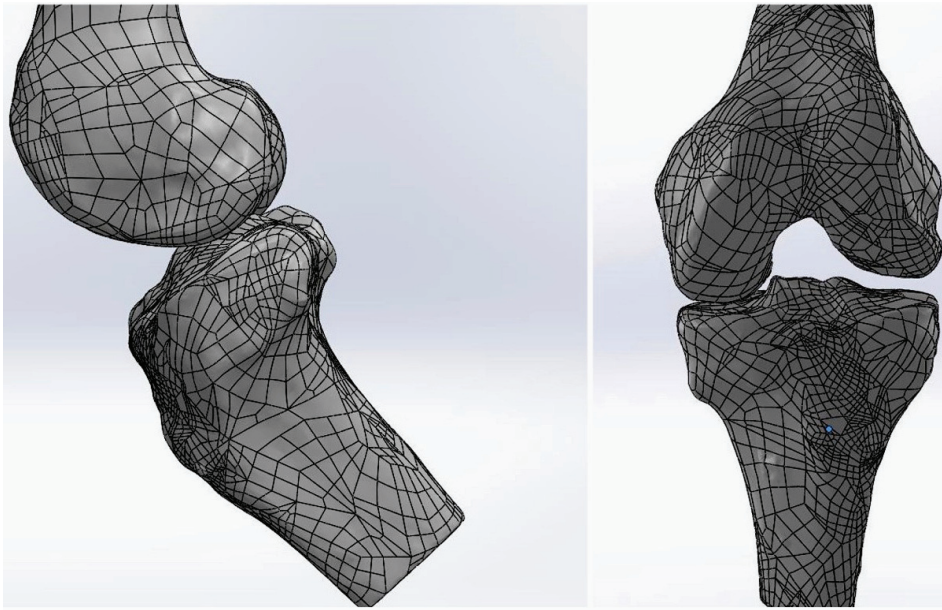

Fig. 6. Lateral view (left) and anterior view (right) of the tibiofemoral joint: note that a too short segment (“carriage”), for example 1 mm, causes the distraction of the bones’ lateral compartments during the flexion

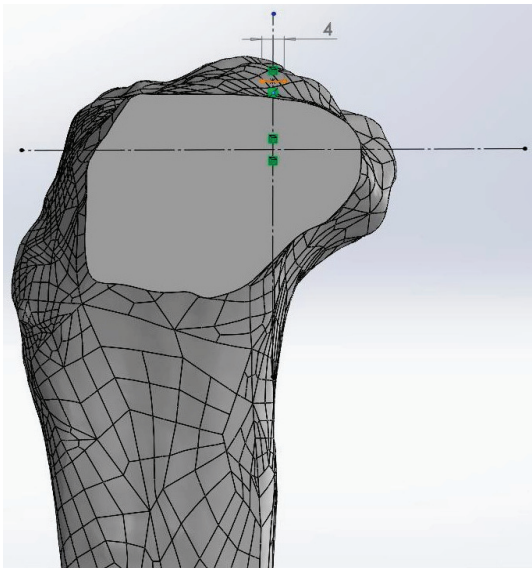

Fig. 7. Lateral view of the tibia: the “carriage” segment is drawn on the lateral plane among the tibial plateau and it measures 4 mm

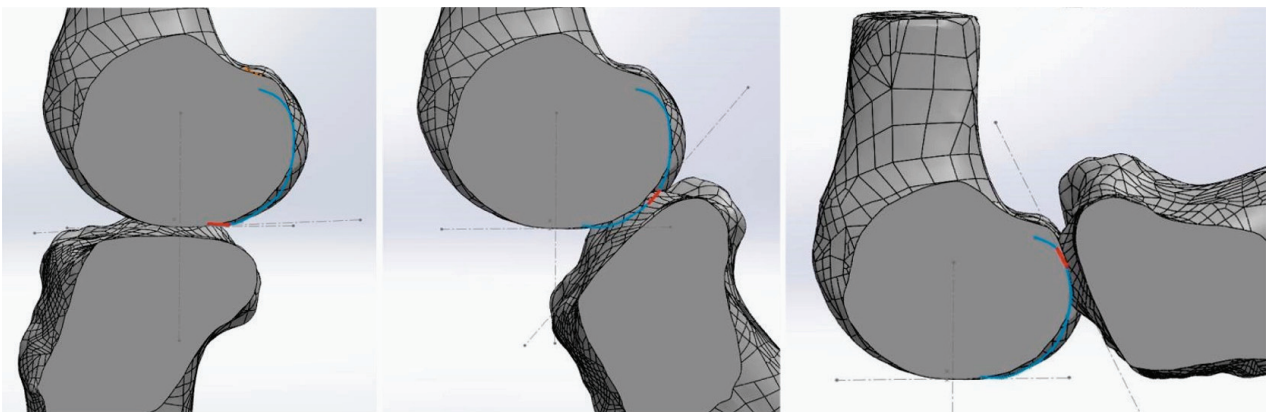

Fig. 8. Sagittal view in the lateral section of the healthy model: frames of the tibiofemoral kinematics on SolidWorks. The path on the lateral femoral condyle following by the tibia is shown by a light blue line and the “carriage” on the tibia by a red continuous segment

2.3.2. Patellofemoral joint

The patella is free to move and is constrained to the femur with the same technique used for the tibiofemoral articulation. The frontal and sagittal planes of the two bones are fixed together to match the posterior

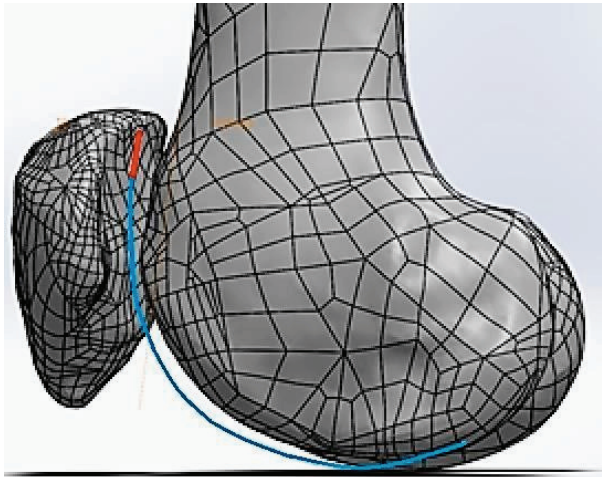

Fig. 9. Healthy model: patellofemoral joint with “carriage”-path mate in evidence. The path on the femoral groove following by the patella is shown by a light blue line, and the “carriage” on the patella by a red continuous segment

surface of the patella with the seat of the trochlear groove; a maximum distance of 6 mm is maintained between the two surfaces so as to take into account the cartilage which is not present in the model. The sagittal planes of the femur and the patella cannot change the angle between them during flexion.

The path that the patella follows along the femur profile is traced using the same idea applied to the tibiofemoral articulation, namely a “carriage” moving along a “track” i.e., the path (Fig. 9). The path is on a sagittal plane cutting the lateral femoral condyle; the “carriage” is on the patella at such a distance as to maintain a space in extension of less than 6 mm between the patella and the patellar groove in order to take into account the cartilage thickness. The considerations made regarding the tibiofemoral “carriage” can also be applied to the patellofemoral joint. Through the length of the patellar “carriage”, the movement of the patella is controlled: a length of 8 mm it is selected in order to have neither an excessive compression of the soft tissue nor an unnatural distancing of the patellar apex during knee flexion.

The method used to evaluate the height of the patella is the Insall-Salvati index which is the ratio of the patella tendon length with respect to the greatest

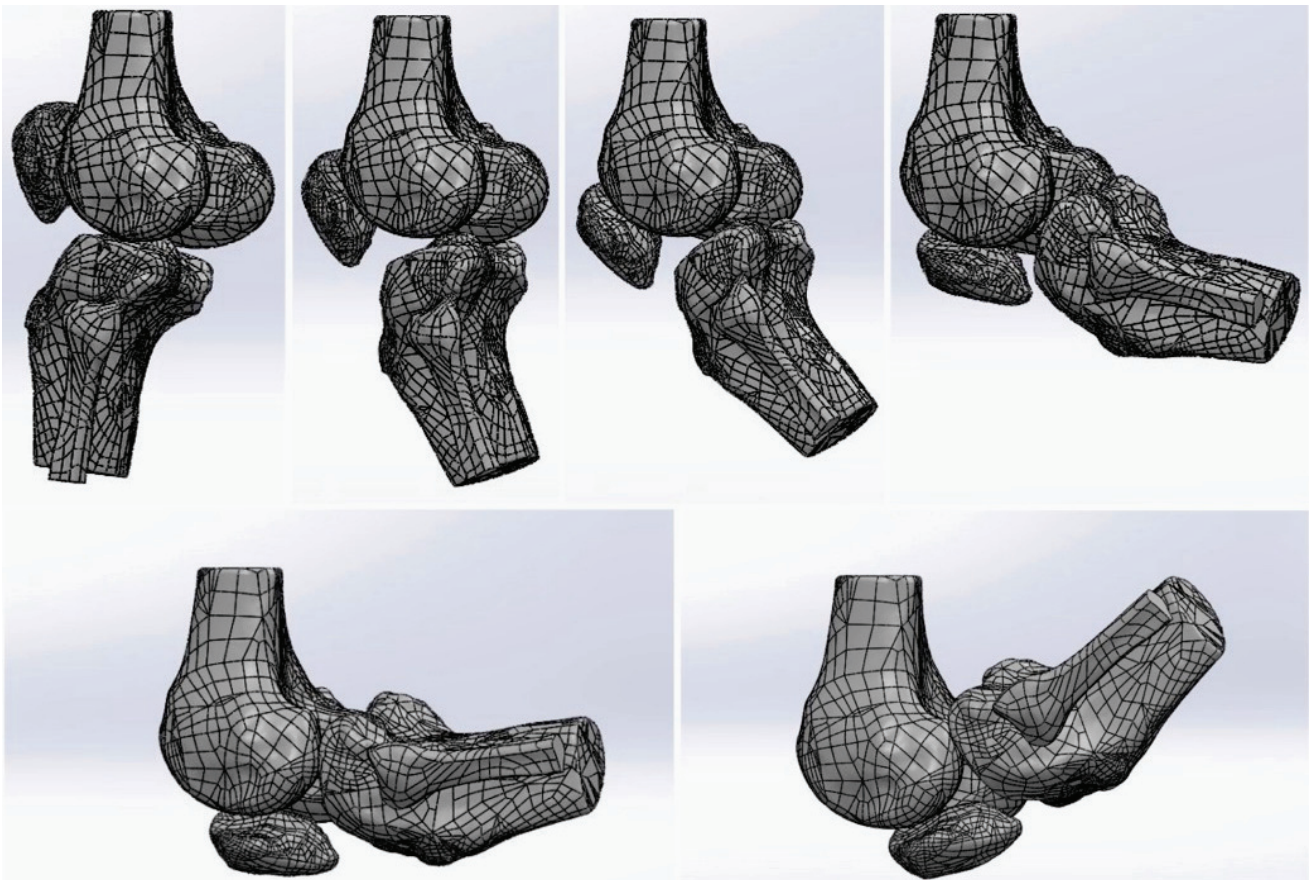

Fig. 10. Sagittal view of the healthy model: frames of the kinematics on SolidWorks from the hyperextension to deep flexion

diagonal length of the patella. The length of the patellar ligament is measured from the lower pole of the patella insertion to the tibial tubercle, and the greatest diagonal is measured from the upper to the lower patellar pole. The height of the patella is considered normal when the Insall-Salvati index ranges from 0.8 to 1.2 [17]. In the model, the Insall-Salvati index is equal to 1.08 which is within the physiological range.

To gain a better understanding of the healthy model, Fig. 10 shows a sagittal view from hyperextension to deep flexion.

2.3.3. Degrees of freedom of the healthy model

In general terms, the aim is to make the model represent reality as closely as possible; nevertheless, there are always limitations. The tibiofemoral joint in the healthy knee model allows the flexion-extension, the anteroposterior translation and the compression-distraction using the path mate whereas the internal-external rotation, the mediolateral translation and the abduction-adduction are restricted. The patellofemoral joint enables the flexion-extension, the anteroposterior translation and the proximal-distal translation but does not simulate the mediolateral translation, the external-internal rotation and the mediolateral tilt. The complex set of permitted and restricted movements of the healthy knee model are shown in Table 2.

Table 2. Permitted and restricted movements of the healthy knee model. Three allowed movements can be translated as three degrees of freedom in both the tibiofemoral and the patellofemoral joints of the model

HEALTHY KNEE MODEL	
<i>Permitted movements</i>	<i>Restricted movements</i>
Tibiofemoral joint – 3 DOF	
flexion-extension	internal-external rotation
anteroposterior translation	mediolateral translation
compression-distraction	abduction-adduction
Patellofemoral joint – 3 DOF	
flexion-extension	mediolateral translation
anteroposterior translation	external-internal rotation
proximal-distal translation	mediolateral tilt

The mediolateral translation and the abduction-adduction in the tibiofemoral joint are negligible with respect to the entire kinematic range (2 mm of mediolateral translation and 6–8 degrees of valgus and varus in extension). The main restriction concerns the internal-external rotation; from the results in a Canadian study [3] the effects in the healthy model can be

considered negligible with respect to the entire displacements.

2.4. Knee model with prosthesis

The knee model with prosthesis includes the femur, tibia, fibula and patella, patellar ligament, medial collateral ligament, lateral collateral ligament, quadriceps tendon and the prosthesis. The anterior cruciate ligament and the posterior cruciate ligament are sacrificed as a result of the surgery. The ligaments, bones and tendon properties are the same as the healthy model.

The healthy model is the starting point for the model with prosthesis: initially the surgical technique of total knee arthroplasty is simulated step-by-step to obtain the second. After fixing the prosthetic components, the movement is reconstructed following the same “carriage”-path principle used for the healthy joint (Fig. 11).

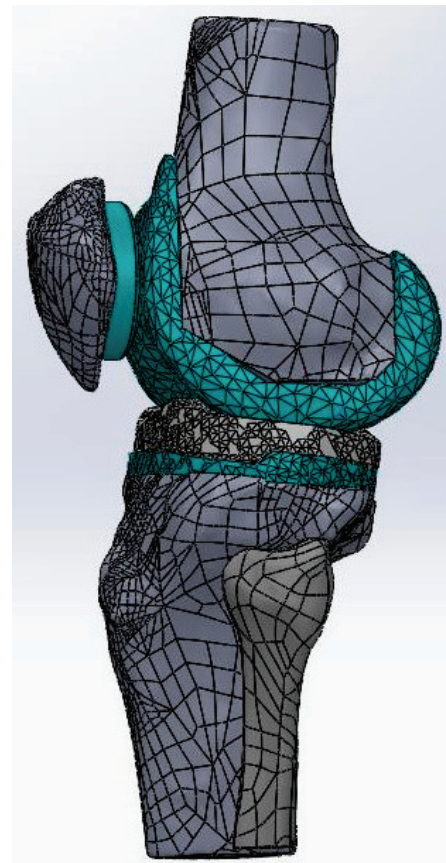

Fig. 11. Knee joint model with prosthesis developed from healthy model

2.4.1. The prosthesis

The first step to be taken before performing the surgery is the choice of the knee implant: for this study,

the Legion Total Knee System Posterior Stabilized (PS), developed by Smith & Nephew [24], was chosen. The femoral component PS is mated to an insert PS high flexion XLPE; the resurfacing patella has a thickness of 9 mm.

The geometry of the individual prosthetic components is acquired at WL3D company [27] using a 3D scanner with resolution equal to 50 micrometers, permitting to build a prosthetic model with high precision. For the kinematics study, it is necessary to find a compromise between the level of geometric detail required and the computational cost. After scanning, the number of faces of the mesh for each component is reduced using the software Blender [5], decreasing proportionally the file size. Subsequently, through the surfaces obtained in .stl format, the components are rebuilt using PTC Creo 3.0 and then imported into SolidWorks.

2.4.2. The bones resections

The models of the bones are resected following the surgical technique in order to introduce the prosthetic components. Just as the fixing of the implant is performed through the use of bone cement, lock constraints are used in the model. During the reconstruction of the patella, the simulated surgery removes an amount of bone equal to the thickness of the patellar button that is inserted, i.e., 9 mm, to replace exactly the quantity of bone removed. Due to the resection, the patella thickness is equal to 12.7 mm: the result is considered to be satisfactory since several studies show that values below 10–12 mm increase the risk of implant failure [15], [22].

2.4.3. Tibiofemoral joint

The femur is kept fixed as in the healthy model, while the tibia and the fibula are free to move. To model the sliding of the tibia on the femur, the same “carriage”-path concept developed for the healthy joint is used, adapting it to the prosthetic kinematics. The femoral block forces the insert stabilizer to rotate, blocking the anteroposterior sliding from a specified angle of bending, and ensuring rollback. In this model, the “carriage” segment is traced on the insert, which is locked to the tibial plateau and, therefore, able to move the tibia and the fibula with it. Following a thorough analysis of the sliding that the insert performs on the femoral condyles, two paths are drawn on the femoral component, one for each end of the “carriage” segment: in this way, greater control is obtained during the entire movement. During this study it

was discovered through experimentation that the use of one and only path is not able to reproduce sufficiently complex kinematics. The path created allows a range of movements between 5° of hyperextension and 138° of deep flexion, without taking into account the limits imposed on the model from the other anatomical parts, such as the length of the patellar ligament (Fig. 12).



Fig. 12. Sagittal view of the knee model with prosthesis: the “carriage” (blue) is shown on the insert and the two paths (orange) on the femur component

2.4.4. Patellofemoral joint

The patellar implant is positioned at the same height of the healthy model in order to maintain the length of the patellar ligament in extension unchanged. As in the case of the healthy model, the path is traced along the femoral profile which interacts with the surface of the patellar button. The segment which forms the “carriage” is drawn on the apex of the rounded prosthetic surface so as to easily control the tangency of the implant to the femoral surface. Starting from the maximum height in a standing posture, the patella will be dragged from the tibia through the patellar ligament. As in other joints, the curve is drawn to ensure the drag of the bone without intersection of the volumes and avoiding that the patella is locked by the end of path rather than by the joint kinematics.

2.4.5. The thickness variations of the patellar button

The standard thickness used, i.e., 9 mm, refers to the height of the button measured from the interface surface with the residual bone to the upper end of the dome that interfaces with the femoral component (Fig. 13).

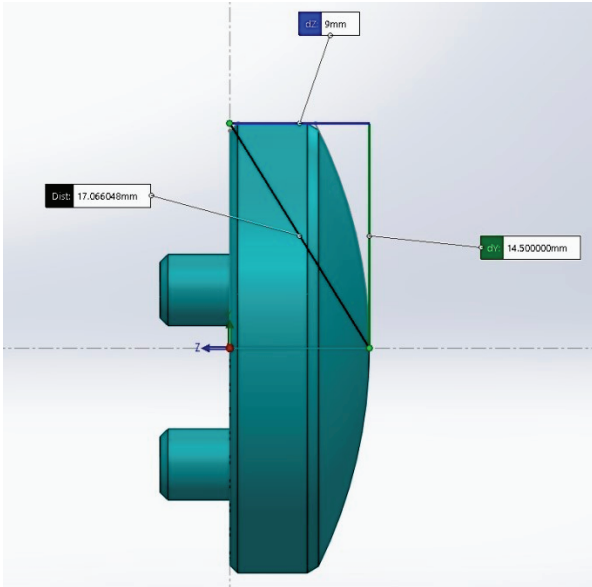

Fig. 13. Sagittal view of the patellar component: the thickness (blue) is measured from the posterior surface to the top of the dome

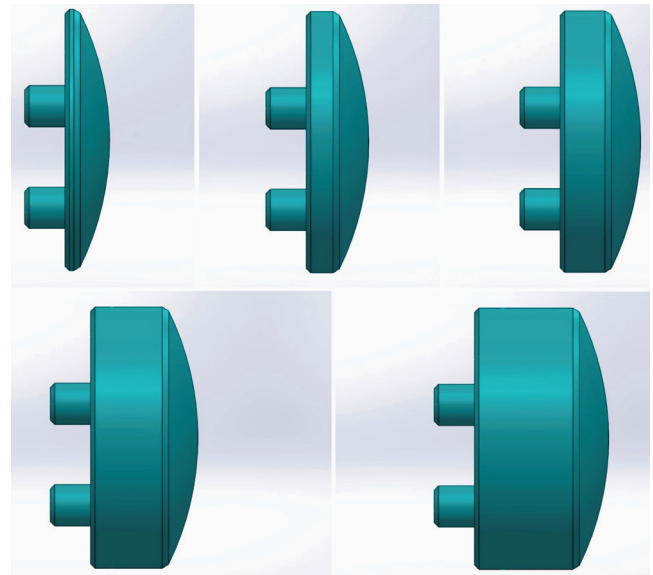

Fig. 14. Sagittal view of the patellar component: from left to right, and from top to bottom are 5 mm, 7 mm, 9 mm, 12 mm 15 mm thicknesses

The changes of the patellar thicknesses only interest the patellar prosthesis while the resection of the patellar bone remains unchanged. The “carriage” segment on the dome did not undergo any changes so that the results at the size changes will be comparable. The patellar button is drawn in SolidWorks after measuring the real component and comparison with the scan file.

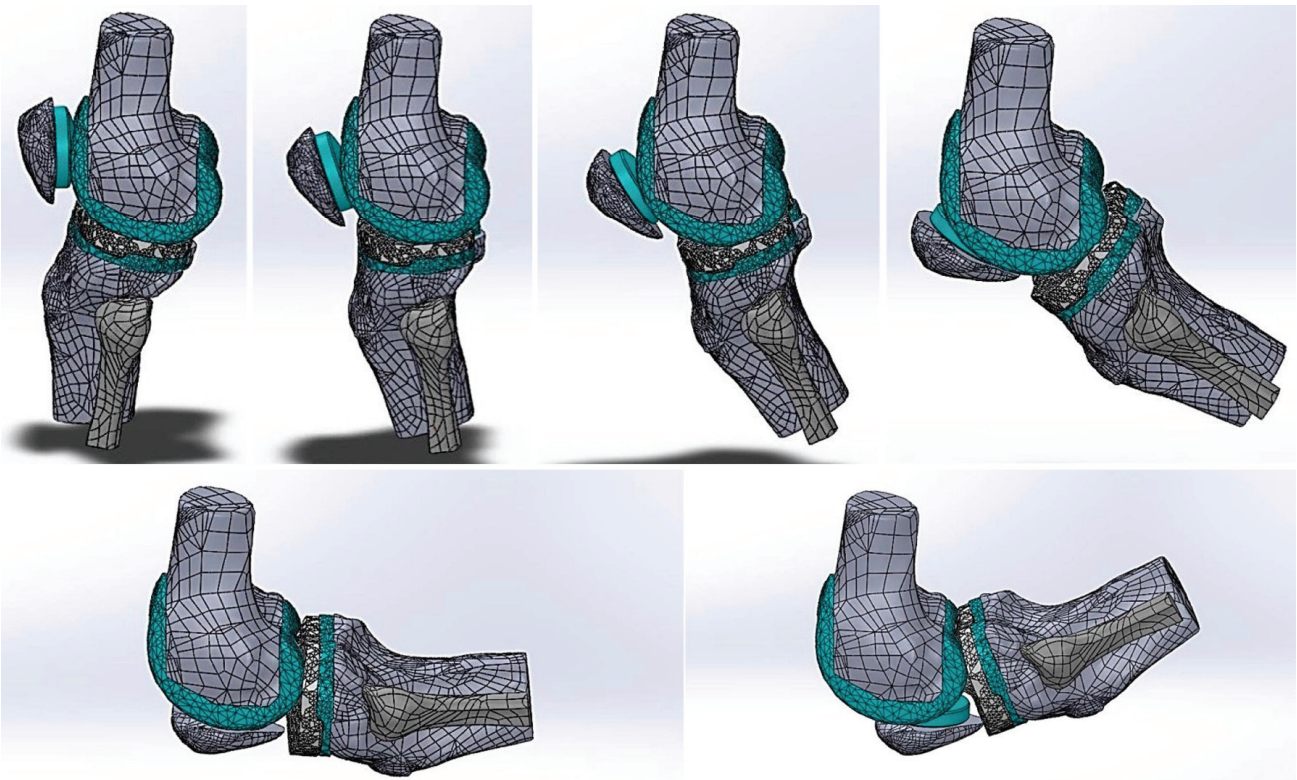

Fig. 15. Sagittal view of the model after TKA: frames of the kinematics on SolidWorks from the hyperextension to deep flexion

To change the thickness of the patellar component, the dome which interfaces with the femoral groove is maintained unaltered: in this way, the patellofemoral kinematics are not altered (Fig. 14). Furthermore, the carriage that is drawn on the patellar button does not change, and the results at different patellar sizes will be comparable.

The thickness of the patellar button is changed considering the relationship between the dimensions of the components themselves and between the patellar bone and the patellar prosthesis. Beyond 15 mm, the overall thickness of the bone with the implant would be physiologically modified: with this thickness it would already have a total thickness (bone plus prosthesis) equal to 27.7 mm, which exceeds any physiological range. Less than 5 mm is not considered relevant since the proportions between the collar and the dome, as between the button itself and the residual patellar bone, would be altered. Hence a range from 5 mm to 15 mm is assumed for the button thickness with 1 mm of increment, corresponding to a patellar thickness ranging between 17.7 mm and 27.7 mm.

The change of the patellar thickness during the simulations is not followed by a significant variation in the Insall-Salvati index which is always maintained within the physiological range.

Figure 15 illustrates the sagittal view of the model after Total Knee Arthroplasty (TKA) from hyperextension to deep flexion.

2.4.6. The degrees of freedom of the model with prosthesis

The tibiofemoral joint in the knee model after TKA allows the same movements of the healthy model with the exception of compression-distraction. The limitation of the translation along the longitudinal axis is required being related to the implant which restricts this movement – correspondingly it has two degrees of freedom. The patellofemoral joint allows the same movements of the healthy model with three degrees of freedom. The complex set of permitted and restricted movements of the knee model with prosthesis are shown in Table 3.

The mediolateral translation and the abduction-adduction in the tibiofemoral joint are negligible since, in the model which had undergone TKA, the implant itself introduces a restriction on these movements. The main restriction concerns the internal-external rotation; regarding the model with prosthesis, this restriction must be taken into account in the interpretation of the results. Correspondingly the collateral and cruciate ligaments are used to control and not

guide the articular movement. The limitations of the patellofemoral joint mainly involve the healthy articulation model, since the prosthetic design entails a major movement on the neutral axis of the patellar groove due to the geometry of the femoral condyles. Therefore, the patellofemoral limitations are negligible with respect to the results of this study.

Table 3. Permitted movements, and restricted movements of the knee model with prosthesis. The only difference between this model and the healthy model is in terms of the compression-distraction of the tibiofemoral joint, due to the prosthetic behaviour

KNEE MODEL WITH PROSTHESIS	
<i>Permitted movements</i>	<i>Restricted movements</i>
Tibiofemoral joint – 2 DOF	
flexion-extension	internal-external rotation
anteroposterior translation	mediolateral translation
	abduction-adduction
	<i>compression-distraction</i>
Patellofemoral joint – 3 DOF	
flexion-extension	mediolateral translation
anteroposterior translation	external-internal rotation
proximal-distal translation	mediolateral tilt

3. Results

The flexion values obtained from these simulations refer to a model in which the ligamentous fibers were subjected to preconditioning.

The first simulation related to the model with prosthesis was performed with the standard 9 mm button thickness; the maximum flexion obtained was 118.7°, constrained by the strain of the patellar ligament. This value is considered to be sensible based on the average range of motion of the Smith & Nephew's implant used in this study [24] and also on the basis of surgical experience.

The successive simulations were performed by increasing and decreasing the thickness of the patellar button, and the results are shown in Table 4.

The model refers to a specific subject because the anatomy of each individual always varies with respect to the average size: for this reason, the extrapolated results are to be considered subject-specific. Furthermore, the outcome of this study depends strongly on the bone thickness which remains after the surgery: a bone thickness higher or lower than that obtained and reported here, i.e., 12.7 mm, could change the results since the thickness of the bone-implant system would differ from the values considered in the study.

Table 4. With a residual patellar bone equal to 12.7 mm, the table reports the final patellar thickness, the thickness of the patella prosthesis, the relative thickness prosthesis/patellar bone, the maximum flexion, and the flexion loss over the button range evaluated

Patellar thickness [mm]	Thickness of patellar button [mm]	Thickness button/patellar bone [%]	Knee flexion [°]	Flexion loss [°]
17.7	5	39.4	118.7	0
18.7	6	47.2	118.7	0
19.7	7	55.1	118.7	0
20.7	8	63.0	118.7	0
21.7	9	70.9	118.7	0
22.7	10	78.7	115.6	3.1
23.7	11	86.6	100.3	18.4
24.7	12	94.5	100.3	18.4
25.7	13	102.4	100.3	18.4
26.7	14	110.2	98.3	20.4
27.7	15	118.1	98.3	20.4

It may be concluded that the results obtained depend on both the anatomy of the patella and the surgery performed on it. For this reason, Table 4 reports in the second column the absolute value of the button thickness and in the third column the relative value referred to the thickness of the remaining bone. Thus, it should be possible to extend the results of this analysis to other patient with different patellar thickness, by simply proportioning the patellar button to the new case.

To facilitate the interpretation of the results, Figs. 16a and 16b report the knee flexion angle as a function of the absolute and relative values of thickness of the patellar prosthesis respectively.

The trend is not smooth, implying that the variation of the knee flexion is not proportional to the variation of the patellar thickness. The standard size (9 mm) seems to correspond to the limit beyond which the performance of the implant decreases considerably. In comparison, the flexion decreases by 3.1° with a patellar button thickness of 10 mm, by 18.4° with a thickness between 11 mm and 13 mm, and by 20.4° beyond 14 mm. So, by applying a patellar button with thickness ranging from 9 mm to 15 mm, flexion angle decreases from 118.7° to 98.3°. Evaluating thicknesses below the standard size of 9 mm, the result does not change: by decreasing the thickness, in fact, the range of movement is not modified and continues to result in a maximum flexion of 118.7°.

These results could be attributed to the particular geometry of the joint, but it is hypothesized that a generalization could be applied based on the relative values. For this reason, the results are normalized by considering the ratio between thickness of the patellar implant and the remaining bone: the standard patellar button of 9 mm in this reconstruction is equal to 70.9% of the residual bone thickness. A value of the prosthetic thickness lower than 9 mm does not change the result of the surgery, bearing in mind that it is referred to values less or equal than 70.9% of the residue bone of the patient. Above, up to a thickness equal to 78.7% of the patella, the flexion loss is contained within 3.1°. Overcoming this implant-bone proportion, the reduction of movement becomes marked: starting from a relative thickness equal to 86.6%, the knee flexion reduces to 100.3° and beyond 110.2% it results in a further decline to 98.3°.

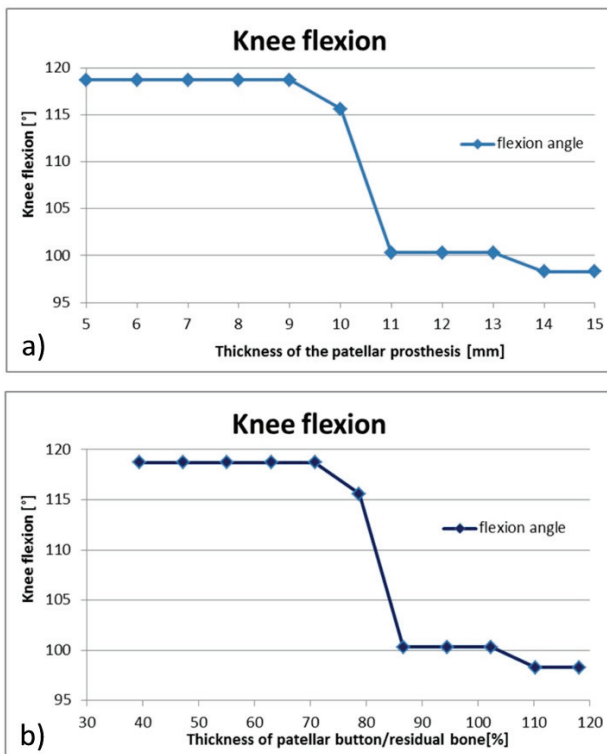

Fig. 16. (a) Degree of knee flexion as function of thickness of the patellar prosthesis measured in millimetres; (b) Degree of knee flexion as function of thickness of the patellar prosthesis related to patellar residual bone

From the results reported it can be concluded that, considering only the joint kinematics, the outcome of total knee arthroplasty is considered to be satisfactory with the standard 9 mm patellar button provided by Smith & Nephew [24] maintaining a thickness of residual bone equal to or less than about 71% of the thickness of the implant.

4. Discussion

The results of this study show that an increase in the button thickness over the standard value provided by the prosthesis producer generates a decrease in the maximum flexion, that tends to become negligible for the last patellar augmentation steps over 11 mm (i.e., over 86.6% of the residual bone). On the contrary, with a decrease of the button thickness, the flexion angle does not change. So, the trend in the variation of the range of movement is not gradual, in the sense that the extent of knee flexion is not proportional to the variation of the patellar thickness. These findings are in accordance with the experimental observations reported in other studies [4], [12]. In particular, the results found by Kim et al. in [12] revealed that the patellar thickness influences the extent of passive intra-operative knee flexion (which is known to be a predictor of the ultimate, post-operative range of motion), though its effects are not very marked, even in patients affected by fibroarthrosis, and the flexion loss rate in the range of patellar thickness between 11.5 mm and 15.5 mm is very similar to the one emerging from our numerical models.

However, it must be remarked that the results always depend strongly on the anatomical characteristics of the person subjected to the TKA and on the prosthetic design applied. Therefore, the outcome of this research cannot be compared straightforwardly with other studies, nor can be considered applicable to all types of knee implants commercially available, although it is possible to draw some general considerations concerning all patients using relative values. Based on the ratio between patellar button thickness and bone thickness, the results here shown can be extended to other patients with different levels of residual bone.

The reproduction of the movement using the software appears to confirm that the limit of the flexion depends on the strain of the patellar ligament. These findings are subject to model limitations due to some assumptions adopted for the sake of simplification

which are not perfectly realistic (i.e., the schematization of the ligaments as single bundles and the invariance of the angle between the patella and the femur), nonetheless, they are in line with a similar study by Abolghasemian et al. [2], which reports slightly different results compared to this work. It is hypothesized that the differences between the results are linked to the great differences in the models and the prosthetic geometries and in particular the surfaces of the femoral component. The flexion gap between 10 mm of thickness and 11 mm of thickness is related to the switching from the lower femoral surface to the posterior femoral surface: when the patellar thickness becomes too large, the tibia cannot glide to the posterior surface of the prosthetic condyles since the elongation of the patellar ligament impedes the movement, and the flexion decreases significantly. This suggests that a different implant can considerably change the results of surgery with different patellar thicknesses.

As a final remark, it is worth pointing out that a thorough cadaveric study would be beneficial to further confirm these findings. Special care should be devoted, in this case, to overcome the main problem of cadaveric studies, lying in the progressive damage of the soft tissue during biomechanical testing, especially while testing near the maximal range of motion.

5. Conclusions

The aim of this study was the reproduction using numerical simulations of knee kinematics in the period before osteoarthritis sets in and after surgery. Using a numerical model with the implant, a thorough analysis was performed on the patellar component in order to evaluate whether there was an improvement, or a worsening of the flexion reached by the joint when the patellar button thickness was varied. In the literature this topic is scarcely discussed despite playing an important role in the outcome of total knee arthroplasty. The results of the numerical simulations showed that flexion reduction is not linearly proportional to the patellar thickness and that the use of a standard patellar button thickness produces an overall satisfactory outcome of total knee arthroplasty, thus corroborating the usual surgery practice. The results of this study could be used to compare the kinematics with other total prosthesis and patellar implants, and should enable the optimization of the patellar residue bone thickness to obtain deep flexion.

Acknowledgements

The authors wish to thank Smith & Nephew company for allowing publication of the results.

References

- [1] ABDEL-RAHMAN E.M., HEFZY M.S., *Three-dimensional dynamic behaviour of the human knee joint under impact loading*, Med. Eng. Phys., 1998, 20(4), 276–290.
- [2] ABOLGHASEMIAN M., SAMIEZADEH S., STERNHEIM A., BOUGHERARA H., BARNES C.L., BACKSTEIN D.J., *Effect of patellar thickness on knee flexion in total knee arthroplasty: A biomechanical and experimental study*, J. Arthroplasty, 2014, 29(1), 80–84.
- [3] BENDJABALLAH M.Z., SHIRAZI-ADL A., ZUKOR D.J., *Biomechanics of the human knee joint in compression: reconstruction, mesh generation and finite element analysis*, Knee, 1995, 2(2), 69–79.
- [4] BENGIS B.C., SCOTT R.D., *The Effect of Patellar Thickness on Intraoperative Knee Flexion and Patellar Tracking in Total Knee Arthroplasty*, J. Arthroplasty, 2006, 21(5), 650–655.
- [5] BLAIN J.M., *The Complete Guide to Blender Graphics: Computer Modeling & Animation*, A.K. Peters (ed.), 3rd ed. CRC Press, 2016.
- [6] BLOEMKER K.H., GUESS T.M., MALETSKY L.P., DODD K.A., *Computational Knee Ligament Modeling Using Experimentally Determined Zero-Load Lengths*, Open Biomed. Eng. J., 2012, 6(1), 33–41.
- [7] CHANG K.-H., *Motion Simulation and Mechanism Design with SOLIDWORKS Motion 2017*. SDC Publications, 2017.
- [8] DHOLLANDER A.A.M., BASSENS D., VICTOR J., VERDONK P., *Patellar tilt and thickness do not influence postoperative flexion in a high-flex design total knee arthroplasty*, Knee Surgery, Sport, Traumatol. Arthrosc., 2013, 21(12), 2817–2822.
- [9] FARAHINI H., MOGHATAEAI M., BAGHERI A., AKBARIAN E., *Factors influencing range of motion after total knee arthroplasty*, Iran. Red. Crescent. Med. J., 2002, 14(7), 417–421.
- [10] GrabCAD. GrabCAD library. Retrieved from <http://grabcad.com>, 2018.
- [11] HAJDUK G., NOWAK K., SOBOTA G., KUSZ D., KOPEĆ K., BŁASZCZAK E., CIELIŃSKI Ł., et al., *Kinematic gait parameters changes in patients after total knee arthroplasty. Comparison between cruciate-retaining and posterior-substituting design*, Acta Bioeng. Biomech., 2016, 18(3), 137–142.
- [12] KIM A.D., SHAH V.M., SCOTT R.D., *The Effect of Patellar Thickness on Intraoperative Knee Flexion and Patellar Tracking in Patients With Arthrofibrosis Undergoing Total Knee Arthroplasty*, J. Arthroplasty, 2016, 31(5), 1011–1015.
- [13] KOH J.S.B., YEO S.J., LEE B.P.H., LO N.N., SEOW K.H., TAN S.K., *Influence of patellar thickness on results of total knee arthroplasty: Does a residual bony patellar thickness of ≤ 12 mm lead to poorer clinical outcome and increased complication rates?*, J. Arthroplasty, 2002, 17(1), 56–61.
- [14] KUBICEK M., FLORIAN Z., *Stress strain analysis of knee joint*, Eng. Mech., 2009, 16(5), 315–322.
- [15] LEE Q.J., YEUNG S.T., WONG Y.C., WAI Y.L., *Effect of patellar thickness on early results of total knee replacement with patellar resurfacing*, Knee Surgery, Sport, Traumatol. Arthrosc., 2014, 22(12), 3093–3099.
- [16] LI P.H., WONG Y.C., WAI Y.L., *Knee flexion after total knee arthroplasty*, J. Orthop. Surg., 2007, 15(2), 149–153.
- [17] MATH K.R., GHELMAN B., POTTER H.G., *Imaging of the Patellofemoral Joint*, [in:] *The Patella*, G.R. Scuderi (Ed.), Springer-Verlag, New York, 1995, 83–90.
- [18] Mimics. *Mimics User Manual. Version 13.1*. Leuven (Belgium): Materialise, 2011.
- [19] NÄGERL H., FROSCH K.H., WACHOWSKI M.M., DUMONT C., ABICHT C., ADAM P., KUBEIN-MEESBURG D., *A novel total knee replacement by rolling articulating surfaces. In vivo functional measurements and tests*, Acta Bioeng. Biomech., 2008, 10(1), 55–60.
- [20] O'BRIEN T.D., REEVES N.D., BALZOPoulos V., JONES D.A., MAGANARIS C.N., *Mechanical properties of the patellar tendon in adults and children*, J. Biomech., 2010, 43(6), 1190–1195.
- [21] PASTIDES P.S., SHENOY R., NATHWANI D., (iv) *The patella in total knee replacement*, Orthop. Trauma, 2013, 27(6), 372–378.
- [22] PIERCE T.P., JAUREGUI J.J., CHERIAN J.J., ELMALLAH R.K., HARWIN S.F., MONT M.A., *Is There an Ideal Patellar Thickness Following Total Knee Arthroplasty?*, Orthopedics, 2016, 39(1), 187–192.
- [23] SHENOY R., PASTIDES P.S., NATHWANI D., (iii) *Biomechanics of the knee and TKR*, Orthop. Trauma, 2013, 27(6), 364–371.
- [24] Smith&Nephew. (n.d.), *Smith & Nephew Legion prosthesis*. Retrieved from <http://www.smith-nephew.com/professional/products/all-products/legion/>
- [25] STÄUBLI H.U., SCHATZMANN L., BRUNNER P., RINCÓN L., NOLTE L.P., *Mechanical Tensile Properties of the Quadriceps Tendon and Patellar Ligament in Young Adults*, Am. J. Sports Med., 1999, 27(1), 27–34.
- [26] VANDENNEUCKER H., LABEY L., VICTOR J., SLOTEN J., VANDER DESLOOVERE K., BELLEMANS J., *Patellofemoral arthroplasty influences tibiofemoral kinematics: the effect of patellar thickness*, Knee Surgery, Sport, Traumatol. Arthrosc., 2014, 22(10), 2560–2568.
- [27] WL3D. (n.d.) WL3D. Retrieved from <http://www.wl3d.it>
- [28] WOO S.L.-Y., JOHNSON G.A., SMITH B.A., *Mathematical Modeling of Ligaments and Tendons*, J. Biomech. Eng., 1993, 115(4), 468–473.