

Windblown sand along railway infrastructures: A review of challenges and mitigation measures

Original

Windblown sand along railway infrastructures: A review of challenges and mitigation measures / Bruno, Luca; Horvat, Marko; Raffaele, Lorenzo. - In: JOURNAL OF WIND ENGINEERING AND INDUSTRIAL AERODYNAMICS. - ISSN 0167-6105. - ELETTRONICO. - 177:(2018), pp. 340-365. [10.1016/j.jweia.2018.04.021]

Availability:

This version is available at: 11583/2706876 since: 2018-05-11T10:23:26Z

Publisher:

Elsevier B.V.

Published

DOI:10.1016/j.jweia.2018.04.021

Terms of use:

This article is made available under terms and conditions as specified in the corresponding bibliographic description in the repository

Publisher copyright

(Article begins on next page)

Contents lists available at [ScienceDirect](http://www.sciencedirect.com)

Journal of Wind Engineering & Industrial Aerodynamics

journal homepage: www.elsevier.com/locate/jweia

Windblown sand along railway infrastructures: A review of challenges and mitigation measures

Luca Bruno^{a,b,*}, Marko Horvat^a, Lorenzo Raffaele^{a,b}^a Politecnico di Torino, Department of Architecture and Design, Viale Mattioli 39, I-10125, Torino, Italy^b Windblown Sand Modelling and Mitigation Joint Research Group, Italy

ARTICLE INFO

Keywords:

Windblown sand
Sand limit states
Sand mitigation measures
Railway infrastructures

ABSTRACT

The engineering interest about windblown sand is dictated by the harmful interactions between sand and a number of human infrastructures in arid environments. Particularly, the ongoing grand railway projects in the deserts of Far East, Middle East and North Africa regions require robust technical solutions to guarantee the efficient railway performance. The huge competences of the railway industry, traditionally developed in non-arid regions, should be developed and complemented to face mentioned challenges. The rationale problem setting, design, quantitative analysis and verification of sand mitigation measures are at present not sufficiently developed. The paper introduces original categorizations of both the windblown sand-induced performance deficiencies of the railway systems (windblown Sand Ultimate and Serviceability Limit States) and the prevention techniques to mitigate the windblown sand effects (Source-Path-Receiver categorization of the Sand Mitigation Measures). The state of the art is reviewed in the attempt to present the classification as accurately as possible. The main goal of the classification is to provide an orienting framework for scholars, railway owners, designers, general contractors and operators. We suggest the presented framework as a structured and organic base to properly set up future research activities, project terms of reference, most suited design solution, plan maintenance practices.

1. Introduction

The engineering interest about windblown sand is dictated by the harmful interactions that sand has with a number of structures and infrastructures in arid environments (Middleton and Sternberg, 2013), such as pipelines (Kerr and Nigra, 1952), industrial facilities (Alghamdi and Al-Kahtani, 2005), towns (Zhang et al., 2007), single buildings (Rizvi, 1989; Bofah and Al-Hinai, 1986), farms (Wang et al., 2010), roads (Redding and Lord, 1981), and railways (see Fig. 1). In particular, the wind-induced accumulation of sand is one of the specific key design challenges threatening safety and affecting serviceability and maintenance of railways in arid and desert regions.

A growing demand for windblown sand mitigation design, building and maintenance has been observed in the last decade and it is expected to further increase in the next 20–30 years. The increasing interest in windblown sand mitigation is testified by the growing number of published studies and filed patents in the last years. A non-exhaustive survey of studies cited in this review paper versus year of publication is shown in

Fig. 2 (a) while a non-exhaustive survey of patents about windblown sand mitigation measure versus filing year is shown in Fig. 2 (c). The patents landscaping has been performed through Orbit[®] patent database. The considered technologies are classified by the International Patent Classification (IPC) codes E01F 7/02 “Snow fences or similar devices, e.g. devices affording protection against sand drifts or side-wind effects” and E04H 17/00 “Fencing, e.g. fences, enclosures, corrals”.

Multidisciplinarity in windblown sand mitigation is testified by the graph in Fig. 2 (b), showing the distribution of the cited peer-reviewed studies among the addressed research fields. Given the high fragmentation in research fields, scientific affiliations have been reduced to three main research area, i.e. engineering disciplines, environmental sciences, and applied mathematics and physics. Studies classified in environmental sciences come from Geology, Ecology, Geography. Engineering disciplines comprehend Structural, Mechanical, Geotechnical, and Transport engineering. It is worth stressing that several cited studies cross over more than one research area.

Despite the development of ad-hoc studies for specific projects, a

* Corresponding author. Politecnico di Torino, Department of Architecture and Design, Viale Mattioli 39, I-10125, Torino, Italy.

E-mail address: luca.bruno@polito.it (L. Bruno).

URL: <http://www.polito.it/wsmm> (L. Bruno).

<https://doi.org/10.1016/j.jweia.2018.04.021>

Received 6 March 2018; Received in revised form 19 April 2018; Accepted 29 April 2018

Nomenclature			
ANR	Arab Network Railway	RDP	Resultant Drift Potential
AR	Aspect Ratio	S4S	Shield for Sand
DP	Drift Potential	SLS	Sand Limit State
ETS	Erosion Transport Sedimentation	SMM	Sand Mitigation Measure
GCC	Gulf Co-operation Council	SPR	Source-Path-Receiver
GR	Gulf Railway	SRM	Sand Removal Machine,
IPC	International Patent Classification	SSLS	Sand Serviceability Limit State
KSA	Kingdom of Saudi Arabia	SULS	Sand Ultimate Limit State
MENA	Middle East North Africa	SVW	Straight Vertical Wall
PVC	Percentage Void Contamination	UAE	United Arab Emirates
		WD	Wheel Detector

systematic and comprehensive problem setting and solving is still missing. Furthermore, to our best knowledge, a common nomenclature about windblown sand induced effects on railways does not exist. Authors refer to these effects by using different nomenclature: e.g. “sand disasters” (Cheng et al., 2015; Shi et al., 2016), “sand damage” (Cheng and Xue, 2014), “aeolian hazard” (Boulghobra et al., 2016; Rizvi, 1989; Stipho, 1992), “sand risk” (Boulton et al., 2014), “sand storm impact” (Pyrgidis et al., 2017), or combination of mentioned nomenclature (Behbahani, 2015).

In order to deal with these open issues, we adopt a problem-and-solution approach: first an original categorization of the windblown sand induced performance deficiencies is introduced; then, the prevention techniques capable of mitigating windblown sand effects are arranged on the basis of the new categorization we propose. The evolving state-of-art is reviewed in light of such categorizations. The resulting framework is addressed to scholars, railway owners, designers, general contractors and railway operators as a structured base to properly set up project terms of reference, most suited design solutions and plan maintenance practices.

2. Historical review of desert railways

2.1. Past railways across deserts

Historically, the first railways along deserts have been built by colonial countries. The British military railway was built at the end of the 19th century (1897–1899) from Wadi Halfa to Abu Hamed over the Nubian desert (Sudan, Winchester and Allen, 1935a, b). The French railway from Mecheria to Ain Sefra in Algeria was opened in 1887 (Belkacemi, 1984) across the norther part of the Kenadsa desert, and then extended to Beni Ounif in 1903, and to Colomb-Bechar in 1906 (Winchester and Allen, 1935b), in the framework of the never finished *Trans-Saharan Railway* project (1870–1941 Heffernan, 2010). The best example of a German railway is the line from Aus to Lüderitz built in 1906 over the Namib desert (Namibia, Dierks, 2004). The Hejaz Railway was built from Damascus to Medina, through the arid Hejaz region of Saudi Arabia and was a part of the Ottoman railway network built from 1900 to 1908 with German advice and support (Nicholson, 2005). At the present time, most of the mentioned lines are partially or totally decommissioned, and their remains buried by accumulated windblown

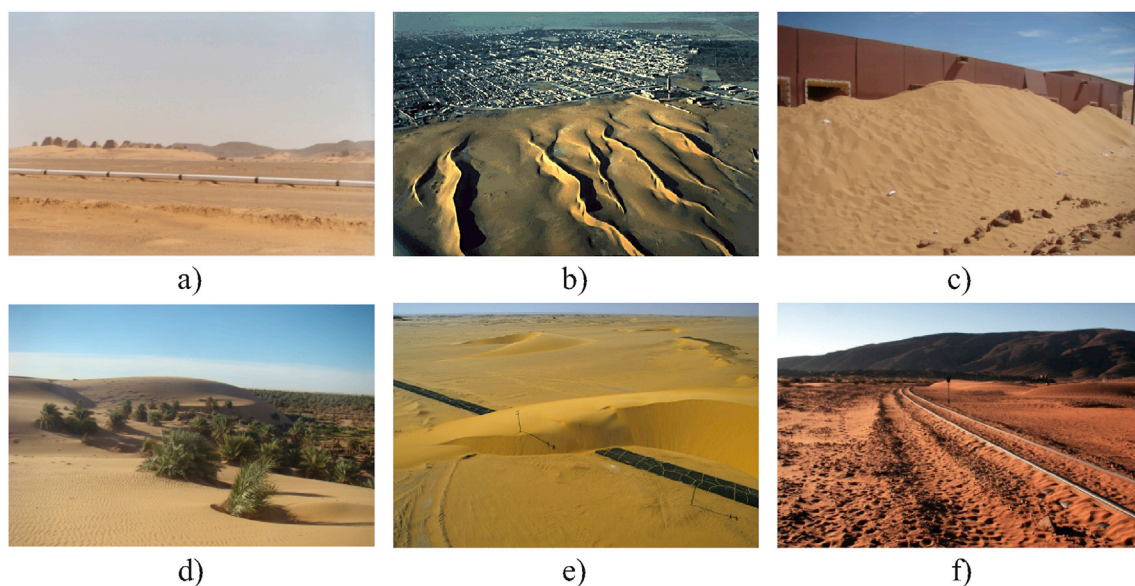

Fig. 1. General windblown sand induced problems: a) pipeline in the desert (explicit publishing permission from the owner of the photo: gordontour@Flickr), b) invading sand dunes in front of a city (reprinted from: Preziosi et al., 2015, with the permission from Elsevier), c) encroached single building (explicit publishing permission from the owner of the photo: Nouar Boulghobra), d) sand-invaded palm plantation (explicit publishing permission from the owner of the photo: Nouar Boulghobra), e) sand covered road (explicit publishing permission from the owner of the photo: Yann Arthus-Bertrand), f) railway in the desert (courtesy of Astaldi).

sand or encroaching dunes. An example of the Grasplatz railway station along the Aus to Lüderitz railway before and after the sand hazardous effect can be seen in Fig. 3.

From the reviewed literature, the first Sand Mitigation Measures (SMMs) for railways have been empirically tested along the Kundian-Mianwali section of the Sher Shah-Attock line in the arid Punjab province of Pakistan (probably built in 1891, surely in service in 1910, [Rahim, 1945](#)). The 550 km long Dammam-Riyadh line is the first pioneering modern railway whose design systematically addressed the windblown sand challenges (Kingdom of Saudi Arabia, 1947–1950, today in service). The team of American designers guided by J.H. Gildea tackled the problem of “Combating the engineering obstacles of locating track on sands that drift constantly like snow. It was, in fact, this similarity to snow that provided an important key to solving the difficulty. As strong prevailing north-west winds, known in Arabia as chamals, kept the sand in continual movement, engineers employed plows and spreader, previously successful in snow operations, to level and clear the wavelike dunes. Fences, comparable to snow fences, were erected along the right of way. Heavy coatings of crude oil were applied and the heavy crust thus created not only held the sand firm beneath it but provided a surface over which the blowing sand would not hold” ([Henry, 1952](#)). It is worth pointing out that engineers were applying technology known from the snow mitigation, even though sand and snow have dramatically different physical properties and the first influential book on the physics of windblown sand had been published 10 years before ([Bagnold, 1941](#)). In other words, at early stages of the development, sand mitigation measures were suffering the scarce transfer of knowledge from base and specialist research fields (e.g. Aeolian Geomorphology, Fluid and Porous Mechanics, Wind Engineering) to the Civil and Transportation Engineering design practice.

In 1956, 40 km of the Batou-Lanzhou railway was constructed in the south of the Tengger Desert, China ([Mitchell et al., 1996](#)). The railway was massively buried by mobile dunes since its construction. In the following years, a procedure for establishing an artificial ecosystem on mobile dunes was started by application of straw checkerboards over the mobile sand source ([Liu, 1987](#)). This technique has been widely used in China along a number of railway lines (for the full list of the railway lines, interested readers are referred to [Yu Qiu et al., 2004](#)). All the mentioned historical lines can be seen in Fig. 4.

2.2. Present railways across deserts

At the present time, most of the in-service railway lines crossing deserts and arid regions are located in north-western China with a total length of about 10.000 km ([Lianchan, 1984](#); [Lianchan et al., 1994](#); [Cheng and Xue, 2014](#)). For example, the Lanzhou-Xinjiang line across the Gobi desert (1904 km, completed in 1990, [Cheng et al., 2015](#)), the



Fig. 3. Grasplatz railway station along the Aus to Lüderitz railway before (a) and after (b) sand dune encroaching (permission to reuse under a Creative Commons Attribution License; owner of the photos: [Dierks, 2004](#)).

Xining-Lhasa line along the Tibet plateau (1956 km, completed in 2006), the Linhai-Ceke line across the Ulanbuhe, Yamaleike, and the Badain Jaran Deserts (707 km, completed in 2009). Despite the tremendous effort of the Chinese scientific community in the past 15 years, China has the greatest windblown sand disaster distribution along its railway network ([Cheng et al., 2015](#)). The Linhai-Ceke line seems to be one of the most vulnerable ones: in the first year of operation, over 10.000 workers were mobilized and CNY 71 million was spent on windblown sand-induced maintenance; service was suspended for two months in the spring of 2010; in the first 36 days after passenger service was introduced in November 2010, sand storms buried the track for 27 days and caused 51 service disruptions. Sand storms have reduced effective speed on eight sections of track between Suhongtu to Swan Lake to 25 km/h ([Moham and Yuanyuan, 2010](#)).

A report of sand hazards from India was given in a detailed survey of railways in the desert and semi desert areas of Rajasthan by [Nathawat and Sharda \(2005\)](#) An overall length of about 1250 km is prone to windblown sand in the Jodhpur and Bikaner Divisions of the NW Railway. The survey includes the list of windblown sand induced accidents per year (1–2 derailments, 3–7 days of service disruptions) and manpower lost on sand removal activities (about 1480 man-day per year).

Apart from Far East, most of the in-service desert railways are located in the Middle East - North Africa (MENA) region. The cited Dammam-Riyadh line in KSA has recently suffered a service suspension due to a windblown sand-induced train derailment ([Gazette, 2013](#)). The precise mapping of the in-service railway lines along sandy areas is available for the Iranian railway Network: an overall length of 416 km ([Zakeri and Forghani, 2012](#)) is exposed to windblown sand, with severe operational difficulties in the Bafgh-Mashhad line along the Lout desert. At the present time, two other main lines are in the testing and commissioning stage in the Arabic peninsula. The North-South Railway is a 2400 km

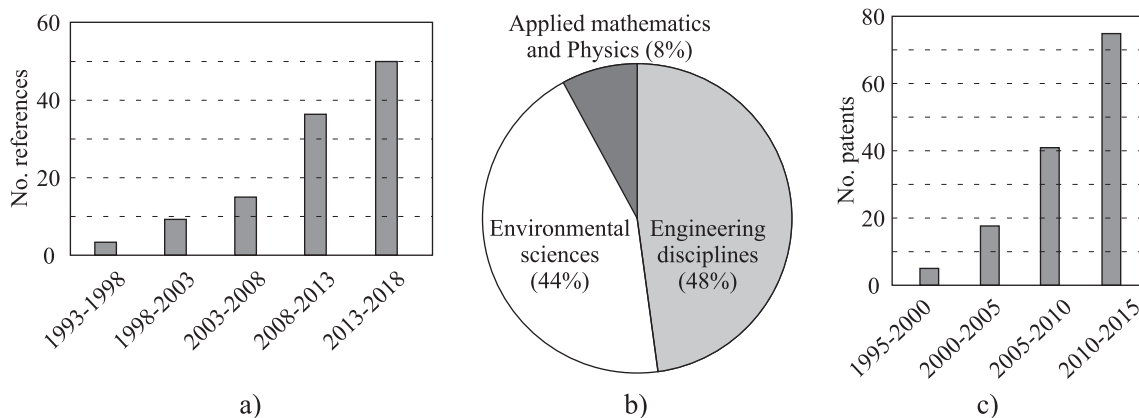

Fig. 2. a) Number of cited references classified by the year of publication, b) classification of references according to the research area, c) increasing trend of filed patents through years.

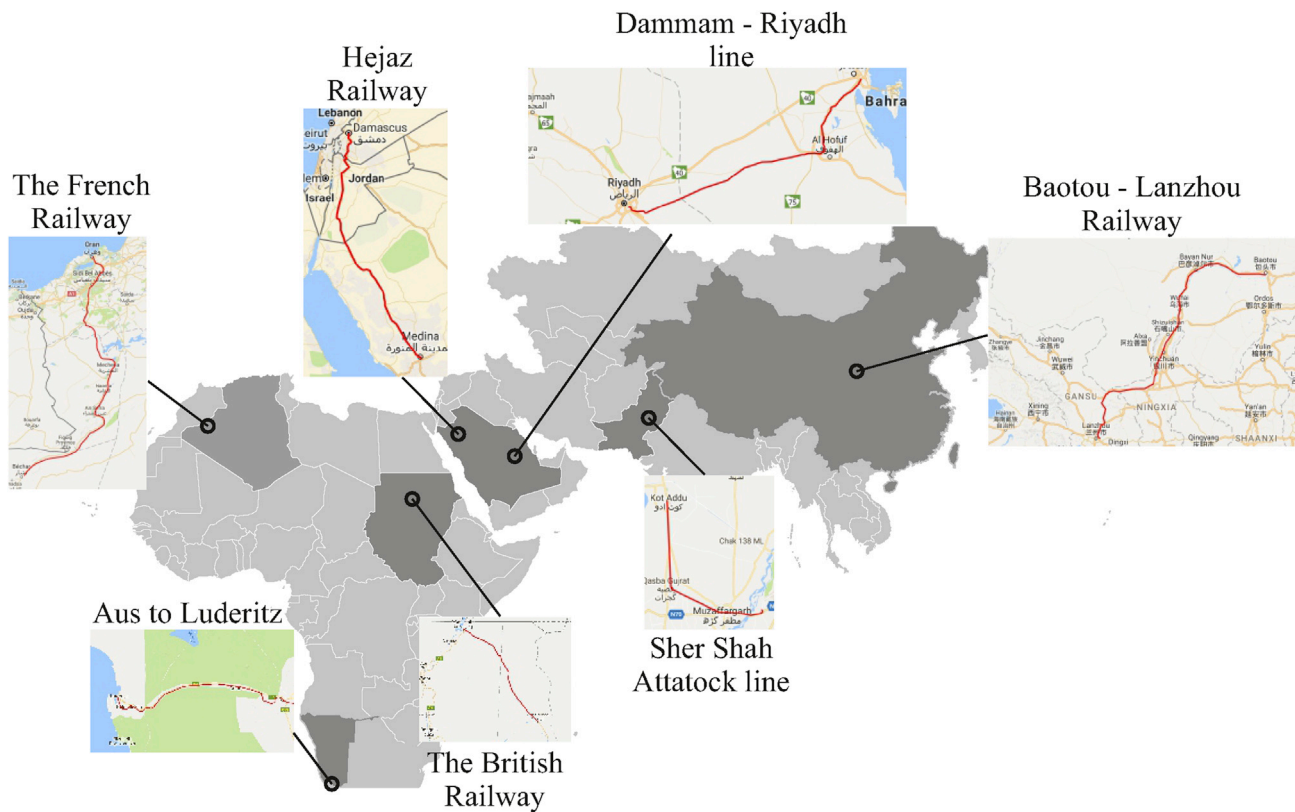

Fig. 4. Historical railways in the desert.

long railway project in Kingdom of Saudi Arabia (KSA) (Al Rumaih, 2009). The so-called phase 1 of the Etihad Rail network is a 266 km long line from Shah and Habshan to Ruwais in the United Arab Emirates. In the same time, the 450 km long Haramain High Speed railway between Medina and Mecca is under construction. Despite the ad-hoc dedicated studies during the design phase (Plaza et al., 2012), the construction advancement is suffering significant delays, also due to the windblown sand accumulation along the line under construction and the retrofitting of the designed SMM (e.g. Junquera, 2014; Gomez and Mèndez, 2015). On the other side, some desert trains in Africa are converted into touristic attractions thanks to windblown sand (e.g. the Oriental Desert Express in Oujda-Bouarfa, Morocco or the Desert Express in Windhoek-Swakopmund, Namibia).

2.3. Future railways across deserts

In the short and mid term, the railway lines in desert and arid regions are expected to rapidly grow, particularly in the MENA region. The Arab Countries are conceiving, evaluating and building a large railway network at different scales. The Arab Network Railway (ANR, preliminary study by the consortium Italferr-Dar El Omran, 2009–2012) is a 30.000 km long, high-speed/high-capacity railway network conceived to connect all the Arab League Countries across Middle East and North Africa. It is worth pointing out that the length of such a single project is more than twice the overall European high-speed railway network currently in operation and under construction. The Gulf Railway (GR) is a 2.217 km long project proposed to connect six Arab Gulf Co-operation Council (GCC) member states. In this framework, national railway networks are currently under design and/or construction, e.g. the Oman, UAE and KSA ones. The corresponding investments are significant. For instance, the Middle East Countries have allocated about USD 260 billion to build 40.000 km of railway tracks up to 2030 (MEED Insight, 2014). The map of the mentioned railways currently in service, in construction and future proposed is shown in Fig. 5.

3. Windblown Sand Limit States

The lack of a common categorization of windblown sand induced effects on railways triggered us to propose a new general framework, shown in the upper part of Fig. 6. In general terms, under a given incoming windblown sand drift (input) the overall infrastructure (system) is characterised by a resulting level of performance (output). In the scope of the present work, the focus is put on the railway infrastructure, defined as a set of 4 railway components: i. Civil works; ii. Track superstructure; iii. Rolling stock; iv. Signalling system. We introduce Sand Limit States (SLSs) as threshold performance levels, beyond which the railway no longer fulfills relevant design criteria. SLSs are set in analogy to other safety formats in different branches of Civil Engineering (e.g. EN, 1990, 2002). SLSs are further classified in Sand Ultimate Limit States (SULSs) and Sand Serviceability Limit States (SSLs) as follows: i. attaining SULSs involves service interruption and/or passengers unsafe conditions; ii. attaining SSLs involves railway partial loss of capacity and/or passenger discomfort.

The windblown SLSs are adopted as a main classification criterion, while the railway components attaining them as the secondary (see Fig. 6). Because of the different railway components above and related technical disciplines, SLSs classification and discussion includes aerodynamic issues, but also goes beyond them.

3.1. Incoming windblown sand drift

In the following, we refer to windblown sand as an environmental variable action, in analogy to other actions in engineering areas, such as thermal action (EN, 1991-1-5, 2003), fire action (EN, 1991-1-2, 2002), corrosion (ISO 9223, 1992), wind action (EN, 1991-1-4, 2005), wind-blown snow (EN, 1991-1-3, 2002) or ice action (Dehghani-Sanij et al., 2017). Incoming windblown sand is defined as the amount of sand carried by the incoming wind undisturbed by the infrastructure, in analogy to the incoming mean wind velocity in wind engineering practice. Windblown

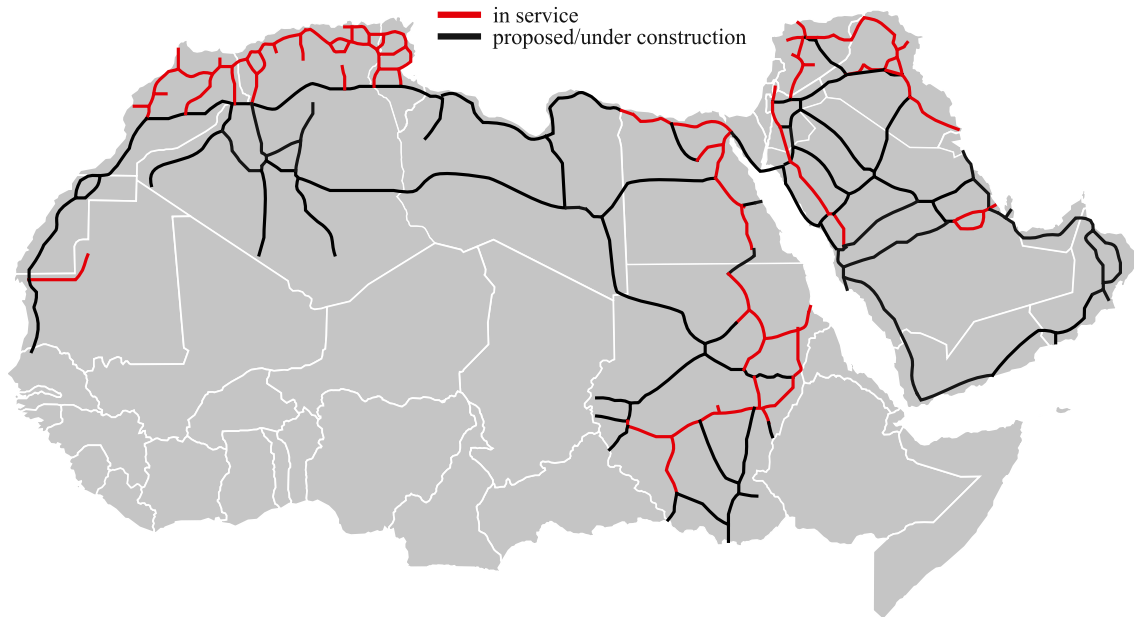

Fig. 5. Map of currently in service, under construction, and proposed railways in MENA region. Data collected and map drawn by the authors.

sand transport is a complex phenomenon resulting from the interaction of two physical subsystems, i.e. the wind and the sand. Depending on the grains diameter d , sand is transported through different modes of motion, i.e. creeping ($d > 0.5mm$), saltation ($0.5 > d > 0.07mm$) and suspension ($d < 0.07mm$) (Bagnold, 1941; Shao, 2008) (see Fig. 7 a).

Among them, saltation is recognized as the mechanism which mainly contributes to the overall transported sand mass (Kok et al., 2012). Only the sand grains with a diameter in the range from $0.07 - 2mm$ are taken into account, because an ensemble of particles with smaller diameter is defined as dust. Dust has much different physical properties which allow it to be transported over very long distances in processes called short and long term suspension (e.g. Pye, 1987; Goudie, 2009). Windblown sand saltation flux q results from the shear stress τ induced by the wind over the sand bed (see Fig. 7 b). τ is proportional to the rate of change of a wind velocity u_w in vertical direction ($\tau \propto \partial u_w / \partial z$) and is usually expressed in term of wind shear velocity $u_* = \sqrt{\tau / \rho}$. If the shear stress acting on the sand bed exceeds a certain threshold ($u_* > u_{*t}$), sand grains are entrained into the lower part of atmospheric boundary layer, grain bouncing is triggered and saltation occurs. The resulting sand flux $q(z)$ [$kg\ m^{-2}s^{-1}$] is defined by the product of the sand grain velocity $u_s(z)$ and the sand density $\rho_s(z)$, whose distribution follows a decreasing exponential function in vertical direction (Zheng, 2009). The sand transport rate Q [$kg\ m^{-1}s^{-1}$] is a bulk metrics derived from the sand flux given by its integration in the vertical direction, i.e. $Q = \int_0^\infty q(z) dz$. However, Q is usually estimated by semi-empirical models, reviewed in Dong et al.

(2003), Kok et al. (2012), Sherman and Li (2012). Among them, the most applied are the so-called modified Bagnold type models in which Q is a function of the effective shear velocity $u_{*,eff}$ (Raffaele et al., 2018), defined as:

$$Q \propto u_{*,eff} \alpha u_*^p - u_*^p \tag{1}$$

where p is the general exponent of the shear velocity and threshold shear velocity. Most of Q semi-empirical models adopt $p = 2$, even if there is not unanimity on it (see e.g. Martin and Kok, 2017). Such models are macroscopic constitutive laws that do not explicitly account for the variability of both wind and sand subsystems. The effects of the variability of the wind subsystem have been first accounted for in average term by Fryberger and Dean (1979). They introduced the so-called Drift Potential (DP) to evaluate the cumulative value of the sand transport rate. For a given wind direction, DP is expressed as:

$$DP = \frac{T}{\Delta t} \frac{1}{n} \sum_{i=1}^n Q_{i,\Delta t} \Delta t, \tag{2}$$

where, n is the number of $Q_{i,\Delta t}$ instances taken into account used to average the value of DP over an arbitrary time period ($T_r = n\Delta t$). $Q_{i,\Delta t}$ is the i -th value of sand transport rate, evaluated by means of one of the Q semi-empirical models over the wind sampling time Δt (e.g. 10 min), and a $T/\Delta t$ is a factor used to normalize DP to a time scale of an arbitrary reference time. DP [$kg\ m^{-1}T^{-1}$] defined in such a way is giving an

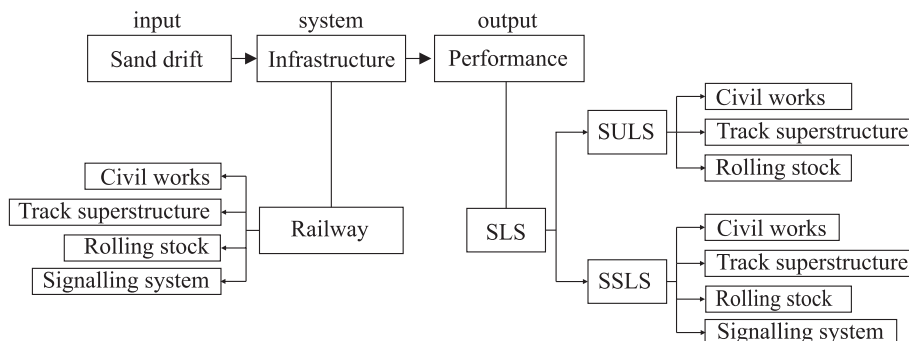

Fig. 6. Framework scheme of the safety standards.

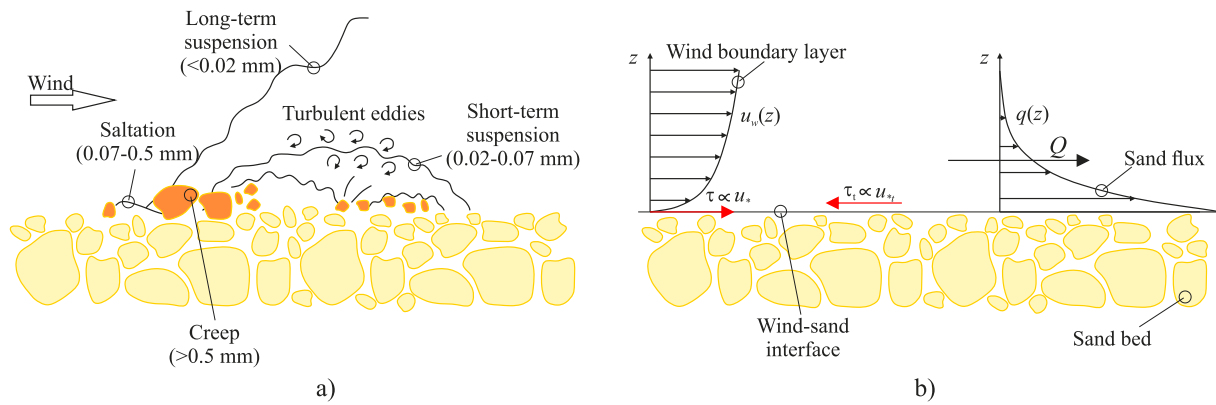

Fig. 7. a) Sand transport modes of motion (redrawn from: Pye, 1987), b) wind-sand interaction in saltation.

averaged amount of sand mass accumulated over the unit length of cross-wind direction and over the reference time T . $T = 1$ year is usually adopted in the field of sand mitigation. DP is graphically represented by a so-called sand rose, as shown in Fig. 8.

Each arm of the sand rose represents DP from a given direction towards the center circle. The Resultant Drift Potential (RDP) is the vector sum of drift potentials, defined by the Resultant Drift Magnitude (RDM) and Resultant Drift Direction (RDD). These quantities are called potentials because they refer to an ideal sand bed, i.e. actual ground surface properties (e.g. sand or vegetation covering) are not taken into account. The Fryberger and Dean (1979) framework is currently widely applied in a number of scientific and technical fields, e.g. highway engineering (Dong et al., 2004), railway engineering (Zhang et al., 2010a; Cheng et al., 2015; Xie et al., 2017), geomorphology and environmental sciences (Al-Awadhi et al., 2005; Zhang et al., 2013; Yang and Shi, 2018; Hereher, 2014; Boulghobra, 2016).

The effects of the variability of the sand subsystem on the threshold shear velocity (u_{*t}) have been investigated in a number of papers, reviewed in Raffaele et al. (2016). The effects of the variability of u_{*t} on the windblown sand transport has been recently assessed in Liu et al. (2017) and Raffaele et al. (2018). The evaluation of DP in a fully probabilistic approach is firstly introduced by Raffaele et al. (2017), where both the variability of wind and sand subsystems are taken into account. In this approach, DP is a random variable, described not only by its average value but also by higher statistical moments and percentiles.

3.2. Sand Ultimate limit states

The Sand Ultimate Limit State is mainly attained by civil works, e.g. embankment or cutting buried by sand. Because of the state of civil works, the track superstructure and rolling stock attains it in turn. To our

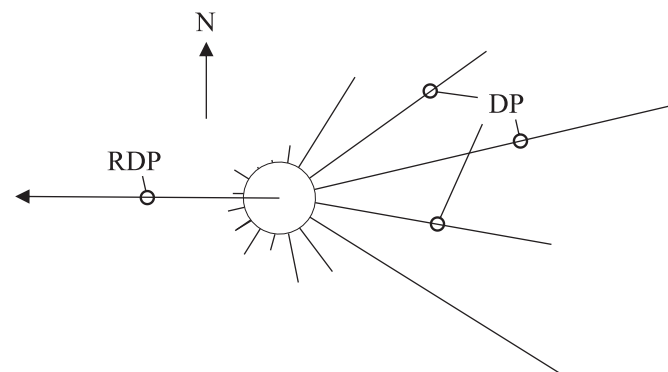

Fig. 8. Sand rose of Drift Potentials and Resultant Drift Potential (redrawn from: Fryberger and Dean, 1979).

best knowledge, the remaining reviewed system components (i.e. signalling system) do not suffer SULSs. Under SULS, the windblown sand completely inhibits infrastructure operation. Hence, SULSs are attained on the whole or a section of the railway.

3.2.1. Civil works

Schematically, railway body is susceptible to be buried by windblown sand under two conditions:

- the railway line crosses a migrating dune field, i.e. an area covered by transverse or barchan dunes (Fig. 9 a). Such dunes advance with little or no change in shape and dimension (Tsoar et al., 2004). The velocity of barchan dunes varies with the dune height. For example, a 3 m high dune propagates at a velocity from 15 to 60 m/yr, while a 15 m high dune with a velocity ranging from 4 to 15 m/yr (Andreotti et al., 2002). Dune encroachments across railway lines are reported by Mitchell et al. (1996) and Dierks (2004);
- the railway line crosses a sandy plane, where the ground surface is covered by a thin sand sheet. The railway body (embankment and/or cutting) acts as an obstacle to the incoming wind flow, inducing a deceleration of the flow at the upwind toe and a recirculation region downstream (e.g. Xiao et al., 2015). The reduction of the wind velocity and the shear stress promotes sedimentation of the windblown sand over the infrastructure, resulting in a partial (Fig. 9 b) or full covering of the railway body. The degree of coverage depends, besides the incoming sand transport rate, on time. Regardless of the degree of coverage, the sedimented sand induces the railway SULS when it compromises the infrastructure safety or operation. A number of site observations well documents railway covering in the literature, e.g. Zhang et al. (2010a); Plaza et al. (2012); Al-Gassim (2013); Cheng et al. (2015).

3.2.2. Track superstructure

Analogously to civil works, track superstructure of at-grade sections (ballast bed, slab or rails) promotes sedimentation of the windblown sand over the track. Windblown sand can jam the railroad switches (also named turnouts, Fig. 9 c). The sand accumulates in the gap between the linked tapering rail and the diverging outer rail (Fig. 9 d), and prevent the correct operation of switches, analogously to snow and ice in cold conditions. In such a condition, service interruption is mandatory since switches malfunction may lead to train derailment or head-on collision.

3.2.3. Rolling stock

The following conditions are recognized as SULSs of rolling stock:

- the sand covering of the railway platform can induce derailment of running trains (Fig. 9 e), as reported by e.g. Nathawat and Sharda (2005), Davel Wallis (2014);

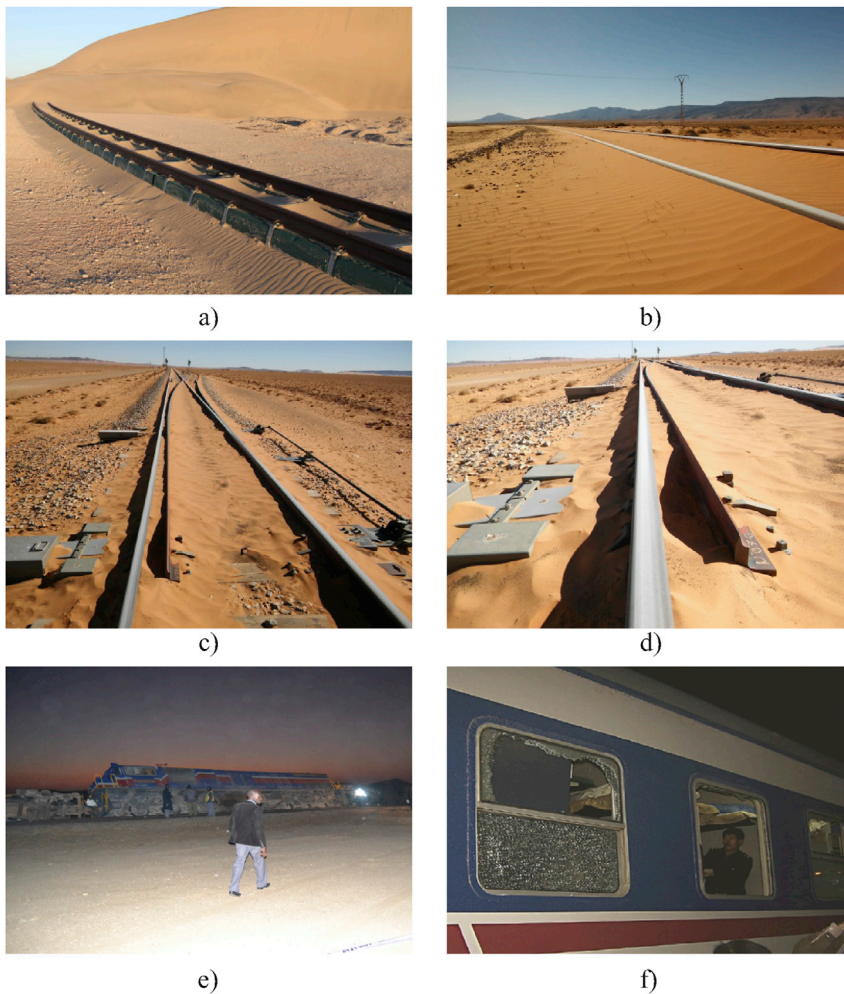

Fig. 9. Sand Ultimate Limit States. Civil works: a) full sand coverage by an encroaching dune (explicit publishing permission from the owner of the photo: Giles Wiggs), b) partial sand coverage blown from sandy plane. Track superstructure: c) jammed turnout, d) detail of the sand accumulation in the gap. Rolling stock: e) running train derailment (reprinted from: Davel Wallis, 2014, with the permission from the editor), f) train window breaking (reprinted from: Cheng et al., 2015; with the permission from Elsevier).

- in general, the overturning of running trains is mainly due to crosswind (see Baker, 2014, for a review). The contribution of the sand suspended in the crosswind flow has been recently studied by Xiong et al. (2011) and Wang et al. (2016, 2017) by means of computational fluid dynamic simulations. According to Wang et al. (2016), for very high crosswind speed (about 50 m/s) the overturning moment caused by sand grains impacts on the running train is about 20% of the aerodynamic overturning moment. To the authors' best knowledge, there are not experimental evidences to date;
- parked trains acting as a further obstacle to windblown sand and promoting sand sedimentation around them. Trains parked even for relatively short time can get trapped during windblown sand events with high sand drift (e.g. one night according to Al-Gassim, 2013). In the mentioned case, sand had to be manually removed to allow the train departure;
- breaking of the train windows by windblown sand in conjunction with high wind speed (Cheng et al., 2015; Fig. 9 f). An experimental study has demonstrated that windblown sand, and especially sand grain of about 5–6 mm in diameter, can significantly reduce the window glass ultimate pressure (Xu et al., 2014).

3.3. Sand Serviceability Limit States

The Sand Serviceability Limit State is attained by every component of the railway infrastructure. Under SSLs, windblown sand affects only a component of the railway. However, SSLs reverberate on the overall railway system performances, notably its speed. Significant speed

reduction along sandy block are reported by Nathawat and Sharda (2005); Zakeri and Forghani (2012); Mohan and Yuanyuan (2010).

3.3.1. Civil works

The sole SSLs attained by civil works is the partial obstruction of railway embankment culverts by the sedimented windblown sand. Even if this is a recurrent issue on the field (Fig. 10 a), it is scarcely studied in scientific literature, except by Shi et al. (2016).

3.3.2. Track superstructure

The following track superstructure SSLs identified:

- ballast contamination (or ballast fouling) due to windblown sand is the most common example of attained track superstructure SSLs. The sand acts as an external source of fine materials (i.e. surface spillage in Selig and Waters, 1994) infiltrating from the upper surface of the ballast bed. In usual conditions, surface spillage contributes to about 7% of the ballast contamination, but it largely prevails in desert environment. Attainment of ballast contamination SSLs is generally defined by referring to a permitted level of fouling, quantitatively expressed by a suitable fouling metric, e.g. Fouling index (Selig and Waters, 1994), Void Contaminant Index (Tennakoon et al., 2012), or Percentage Void Contamination (PVC, Feldman and Nissen, 2002). Different allowable limits of PVC have been applied for different track standards and ballast depths. As an example, according to Indraratna et al. (2011), in a concrete sleeper track with a 250 mm thick ballast, an allowable limit of PVC at 30% is used to specify a ballast-cleaning

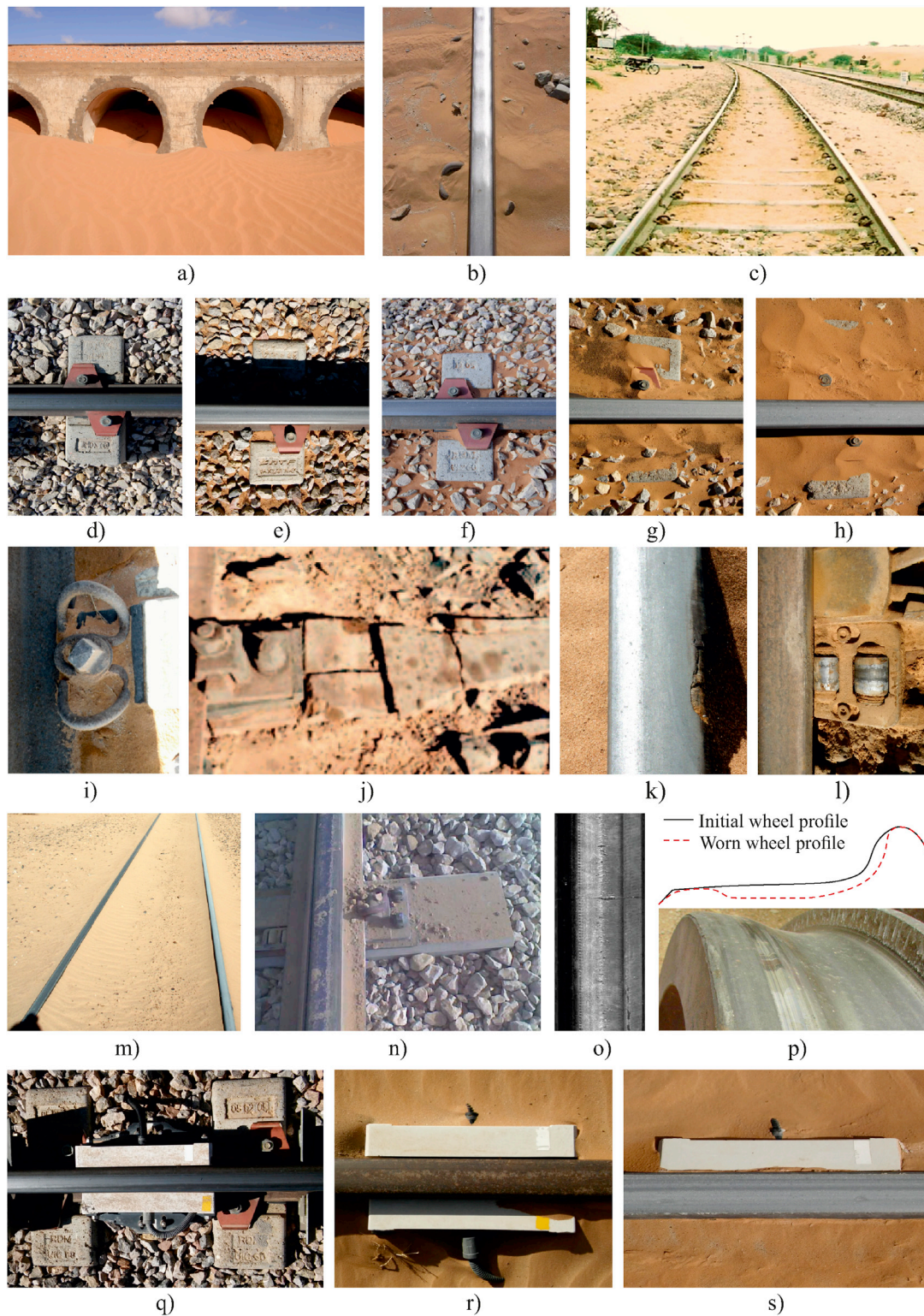

Fig. 10. Sand Serviceability Limit States. a) Partial obstruction of embankment culverts. Ballast contamination induced problems: b) Rail corrugation (reprinted from: Tyfour, 2008, with the permission from Elsevier, photocredit: W. R. Tyfour), c) Track drainage malfunction (reprinted from: Esmaeili et al., 2017, with the permission from Elsevier). d-h) Levels of ballast contamination. Corrosion of track superstructure elements due to salt content in sand: i) contamination of fasteners and rail web, j) degradation of sleepers (reprinted from: Esmaeili et al., 2017, with the permission from Elsevier), k) corrosion of rail head (courtesy of Astaldi). l) contamination of turnout moving components. Sand wearing induced issues: m) thin sand layer on the downwind rail head (incoming wind from left to right, courtesy of Astaldi), n) detail of the downwind rail head (reprinted from: Köllmann, 2013, with the permission from Voestalpine), o) wearing-induced cracks on the rail head (reprinted from: Köllmann, 2013, with the permission from Voestalpine), p) wheel profiling (reprinted from: Köllmann, 2013, with the permission from Voestalpine). Sand accumulation around Wheel Detectors: q) sand free WD, r) partially buried WD, s) fully covered WD.

process considering a minimum requirement for the depth of clean ballast of 100 mm. Fig. 10d–h shows different levels of ballast contamination along the same railway line: clean $0\% \leq \text{PVC} < 20\%$ ballast (Fig. 10 d); moderately ($20\% \leq \text{PVC} < 30\%$) to fouled ($\text{PVC} \geq 30\%$) ballast (Fig. 10 e, f); fully buried ballast (Fig. 10 g); fully covered ballast (Fig. 10 h). In the literature, there is a number of well documented ballast contamination site observations (e.g. Zhang et al., 2010a; Zakeri et al., 2012; Al-Gassim, 2013; Tyfour, 2014). Ballast layer fouling leads to

- increasing of the stiffness and decreasing of the damping of ballast bed and rail support modulus. That causes an increase of train-induced vibrations and additional damage to superstructure components of the track, such as sleepers, rail pads and rails (see e.g. in situ observation by Zakeri et al., 2012 along the Iranian Bafgh-Mashhad railway, and laboratory full-scale box tests by Ionescu et al., 2016). The received share of axle load for under wheel sleeper and sleeper bending moments are subsequently higher in sand-fouled ballast than in clean one (Zakeri and Abbasi, 2012). Ballast fouling percentages of 12% and 50% involve a growth of the rail support modulus of about 182% and 454%, respectively (Esmaeili et al., 2013)
- accumulation of permanent deformation, increasing surface deviation of the track (Ebrahimi and Keene, 2011)
- rail corrugation, as observed in situ by Tyfour (2014) along the Aqaba Railway, Jordan (Fig. 10 b). This is a phenomenon characterized by route-wise periodic patterns of wavelets on the rail head (Tyfour, 2008). Besides negatively affecting train induced dynamics, such anomalies also result in environmental noise pollution. Affected rails are called squealing or roaring (Mandula et al., 2000);
- decreasing of the ballast drainage capacity, as observed in situ by Anurag (2008) (Fig. 10 c). The test results by Tennakoon et al. (2012) show that a 5% increase of the Void Contaminant Index decreases the hydraulic conductivity by a factor of around 1500 for ballast contaminated by fine clayey sand;
- corrosion and degradation of fastening system, r. c. sleeper and rail due to the salt content of the sand sedimented around them (Fig. 10 i, j and k, respectively). To our best knowledge, no specific studies about windblown desert sand are published on the topic, apart from qualitative observations of corrosion test in a saline mist chamber on a specially coated clip and its metallic screw (Carrascal et al., 2016)
- sand induced effects on the dynamic behaviour of fastening systems. Laboratory dynamic bending load tests conducted by Carrascal et al. (2016) on a single fastening system show that sand penetrates in the gaps between the upper surface of the pad and the rail foot. A significant increase of the overall stiffness of the fastening system follows (about +44%)
- windblown sand sedimented around railroad switches enters and becomes trapped in their components. This, in turn, leads to abrasive wear (Woldman et al., 2012), increasing of the friction between sliding/rolling components (Fig. 10 l), decreasing of the performance and durability of grease and lubricant (Köllmann, 2013);
- rail grinding induced by the thin sand layer sedimented on the wheel-rail contact interface. This SSLS has been first recognized along the heavy-haul North-South Railway in KSA (Al-Gassim, 2013; Köllmann, 2013; Hewitt, 2015), and more recently along the Haramain High Speed railway (Faccoli et al., 2018). The thickness of the sand layer on the head of the rail is estimated of the order of the millimeter. The sand covered rail head is easily recognizable by its matte surface, compared to the shiny sand free rail head (e.g. the right and left hand rails in Fig. 10 m, respectively). When a train travels on a rail covered by a thin sandy layer, it crushes sand grains and increases wearing (Fig. 10 n). To our best knowledge, the reasons why sand sediments on a rail head are scarcely investigated in scientific literature. Hewitt (2015) conjectures this is due to the aerodynamic effects of the passing trains: the underside of the vehicle induces lifting of the sand

previously sedimented in between rails, analogously to the well known ballast lifting by high speed trains. Analogous effects are expected in the wake of the train. These train-induced lifting is expected to induce the sand covering of both rails, because related aerodynamic phenomena are symmetric in average. However, in situ observations (e.g. Al-Gassim, 2013) often reveal the asymmetric sand covering of the rails, i.e. covered downwind and sand-free upwind rail head (e.g. Fig. 10 m). We propose in the following an aerodynamic reading of this evidence. The incoming wind flow separates at the head of the upwind rail. Here, the flow acceleration avoids sand sedimentation and promotes erosion. Conversely, the low-speed flow recirculation in the track gauge promotes the windblown sand sedimentation around the downwind rail gauge face and on its head. This qualitative reading should be confirmed by future quantitative studies. The sandy layer increases the friction coefficient up to approximately twice the value commonly seen in Europe or North America (Hewitt, 2015). This induces adhesive vertical and gauge face wearing rates 18 to 24 times higher than an analogous North American railway (Hewitt, 2015). A worn rail head with crack patterns on its surface is shown in Fig. 10 (o). Because of the asymmetric sand sedimentation, Al-Gassim (2013) estimates the head of the downwind rail wears at 2–3 times the rate of the upwind rail, and the rate of rail replacement is expected 3 to 1 for the downwind to upwind rail respectively.

3.3.3. Rolling stock

The rolling stock may attain the following SSLs:

- sand-induced wheel profiling results from the same aerodynamic phenomenon that induces rail grinding (Subsect. 3.3.2), i.e. wind-blown sand sedimentation on the wheel-rail contact interface. Severe wheel wear problems have been observed on rolling stock operating along the heavy-haul North-South Railway in KSA (Al-Gassim, 2013; Köllmann, 2013; Hewitt, 2015) and along the Haramain High Speed railway (Faccoli et al., 2018). The wheels adopted in four months track test along the Haramain line recorded very low performances in terms of durability, reaching the end of life within around 130,000 km (Faccoli et al., 2018). Analogously, Al-Gassim (2013) estimates that the wheel wears 2–3 times faster than the normal rate, and wheel replacement is 2–3 times more frequent. Both flange wear and hollow wheel occur (Fig. 10 p, after Köllmann, 2013). According to Hewitt (2015), the wearing process is amplified along almost completely tangent alignments usually occurring in railway lines across deserts. Here, the wheel running bands consistently makes contact with the same portion of the rail profile;
- sand impact on high-speed running trains. Premature wear of train elements, especially the leading vehicle, may occur because of the high relative speed caused by the motion of high-speed trains in sand-laden air. Such a limit state has not been observed up to now in the field, but preliminary investigations have been recently proposed in the literature by Paz et al. (2015).

3.3.4. Signalling system

A number of signalling devices are often mounted on modern railways to detect and transmit rolling stock information. All of them are prone to be buried by sedimented sand, and damaged by mechanical sand removal operations. Conversely, sedimented sand is expected to affect their operability to a different extent, depending on their working principles. Even if to our best knowledge scientific studies or technical specifications are not available in the literature, some devices are recalled in the following:

- Wheel Detectors (WDs) are part of Axle Counting System, rail-mounted on the gauge side of the rail, and usually based on inductive sensor technology. Such sensors are traditionally (Futsuhara and Mukaidono, 1989) and widely used to measure train position or speed

in desert environments. Because of their working principles, they are generally independent of sedimented sand (Howard, 2013). Sand free, partially buried and fully covered WDs are shown in Fig. 10q–s, respectively;

- balises are wayside transmission units which communicate with a train passing over them. They are mounted along the center line of the track, and based on Magnetic Transponder Technology. Its main function is to transmit and/or receive signals through the air gap between the balise and the train (UNISIG, 2012). The sand covering induces the impairment in the balise performance, analogously to other debris (Thake, 2012). The European mandatory requirements for achieving air-gap interoperability specify detailed functional and non-functional requirements for the balise and consider specific environmental conditions (UNISIG, 2012). In particular, balise must fulfill the Input/Output characteristics when applying a 20 mm thick dry sand covering. In our opinion, for the time being, such a thickness can be tentatively adopted to quantify the SSLs of balises;
- Hot box and hot wheel defect detectors are mounted across the whole gauge, and based on infrared optics. Their working principle is expected to be strongly affected by sedimented sand covering. The following partial remarks can be synthetically drawn about Sand Limit States:
 - bearing in mind the magnitude of the incoming windblown sand drift defined above, and the length and lifetime of a railway line, its verification at both SULS and SSLS can be obtained only under planned maintenance operation of the sand mitigation measures and of the railway itself;
 - the verification of the railway line and its components at SULS is mandatory in order to cope with safety issues;
 - the undesired effects at SSLS can be mitigated, but not completely removed.

4. Windblown Sand Mitigation Measures

Effective, durable, robust and sustainable Sand Mitigation Measures (SMMs) are mandatory in order to satisfy the conditions at both SULS and SSLS defined above. In the reviewed literature, there is a number of SMMs proposed in the past, notably in the last decade. Their rationale collection is needed in order to orient railway owners, designers, general contractors and railway operators among the available technical solutions.

4.1. SMM categorization criteria in the literature

Historically, the first SMMs categorization attempt has been made by Rahim (1945). In his pioneering survey, Rahim proposes an early categorization of “*methods adopted from time to time to deal with the evil [windblown sand Ed.]*”. Rahim’s classification is driven by two ordering criteria: space-extent and time-length. The first criterion allows distinguishing between: i. country-wide measures (i.e. “*to eradicate the evil from the country as a whole by a coordinated effort between various department like Forest, Irrigation, Road and Railways*”); and ii. narrow-strip measures (i.e. “*arresting the onslaught of the sand dunes on to the railway track [...] in the narrow strip of the land belonging to the railway*”). The first group, also called “*reclamation of the sand drifts*” analogous to “*solutions against desertification*” in the current language, is no further articulated by Rahim. Conversely, the time-length criterion is further applied to the narrow-strip SMMs, so that permanent, semi-permanent and temporary SMMs are sorted by decreasing initial cost and increasing maintenance frequency and related costs. The Rahim’s time-length categorization has been somewhat recently revised by Zakeri (2012), who refers to short-term and long-term approaches to the windblown sand challenges. A different kind of categorization is objective-based. Kerr and Nigra (1951, 1952) firstly applied this approach to SMMs adopted for oil-field operations, and selected four objectives: i. Destruction or stabilization of sand dunes; ii. Diversion of wind-blown sand; ii. Direct and permanent

stoppage or impounding of sand before the object to be protected; iv. Rendition of deliberate aid to sand movement so as to avoid deposition over the object. Analogously, Watson (1985) adopted four other objectives: i. Enhancement of the deposition of entrained sand; ii. Enhancement of the transportation of sand; iii. Reduction of the sand supply; iv. Deflection of the moving sand. Cheng and Xue (2014) have recently proposed an objective-driven classification with reference to the SMMs employed along the Qinghai-Tibet railway: i. Sand-resistance engineering measure; ii. Sand-stabilization engineering measure; iii. Sand-guidance engineering measure. Finally, it is worth citing the somewhat hybrid categorization proposed by Stipho (1992), resulting in three categories: i. Protection management; ii. Stabilization management; iii. Land management. In our opinion, each criterion has its pros and cons. The space-extent and time-length based categorizations are technically sound, because they lie in the design dimensions, but they fail in guaranteeing the categorization uniqueness: a single kind of SMM (e.g. straw checkerboard) can belong to both country-wide measures and narrow-strip ones, while the time-length of a SMM (e.g. a sand trapping ditch) strongly depends on its capacity (e.g. its size). The objective-based categorization are directly informative once the design goals are fixed, but once more, it does not guarantee the categorization uniqueness: the same SMM (e.g. a porous fence) can be adopted to reach multiple objectives (e.g. enhancement of the deposition of entrained sand, reduction of the sand supply, deflection of the moving sand in Watson, 1985). Furthermore, such a categorization is not directly defining the SMM spatial location.

4.2. SMM categorization: a new proposal

In the following, we propose a new categorization of the SMMs for railways with the goal of partially contributing in overcoming the previously mentioned shortcomings. The categorization criterion follows the SMM location with respect to the sand course. An innovative Source-Path-Receiver (SPR) scheme results (see Fig. 11):

- 1 *Source* SMMs are directly located over the sand source (dunes or loose sand sheets), whatever the spacing between the sand source and the infrastructure is. They are almost independent from the type of infrastructure.
- 2 *Path* SMMs are located along the windblown sand path ranging from the sand source to the infrastructure. They depend on the overall geometry of the infrastructure, e.g. point-wise or line-like infrastructure components.
- 3 *Receiver* SMMs are directly located on the infrastructure (e.g. the railroad or its shoulder). As a result, they strongly depend on the type of the infrastructure.

SPR categorization can be complemented by the recognized SMM working principles from the reviewed literature: i. Sand-modifying, where the mitigation is achieved by modifying the properties of sand; ii. Aerodynamic, where the mitigation is carried out by changing the local wind flow; iii. Sand-resistant, where the mitigation is achieved by improving the material properties of the infrastructure component to be protected. Such major differences in the working principles results from the multidisciplinary in windblown sand mitigation. In this overview, the focus is put on the aerodynamic-based SMMs. It is also worth pointing out that SPR categorization is consistent with a complementary criterion based on the windblown sand moving processes. The windblown sand movement is described by the three main processes: Erosion, Transport, and Sedimentation (ETS, e.g. Preziosi et al., 2015). Sand-modifying and Aerodynamic SMMs aim at controlling, promoting and/or preventing such processes. Table 1 shows the correlation between SPR classification and ETS processes.

The working principle of source SMMs is mainly based on preventing sand source Erosion. Path SMMs aim at controlling sand Transport by driving the wind flow and/or at promoting sand Sedimentation around

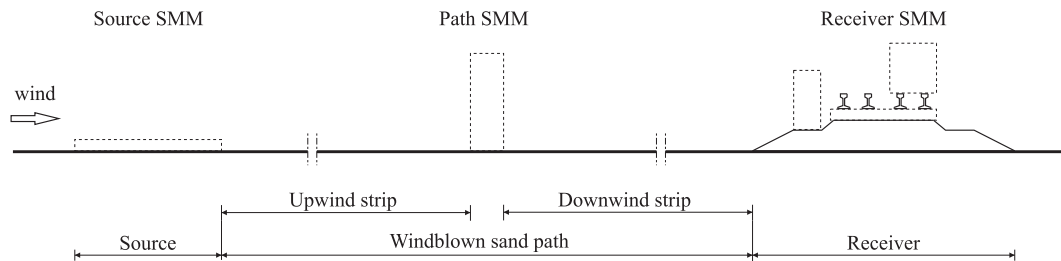

Fig. 11. Conceptual scheme of the Source, Path and Receiver SMM classification.

Table 1
Correlation between types of mitigation measure and sand moving processes.

	1. Source	2. Path	3. Receiver
Erosion	Prevented		Promoted
Transport		Controlled	Controlled
Sedimentation		Promoted	

them along the windblown sand path. Receiver SMMs are applied to control the Transport of windblown sand by deflecting it from the infrastructure, and/or by promoting the Erosion of the sedimented sand.

Finally, it is worth anticipating that the proposed SPR scheme corresponds to the Sand Limit States introduced in Section 3. Correlation between SPR classification and SLSs is shown in Table 2.

Source and Path SMMs are mainly addressed to mitigate massive sand erosion and transport upwind the infrastructure, i.e. reducing the sand flux responsible for SULS. However, even if such SMMs exhibit high sand trapping performance, it is not likely that they completely trap the whole incoming windblown sand and cope with SSLs. Receiver SMMs definitely cope with SSLs once the Path and Source SMMs remove the threat of SULS. Aerodynamic receiver SMMs are addressed to avoid the local sedimentation on the railway body of small amount of sand filtered by Source and Path SMMs. Sand-resistant receiver SMMs are ad-hoc modified track superstructure components characterized by increased sand resistance, i.e. increased lifetime.

Bearing in mind the matching of the SPR categorization with ETS and SLSs, the proposed classification also offers a new rationale to the combined use of complementary SMMs, as recently proposed by other authors (e.g. in Cheng and Xue, 2014; Xie et al., 2015; Cheng et al., 2016a, b). It is, however, worth to be stressed that the proposed SPR categorization does not necessarily cover any potential sand mitigation strategy that can be imagined. Fig. 12 shows the synoptic scheme of the proposed categorization, and anticipates the sub-categories reviewed in the following.

4.3. Source SMM

Source SMMs aim at reducing incoming windblown sand flux by: i. reducing erosion from localized sand sources (e.g. sand dunes) and/or smeared sources (e.g. loose sand sheets); ii. stopping mobile dunes, such as marching (e.g. barchans dunes) or unstable dunes, (e.g. transverse dunes evolving in barchanoid chains). Such measures have been mainly developed and applied in International (Longjun, 2011) and National (e.g. Stigter et al., 2002; Wang et al., 2010; Bellefontaine et al., 2012; Saifi et al., 2015) Country-wide systematic actions against desertification. In this perspective, the 10-km-wide green belts are by far wider than the railway corridor, and its objectives are beyond the funding

Table 2
Correlation between types of mitigation measure and Sand Limit States.

	1. Source	2. Path	3. Receiver
SULS	✓	✓	
SSLs			✓

capabilities and the scope of the railway promoters. At a smaller scale, such measures have been also applied in tens-of-meter-wide areas to control small dune fields, single dunes or loose sand sheet in the infrastructure corridor (e.g. Alghamdi and Al-Kahtani, 2005; Liu et al., 2011; Cheng and Xue, 2014). In the following, desertification literature is referenced regarding the technique categorization, while engineering bibliographic references are given for infrastructure applications. The approach usually involves short-term, temporary stabilization of the sand surface, followed by progressive, long-term, permanent stabilization by means of vegetational covering. Source SMMs can be further divided into Layer systems (Ben Salem, 1985, also called mulching techniques), and Hedge systems (Kaul, 1985), on the basis of their working principle.

4.3.1. Layer system

The idea behind the *layer system* derives from the nature, where it was observed that the sand layer is prone to crusting. Fig. 13 (a) shows a naturally crusted surface of sand. The crusting phenomenon relies on increasing of cohesive forces between sand grains, consequently increasing the erosion threshold u_{*t} by cementing the sand surface. In such a way, the incoming sand flux is reduced according to Eq. (1). The moisture content of dry sand is approximately 0.2 – 0.6% depending on the moisture of the surrounding atmosphere. When a sand layer is wet, moisture is retained by sand as a surface film. Thus, cohesion results from tensile forces between water molecules and sand grains. A content of moisture above 4% fully inhibits sand grain movement, at least under the incoming wind speed tested in wind tunnel experiments by Belly (1964) and Johnson (1965). Salt in low concentrations can significantly raise the erosion threshold, even without increased content of moisture. Salt and other cementing agents act as cement at points of grain contacts. The cementing effect can be achieved by artificially increasing the moisture content or other cementing agents like salt, clay skins, fungal hyphae, algae and lichens (Pye and Tsoar, 2009). According to the material used, layer SMMs can be divided into: i. natural material layers, such as soil, salty water, biological crust; ii. oil-based layers, such as asphalt (e.g. Watson, 1985; Asi et al., 2002, see Fig. 13 b), high gravity waxy oil, crude oil (e.g. applied for industrial facilities and pipelines, Alghamdi and Al-Kahtani, 2005); ii. layers made of chemical products (e.g. applied for line-like transport infrastructures, Terratech, 2010; Shuraa, 2014). Besides the growth of erosion resistance they induce, materials applied in layer SMMs should satisfy other industrial criteria, such as durability, rain water solubility, cost, environmental effects and in-situ availability being the most important ones. In the example of asphalt-latex mixture used as a layer SMM shown in Fig. 13 (b), the mixture is laid using a pressure injection technique which achieves penetration up to 28 mm. The penetration depth is an important parameter in order to avoid the destruction of the layer due to dune movement. For a thicknesses lower than 10 mm, dune movement causes the collapse of the treated surface making the SMM ineffective (Watson, 1985).

4.3.2. Hedge system

The *hedge system* involves discontinuous, closely spaced obstacles placed on the ground to increase its aerodynamic roughness (z_0), and to locally reduce in turn the shear stress at the wind-sand interface. Indeed,

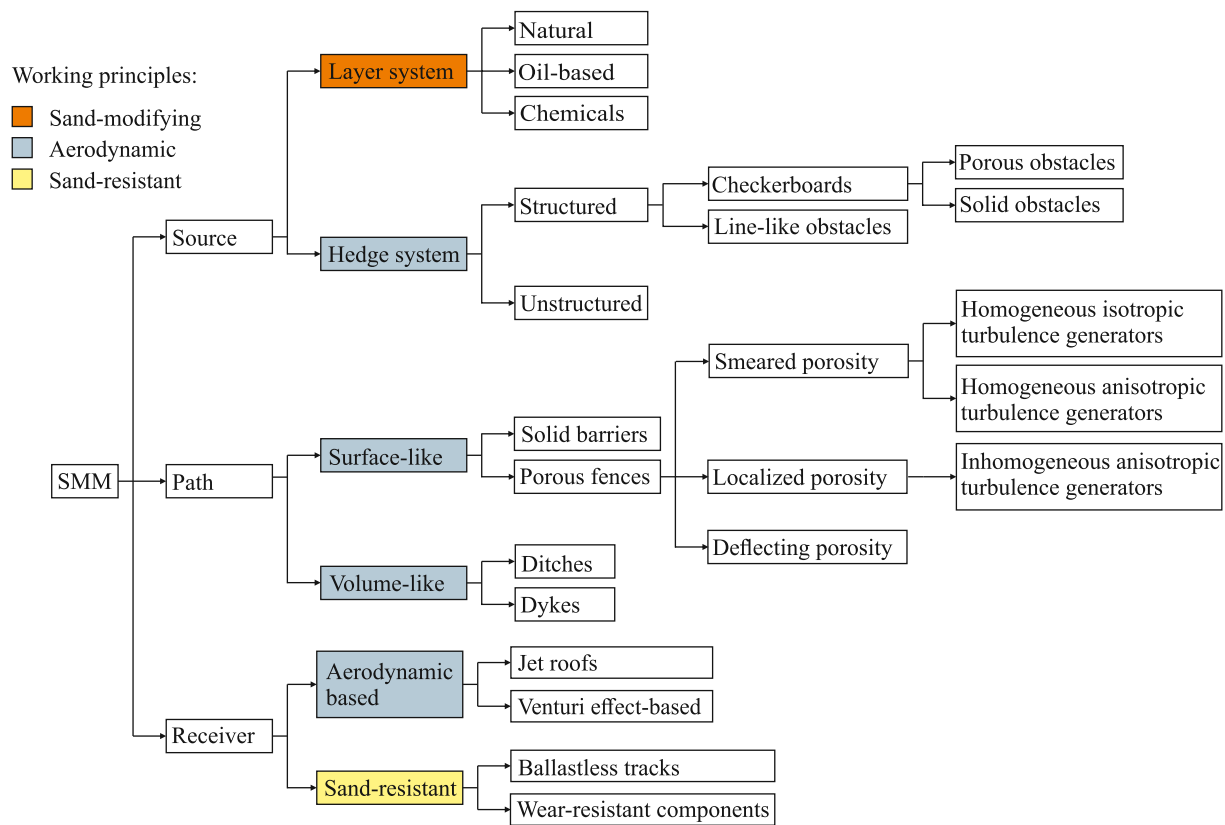

Fig. 12. Scheme of the proposed SMM categorization.

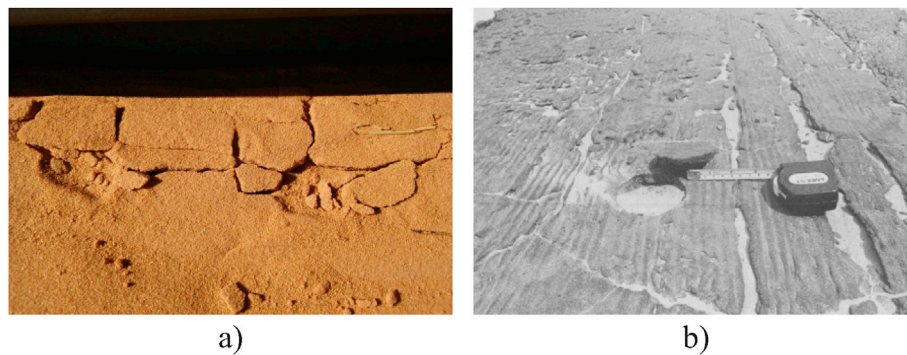

Fig. 13. Layer system. a) Natural sand crusting, b) asphalt-latex mixture layer (reprinted from: Watson, 1985, with the permission to reuse under a Creative Commons Attribution License).

a decrease in wind shear stress leads to a reduction of the sand transport rate (see Eq. (1)). Obstacles could be arranged in a regular or irregular pattern, resulting in two hedge sub-categories: Structured hedge system, and Unstructured hedge system, respectively.

Structured hedge solutions can be in turn divided into pointwise obstacles and checkerboard systems. Some examples of pointwise obstacles as an SMM are reported in Gillies et al. (2006); Gillies and Lancaster (2013). The checkerboard solution (Fig. 14 a–c) is the most widely adopted structured hedge system, since the early field tests along the Baotou-Lanzhou railway in the 1950s (Liu, 1987). Small obstacles are usually manually arranged in an orthogonal and equally spaced alignments, resulting in square cells. About half of the obstacle is buried in the sand, while the other half is above the ground level and exposed to the wind. An SMM example similar to the checkerboard system is shown in Fig. 14 (d). A structured array of line-like obstacles is arranged

orthogonally to the prevailing wind direction. As a result, it is only effective along the orthogonal direction. Several materials are used depending on the in-situ availability, and according to this criterion structured hedge system can be further divided in:

- 1 porous obstacles, built from straw (Fig. 14 a, Yu Qiu et al., 2004), reed (Dong et al., 2004), polyethylene-net (Fig. 14b and Cheng and Xue, 2014), and coconut leaves (Fig. 14 d, Lima et al., 2017);
- 2 solid obstacles, e.g. stones (Fig. 14 c, Zhang et al., 2010a).

The checkerboard system aerodynamic working principle is qualitatively shown in Fig. 15. Generally speaking, the flow regime inside a cavity (i.e. the checkerboard cell) mostly depends on the aspect ratio ($AR = w/h$, Oke, 1987). As a result, three characteristic flow regimes are defined (Bernardino et al., 2015): i.) Skimming flow ($AR \leq 1.5$), where



Fig. 14. Structured Hedge system: a) straw checkerboard (reprinted from: Guo et al., 2014, with the permission to reuse under a Creative Commons Attribution License), b) polyethylene-net checkerboard (reprinted from: Zhang et al., 2010a, with the permission from Elsevier), c) stones checkerboard (reprinted from: Zhang et al., 2010a, with the permission from Elsevier), d) array of line-like obstacles (reprinted from: Lima et al., 2017, with the permission to reuse under a Creative Commons Attribution License).

only a single vortex appears inside of a cavity; ii.) Wake interference flow ($1.5 \leq AR \leq 2.5$), where the main vortex is significantly shifted downwind and a stable secondary counter rotating vortex appears; ii.) Isolated flow ($AR > 2.5$), where the flow is qualitatively similar to the flow around an isolated obstacle, i.e. a large vortex appears downwind an obstacle before the flow reattachment point, and recirculates again in front of a downwind obstacle. In real world applications along railways, the cell side length usually varies from 1 to 3 m, and the exposed height is from 10 to 30 cm respectively, resulting in an $AR \approx 10$. Hence, the flow inside the cell should correspond to the isolated flow regime. Fig. 15 (a) shows the conjectured flow regime for an array of cells bounded by solid obstacles.

Recirculating vortices drain energy from the incoming wind flow, by reducing the mean wind velocity. The reduction of wind velocity near the ground can be accounted for via the increase of the aerodynamic roughness to about 0.015 m, i.e. about 1000 time greater than the one of a flat sandy surface. The sand level evolution inside a cell is qualitatively given in Fig. 15 (b). The arrow crossing the sand levels depicts the trend of the sedimentation process. Fig. 15 (b) is complemented by Fig. 15 (c), (d) and (e), where some real world examples of the sand level inside cells are shown. The two vortices inside the initially empty cell promote sand sedimentation close to the inner side of the obstacles (see Fig. 15 c). At equilibrium between erosion and sedimentation, two different stable conditions result in the cell, differently reducing wind velocities (Qu et al., 2007): i. a concave sand surface with a ratio of the cell length and sand-free height ranging between 1:10 and 1:8 (see Fig. 15 d). In this configuration, the SMM is working properly and is preventing further erosion. ii. A flat sand surface at the top of the exposed part (see Fig. 15 e). When the checkerboard is completely buried by sand, it is unable to

further promote sand sedimentation and it becomes a sand source in turn. As a result, manual sand removal maintenance is required. Alternatively, vegetation growth may be promoted inside the cells, once the sand inhibits most of the cell volume. Since the evaporation rate is inversely proportional to the aerodynamic roughness (Davarzani et al., 2014), the adoption of checkerboards allows for an increment in sand bed moisture retaining and in turn to the promotion of vegetation growth. Despite the number of scientific studies devoted to the topic of the sand sedimentation around checkerboard system (for a recent review, see Lihui et al., 2015), the critical values of the full set of parameters inducing the transition from the favorable (i) to the unfavorable equilibrium condition (ii) are still not clearly defined.

Unstructured hedge solutions are often employed in the form of gravels spread on the sandy surface (Fig. 16 a). However, attention should be paid regarding both the gravels size and the covering ratio since they can be buried by sand leading to an increment in the sand source (Liu et al., 2011). Irregular vegetation pattern could be also ascribed to this subcategory. Gillies et al. (2015) attempts to mimic a natural vegetation pattern by arranging large-size roughness elements, such as straw bales (Fig. 16 b). Since they do not require water for their maintenance, they could be preferred to plant-based SMMs where it is not available. Permanent stabilization of sand is possible with an artificial vegetation layer upwind the infrastructure planned to be protected. However, attempts of vegetative stabilization should consider the inter-relationships between several physical and biological habitation factors, most important one being the quantity of available water. A vegetation system around a single oasis takes the form of shelterbelts. For more details, the interested readers are referred to the recent in situ

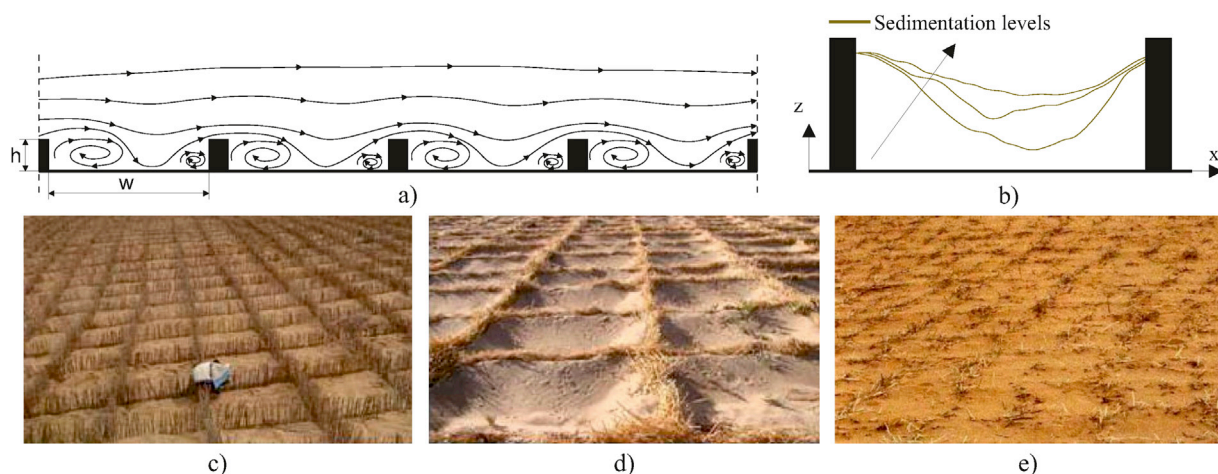

Fig. 15. Checkerboard Hedge system: a) Isolated flow regime inside cells (cells geometry scale: $Dz \approx 2Dx$), b) corresponding qualitative sedimentation levels in a cell (redrawn from: Lihui et al., 2015, sand sedimentation levels scale: $Dz \approx 6Dx$), c) initial unstable condition of empty cells (reprinted from: Guo et al., 2014, with the permission to reuse under a Creative Commons Attribution License), d) stable concave surface (reprinted from: Guo et al., 2014, with the permission to reuse under a Creative Commons Attribution License), e) stable flat surface (reprinted from: Qu et al., 2007, with the permission from Elsevier).



Fig. 16. Unstructured Hedge system: a) gravel surface (reprinted from: Liu et al., 2011, with the permission from Elsevier), b) large roughness elements (reprinted from: Gillies et al., 2015, with the permission from Elsevier), c) trees planted over dunes near a railway.

observation at the Minqin oasis, Badai Jaran Desert and Tengger Desert (in Gansu Province, Ma et al., 2010). A vegetation system along line-like infrastructures takes the form of upwind and downwind vegetation belts. To our best knowledge, this vegetation solution has been adopted, in the recent past, along the Jing-Tong Railway (Kangfu et al., 1989) and the Tarim Desert Highway crossing the Taklamakan Desert (Dong et al., 2004). An example is shown in Fig. 16 (c).

4.4. Path SMM

The goal of Path SMMs is the promotion of sand sedimentation, achieved by controlling windblown sand transport, i.e. by driving the local wind flow in turn. The wind flow is modified by reducing the longitudinal component of its velocity and/or by promoting the wind flow recirculation. Due to the amount and variety of Path SMMs proposed in the literature, we further divide them into two subcategories, according to a geometric criterion:

- 1 Above-ground Surface-like SMMs, i.e. solid barriers and porous fences (Fig. 17 a,b);
- 2 Volume-like SMMs, i.e. ditches, dikes and ridges (Fig. 17 c,d,e).

It is worth stressing that such a classification is also compliant with the sedimentation mechanism they induce. Surface-like SMMs promote sedimentation along the upwind and/or downwind strips (see Fig. 11), while volume-like SMMs allow sand sedimentation also over and/or inside them. Whatever the geometry of Path SMMs is, they can be arranged in two main configurations, as shown in Fig. 18. Both the configurations tend to preserve the angle of attack $\alpha = 90^\circ$ between the direction of the prevailing wind and the SMM longitudinal axis. In the case of skewed wind with respect to the railway longitudinal axis, ($\theta \neq 90^\circ$, as shown in Fig. 18 b), the SMM modules are slanted and their tips overlapped alongwind.

Since the current state of the art does not allow a comparative and comprehensive quantitative assessments of every Path SMM, qualitative schemes representing the morphodynamics of sand accumulation are provided in the following subsections.

4.4.1. Surface-like

The optical porosity β is the degree of permeability of a surface-like SMM, i.e. the percentage ratio of the open area to the total area (Lee and Kim, 1999). It is commonly considered the most important parameter controlling the performances of straight vertical surface-like SMMs of a given height and for a given incoming wind. Based on that, surface-like SMMs can be further divided into two main categories:

- 1 Porous fences, if $\beta > 0$;
- 2 Solid barriers, if $\beta = 0$.

Porous fences have been widely investigated in the scientific literature since the early aerodynamic studies at the beginning of the 20th century (e.g. Bates, 1911), and the pioneering applications to control windblown snow (e.g. Finney, 1934) and sand (e.g. McLaughlin and Brown, 1942). The research activity about fences has been recently reviewed with respect to both wind loads (Giannoulis et al., 2012), aerodynamics (Hong et al., 2015), and induced morphodynamics (Li and Sherman, 2015; Wang et al., 2018). Conversely, to our best knowledge, scientific studies on solid barriers are surprisingly scarce, and usually limited to the aerodynamics (e.g. Baines, 1963; Good and Joubert, 1968; Letchford and Holmes, 1994) and sand morphodynamics (e.g. Hotta and Horikawa, 1991; Cornelis and Gabriels, 2005) of Straight Vertical Walls (SVWs). In the following, straight vertical surface-like SMMs are reviewed first, and solid SVWs are viewed as a limit term of reference to porous fences. Secondly, solid barriers with shapes other than straight vertical plane are scrutinized.

Fig. 19 collects results from a number of experimental studies in order

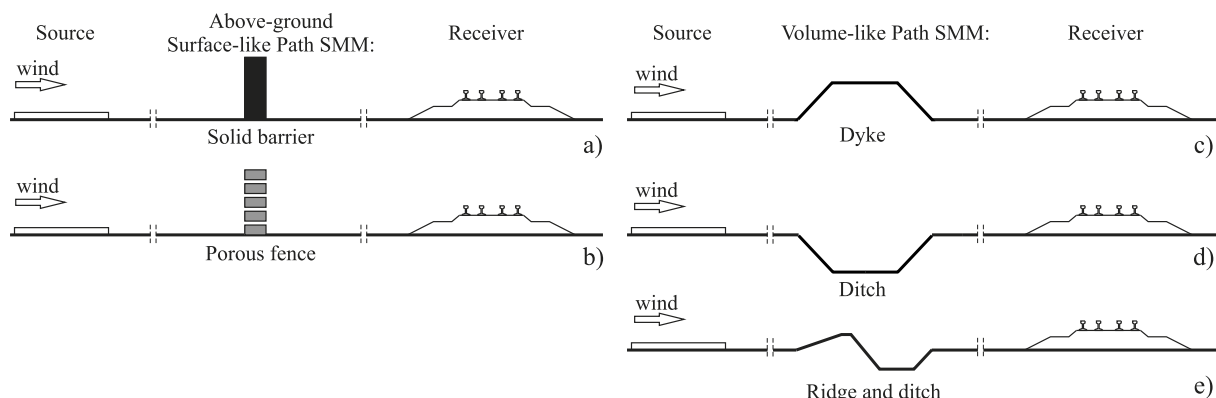

Fig. 17. Path SMMs: surface-like (a,b), volume-like (c,d,e).

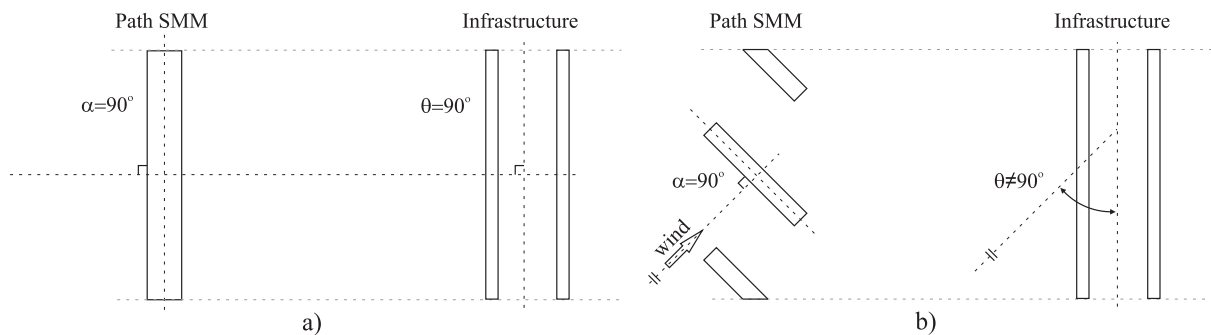

Fig. 18. Path SMM arrangement configurations: a) wind direction orthogonal to the longitudinal railway axis, b) skewed wind direction.

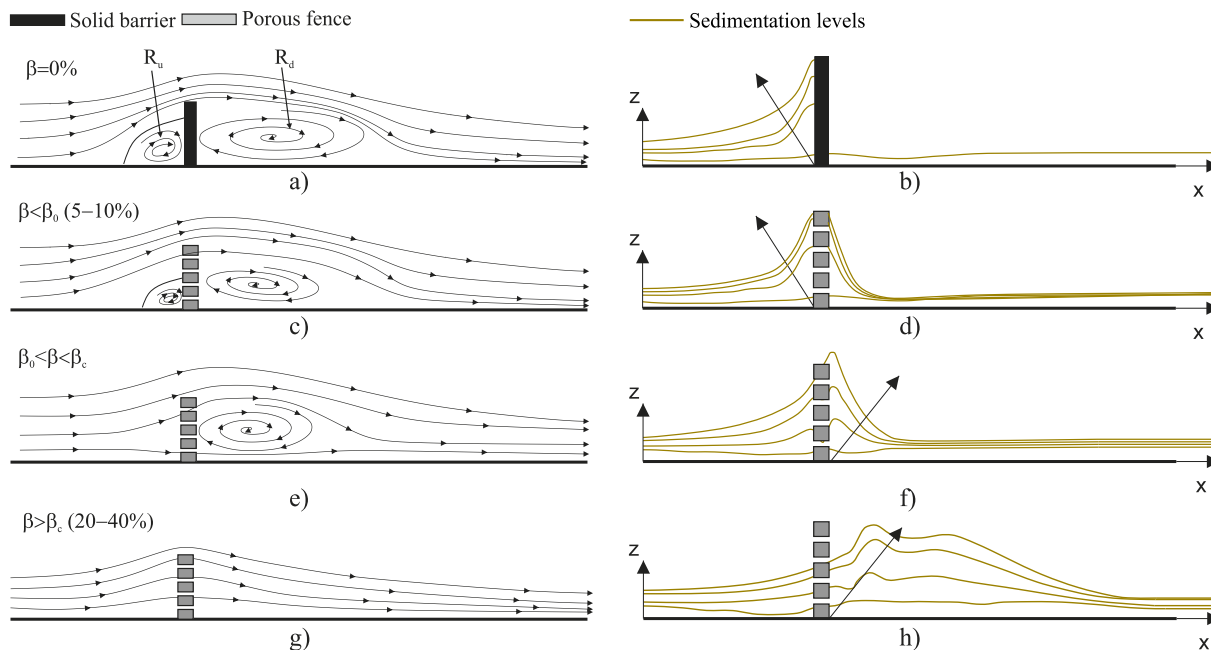

Fig. 19. Wind flow mean streamlines and related sedimentation levels around: (a,b) solid SVW barriers (redrawn from: Baines, 1963; Hotta and Horikawa, 1991), (c, d) very low porosity fences ($\beta < \beta_0$, redrawn from: Dong et al., 2007; Hotta and Horikawa, 1991), (e,f) low porosity fences ($\beta_0 < \beta < \beta_c$, redrawn from: Xu and Mustafa, 2014.; Hotta and Horikawa, 1991), (g,h) high porosity fences ($\beta > \beta_c$, redrawn from: Xu and Mustafa, 2014.; Hotta and Horikawa, 1991). Sand sedimentation levels scale: $Dz = 5Dx$.

to describe the evolution of both the wind pattern and the sand sedimentation process versus the porosity ratio. The wind pattern around null porosity SVW barriers (Fig. 19a and Baines, 1963) is characterized by a large reversed flow region in the wake of the barrier (R_d) and by a stable clockwise vortex upwind the barrier (R_u) below the stagnation point. R_u reduces the wind shear stress close to the ground and promotes upwind sand sedimentation in turn (Fig. 19 b, Hotta and Horikawa, 1991), acting as a sand trapping vortex. As a result, the larger the upwind vortex, the higher the upwind sand accumulation potential, i.e. the maximum amount of trapped sand volume (see Bruno et al., 2018a, for further details). An increment of the porosity (Fig. 19c and Dong et al., 2007) induces the shrinking of the stable clockwise vortex R_u . The watershed value $\beta_0 \approx 5 - 10\%$ is defined as the one at which R_u vanishes. Given the non-null porosity, sand sedimentation occurs on both sides of the fence with a downwind steep slope (Fig. 19 d, Hotta and Horikawa, 1991). However, most of the sedimentation still occurs upwind the fence. A further increment of the porosity induces the growth of R_d (Fig. 19 e, Xu and Mustafa, 2014.). This occurs in the interval $\beta_0 < \beta < \beta_c$, where β_c is defined as the porosity value at which the reversed flow region in the wake of the barrier R_d vanishes, too. Most of the sedimentation occurs downwind the fence and the downwind slope is more shallow (Fig. 19 f, Hotta and Horikawa, 1991). For values of β greater than the critical value

$\beta_c \approx 20 - 40\%$ (Li and Sherman, 2015, and related references), the flow is dominated by the bleed flow through the fence openings (Fig. 19 g, Xu and Mustafa, 2014.). Sand sedimentation is no longer induced by the reversed flow downwind the fence, but simply by the velocity defect in its wake (Fig. 19 h, Hotta and Horikawa, 1991). The porosity $\beta_{opt} \approx 40 - 50\%$ is widely established as optimal value in terms of sand trapping overall efficiency (Savage and Woodhouse, 1968; Bofah and Al-Hinai, 1986), defined as the maximum volume of accumulated sand per fence unit length, irrespectively of where sedimentation occur. Fences with β higher than 50% are rarely used, because of their low sand trapping efficiency (Hotta and Horikawa, 1991).

The variability of the values of β_0 , β_c and β_{opt} testify that the porosity ratio, i.e. a macroscopic feature, cannot summarize all the relevant parameters that drive the aerodynamic and sand morphodynamics of porous fences. Besides the porosity ratio, sand sedimentation depends on a number of other parameters. Some of them are not directly related to the SMM (e.g. environmental and experimental setup, related incoming wind conditions, measurement uncertainties), while others are related to SMM microscopic features, such as size, shape, distribution and orientation of openings and solid elements (Li and Sherman, 2015). Based on that, we propose to schematically divide porous fences into three sub-categories: i.) Fences with smeared porosity; ii.) Fences with localized

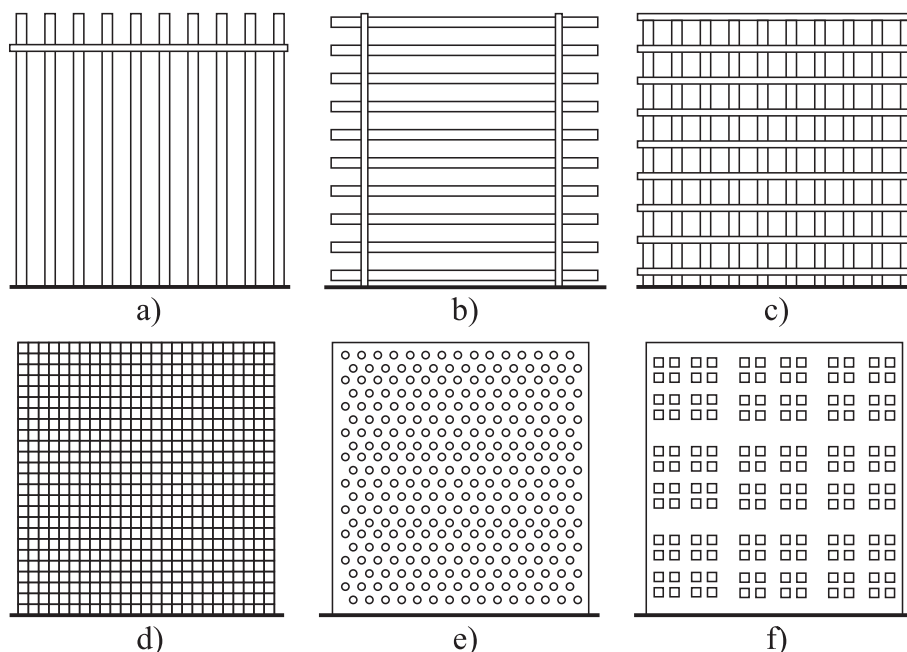

Fig. 20. Fences with smeared porosity. Homogeneous anisotropic turbulence generators: a) vertical slats, b) horizontal slats. Homogeneous isotropic turbulence generators: c) grid fence, d) nylon net fence, e) holed fence, f) fractal fence (a-e redrawn from Dong et al., 2007, f redrawn from McClure et al., 2017).

porosity; ii.) Fences with deflecting porosity.

Fences with *smeared porosity* are fences whose openings have characteristic length(s) several orders of magnitude smaller than the fence characteristic length, i.e. its height. Some schemes of the most common types of smeared porous fences are given in Fig. 20. We further subdivide smeared porosity fences as a function of the induced wake turbulence properties. In particular, porous fences will induce anisotropic turbulence when the opening characteristic length distribution is constant but differs between vertical and horizontal dimensions (Fig. 20 a, b), while they will induce isotropic turbulence when opening characteristic length distribution is the same in both dimensions (Fig. 20 c, d, e, f). The induced wake turbulence, i.e. grid-generated turbulence in the literature (e.g. Tresso and Munoz, 1999; Kurian and Fransson, 2009), has a characteristic length scale of the same order of magnitude of the solid element size. Among the latter, fractal porous fences have been recently proposed by McClure et al. (2017): they are expected to induce multiple wake turbulence characteristic length scales.

Fences with *localized porosity*, also called turbulence generators or wind weakeners in the literature, are characterized by openings having characteristic length(s) of the same order of magnitude of, or one order of magnitude smaller than, the fence height. Accordingly, the wake turbulence characteristic length scale is of the same order of magnitude of the characteristic scale of the local mean flow, and strongly interacts with it.

Some examples of localized porosity fences are given in Fig. 21: an alignment of spire-shaped glass-fiber modules (Fig. 21a and Bofah and Al-Hinai, 1986) analogous to spires usually adopted in boundary layer wind tunnels; an array of leaf-shaped concrete modules hanged by suspension cables (Fig. 21 b, Zhang et al., 2010b; Cheng and Xue, 2014).

Fences with *deflecting porosity* include solid elements inclined out of the fence plane, such as vanes, slats or plates. Some of these fences were patented in the last decades (e.g. Luebke, 1967; Rodríguez Hernández et al., 2008), but only recently scientific studies have been devoted to study their aerodynamic and sand morphodynamic behaviour (Chen et al., 2012; Cheng et al., 2016a). Fig. 22 shows the deflecting porosity fences studied in the cited papers. Both deflecting porosity fences are intended to guide the flow upwards. The working principle of the deflecting inclined elements is twofold: i. guiding the mean bleed flow along target directions, i.e. downward, upward or laterally; ii. reducing the wake turbulence intensity with respect to classic porous fences.

Fences with homogenous porosity are one of the oldest type of built SMMs (Kerr and Nigra, 1951). A traditional example is given in Fig. 23 (a). Such fences have been developed through the years in order to improve their durability and maintainability, resulting in e.g. polymer nets (Fig. 23 b). An actual example of fences with localized porosity made by reinforced concrete panels is given in Fig. 23 (c).

Porous fences with smeared porosity are often applied to promote the

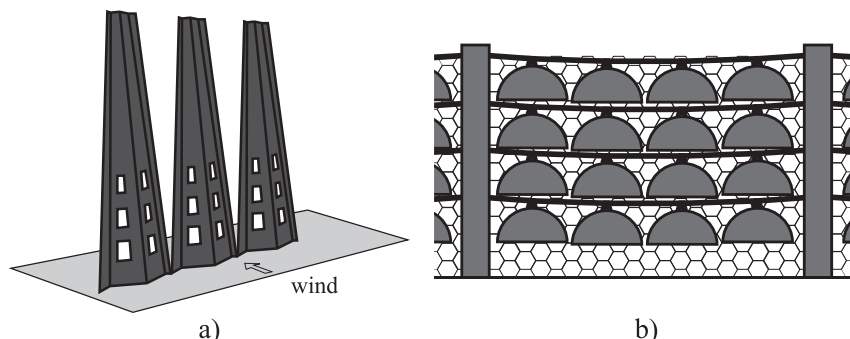

Fig. 21. Fences with localized porosity: a) spire-shaped (redrawn from: Bofah and Al-Hinai, 1986), b) leaf-shaped (redrawn from: Zhang et al., 2010b).

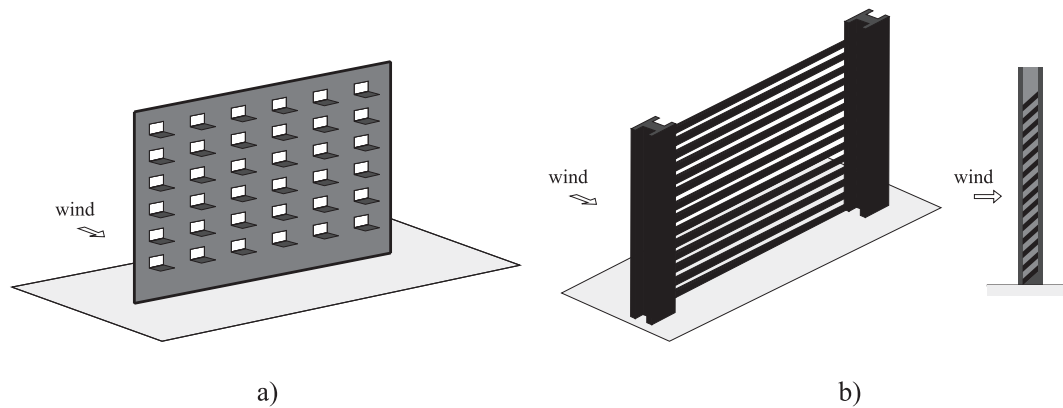

Fig. 22. Fences with deflecting porosity: a) guide plates downwind rectangular openings (redrawn from: [Chen et al., 2012](#)), b) array of inclined slats (redrawn from: [Cheng et al., 2016a](#)).

rapid growth of artificial bell-shaped dunes in coastal regions to protect residential areas from the hazardous effects of both wind and water ([Savage and Woodhouse, 1968](#)). [Fig. 24 \(a\)](#) shows a 6-year long dune growing process.

First, a single porous fence is installed where the dune is needed. When the accumulation of the sand exceeds the height of the barrier, a second barrier is positioned on top of the accumulated sand. The process is repeated each time a fence is buried. The numbers depicted in [Fig. 24 \(a\)](#) indicate the order in which porous fences were positioned. An example of questionable application of artificial dune growing for windblown sand mitigation of a village in the desert is shown in [Fig. 24 \(b\)](#), where porous fences are used to shape a dune upwind a road. The dune upwind slope acts as a launching pad for the incoming windblown sand. In the figure, it can be seen that, even though a massive dune was created upwind the road, sand is still partially covering it.

Actual porous fences are usually straight and vertical, even if inclined porous windscreens have been investigated ([Dierickx et al., 2003](#)). Conversely, the shape of *solid barriers* greatly affects the local wind pattern around them, and the sedimentation process in turn. To our best knowledge, existing solid barriers having different shapes with respect to the SVW are scarcely investigated in scientific literature so far. The parameters driving their design and controlling their performance have been systematically and rigorously discussed only recently ([Bruno et al., 2018a](#)). However, solid barriers with other shapes than SVW have been heuristically devised and patented as SMM in the past. Some examples are given in [Fig. 25](#).

[Pettus Newell \(1903\)](#) patented a λ -shaped wooden barrier for railway applications. Analogously, [Pensa et al. \(1990\)](#) patented a λ -shaped pre-cast r. c. barrier to be used as SMM for agroforestry applications. Very recently, [Bruno et al. \(2016\)](#) have patented a novel solid barriers called *Shield for Sand (S4S)*, equipped with an ad-hoc conceived upper windward concave deflector aimed at making the extent of the vortex upwind

the barrier as large as possible even for high sedimentation levels. The conceptual design of S4S has been carried out by computational simulations ([Bruno et al., 2018a](#)), and its performance assessment by wind tunnel test ([Bruno et al., 2018b](#)).

[Fig. 26](#) shows the comparison between SVW and S4S induced aerodynamics and morphodynamics for three different sedimentation levels. Both shape and size of the upwind clockwise vortex for about the same level of accumulation change significantly by varying the geometry of the solid barrier. In particular, S4S induces a larger upwind vortex with respect to SVW for low ([Fig. 26 a–b](#)) and moderate ([Fig. 26 c–d](#)) sedimentation levels and higher upwind accumulation potential and trapping efficiency in turn. The vortex upwind SVW vanishes for high sedimentation levels ([Fig. 26 f](#)), while is still present upwind S4S ([Fig. 26 e](#)). The sedimented sand upwind SVW results in a launching pad for incoming windblown sand ([Hotta and Horikawa, 1991](#)): windblown sand crosses over the SMM and contaminates the downwind strip and/or the railway, depending on the wind field in the wake, the position of the reattachment point along the downwind strip, and the width of the strip itself (i.e. variable or uncertain sedimentation area in [Fig. 26 f](#)). Conversely, properly shaped solid windward concave barriers prevent such undesired phenomena until the sedimentation level reaches the barrier height.

To our best knowledge, SVWs are the only kind of solid barriers proposed and tested up to now in actual design practice. For instance, a 4 m-high basic SVW has been proposed as a SMM in the preliminary design of the Segment 1 of the Oman National Railway Network ([Italferr, 2014](#)). A 1.5 m-high Jersey-like wall has been recently built along the Mecca-Medina high speed railway in Saudi Arabia ([Méndez, 2016](#)), showing questionable performances. Some real world SVWs applied as SMM along railways are given in [Fig. 27a–c](#). The sand sedimentation level around them is low. Conversely, high sedimentation levels around other SVW are shown in [Fig. 27d–f](#).

SVWs are made of different materials and components, built ad hoc

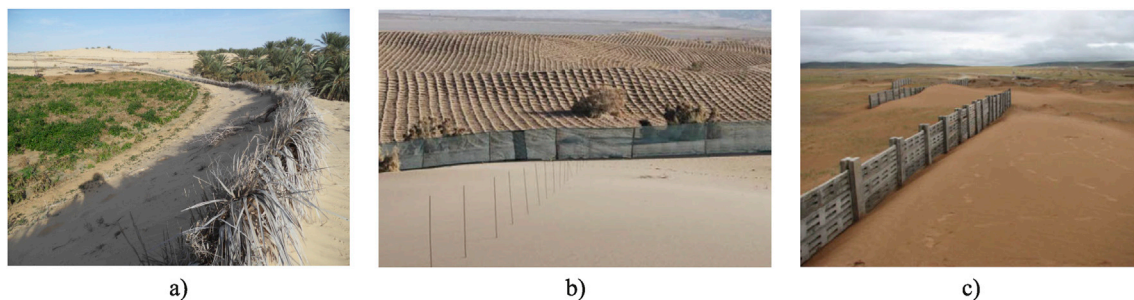

Fig. 23. Fences with smeared porosity: a) traditional fence protecting a palm plantation (explicit publishing permission from the owner of the photos: Nour Boulghobra); b) nylon net fence (reprinted from: [Liu et al., 2014](#), with the permission to reuse under a Creative Commons Attribution License). Fences with localized porosity: c) concrete fence (reprinted from: [Zhang et al., 2010b](#), with the permission from Elsevier).

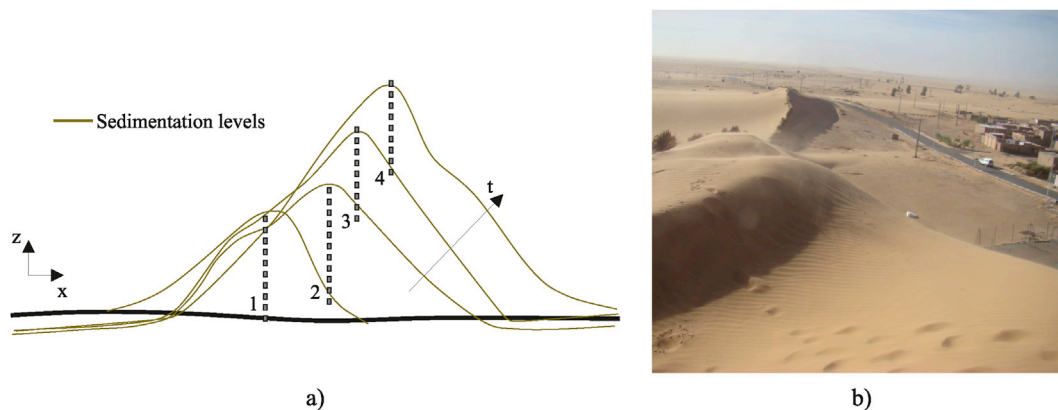

Fig. 24. Artificial dune growing: a) scheme of the process (redrawn from: [Watson, 1985](#), sand sedimentation levels scale: $Dz = 5Dx$, Fence 1 (t1) - placed in December 1962, Fence 2 (t2) - placed in January 1963, Fence 3 (t3) - placed in March 1964, Fence 4 (t4) - placed in March 1966, final shape - July 1968), b) questionable application to stop windblown sand encroaching a village (explicit publishing permission from the owner of the photo: Nour Boulghobra).

(e.g. Fig. 27 b, d, e), obtained by adapting elements from other applications (e.g. Jersey barrier in Fig. 27 a) or by recycling decommissioned ones (e.g. sleepers in Fig. 27 c and f). Some of the SVWs shown in Fig. 27 are not necessarily intended as SMM (courtyard perimeter wall, flood barrier, and sleeper stock in Fig. 27 d, e, f, respectively). However, they clearly show the attainment of upper limit of the upwind sedimentation (Fig. 27 d), the subsequent transport of sand grains up the embankment shoulder (Fig. 27 e), or the progressive burying of the downwind strip and railway track (Fig. 27 e).

4.4.2. Volume-like

Volume-like path SMMs share the same working principle of Surface-like ones: they decrease the velocity of incoming wind, induce the recirculation flow around them, and promote sand sedimentation. To our best knowledge, there are no published scientific papers specifically dealing with aerodynamics and sand morphodynamics around dykes or ditches intended as SMMs. Hence, dyke and ditch aerodynamic behaviour is regarded as equivalent to upward-backward facing step and axisymmetric cavity, respectively (schemes in Fig. 28 a, b). Corresponding qualitative schemes of sand sedimentation levels are shown in Fig. 28 (c,d).

Sand accumulation over ditches and dykes is mainly affected by their geometric parameters, i.e. height (H), width (B) and slope (α). Dykes induce flow recirculation and consequently sand sedimentation mainly on the upwind slope, while ditches reverse the flow promoting sedimentation mainly inside the cutting. At equilibrium between sedimentation and erosion, the sand accumulated along the upwind shoulder of the dike reduces its slope angle up to about 10° ([Lancaster, 1995](#)): the upwind vortex disappears, the upwind slope acts as a launching pad for incoming windblown sand, it crosses over the dyke and contaminates the downwind strip. It follows that the accumulation potential of a dike is expected to be relatively small compared to its volume. Conversely, the accumulation potential of a ditch is close to its volume, provided that its cross section is properly shaped, so that the vortex inside the cutting holds also for high sedimentation levels. From the economic point of

view, ditches and dykes involve construction costs higher than surface-like path SMMs, because of the large amount of excavation and earth-moving works. In the recent years, dikes, ditches or a combination of both have been proposed for different railway projects along the Arabian peninsula ([Phillips, 2011](#); [Plaza et al., 2012](#); [Bruno et al., 2014](#); [Conforti et al., 2016](#)).

In general, maintenance is mandatory to periodically remove sand sedimented around both surface-like and volume-like Path SMMs. Solid barriers have to be cleaned upwind before sand trapping efficiency dramatically decreases. Porous fences have to be unburied both upwind and downwind to avoid dune growing, sand contamination of the infrastructure corridor and the contamination of railway. Analogously, sand accumulated inside volume-like SMM has to be removed from dike shoulder or ditch cutting. Due to their features and location, solid barriers generally enable easier and cheaper sand removal with respect to other kind of Path SMMs. Apart from common heavy machines, some Sand Removal Machines (SRMs) have been ad-hoc conceived in the last decade in order to remove trapped sand around line-like infrastructures, such as sand cutter and blower (e.g. [Schmidt, 2013](#)).

4.5. Receiver SMM

Receiver SMMs are located directly along or over the infrastructure (e.g. along the embankment shoulder or on railway track). Such measures necessarily interact with and depend on the track superstructure (e.g. rail, sleeper or slab, ballast) and the railway functional requirements (e.g. rail gauge, safety distance from the track). Based on the working principle, receiver SMMs can be further divided into two types:

- 1 Aerodynamic-based measures aiming at reducing the sand action by controlling windblown sand transport or promoting erosion;
- 2 Sand-resistant measures, addressed to increase the sand resistance of the track system components rather than avoiding sand sedimentation.

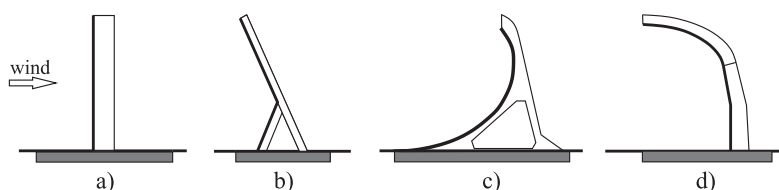

Fig. 25. Geometry of aerodynamically shaped solid barriers: a) common Straight Vertical Wall, b) pioneering shape by [Pettus Newell \(1903\)](#), c) [Pensa et al. \(1990\)](#), d) recent patent Shield for Sand ([Bruno et al., 2016](#)). Thick solid lines indicate the cross section of the aerodynamic-effective surfaces.

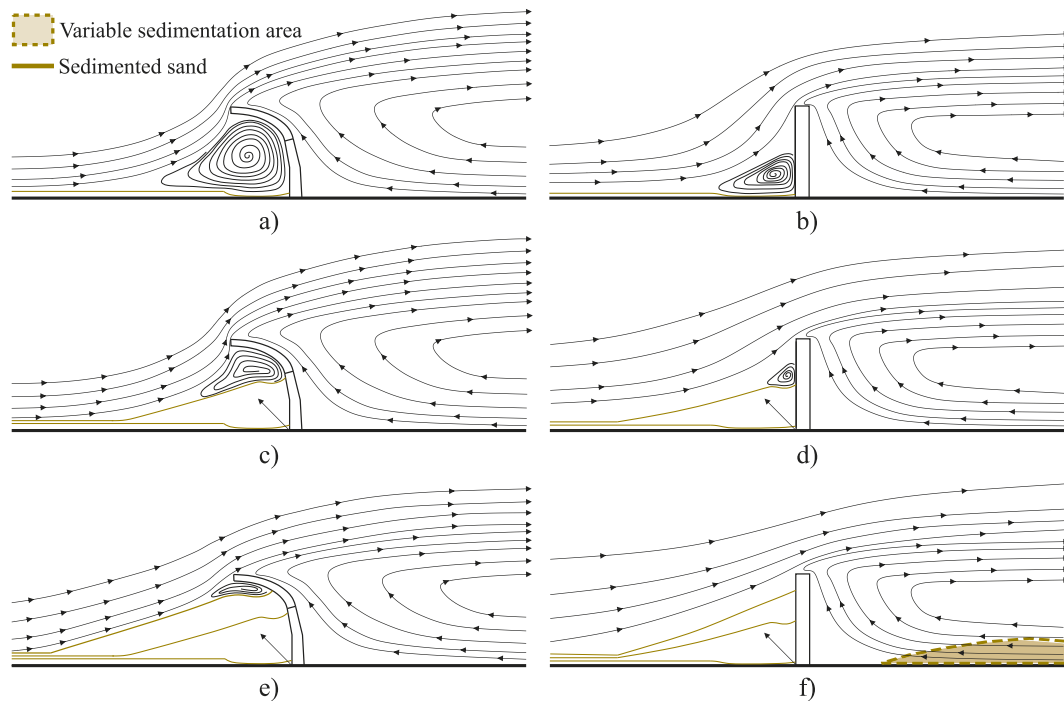

Fig. 26. Shape induced differences in wind flow mean streamlines (from computational simulations in Bruno et al., 2018a) and sand sedimentation levels (from wind tunnel tests in Hotta and Horikawa, 1991; Bruno et al., 2018b): comparison between S4S (a,c,e) and a SVW (b,d,f).

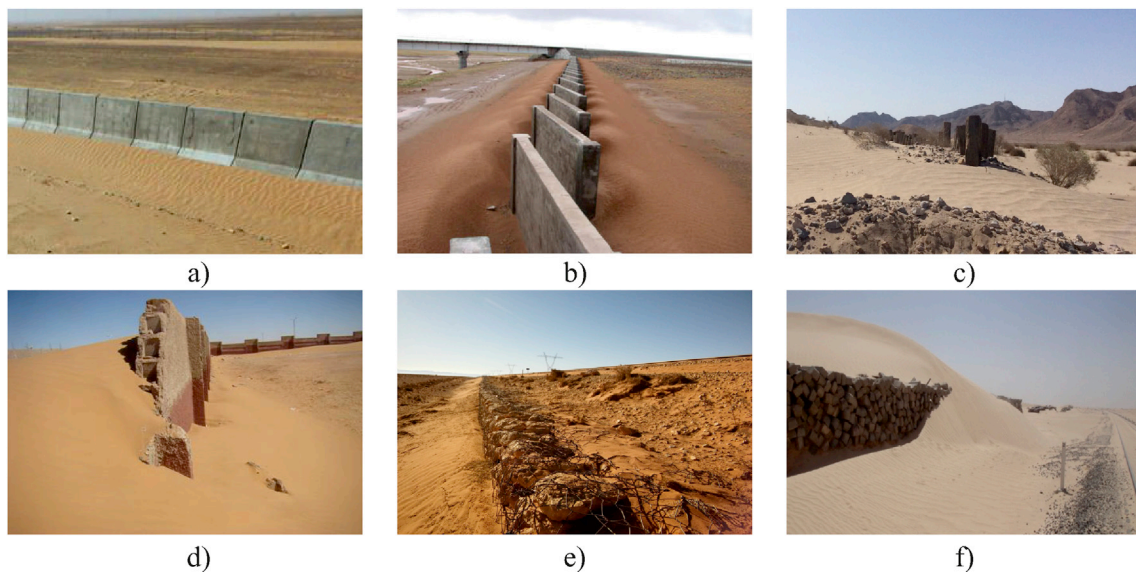

Fig. 27. Straight Vertical Walls examples: a) precast r. c. modules (owner of the photo: R. Méndez, Méndez, 2016); b) slanted, overlapped modules (reprinted from: Zhang et al., 2010b, with the permission from Elsevier); c) alignment of vertical sleepers (curtesy of Astaldi). Straight Vertical Wall sedimentation patterns: d) free standing concrete wall (explicit publishing permission from the owner of the photo: Nouar Bolghobra, Boulghobra et al., 2015); e) gabion wall adjacent to the toe of the railway embankment (curtesy of Astaldi); f) horizontally stacked sleepers (explicit publishing permission from the owner of the photo: Nouar Bolghobra).

In other words, aerodynamic-based SMMs aim at eliminating accumulated sand around the receiver, while sand-resistant SMMs are intended to increase the receiver resistance to sedimented sand.

4.5.1. Aerodynamic-based

The very first example of measure intended to control the windblown sand transport consists in the jet roof proposed by Rahim (1945) (Fig. 29 a). Such a working principle has been further proposed in patent applications by several inventors for both windblown sand (e.g. Guangyong and Peng, 2012, Fig. 29 b) and snow mitigation (e.g. Sato and Ono, 1990, Fig. 29 c).

The working principle of jet roofs relies on four common steps: i. acceleration of the multiphase flow along the upwind artificial slope; ii. lifting off of the granulated particles at the jet roof trailing edge; iii. crossing of particles over the infrastructure; iv. sedimentation of particles downwind the infrastructure. This conjectured transport mechanism seems physically sound for windblown snow, where the convective contribution of the wind flow largely prevails over the gravitational force acting on very lightweight snowflakes. Conversely, sand physics looks misunderstood: the gravity force applied on the sand grain is orders of magnitude larger than the one on snowflakes. Hence, the trajectories qualitatively sketched by Rahim (1945) presumably overestimate the

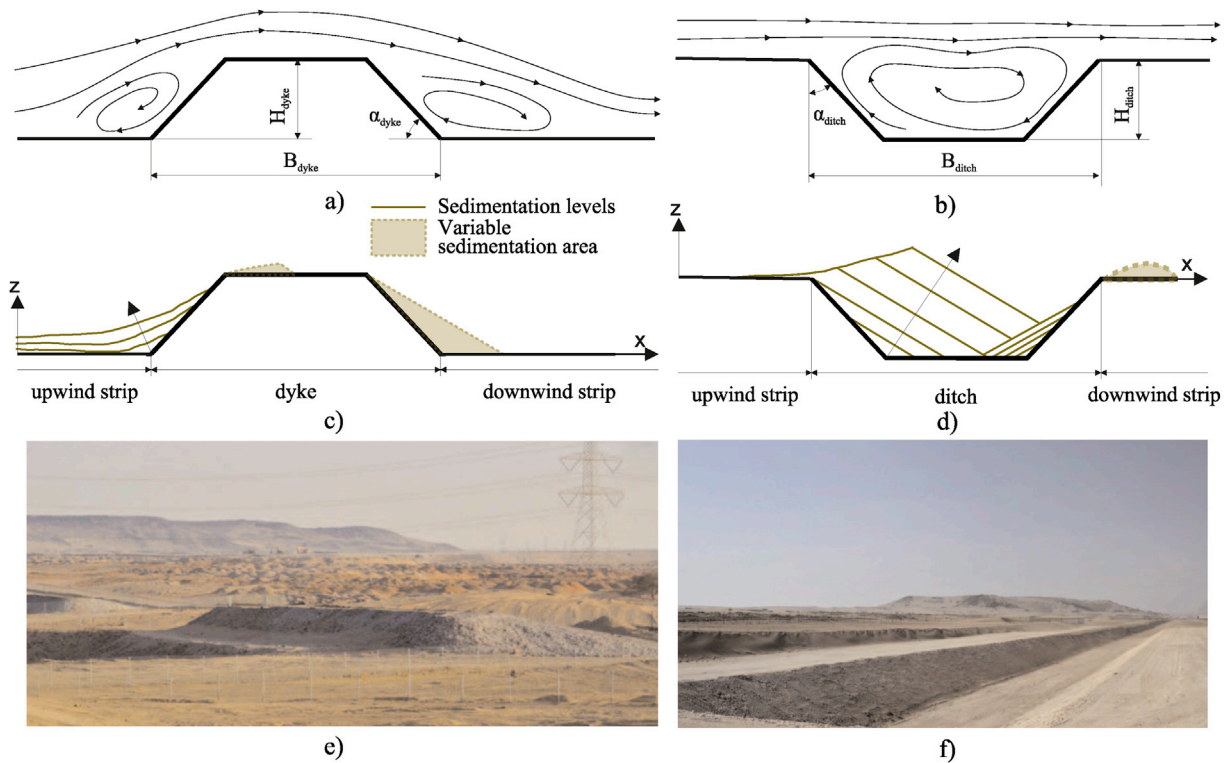

Fig. 28. Volume-like SMMs. Wind flow mean streamlines around a) a dyke (redrawn from: Pozarlik and Kok, 2012), and b) a ditch (redrawn from: Sinha et al., 2014). Sand sedimentation levels around c) a dyke (redrawn from: Hotta and Horikawa, 1991), and d) a ditch. Examples of actual volume-like SMMs during field trials: e) a dyke (reprinted from: Plaza et al., 2012), and f) a ditch (reprinted from: Plaza et al., 2012).

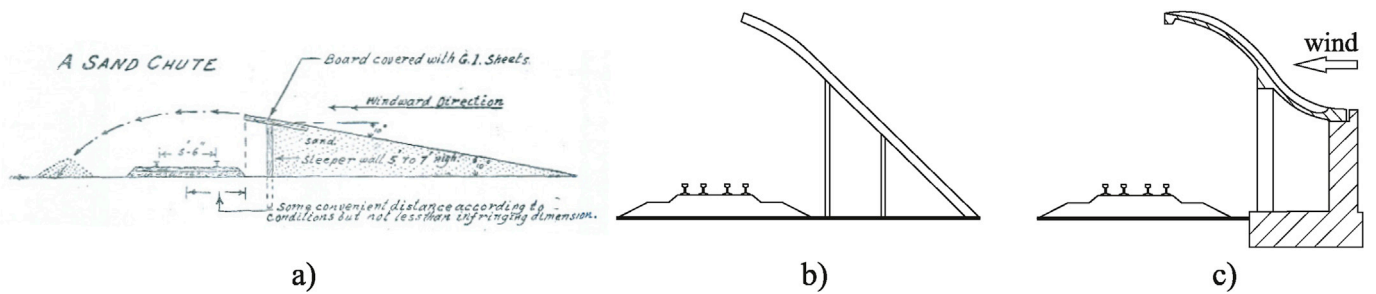

Fig. 29. Aerodynamic-based Receiver SMMs: jet roofs. a) Historical example from Rahim (1945), b) patent redrawn from Guangyong and Peng (2012), c) patent redrawn from Sato and Ono (1990).

flight length of sand grains. We conjecture the sand grains fall and sediment closer downwind the jet-roof trailing edge, i.e. on the railway track. Partially open or fully closed tunnels (e.g. Naser et al., 2013; Cheng et al., 2017), are the straightforward extension of the jet roof concept. They have evident disadvantages with respect to building costs and safety issues when extensively applied along the railway (Haack, 2002).

Among the measures intended to promote sand erosion on the railway track, let us review in particular on-track devices. They include humped sleepers within conventional ballasted track system (Riessberger and Swanepoel, 2005; Zakeri et al., 2012; Riessberger, 2015, Fig. 30 d) and humped slab track (Zakeri et al., 2011). Humped slabs have been tested in situ along the Namibian railway (Riessberger and Swanepoel, 2005) and the Iran railway (Zakeri, 2012). In all cases, protuberances elevate below the rail to support it. The working principle of humped sleepers relies on the well known Venturi effect. This type of devices rely on a growth of a local wind speed induced by the narrowing of the duct in which it flows and the directing of a wind flow towards the track components to be cleaned (Fig. 30 b, c). Fig. 30 (d) qualitatively testify the Venturi effect takes place in the opening between consecutive sleepers

and below the rail lower flange. On the one hand, this effect involves the local erosion of the sand and prevents the full obstruction of the track. On the other hand, the local deceleration of wind flow between the upwind and downwind rails involves local sand sedimentation, e.g. on signalling balises (Fig. 30 e,f). In case of a skewed prevailing wind directions ($\theta \neq 90^\circ$, see Fig. 18), we conjecture the Venturi effect weakens since the flow separates in the duct between two successive humps, and sand accumulates below the rails up to the complete clogging of the SMM. In other words, skewed wind does not see the openings of humped sleepers. Further examples of measures based on the Venturi effect are localized porosity fences with higher porosity in their lower part (Li and Sherman, 2015) and the so-called bottom-opening walls (Cheng et al., 2017). Such measures are intended to be installed in proximity of the railway track in order to promote sand erosion. According to Cheng et al. (2017), bottom-opening walls are effective for high wind speeds.

4.5.2. Sand-resistant

Some components of the track superstructure have been recently ad-hoc modified in order to make them more resistant to the sand action.

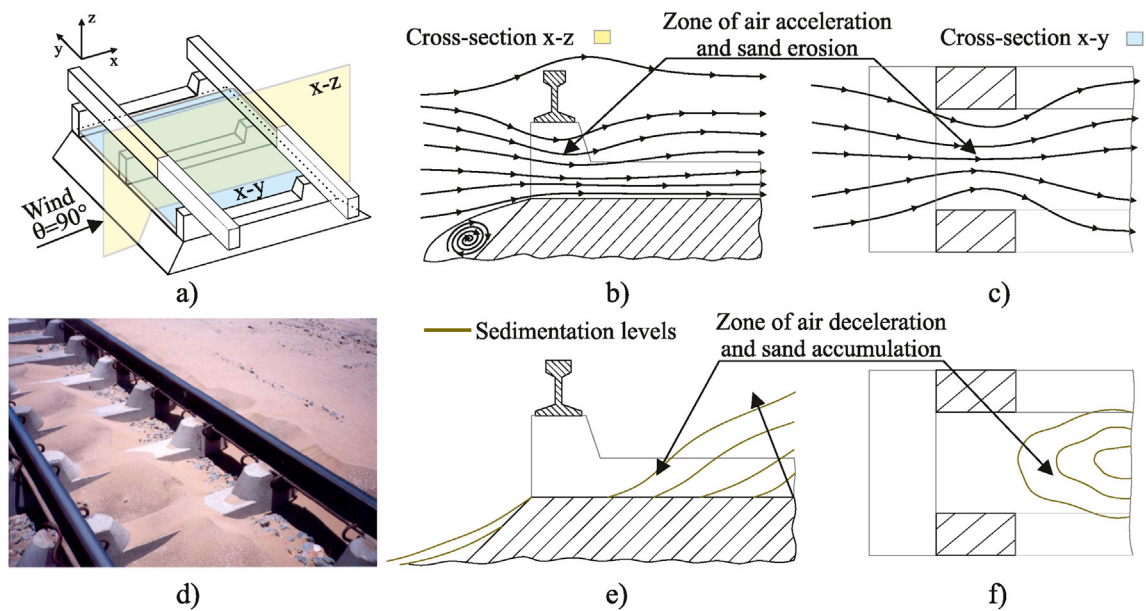

Fig. 30. Aerodynamic-based Receiver SMMs. Venturi effect-based: a) humped sleepers scheme. Streamlines in the section: x-z (b), x-y (c). d) humped sleepers (reprinted from: Riessberger, 2015, with the permission to reuse under a Creative Commons Attribution License). Qualitative sand accumulation levels in the section: x-z (e), x-y (f).

Several ballastless track systems have been tested along desert railways to avoid ballast contamination SSLs. Among them, let us recall:

- track systems with longitudinal continuous support, such as Tubular-Track (T-Track) railway system (Fig. 31 a). The T-Track system has been developed in South Africa since 1989, installed in KSA deserts in 2008 (van der Merwe, 2013) and in Namibian desert. According to van der Merwe (2013), T-Track systems have a lot of advantages compared to the ballasted railways. The main reason why they are used in desert areas is because they do not exhibit problems related to ballast fouling. On top of that, initial and maintenance costs are lower;
- track slab systems with discrete rail support (e.g. RHEDA 2000[®], currently installed in Medina-Mecca high speed line Merino, 2014, Fig. 31 b). The most significant advantages are the high stability of the track, reduced maintenance requirements (Michas, 2012), and suitability for the application in sandy deserts, making them suitable for high speed railways. However, initial costs for their construction are higher and it is more difficult to replace parts of the system in case of failure (Köllmann, 2013).

The combination of slab track system and humped sleepers results in a humped slab track. Its performance is investigated by Zakeri et al. (2011). According to them, the height of the humps should be about

80 mm in order to avoid track covering for an orthogonal incoming wind direction ($\theta = 90^\circ$), while ballast contamination is naturally avoided. No results are given for skewed incoming winds.

Ballastless systems apart, ballast protection against sand contamination could be alternatively achieved by the application of rigid-polyurethane foam as an in situ stabilization method (e.g. Keene et al., 2012; Dölçek, 2014). A recent study from Esmaili et al. (2017) addresses the improvement of ballast performance when ballast fouling takes place through the mixing of tire derived aggregate with ballast.

Further to ballast, others components of the track superstructure have been modified in order to withstand the effects of windblown sand:

- Sand-induced abrasive wear of turnout sliding components and reduced durability of lubricants have been addressed by redesigning the switch mechanism and developing lubricant-free, grease-free, or hinge-free products, e.g. the Plate Integrated Roller System (Pirolli[®]) or the Hydraulic Switching System (Hydrolink[®]) (Köllmann, 2013);
- Sand-induced rail grinding SSLs has been addressed by increasing the rail head wear and fatigue resistance. Thermal hardening of steel rails of at least R350HT grade are recommended by Pointner et al. (2009);
- Sand-induced wheel profiling SSLs are mitigated, at the present state of art, by two strategies:
 - On one side Hewitt (2015) suggested the adoption of multiple rail profiles along the tangent portions of a railway, in order to produce

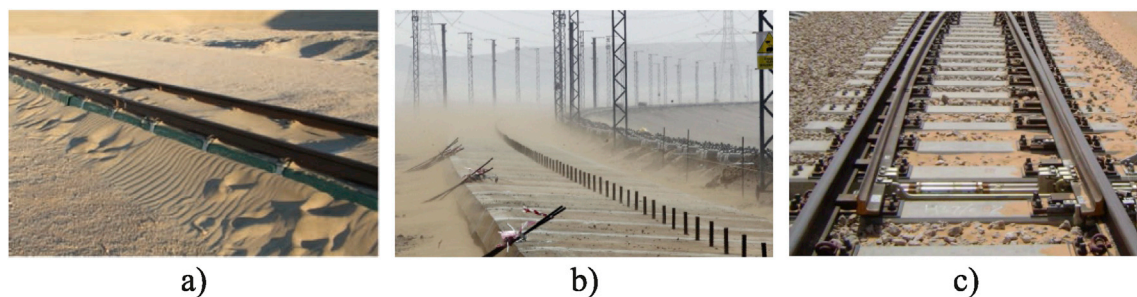

Fig. 31. Sand-resistant Receiver SMMs. Ballastless track slab systems: a) longitudinal continuous support, T-Track system (explicit publishing permission from the owner of the photo: Giles Wiggs), b) continuous slab (reprinted from: Méndez, 2016, with the permission from El Confidencial). c) Lubricant free turnout (reprinted from: Köllmann, 2013, with the permission from Voestalpine).

different contact bands on the wheels and distribute the wear across the wheel tread.

- On the other side, [Faccoli et al. \(2018\)](#) tested railway wheel made of hardened steels specifically designed for desert environments (SANDLOS H[®]) with sanding at the contact interface. Their wearing resistance was proved to be higher than the one of general purpose standard steels.

It is worth stressing that stand alone receiver SMMs are insufficient in most cases to protect the infrastructure against SULS, even if they are effective versus the target SSLS. In [Fig. 32](#) examples of inadequate performances of some receiver SMMs at SULS are given.

In [Fig. 32](#) (a) and (c) there are no path or source SMMs coupled with the receiver SMM: ballastless track is successful to prevent ballast contamination, but it is ineffective to mitigate track partial covering ([Fig. 32 a](#)) or dune encroaching ([Fig. 9 a](#)); lubricant free turnout avoids wearing of its mechanical components, but the overall switch is out of service because of the massive sedimentation between the tapering and the diverging outer rail ([Fig. 32 c](#)). In [Fig. 32 \(b\)](#) the slab track is coupled with a SVW having low trapping efficiency: ballast is not contaminated, but the track is partially covered by the windblown sand not trapped by the solid barrier. In general, receiver SMMs are useful to deal with small amount of sedimented sand, upwind efficient path SMMs are able to trap most of the incoming sand drift.

Sand removal machines (SRMs) moving on rails have been ad-hoc conceived in the last decade to clean the rail track from sand in SULS conditions. Some examples are the 46-6 SRM ([Al-Burhan Group](#), 0000) adopted in the Egypt and Iraq railway network and the SRM 500 ([Wenty, 2017](#)) used in Syrian and Kingdom of Saudi Arabia railway networks. Such SRMs have high nominal clearing capacities (up to 2300 tons/hr) required in cleaning railways at SULS, if no or low efficiency Source or Path SMMs are put in place upwind the infrastructure. Both the 46-6 SRM and SRM 500 use plough and brooms to remove sand from the tracks. The capability of SRMs to discharge the sand as far as possible from the railway/SMM is another crucial aspect. For that purpose, 46-6 SRM and SRM 500 are using slewing conveyor belt capable of discharging the sand from 3 to 5 m away from the track. In order to prevent the large quantities of removed sand to enter a new erosion-transport-sedimentation cycle, SRMs should be complemented by the complete procedure for sand disposal, by placing it in storage areas far from the railway track, and stabilization. Finally, it should be mentioned that the SRMs cited above are almost ineffective versus SSLS, particularly against ballast contamination.

5. Conclusion

Windblown sand is the main specific technical issue in design and construction of infrastructures across desert and arid regions. Windblown sand harmful effects on railways were recognized ever since the late nineteenth century, and are nowadays the environmental limiting factor that is inherent in safety and serviceability of actual railways and future projects. A growing research and technical activity has addressed this

problem in the last decade, in different fields across fundamental, environmental and engineering sciences.

This paper aims at providing a wide overview of the existing scientific and technical literature on the topic. The overview is intended to i. provide an updated multidisciplinary map of the evolving state of the art to researchers, and ii. to give a structured background to railway owners, designers, general contractors and railway operators in order to properly set up project terms of reference, and most suited design solutions. The overview is given through: i. addressing windblown sand as an environmental variable action, ii. the classification of its effects in an original framework based on windblown Sand Limit States, ii. the categorization of the Sand Mitigation Measures proposed up to now in an innovative Source-Path-Receiver scheme. In particular, the SMM categorization is given with respect to their relative position to the infrastructure, and their working principle acting on the wind flow and/or sand erosion/transport/sedimentation.

In the following, lessons learnt are briefly summarized by referring to Source-Path-Receiver classification and to their phenomenological working principles. (i) Although Source SMMs are widely adopted against desertification process at regional scales, they are beyond the field of interest, the role, and the economic capabilities of railway owners, designers, and general contractors. (ii) A number of Path SMMs are proposed in literature and some of them are extensively adopted in practice. Path SMMs appear to be likely adopted along railways since their building components are already employed in the production of other kinds of barriers (e.g. noise or wind barriers) along railway infrastructures. Whilst porous fences are widely studied in literature, solid barriers remains scarcely studied. In particular, porous fence working principle involves a significant amount of sand bleeds through the unburied fence, so that the railway corridor is necessarily contaminated. Conversely, solid barriers comply with the practical requirement of preventing sand accumulation in the railway corridor. Keeping high trapping efficiency upwind the solid barrier even at high accumulation levels is the mandatory design requirement. Such a requirement should be necessarily satisfied by the understanding of the barrier aerodynamic behaviour and its careful aerodynamic design. (iii) Receiver SMMs have to comply with railway track superstructure functional requirements. Receiver SMMs are at their infancy to date. This is because they necessarily involve a global rethinking of the superstructure components (i.e. sleepers, rail, signalling devices) and rolling stock in order to be adapted to arid environment conditions. Bearing in mind that these components results form a 150 year long optimization in European and North America countries, such rethinking cannot be envisaged in the short time design process of a single railway project. Midterm research and development programs are required for this purpose.

Albeit with a few remarkable exceptions, the rigorous quantitative assessment of SMMs performances is still missing in the scientific literature and technical practice. To the authors' opinion, this is due to the inherent multiscale and multiphysic nature of the involved phenomena, to the scaling and measurements difficulties in experimental tests, to the modelling and numerical difficulties in computational simulations. Modelling, experimental and computational efforts should be made by

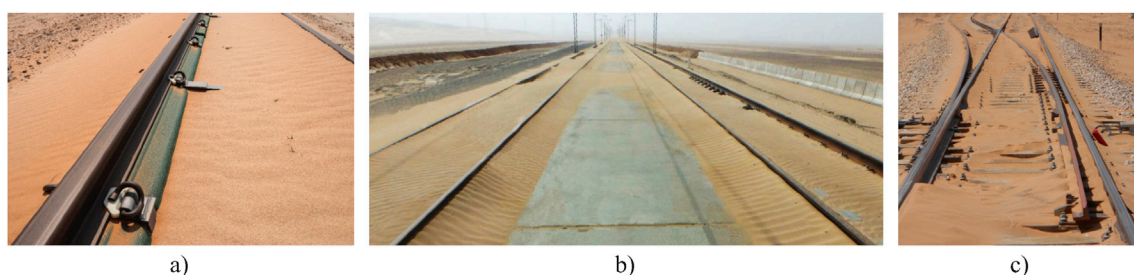

Fig. 32. Failure of Receiver SMMs: a) T-Track covered by sand (explicit publishing permission from the owner of the photo: Ciaran Nash), b) continuous humped slab covered by sand (reprinted from: [Méndez, 2016](#), with the permission from El Confidencial), c) lubricant free turnout jammed by sand (courtesy of Astaldi).

different scientific communities in the next future in order to cope with such difficulties. Once this challenging task will be accomplished, the quantitative performance assessment, the rigorous verification and the reliable maintenance cost analysis of SMMs will be possible.

Note to reader

The authors have made every effort to review and include herein all available and pertinent items in the public domain which address windblown SMMs along railway infrastructures. In spite of this, it is possible that the authors have missed some. Researchers or others knowledgeable of additional pertinent information presently unknown to the authors are encouraged to contact them. If such data would be useful in either modifying or confirming positions established herein, an addendum to this paper could be prepared.

Acknowledgments

The study has been carried out in the framework of the MSCA-ITN-2016-EID research project Sand Mitigation around Railway Tracks (SMaRT, www.smart-aid.eu). The SMaRT project has received funding from the European Union Horizon 2020 research and innovation program under grant agreement No 721798. The authors wish to thank the other researchers of the SMaRT consortium, and in particular the members of the Windblown Sand Modelling and Mitigation (WSMM) group, for the valuable contribution about the topics of the paper. The support and stimulating discussions given by SMaRT partner organizations (Ansaldo STS, Astaldi, Salcef group) is acknowledged as well.

It will be evident from the reference list that the authors are indebted to a large number of industrial and academic colleagues for much of the information that is included in this paper, and it is simply not possible to name them all. Their contribution is gratefully acknowledged. The authors would like to acknowledge the permissions given by various organizations and individuals to reproduce figures for this paper. In particular, we would like to thank Nouar Boulghobra (C.R.S.T.R.A - Algeria), Astaldi and Voestalpine for the pictures they generously shared with us.

References

- Al Rumaih, R.M., 2009. Conquering the deserts. *Railw. Gaz. Int.* 165, 46–48.
- Al-Awadhi, J., Al-Helal, A., Al-Enezi, A., 2005. Sand drift potential in the desert of Kuwait. *J. Arid Environ.* 63, 425–438. <https://doi.org/10.1016/j.jaridenv.2005.03.011>.
- Al-Burhan Group. Sand Removal Machine 46-6. <http://www.alburhangroup.com/products.php>.
- Al-Gassim, G., 2013. SAR - North South Railway Challenges. <http://fr.slideshare.net/imadhammoud/gassim-al-gassim-sar-environmental-challenges>.
- Alghamdi, A.A., Al-Kahtani, N.S., 2005. Sand control measures and sand drift fences. *J. Perform. Constr. Facil.* 19, 295–299. [https://doi.org/10.1061/\(ASCE\)0887-3828\(2005\)19:4\(295\)](https://doi.org/10.1061/(ASCE)0887-3828(2005)19:4(295)).
- Andreotti, B., Claudin, P., Douady, S., 2002. Selection of dune shapes and velocities. Part 1: dynamics of sand, wind and barchans. *Eur. Phys. J. B - Condens. Matter* 28, 321–339. <https://doi.org/10.1140/epjb/e2002-00236-4>.
- Anurag, S., 2008. Problems in maintenance of Indian railway in deserts and possible solutions. In: *UIC Workshop on Desert Railways*, pp. 67–82.
- Asi, I., Al-Abdul Wahhab, H., Al-Amoudi, O., Khan, M., Siddiqi, Z., 2002. Stabilization of dune sand using foamed asphalt. *ASTM Geotechnical Test. J.* 25, 168–176. <https://doi.org/10.1520/GTJ11360J>.
- Bagnold, R., 1941. *The Physics of Blown Sand and Desert Dunes*. Methuen. <https://doi.org/10.1007/978-94-009-5682-7>.
- Baines, W., 1963. Effects of velocity distribution on wind loads and flow patterns on buildings. In: *Wind Effects on Buildings and Structures*.
- Baker, C., 2014. A review of train aerodynamics Part 2-Applications. *Aeronautical J.* 118, 345–382. <https://doi.org/10.1017/S000192400009179>.
- Bates, C., 1911. *Windbreaks: Their Influence and Value*. Technical Report. US Dept. of Agriculture, Forest Service.
- Behbahani, A.M., 2015. Hazard and Risk Assessment of Wind Erosion and Dust Emissions in Denmark - a Simulation and Modelling Approach. Ph.D. thesis. University of Basel, Faculty of Science. <http://edoc.unibas.ch/38575/>.
- Belkacemi, B., 1984. French Railways in Algeria, 1850–1990: a Contribution to the Study of Colonial History. Ph.D. thesis. University of East Anglia.
- Bellefontaine, R., Bernoux, M., Bonnet, B., Cornet, A., Cudennec, C., D'Aquino, P., Droy, I., Jauffret, S., Leroy, M., Mainguet, M., Malagnoux, M., Requier-Desjardins, M., 2012. The African Great Green Wall project - what advice can scientists provide?. In: *CSFD Topical Issue. French Scientific Committee on Desertification, Montpellier*.
- Belly, P.Y., 1964. Sand Movement by Wind. Technical Report. US Army - Corps of engineers.
- Ben Salem, B., 1985. Mulching technique of dune fixation: the layer system. In: *Sand Dune Stabilization, Shelterbelts and Afforestation in Dry Zones*. Food and Agriculture Organization of the United Nations, Rome.
- Bernardino, A., Monti, P., Leuzzi, G., Querzoli, G., 2015. Water channel study of flow and turbulence past a two dimensional array of obstacles. *Bound. Layer. Meteorol.* 155, 73–85. <https://doi.org/10.1007/s10546-014-9987-2>.
- Bofah, K.K., Al-Hinai, K.G., 1986. Field tests of porous fences in the regime of sand-laden wind. *J. Wind Eng. Industrial Aerodynamics* 23, 309–319. [https://doi.org/10.1016/0167-6105\(86\)90051-6](https://doi.org/10.1016/0167-6105(86)90051-6).
- Boulghobra, N., 2016. Climatic data and satellite imagery for assessing the aeolian sand deposit and barchan migration, as a major risk sources in the region of in-salah (central algerian sahara). *Arabian J. Geosciences* 9. <https://doi.org/10.1007/s12517-016-2491-x>.
- Boulghobra, N., Koull, N., Benzaoui, T., 2016. Four decades period of climatic data for assessing the aeolian hazard in the region of Touggourt (Low Algerian Sahara). *Geogr. Tech.* 11, 13–22. http://www.technicalgeography.org/pdf/1_2016/03_boulghobra.pdf.
- Boulghobra, N., Saifi, M., Fattoum, L., 2015. Sand encroachment in the Saharan Algeria: the not declared disaster - Case study: In-Salah region in the Tidikelt. In: *Planet@ Risk*, 3(1), pp. 72–76. Global Risk Forum GRF Davos, Davos.
- Boulton, J.W., Carmichael, S., Lundgren, J., Phillips, D., Crosbie, E., Wiggs, G., Neuman, C., 2014. Assessing risks to infrastructure projects in the middle east from drifting and blowing sand using wrf. In: *World Weather Open Science Conference*. <https://www.wmo.int/pages/prog/arep/wwrp/new/wwoosc/documents/2014.08.07WWOSC-Boulton.pdf>.
- Bruno, L., Preziosi, L., Fransos, D., 2014. Saudi Landbridge Railway Project - Sand Mitigation Study - Sand Mitigation Measure Efficiency Final Report. Internal Report To Italferr S.P.A.
- Bruno, L., Preziosi, L., Fransos, D., 2016. A Deflecting Module for an Anti-sand Barrier, a Barrier Thus Obtained and a protection Method from Windblown Sand. *WO 2016/181417 A1*.
- Bruno, L., Fransos, D., Lo Giudice, A., 2018a. Solid barriers for windblown sand mitigation: aerodynamic behaviour and conceptual design guidelines. *J. Wind Eng. Industrial Aerodynamics* 173, 79–90. <https://doi.org/10.1016/j.jweia.2017.12.005>.
- Bruno, L., Coste, N., Fransos, D., Lo Giudice, A., Preziosi, L., Raffaele, P., 2018b. Shield for sand: an innovative barrier for windblown sand mitigation. *Recent Pat. Eng.* 12. <https://doi.org/10.2174/1872212112666180309151818>.
- Carrascal, I., Casado, J., Diego, S., Polanco, J., 2016. Dynamic behaviour of high-speed rail fastenings in the presence of desert sand. *Constr. Build. Mater.* 117, 220–228. <https://doi.org/10.1016/j.conbuildmat.2016.05.023>.
- Chen, G., Wang, W., Sun, C., Li, J., 2012. 3D numerical simulation of wind flow behind a new porous fence. *Powder Technol.* 230, 118–126. <https://doi.org/10.1016/j.powtec.2012.07.017>.
- Cheng, J.J., Xue, C.x., 2014. The sand-damage-prevention engineering system for the railway in the desert region of the qinghai-tibet plateau. *J. Wind Eng. Industrial Aerodynamics* 125, 30–37. <https://doi.org/10.1016/j.jweia.2013.11.016>.
- Cheng, J.J., Jiang, F.q., Xue, C.x., Xin, G.w., Li, K.c., Yang, Y.h., 2015. Characteristics of the disastrous wind-sand environment along railways in the Gobi area of Xinjiang, China. *Atmos. Environ.* 102, 344–354. <https://doi.org/10.1016/j.atmosenv.2014.12.018>.
- Cheng, J.J., Lei, J.q., Li, S.y., Wang, H.f., 2016a. Disturbance of the inclined inserting-type sand fence to windAsand flow fields and its sand control characteristics. *Aeolian Res.* 21, 139–150. <https://doi.org/10.1016/j.aeolia.2016.04.008>.
- Cheng, J.J., Lei, J.q., Li, y., Wang, H.f., 2016b. Effect of hanging-type sand fence on characteristics of wind-sand flow fields. *Wind Struct.* 22, 555–571. <https://doi.org/10.12989/was.2016.22.5.555>.
- Cheng, J.J., Xin, G.W., Zhi, L.y., Jiang, F.q., 2017. Unloading Characteristics of Sand-drift in Wind-shallow Areas along Railway and the Effect of Sand Removal by Force of Wind. *Scientific Reports* 7. <https://doi.org/10.1038/srep41462>.
- Conforti, V., Sacchi, F., Utzeri, L., Fulgione, D., 2016. New challenges for the design of high speed and heavy haul rail. In: *Proceedings 11th World Congress on Railway Research, Milan, Italy*.
- Cornelis, W.M., Gabriels, D., 2005. Optimal windbreak design for wind-erosion control. *J. Arid Environ.* 61, 315. <https://doi.org/10.1016/j.jaridenv.2004.10.005>.
- Davarzani, H., Smits, K., Tolene, R.M., Ilangasekare, T., 2014. Study of the effect of wind speed on evaporation from soil through integrated modeling of the atmospheric boundary layer and shallow subsurface. *Water Resour. Res.* <https://doi.org/10.1002/2013WR013952>.
- Davel Wallis, M., 2014. Freight Train Derails. *Namib Times*. <http://namibtimes.net/freight-train-derails/>.
- Dehghani-Sanij, A.R., Dehghani, S.R., Naterer, G.F., Muzychka, Y.S., 2017. Sea spray icing phenomena on marine vessels and offshore structures: review and formulation. *Ocean. Eng.* 132, 25–39. <https://doi.org/10.1016/j.oceaneng.2017.01.016>.
- Dierckx, W., Cornelis, W.M., Gabriels, D., 2003. Wind tunnel study on rough and smooth surface turbulent approach flow and on inclined windcreens. *Biosyst. Eng.* 86, 151–166. [https://doi.org/10.1016/S1537-5110\(03\)00120-X](https://doi.org/10.1016/S1537-5110(03)00120-X).
- Dierks, K., 2004. Namibia's Railway System. http://www.klausdierks.com/Namibia_Rail/
- Dölçek, T., 2014. Mechanical Behavior of Polyurethane Stabilized Fouled Ballast (PSFB). Master's thesis. Geological Engineering at the University of Wisconsin. http://minds.wisconsin.edu/bitstream/handle/1793/69518/MS_Thesis_Dolcek_Tolga.pdf.
- Dong, Z., Liu, X., Wang, H., Wang, X., 2003. Aeolian sand transport: a wind tunnel model. *Sediment. Geol.* 161, 71–83. [https://doi.org/10.1016/S0037-0738\(03\)00396-2](https://doi.org/10.1016/S0037-0738(03)00396-2).

- Dong, Z., Chen, G., He, X., Han, Z., Wang, X., 2004. Controlling blown sand along the highway crossing the Taklimakan Desert. *J. Arid Environ.* 57, 329–344. <https://doi.org/10.1016/j.jaridenv.2002.02.001>.
- Dong, Z., Luo, W., Qian, G., Wang, H., 2007. A wind tunnel simulation of the mean velocity fields behind upright porous fences. *Agric. For. Meteorology* 146, 82–93. <https://doi.org/10.1016/j.agrformet.2007.05.009>.
- Ebrahimi, A., Keene, A., 2011. Maintenance planning of railway ballast. In: *Proceedings of the AREMA Conference*, Minneapolis.
- EN 1990, 2002. Eurocode - basis of structural design - en 1990.
- EN 1991-1-2, 2002. Eurocode 1: Actions on structures - part 1-2: General actions - actions on structures exposed to fire - en 1991-1-2.
- EN 1991-1-3, 2002. Eurocode 1: Actions on structures part 1-3 general actions - snow loads - en 1991-1-3.
- EN 1991-1-4, 2005. Eurocode 1: Actions on structures - part 1-4: General actions - wind actions - en 1991-1-4.
- EN 1991-1-5, 2003. Eurocode 1: Actions on structures - part 1-5: General actions - thermal actions - en 1991-1-5.
- Esmaeili, M., Zakeri, J.A., Mosayebi, S.A., 2013. Effect of sand-fouled ballast on train-induced vibration. *Int. J. Pavement Eng.* 15, 635–644. <https://doi.org/10.1080/10298436.2013.818146>.
- Esmaeili, M., Aela, P., Hosseini, A., 2017. Experimental assessment of cyclic behavior of sand-fouled ballast mixed with tire derived aggregates. *Soil Dyn. Earthq. Eng.* 98, 1–11. <https://doi.org/10.1016/j.soildyn.2017.03.033>.
- Faccoli, M., Petrogalli, C., Lancini, M., Ghidini, A., Mazz, A., 2018. Effect of desert sand on wear and rolling contact fatigue behaviour of various railway wheel steels. *Wear* 396–397, 146–161. <https://doi.org/10.1016/j.wear.2017.05.012>.
- Feldman, F., Nissen, D., 2002. Alternative testing method for the measurement of ballast fouling: percentage void contamination. In: *Proceedings of the Conference on Railway Engineering*, Railway Technical Society of Australia, Wollongong, Australia, pp. 101–109.
- Finney, E., 1934. Snow Control on the Highways. Technical Report. Michigan Engineering Experiment Station Bulletin No. 57.
- Fryberger, S., Dean, G., 1979. A study of global sand seas. chapter Dune forms wind regime 137–155.
- Futsuhara, K., Mukaidono, M., 1989. Realization of a fail-safe train wheel sensor using electromagnetic induction. *IEEE Trans. Instrum. Meas.* 38, 421–426.
- Gazette, S., 2013. Tracks lost in sand, trains suspended. *Saudi Gaz.* <http://saudigazette.com.sa/article/48288/Tracks-lost-in-sand-trains-suspended>.
- Giannoulis, A., Stathopoulos, T., Briassoulis, D., Mistrionis, A., 2012. Wind loading on vertical panels with different permeabilities. *J. Wind Eng. Ind. Aerod.* 107–108, 1–16. <https://doi.org/10.1016/j.jweia.2012.02.014>.
- Gillies, J., Lancaster, N., 2013. Large roughness element effects on sand transport, oceanic dunes, California. *Earth Surf. Process. Landforms* 38, 785–792. <https://doi.org/10.1002/esp.3317>.
- Gillies, J., Nickling, W., King, J., 2006. Aeolian sediment transport through large patches of roughness in the atmospheric inertial sublayer. *J. Geophys. Res.* 111 <https://doi.org/10.1029/2005JF000434>.
- Gillies, J., Green, H., McCarley-Holder, G., Grimm, S., Howard, C., Barbieri, N., Ono, D., Schade, T., 2015. Using solid element roughness to control sand movement: keeler dunes, keeler, California. *Aeolian Res.* 18, 35–46. <https://doi.org/10.1016/j.aeolia.2015.05.004>.
- Gomez, L., Méndez, R., 2015. Saudis Kick up Storm over Spanish Group's High-speed Desert Rail Project. *El País*.
- Good, M., Joubert, P., 1968. The form drag of two-dimensional bluff-plates immersed in turbulent boundary layers. *J. Fluid Mech.* 31, 547–582.
- Goudie, A.S., 2009. Dust storms: recent developments. *J. Environ. Manag.* 90, 89–94. <https://doi.org/10.1016/j.jenvman.2008.07.007>.
- Guangyong, L., Peng, M., 2012. Wind-Preventing Sand-Throwing Wall. *CN/102002916 B*.
- Guo, Z., Huang, N., Dong, Z., Van Pelt, R., Zobeck, T., 2014. Wind erosion induced soil degradation in northern China: status, measures and perspective. *Sustainability* 6, 8951–8966. <https://doi.org/10.3390/su6128951>.
- Haack, A., 2002. Current safety issues in traffic tunnels. *Tunn. Undergr. Space Technol.* 17, 117–127. [https://doi.org/10.1016/S0886-7798\(02\)00013-5](https://doi.org/10.1016/S0886-7798(02)00013-5).
- Heffernan, M., 2010. *Engineering Earth - the Impacts of Megaengineering Projects*. Springer Netherlands. Chapter Shifting Sands: the Trans-saharan Railway. <https://doi.org/10.1007/978-90-481-9920-4>.
- Henry, J.C., 1952. American railroad on the arabian desert. *Pop. Mech.* 97, 107–110.
- Hereher, M., 2014. Assessment of sand drift potential along the Nile valley and delta using climatic and satellite data. *Appl. Geogr.* 55, 39–47. <https://doi.org/10.1016/j.apgeog.2014.09.004>.
- Rodríguez Hernández, J., Sañudo Fontaneda, L.A., Del Coz Díaz, J.J., Álvarez Rabanal, F.P., Garc ía Nieto, P.J.E., 2008. Protective Barrier for Snowstorms. *EP2354312A1*.
- Hewitt, T., 2015. Designing a heavy haul desert railway: lessons learned. In: 11th International Heavy Haul Conference, (IHHA 2015), Operational Excellence. Perth, Western Australia, Australia, pp. 228–237. <http://railknowledgebank.com/Presto/content/Detail.aspx?ctID=Y3RDb3B5X29mX1RoZXNlcw==&rid=MjgyNW==&ssid=c2NyZWVhSURfMTc2MzZM=>
- Hong, S.W., Lee, I.B., Seo, I.H., 2015. Modelling and predicting wind velocity patterns for windbreak fence design. *J. Wind Eng. Industrial Aerodynamics* 142, 53–64. <https://doi.org/10.1016/j.jweia.2015.03.007>.
- Hotta, S., Horikawa, K., 1991. Function of sand fence placed in front of embankment. *Coast. Eng.* 1990 (2), 2754–2767. <https://doi.org/10.1016/9780872627765.211>.
- Howard, M., 2013. The new generation of inductive sensors. *World Pumps* 2013, 10–11. [https://doi.org/10.1016/S0262-1762\(13\)70055-5](https://doi.org/10.1016/S0262-1762(13)70055-5).
- Indraratna, B., Su, L., Rujikiatkamjorn, C., 2011. A new parameter for classification and evaluation of railway ballast fouling. *Can. Geotechnical J.* 48, 322–326. <https://doi.org/10.1139/T10-066>.
- Insight, M.E.E.D., 2014. Middle East Rail and Metro Projects Report 2014. Tech. Rep. Ionescu, D., Fedele, D., Trounce, M., Petrolito, J., 2016. Deformation and degradation characteristics of sand-contaminated railway ballast. In: Pombo, J. (Ed.), *Proceedings of the Third International Conference on Railway Technology: Research, Development and Maintenance*. Civil-Comp Press, Stirlingshire, UK. <https://doi.org/10.4203/ccp.110.26>.
- ISO 9223, 1992. Corrosion of Metal and Alloys - Corrosivity of Atmospheres - Classification. <http://211.67.52.20:8088/xitong/BZ%5CISO-9223-1992.pdf>.
- Italferr, S., 2014. Preliminary Design for oman National Railway Project - Segment 1-oman/uae Border at Al Buraimi - Geotechnical Study: Sand Mitigation Report.
- Johnson, J.W. (Ed.), 1965. Federal Inter-Agency Sedimentation Conference. 970. United States Department of Agriculture Miscellaneous Publication.
- Junquera, N., 2014. Shifting Sands and 60 Million Pilgrims: the Trials of Building an Arabian Railway. *El País*.
- Kangfu, W., Jin, J., Weijing, Z., 1989. Establishment of protective system and its ecological benefit along both sides of jing-tong railway. *J. Desert Res.* 9, 1–12.
- Kaul, R.N., 1985. Sand dune fixation and afforestation: traditional procedures for dune fixation: the hedge system. In: *Sand Dune Stabilization, Shelterbelts and Afforestation in Dry Zones*. Food and Agriculture Organization of the United Nations, Rome.
- Keene, A., Edil, T., Tinjum, J., 2012. Mitigating Ballast Fouling and Enhancing Rail Freight Capacity. Tech. Rep. CFIRE 04–07, National Center for Freight and Infrastructure Research and Education. university of Winsconsin-Madison. http://www.wistrans.org/cfire/documents/FR_CFIRE0407.pdf.
- Kerr, R., Nigra, J.O., 1951. Analysis of Aeolian Sand Control. *Arabian American Oil Company*.
- Kerr, R., Nigra, J.O., 1952. Eolian sand control. *Bull. Am. Assoc. Petroleum Geol.* 36, 1541–1573.
- Kok, J.F., Parteli, E.J.R., Michaels, T.I., Karam, D.B., 2012. The physics of wind-blown sand and dust. *Rep. Prog. Phys.* 75, 106901. <https://doi.org/10.1088/0034-4885/75/10/106901>.
- Köllmann, J., 2013. Railway operations under harsh environmental conditions sand, dust & humidity problems and technical solutions/mitigation measures. In: *AHK Workshop Be a Partner of Qatar Rail*. Berlin. <http://docplayer.net/22407097-Railway-operations-under-harsh-environmental-conditions.html>.
- Kurian, T., Fransson, J.H., 2009. Grid-generated turbulence revisited. *Fluid Dyn. Res.* 41 <https://doi.org/10.1088/0169-5983/41/2/021403>.
- Lancaster, N., 1995. *Geomorphology of Desert Sand Dunes*. Routledge, Cambridge, England.
- Lee, S., Kim, H., 1999. Laboratory measurements of velocity and turbulence field behind porous fences. *J. Wind Eng. Ind. Aerod.* 80, 311–326. [https://doi.org/10.1016/S0167-6105\(98\)00193-7](https://doi.org/10.1016/S0167-6105(98)00193-7).
- Letchford, C., Holmes, J., 1994. Wind loads on free-standing walls in turbulent boundary layers. *J. Wind Eng. Ind. Aerod.* 51, 1–27.
- Li, B., Sherman, D.J., 2015. Aerodynamics and morphodynamics of sand fences: a review. *Aeolian Res.* 17, 33–48. <https://doi.org/10.1016/j.aeolia.2014.11.005>.
- Lianchan, F., 1984. Railways built in deserts and sand-prevention in China. *J. China Railw. Soc.* 3. In (Chinese).
- Lianchan, F., Jiqing, L., Yaoquan, D., 1994. Review on the prevention of sand damages to railway line in desert areas of China. *J. Desert Res.* 3. In (Chinese).
- Lihui, T., Wangyang, W., Dengshan, Z., Ruijie, L., Xuequan, W., 2015. Characteristics of erosion and deposition of straw checkerboard barriers in alpine sandy land. *Environ. Earth Sci.* 74, 573–584. <https://doi.org/10.1007/s12665-015-4059-6>.
- Lima, I., Araújo, A., Parteli, E.J.R., Herrmann, H.J., 2017. Optimal array of sand fences. *Sci. Rep.* 7 <https://doi.org/10.1038/srep45148>.
- Liu, Y., 1987. Establishment and effect of protecting system along the batou-lanzhou railway in the shapotou study area. *J. Desert Res.* 7, 1–11. In (Chinese with English Abstract).
- Liu, B., Zhang, W., Qu, J., Zhang, K., Han, Q., 2011. Controlling windblown sand problems by an artificial gravel surface: a case study over the gobi surface of the Mogao Grottoes. *Geomorphology* 134, 461–469. <https://doi.org/10.1016/j.geomorph.2011.07.028>.
- Liu, B., Qu, J., Zhang, W., Tan, L., Gao, Y., 2014. Numerical evaluation of the scale problem on the wind flow of a windbreak. *Sci. Rep.* 4, 6619. <https://doi.org/10.1038/srep06619>.
- Liu, D., Ishizuka, M., Shao, Y., 2017. Turbulent characteristics of saltation and uncertainty of saltation model parameters. *Atmos. Chem. Phys. Discuss.* <https://doi.org/10.5194/acp-2017-1090> (in review).
- Longjun, C., 2011. UN convention to combat desertification. *Encycl. Environ. Health.*
- Luebke, R.W., 1967. Fencing for Controlling Accumulation and Drifting of Snow, sand or Other Heavier-than-air Particles Suspended in Air Currents. *US3473786A*.
- Ma, R., Wang, J., Qu, J., Liu, H., 2010. Effectiveness of shelterbelt with a non-uniform density distribution. *J. Wind Eng. Industrial Aerodynamics* 98, 767–771. <https://doi.org/10.1016/j.jweia.2010.07.001>.
- Mandula, J., Salaiova, B., Koval'akova, M., 2000. Prediction of noise from tram traffic in urban units. *J. Sci. Pap. Rzeszów Univ. Technol.* 32 (180), 237–244. <https://www.infona.pl/resource/bwmeta1.element.baztech-article-BTB2-0047-0097/tab/summary>.
- Martin, R.L., Kok, J.F., 2017. Wind-invariant saltation heights imply linear scaling of aeolian saltation flux with shear stress. *Sci. Adv.* 3, e1602569. <https://doi.org/10.1126/sciadv.1602569>.
- McClure, S., Kim, J.J., Lee, S.J., Zhang, W., 2017. Shelter effects of porous multi-scale fractal fences. *J. Wind Eng. Industrial Aerodynamics* 163, 6–14. <https://doi.org/10.1016/j.jweia.2017.01.007>.

- McLaughlin, W., Brown, R., 1942. Controlling Coastal Sand Dunes in the Pacific Northwest. Technical Report. US Dept. of Agriculture.
- Méndez, R., 2016. La Arena Invade Tramos del ave Medina-la Meca. https://www.elconfidencial.com/empresas/2016-03-07/la-arena-invade-tramos-del-ave-a-la-meca-ante-la-paralisis-del-consorcio-espanol_1163269/.
- Merino, P., 2014. Arabia saudí: un reto exigente para la internacionalización de la tecnología española. *Líneas* 80, 58–67. http://www.adif.es/es_ES/comunicacion_y_prensa/doc/UltimoNumero.pdf.
- Michas, G., 2012. Slab Track Systems for High-speed Railways. Master's Thesis. Royal Institute of Technology (KTH), Stockholm, Sweden. <https://pdfs.semanticscholar.org/69f8/d0e5d9c8572bad83cfdaf1eb2f00262b20d.pdf>.
- Middleton, N., Sternberg, T., 2013. Climate hazards in drylands: a review. *Earth-Science Rev.* 126, 48–57. <https://doi.org/10.1016/j.earscirev.2013.07.008>.
- Mitchell, D.J., Fearnough, W., Fullen, M.A., Trueman, I.C., 1996. Wind Erosion and dune stabilisation in ningxia, China. <http://www.uft.uni-bremen.de/Revitalisierung/texte/1996%20mitchell%20china%20sand%20stabil.pdf>.
- Mohan, D., Yuanyuan, L., 2010. Raging Sandstorm in Inner Mongolia: Lince was Forced to Open Next Day The Railway Passenger Line in (Chinese). <http://gb.cri.cn/27824/2010/12/30/5187s3108418.htm>.
- Naser, F., Baker, C., Schmid, F., 2013. A review of railway windblown sand mitigation techniques and a structural analysis of a novel tunneling solution. In: *International Workshop on Railway Aerodynamics*. University of Birmingham.
- Nathawat, V., Sharda, A., 2005. Challenges of track maintenance in desert area - problems and remedies. *Perm. Way Bull.* 32, 1–8.
- Nicholson, J., 2005. The Hejaz Railway. *Stacey International*. <https://doi.org/10.1080/03068370600906481>.
- Oke, T.R., 1987. *Boundary Layer Climates*, vol. 435. Routledge. <https://bayanbox.ir/view/6693893538424427706/T.-R.-Oke-Boundary-Layer-Climates-Second-Edition-BookFi.org.pdf>.
- Paz, C., Suárez, E., Gil, C., Concheiro, M., 2015. Numerical study of the impact of windblown sand particles on a high-speed train. *J. Wind Eng. Industrial Aerodynamics* 145, 87–93. <https://doi.org/10.1016/j.jweia.2015.06.008>.
- Pensa, M., Spirito Petrosimo, P., Spirito Petrosimo, G., 1990. Barriera Antivento, particolarmente per venti carichi di sabbia. IT1224625.
- Pettus Newell, J., 1903. Sand Guards for Railroad Tracks. US731320.
- Phillips, D.A., 2011. Analysis of potential sand dune impacts on railway tracks and methods of mitigation. In: *GCC Transport and Railway Conference*, Doha, Qatar, pp. 17–19. <http://www.iktissadevents.com/files/events/gtrc/1/presentations/d2-s8-duncan-phillips.pdf>.
- Plaza, J.S., Barceló, M.L., de Lema Tapetado, P.R., 2012. Sand and wind: an outline of the study of aeolian action on infrastructure with reference to Haramain high speed railway, makkah–Al-madinah. *Rev. Obras Públicas* 159, 7–36. http://ropdigital.ciccp.es/detalle_articulo.php?registro=19202&anio=2012&numero_revista=3537.
- Pointner, P., Joerg, A., Jaiswal, J., 2009. Definitive Guidelines on the Use of Different Rail Grades. Deliverable Report D4.1.5GL. EU-project "Innovative Track Systems (Innotrack, TIP5-CT-2006-031415).
- Pozarlik, A.K., Kok, J.B.W., 2012. Numerical simulation of a turbulent flow over a backward facing step with heated wall: effect of pulsating velocity and oscillating wall. *Int. J. Therm. Sci.* 4 <https://doi.org/10.1115/1.4007278>.
- Preziosi, L., Fransos, D., Bruno, L., 2015. A multiphase first order model for non-equilibrium sand erosion, transport and sedimentation. *Appl. Math. Lett.* 45, 69–75. <https://doi.org/10.1016/j.aml.2015.01.011>.
- Pye, K., 1987. *Aeolian Dust and Dust Deposits*. Academic Press.
- Pye, K., Tsao, H., 2009. *Aeolian Sand and Sand Dunes*. Springer. <https://doi.org/10.1007/978-3-540-85910-9>.
- Pyrgidis, C., Dolianitis, A., Spartalis, P., 2017. The impact of specific weather conditions and natural phenomena on train operation. *Rail Eng. Int.* 4, 5–8.
- Qu, J., Zu, R., Zhang, K., Fang, H., 2007. Field observations on the protective effect of semi-buried checkerboard sand barriers. *Geomorphology* 88, 193–200. <https://doi.org/10.1016/j.geomorph.2006.11.006>.
- Raffaele, L., Bruno, L., Pellerey, F., Preziosi, L., 2016. Windblown sand saltation: a statistical approach to fluid threshold shear velocity. *Aeolian Res.* 23, 79–91. <https://doi.org/10.1016/j.aeolia.2016.10.002>.
- Raffaele, L., Bruno, L., Fransos, D., Pellerey, F., 2017. Incoming windblown sand drift to civil infrastructures: a probabilistic evaluation. *J. Wind Eng. Industrial Aerodynamics* 166, 37–47. <https://doi.org/10.1016/j.jweia.2017.04.004>.
- Raffaele, L., Bruno, L., Wiggs, G.F., 2018. Uncertainty propagation in aeolian processes: from threshold shear velocity to sand transport rate. *Geomorphology* 301, 28–38. <https://doi.org/10.1016/j.geomorph.2017.10.028>.
- Rahim, M., 1945. Behaviour of Drift Sand and Method of Dealing with it, in: *Pakistan Engineering Congress*.
- Redding, J.H., Lord, J.A., 1981. Designing for the effects of windblown sand along the new Jessah-Riyadh-Dammam expressway. In: *Symposium on Geotechnical Problems in Saudi Arabia*, pp. 363–395.
- Riessberger, K., 2015. Heavy Haul in Sand Environment. In: *IHHA 2015 Conference*. Australia, Perth. <http://railknowledgebank.com/Presto/content/GetDoc.axd?ctID=MTk4MTRjNDU0NWQ0YmY0OTBmLTIYUWUzZWJmM2U2OTE0ZDY3&rID=MjgyOQ==&pID=Nzkx&attchmnt=VHJlZQ==&uSesDM=False&rID=Mjg4OA==&rCFU=>
- Riessberger, K., Swanepoel, W., 2005. Specialised sleepers combat sand. *Railw. Gaz. Int.* 555. <https://trid.trb.org/view.aspx?id=789500>.
- Rizvi, A., 1989. Planning responses to aeolian hazards in arid regions. *J. King Saud Univ. Archit. Plan.* 1, 59–74.
- Saifi, M., Boughobra, N., Fattoum, L., 2015. The green Dam in Algeria as a Tool to Combat Desertification. *Planet@Risk*, vol. 3, pp. 1–4 (Davos: Global Risk Forum).
- Sato, A., Ono, M., 1990. Snowstorm Guard Fence Structures and Jet Roofs. US4958806A. <https://www.google.com/patents/US4958806>.
- Savage, R.P., Woodhouse, W.W., 1968. Creation and stabilization of coastal barrier dunes. In: *11th International Conference on Coastal Engineering*, London. <https://doi.org/10.1061/9780872620131.043>.
- Schmidt, A., 2013. Santera 3000 Technical Sheet. <https://www.aebi-schmidt.com/en/products/street-cleaning/sand-cutter-santera-3000>.
- Selig, E., Waters, J., 1994. *Track Geotechnology and Substructure Management*. Thomas Telford Services Ltd, London.
- Shao, Y., 2008. *Physics and Modelling of Wind Erosion*. Springer. <https://doi.org/10.1007/978-1-4020-8895-7>.
- Sherman, D.J., Li, B., 2012. Predicting aeolian sand transport rates: a reevaluation of models. *Aeolian Res.* 3, 371–378. <https://doi.org/10.1016/j.aeolia.2011.06.002>.
- Shi, L., Jiang, F.Q., Li, K.C., Xue, C.X., Kong, L., 2016. Three-dimensional simulation analysis of response law of windblown sand flow around the railway culvert. *J. Railw. Eng. Soc.* 33, 14–18.
- Shuraa, O., 2014. TerraFirma tf-2000-technical data sheet. <http://www.terrafirma.biz/>.
- Sinha, J., Das, S., Kumar, P., Prasad, J.K., 2014. Computational investigation of control effectiveness on a near transition open and closed axisymmetric cavity. *Adv. Aerosp. Sci. Appl.* 4, 45–52. https://www.researchgate.net/publication/261988204_Computational_Investigation_of_Control_Effectiveness_on_a_Near_Transition_Open_and_Closed_Axisymmetric_Cavity.
- Stigter, C., Mohammed, A., Nasr Al-amin, N.K., Onyewotu, L., Oteng'id, S.R.M.R.K., 2002. Agroforestry solutions to some african wind problems. *J. Wind Eng. Industrial Aerodynamics* 90, 1101–1114. [https://doi.org/10.1016/S0167-6105\(02\)00224-6](https://doi.org/10.1016/S0167-6105(02)00224-6).
- Stipho, A.S., 1992. Aeolian sand hazards and engineering design for desert regions. *Q. J. Eng. Geol.* 25, 83–92. <https://doi.org/10.1144/GSL.QJEG.1992.025.02.02>.
- Tennakoon, N., Indraratna, B., Rujikiatkamjorn, C., Nimbalkar, S., 2012. Assessment of ballast fouling and its implications on track drainage. In: *Narsilio, G.A., Arulrajah, A., Kodikara, J. (Eds.), 11th Australia - New Zealand Conference on Geomechanics: Ground Engineering in a Changing World, ANZ Geomechanics*, pp. 421–426.
- Terratech, 2010. *Railway Sand Drift Abatement*. <http://www.terratechinfo.com/soil-stabilization-polymer/projects/specialty-applications/railway-sand-drift-abatement>.
- Thake, T., 2012. ERTMS Implementation in Saudi Arabia. *International Strategic Rail Forum*, Abu Dhabi.
- Tresso, R., Munoz, D.R., 1999. Homogeneous, isotropic flow in grid generated turbulence. *J. Fluids Eng.* 12256, 51–56. <https://doi.org/10.1115/1.483226>.
- Tsoar, H., Blumberg, D.G., Stoler, Y., 2004. Elongation and migration of sand dunes. *Geomorphology* 57, 293–302. [https://doi.org/10.1016/S0169-555X\(03\)00161-2](https://doi.org/10.1016/S0169-555X(03)00161-2).
- Tyfour, W.R., 2008. Predicting the effect of grinding corrugated rail surface on the wear behavior of pearlitic rail steel. *Tribol. Lett.* 29, 229–234. <https://doi.org/10.1007/s11249-008-9300-y>.
- Tyfour, W.R., 2014. Effect of moving sand as a ballast contaminant on rail corrugation: field experience. *Int. J. Environ. Eng.* 6, 15–28. <https://doi.org/10.1504/IJEE.2014.057836>.
- UNISIG, 2012. FFFIS for Eurobalise, SUBSET-036 Issue 3.0.0, Mandatory Specification, ERTMS.
- van der Merwe, J., 2013. T-Track System. <http://ttracksaudi.com>.
- Wang, X.M., Zhang, C.X., Hasi, E., Dong, Z.B., 2010. Has the Three Norths Forest Shelterbelt Program solved the desertification and dust storm problems in arid and semiarid China? *J. Arid Environ.* 74, 13–22. <https://doi.org/10.1016/j.jaridenv.2009.08.001>.
- Wang, T., Jiang, C., Gao, Z., Lee, C., 2016. The influence of wind-blown sand on high-speed train aerodynamic performance. In: *Pombo, J. (Ed.), Proceedings of the Third International Conference on Railway Technology: Research, Development and Maintenance*, Civil-comp Press. <https://doi.org/10.4203/cpc.110.51>.
- Wang, T., Jiang, C., Gao, Z., Lee, C., 2017. Numerical simulation of sand load applied on high-speed train in sand environment. *J. Cent. South Univ.* 24, 442–447. <https://doi.org/10.1007/s11771-017-3446-4>.
- Wang, T., Qu, J., Ling, Y., Liu, B., Xiao, J., 2018. Shelter effect efficacy of sand fences: a comparison of systems in a wind tunnel. *Aeolian Res.* 30, 32–40. <https://doi.org/10.1016/j.aeolia.2017.11.004>.
- Watson, A., 1985. The control of windblown sand and moving dunes: a review of the methods of sand control in deserts, with observations from Saudi Arabia. *Q. J. Eng. Geol.* 18, 237–252. <https://doi.org/10.1144/GSL.QJEG.1985.018.03.05>.
- Wenty, R., 2017. The SRM 500-A high-output sand removal machine for combating sand drifts. *Rail Eng. Int.* 4, 9–10.
- Winchester, C., Allen, C., 1935a. *Railway Wonders of the World*. Amalgamated Press. chapter Through Desert and Jungle.
- Winchester, C., Allen, C., 1935b. *Railway Wonders of the World*. Amalgamated Press. chapter In Northern Africa.
- Woldman, M., van der Heide, E., Schipper, D.J., Tinga, T., Masen, M.A., 2012. Investigating the influence of sand particle properties on abrasive wear behaviour. *Wear* 294–295, 419–426. <https://doi.org/10.1016/j.wear.2015.06.008>.
- Xiao, J., Yao, Z., Qu, J., 2015. Influence of gouldm-lhasa section of qinghai-tibet railway on blown sand transport. *Chin. Geogr. Sci.* 25, 39–50. <https://doi.org/10.1007/s11769-014-0722-1>.
- Xie, S., Qu, J., Lai, Y., Pang, Y., 2015. Formation mechanism and suitable controlling pattern of sand hazards at honglianghe river section of qinghai-tibet railway. *Nat. Hazards* 76, 855–871. <https://doi.org/10.1007/s11069-014-1523-7>.
- Xie, S., Qu, J., Pang, Y., 2017. Dynamic wind differences in the formation of sand hazards at high- and low-altitude railway sections. *J. Wind Eng. Industrial Aerodynamics* 169, 39–46. <https://doi.org/10.1016/j.jweia.2017.07.003>.
- Xiong, H., Yu, W., Chen, D., Shao, X., 2011. Numerical study on the aerodynamic performance and safe running of high-speed trains in sandstorms. *J. Zhejiang*

- University-SCIENCE A Appl. Phys. Eng. 12, 971–978. <https://doi.org/10.1631/jzus.A11GT005>.
- Xu, Y., Mustafa, Y.M., 2014. Using cfd-based virtual sensor data to study the structure of air flow behind a porous fence. In: The Eighth International Conference on Sensor Technologies and Applications. https://www.researchgate.net/publication/287310511_Using_CFD-based_virtual_sensor_data_to_study_the_structure_of_air_flow_behind_a_porous_fence.
- Xu, L., Liang, X., Liu, T., Wang, Z., 2014. Experiment test of wind-sand flow destruction to train tempered glass. *J. Central South Univ. Sci. Technol.* 7, 2489–2495.
- Yang, H., Shi, C., 2018. Spatial and temporal variations of aeolian sediment input to the tributaries (the ten kongduis) of the upper yellow river. *Aeolian Res.* 30, 1–10. <https://doi.org/10.1016/j.aeolia.2017.10.002>.
- Yu Qiu, G., Lee, I.B., Shimizu, H., Gao, Y., Ding, G., 2004. Principles of sand dune fixation with straw checkerboard technology and its effects on the environment. *J. Arid Environ.* 56, 449–464. [https://doi.org/10.1016/S0140-1963\(03\)00066-1](https://doi.org/10.1016/S0140-1963(03)00066-1).
- Zakeri, J.A., 2012. Investigation on railway track maintenance in sandy-dry areas. *Structure and Infrastructure Engineering: maintenance, Management, Life-Cycle Des. Perform.* 8, 135–140. <https://doi.org/10.1080/15732470903384921>.
- Zakeri, J.A., Abbasi, R., 2012. Field investigation of variation of loading pattern of concrete sleeper due to ballast sandy contamination in sandy desert areas. *J. Mech. Sci. Technol.* 26, 3885–3892.
- Zakeri, J.A., Forghani, M., 2012. Railway route design in desert areas. *Am. J. Environ. Eng.* 2, 13–18. <https://doi.org/10.5923/j.ajee.20120202.03>.
- Zakeri, J.A., Esmaili, M., Fathali, M., 2011. Evaluation of humped slab track performance in desert railways. *Proc. Institution Mech. Eng. Part F J. Rail Rapid Transit* 225, 566–573. <https://doi.org/10.1177/0954409711403677>.
- Zakeri, J.A., Esmaili, M., Mosayebi, S., Abbasi, R., 2012. Effects of vibration in desert area caused by moving trains. *J. Mod. Transp.* 20, 16–23. <https://doi.org/10.1007/BF03325772>.
- Zhang, C., Zou, X., Cheng, H., Yang, S., Pan, X., Liu, Y., Dong, G., 2007. Engineering measures to control windblown sand in shiquanhe town, tibet. *J. Wind Eng. Industrial Aerodynamics* 95, 53–70. <https://doi.org/10.1016/j.jweia.2006.05.006>.
- Zhang, K.c., Qu, J.j., Liao, K.t., Niu, Q.h., Han, Q.j., 2010a. Damage by wind-blown sand and its control along Qinghai-Tibet Railway in China. *Aeolian Res.* 1, 143–146. <https://doi.org/10.1016/j.aeolia.2009.10.001>.
- Zhang, N., Kang, J.H., Lee, S.J., 2010b. Wind tunnel observation on the effect of a porous wind fence on shelter of saltating sand particles. *Geomorphology* 120, 224–232. <https://doi.org/10.1016/j.geomorph.2010.03.032>.
- Zhang, Z., Dong, Z., Chen, S., 2013. Wind erodibility in eastern ningxia province, China. *Environ. Earth Sci.* 68, 2263–2270. <https://doi.org/10.1007/s12665-012-1908-4>.
- Zheng, X., 2009. *Mechanics of Wind-blown Sand Movements*. Springer. <https://doi.org/10.1007/978-3-540-88254-1>.