

MoMoWo: Women Designers, Craftswomen, Architects and Engineers between 1918 and 1945

*Original*

MoMoWo: Women Designers, Craftswomen, Architects and Engineers between 1918 and 1945 / Groot, M., Seražin, H., Franchini, C., Garda, E.M.. - ELETTRONICO. - 1:(2017), pp. 1-450.

*Availability:*

This version is available at: 11583/2705273 since: 2020-01-31T11:18:53Z

*Publisher:*

France Stele Institute of Art History ZRC SAZU

*Published*

DOI:

*Terms of use:*

This article is made available under terms and conditions as specified in the corresponding bibliographic description in the repository

*Publisher copyright*

(Article begins on next page)

MOMOWO

WOMEN DESIGNERS, CRAFTSWOMEN,  
ARCHITECTS AND ENGINEERS  
BETWEEN 1918 AND 1945



WOMEN'S CREATIVITY SINCE  
THE MODERN MOVEMENT

Co-funded by the  
Creative Europe Programme  
of the European Union



Series *Women's Creativity*, 1

Editor

Helena Seražin

**International Editorial Board of the Series**

Emilia Garda and Caterina Franchini (POLITO, Turin, Italy), Maria Helena Souto (IADE-U, Lisbon, Portugal), Ana Fernandez Garcia (UNIOVI, Oviedo, Spain), Marjan Groot (VU, Amsterdam, The Netherlands), Helena Seražin (ZRC SAZU, Ljubljana, Slovenija), Alain Bonnet (UGA, Grenoble, France), Sara Levi Sacerdotti (SiTI, Turin, Italy)

ISBN 978-961-05-0033-9

**MoMoWo: Women Designers, Craftswomen, Architects and Engineers between 1918 and 1945**

Edited by

Marjan Groot, Helena Seražin, Caterina Franchini, Emilia Garda  
with assistance of Alenka Di Battista

**Reviewers:** Ellena Dellapiana, Caterina Franchini, Mario Grosso, Roberta Spallone and Marco Vitali, Polytechnic University of Turin, Italy; Maria Teresa Feraboli, Polytechnic University of Milan, Italy; Ana María Fernández García, University of Oviedo, Spain; Marjan Groot, VU University Amsterdam, The Netherlands; Paolo Nicoloso, University of Trieste, Italy; Helena Seražin, ZRC SAZU, Slovenia

**English language proof-reading**

Salmah Eva-Lina Lawrence

**Design and layout by**

Andrea Furlan, ZRC SAZU

**Issued by** France Stele Institute of Art History ZRC SAZU

Represented by Barbara Murovec

**Published by** Založba ZRC

Represented by Oto Luthar

<https://doi.org/10.3986/wocrea/1/momowo1>

<https://omp.zrc-sazu.si/zalozba-zrc/catalog/book/2>

All papers were submitted to blind peer review. The authors are responsible for obtaining copyrights for published illustrations.

Ljubljana 2017

© 2017, MoMoWo

© 2017, Založba ZRC, ZRC SAZU, Ljubljana

Cover design after a book cover by Jo Daemen for J. M. van den Houten, *Cactussen* (Rotterdam: W. J. en L. Brusse, 1927).

Publication of the project MoMoWo – Women's Creativity since the Modern Movement. This project has been co-funded 50% by the Creative Europe Programme of the European Commission. This publication reflects the views only of the authors and the Commission cannot be held responsible for any use which may be made of the information.

MoMoWo Partnership:



<http://www.momowo.eu>



ISSN 2591-0639

<https://doi.org/10.3986/wocrea>

# MOMOWO

## WOMEN DESIGNERS, CRAFTSWOMEN, ARCHITECTS AND ENGINEERS BETWEEN 1918 AND 1945

Series *Women's Creativity*, 1

# Content

8 *Preface*  
Helena Seražin

10 *Foreword to Women Designers, Craftswomen, Architects and Engineers between 1918 and 1945*  
Caterina Franchini

14 *Making Visible Women's Invisibility: The MoMoWo Project and Its Activities*  
Caterina Franchini and Emilia Garda

22 *Women as Patrons and Intermediaries: A Footnote Introducing the Articles of the First MoMoWo E-book*  
Marjan Groot

## CROSSING GEOGRAPHIES

28 *Introduction*  
Alenka Di Battista

30 *How a Young Girl Went to Wales during the Great War, to Become the Leading Lady at 'La Cambre' Institut Supérieur des Arts décoratifs in Brussels*  
Caterina Verdickt

46 *Dahl Collings (1909–1988) and Her Itinerary: Australia, England, and Back*  
Veronica Bremer

64 *'Creating Order amid Chaos': Architect Lotte Beese in the Soviet Union, 1932–1935*  
Hanneke Oosterhof

## PIONEERS AND ORGANIZATIONS

80 *Introduction*  
Alain Bonnet

82 *Women Pioneers in Civil Engineering and Architecture in Italy: Emma Strada and Ada Bursi*  
Caterina Franchini

102 *Lost in the History of Modernism: Magnificent Embroiderers*  
Sandra Heffernan

118 *Women and Their Professional Activities in Architecture: France, 1918–1945*  
Stéphanie Mesnage

132 *Women and Power in the History of Modern Architecture: The Case of the CIAM Congresses, 1928–1937*  
Rixt Hoekstra

146 *Planning Education by Post: Jaqueline Tyrwhitt's War Correspondence Course*  
Paola Zanotto

## THE HOME

156 *Introduction*  
Helena Seražin

160 *De Werkende Vrouw: In Huis en Maatschappij - Dutch Feminism, Fashion and Design 1930–1931*  
Naomi Verbeek

176 *Slovenian Women's Magazines and the Development of the Modern Home Concept in the 1930s*  
Alenka Di Battista

196 *The Role of Spanish Women in the Household and Craftwork in the First Years of the Regime of General Franco: The Women's Section*  
Ana María Fernández García

#### **VISUAL SOURCES AND WOMEN'S HISTORY**

210 *A Documentary about the Life and Work of Dutch Graphic Designer and Teacher Tine Baanders (1890–1971)*  
Marjan Groot

#### **REPRESENTATION**

212 *Introduction*  
Maria Helena Souto

214 *Modern Women in (Modern) Architecture: Some Cases (Genesis of a Modern Lifestyle)*  
Lucia Krasovec Lucas

230 *How Wide is the Gap? Evaluating Current Documentation of Women Architects in Modern Architecture History Books (2004–2014)*  
Florencia Fernandez Cardoso

250 *Anni Albers and Lilly Reich in Barcelona 1929: Weavings and Exhibition Spaces*  
Laura Martínez de Guereñu

266 *Women behind Swedish Grace – Success and Neglect*  
Maria Perers

#### **CASES FROM IRELAND TO FINLAND**

276 *Introduction*  
Ilja S. Meijer

278 *Architecture as Method of Self-Realisation: The Belfast Architect Florence Fulton Hobson*  
Tanja Poppelreuter

290 *Mary Crowley: Beginnings of the Career of a Pioneering Modern Movement Architect in Britain before 1945*  
Yasmin Shariff

304 *Women Architects in the Shadow: Aino Marsio-Aalto*  
Myriam López-Rodero

320 *The Case of Corona Krause: Textiles as a Spatial Apparatus*  
Stamatina Kousidi

336 *The Pliable Plane: Textiles, Space, and the Work of Anni Albers*  
Jennifer Burgess

#### **INTERPRETING ARCHITECTURAL DESIGNS VIA GRAPHICAL ANALYSIS AND DIGITAL MODELING**

350 *Introduction*  
Roberta Spallone and Marco Vitali

354 *Eileen Gray's Architecture of Relationships: Materiality and Spatial Layering*  
Serafina Amoroso

374 *Helena Niemirowska Syrkus: Graphic Analysis of the 'House of Dr Nelken in Warsaw'*  
Starlight Vattano

396 *Charlotte Perriand: Graphic Analysis of the 'Maison du week-end'*  
Giorgia Gaeta

406 *Redrawing as Key to the Spatial Thought of Hana Kučerová Zaveská*  
Vincenza Garofalo

422 *Lina Bo Bardi: Unbuilt in Sicily*  
Francesco Maggio

#### **DOCUMENTA**

436 *Interventions at the 1st MoMoWo Conference at the University of Leiden, the Netherlands: Four Practices, Four Women: Interviews with a Textile Designer, a Scholar of City Planning, an Industrial Designer-Engineer, and an Architect*  
Marjan Groot



Helena Seražin

## Preface

The Women's Creativity book series brings together scientific contributions on the cultural and socio-economic importance of women's' achievements in the field of architecture, interior and industrial design, landscape architecture and urban planning as well as other artistic fields such as painting, sculpture and crafts from various historical periods until the present-day. Its purpose is to present this significant part of the 'anonymous' and undisclosed European cultural heritage to the broad general and professional public.

The idea behind the Women's Creativity book series emerged within the Creative Europe project Women's Creativity since the Modern Movement –MoMoWo (Modern Movement Women)– which intends to present women's creativity particularly in the field of European architecture and design. The professional public's lack of interest for research on women artists stems largely from the insufficient awareness of their work, which is based mostly on the scarcity of preserved relevant documents and the still present stereotypes. These regard women's past 'incapability' to create on their own and on a high level to be a result of numerous social restrictions imposed on them, viewing their contribution to the development of artistic creation and to European culture as less (or un-) important. The book series is therefore, aimed particularly at encouraging scientific research and publications, which will address this incomplete image of European creativity.

The volumes will focus on selected topics. The first three will consist of scientific articles based on presentations at three international MoMoWo conferences. These consider women's creativity in the fields of architecture and design in three periods of the 20th Century (1918–1945, 1946–1968 and 1969–1989) and present a more complex image of the significant architectural and artistic movements, which shaped the culture of modernist Europe.

To ensure accessibility to the international professional and general public the Women's Creativity book series –bringing together peer-reviewed scientific articles– will be published exclusively on-line and in the English language.

Caterina Franchini

## Foreword to Women Designers, Craftswomen, Architects and Engineers between 1918 and 1945

This open-access publication is the first in an e-book series titled Women's Creativity since the Modern Movement. It is devoted to the dissemination and enhancement of gender knowledge, arising from the activities of MoMoWo project, through the scientific community and beyond.

The MoMoWo partnership is grateful to the authors of this issue, who include scholars at every stage of their careers, and who represent an inspiring diversity of interests and accomplishments that testifies to the vitality of our project.

The topic of this e-book originated from the 1st MoMoWo International Conference-Workshop, "Women Designers, Craftswomen, Architects and Engineers between 1918 and 1945" held at the University of Leiden - Centre for the Arts in Society from 23 to 25 September 2015. This topic has generated widespread interest that engaged a wide community of scholars –including academics, PhD students and professionals– in proposing studies and referring experiences to be discussed and shared in the MoMoWo framework.

One of the main MoMoWo priorities is the mobility of participants and internationalisation of studies. This has encouraged international cultural cooperation among architects, designers, art historians, architectural historians, academics and professionals belonging to public and private institutions and has supported a research process for a common challenge on the gender gap in knowledge.

From the panels presented, MoMoWo's Scientific Committee invited presenters to step up the exploration of the boundaries of history and theory of architecture, engineering and design in order to publish the scientific articles you will encounter in the following pages.

The articles have been assembled by the curators in six sub-topics, namely: "Crossing Geographies", "Pioneers and Organisations", "The Home", "Representation", "Cases from Ireland to Finland", and "Examining Drawings as Practices of Architectural Design". You will be introduced to each sub-topic through a short text written by MoMoWo's team members.

The accomplishment of this publication is the successful result of MoMoWo's challenge to scholars and researchers throughout Europe and beyond to acquire an adequate knowledge of female achievements in the fields of architecture, civil engineering and design.

This challenge is not only a matter of research results, but also a way of conveying gender equality in the perception and reception of professions that have been and are still somewhat perceived as masculine. In fact, the inclusion of a gender analysis increases the social relevance of the knowledge produced in the fields of theory and history of architecture, engineering and design and their specialist professions.

Many people have worked enthusiastically and tirelessly to create this first issue that we hope will be an inspiring publication: the trustees of the MoMoWo project and of this book series, MoMoWo's local teams, and peer-reviewers who generously served the cause. Special thanks are due to Marjan Groot who has advised and assisted the authors in the early stage of this activity and to Helena Seražin for having coordinated the double blind peer reviewing, the editing and layout process.

Caterina Franchini  
Emila Garda

## Making Women's Works Visible: The MoMoWo Project

**What is MoMoWo?** MoMoWo - Women's Creativity Since the Modern Movement is the first project to win a grant from the European Union's Education, Audiovisual and Culture Executive Agency (EACEA) to highlight women's achievements between 1918 and 2018 in the fields of architecture, civil engineering, urban planning, landscape architecture, conservation and restoration, and interior and furniture design.

MoMoWo's challenge is to make visible women's hidden achievements in design fields that have historically been considered almost exclusively a man's prerogative. Even today, some fields are still perceived as predominantly male.

Technically, MoMoWo is a large-scale cultural cooperative project co-funded by the Creative Europe Programme (2014–2020). It is a four-year non-profit project that began on October 20, 2014.

The MoMoWo partnership is transnational and multidisciplinary. Besides the International Coordinator, Politecnico di Torino (Project Leader), the partnership consists of six co-organisers, all of which are universities and research centres in Portugal, Spain, the Netherlands, France, Slovenia and Italy.<sup>1</sup>

**Why the MoMoWo Project?** The project originated from empirical evidence about gender invisibility, gained during the partners' research and teaching experiences. The contemporary history of women in design professions and the tangible cultural heritage or legacy produced by their works are still mostly unknown today, not only to the general public but also to students, scholars and professionals.

Women's works are not featured in textbooks on the history of architecture, the history of building technologies and engineering, urban history or design history. Furthermore, buildings and neighbourhoods designed by women, except for those by a few 'archistars', are rarely included in mainstream histories and or architectural guidebooks of major European cities.

**What are the main goals of the project?** MoMoWo aims to reveal and promote the contributions of women design professionals to the European tangible cultural heritage and legacy, contributions that have been significantly 'hidden from history'. At the same time, considering history as a living matter,

<sup>1</sup> MoMoWo's partners are: Creative University, Lisbon (ENSILIS/IADE); Universidad de Oviedo (UNIOVI); Universiteit Leiden (LU) –from 20 October 2014 to 30 June 2016; Znanstvenoraziskovalni Center Slovenske Akademije Znanosti in Umetnosti, Ljubljana (ZRC-SAZU); Université Grenoble Alpes (UGA); Istituto Superiore sui Sistemi Territoriali per l'Innovazione, Turin (SiTI); Vrije Universiteit Amsterdam (VU) from 1 July 2016 to present.

the project aims to promote and increase the value of the works and professional achievements of the past and present generations of women in order to give strength to future generations of creators.

The MoMoWo goal is ambitious and societal. It aims to step up support for gender equality and increase recognition for women's creativity without bias through the construction of a virtual bridge across generations, starting from the experience of the Modern Movement pioneers. In fact, the Modern Movement represents the first step in female emancipation in the architecture and design professions.

**How to increase women's visibility?** All MoMoWo activities are planned to foster knowledge, raise awareness and build consensus about women professionals.

These activities are divided into fifty work packages that are to be undertaken in close cooperation between the partners. Each activity involves downstream or upstream cultural operators, scholars, professionals, photographers, graphic designers, etc. Activities centre around research, creation, communication and dissemination.

**Mapping to know: Database with GIS.** The major research activity consists of creating a database that maps women active in Europe and European women active abroad, from 1918 up to the present time. It has been conceived and implemented to underpin the contents of the MoMoWo cultural activities and their products.

The database includes biographical data and works of both prominent and lesser-known professionals. The biographical data covers education and training, professional histories, and networks women have operated in. The networks include informal societies and memberships in trade bodies and associations. The data concerning the past was collected into three chronological spans that relate to significant periods of cultural, social and political change in Europe: 1918–45, 1946–68 and 1969–89. The database also includes the most recent period from 1989 to 2018. This last period is marked by significant historical events, namely the fall of the Berlin Wall and the end of Socialist regimes in Eastern Europe and the opportunities that globalization created for women working in the design and building fields.

Available on the MoMoWo website, the database increases the accessibility to building and sites through the application of the Geographic Information System (GIS).

**Sharing knowledge and experience: Workshops.** Three International Historical Conferences/Workshops with interviews with women's professionals were conceived as peer-to-peer learning activities, in order to share knowledge and experience.

The topics of the three workshops –held in Leiden 2015<sup>2</sup>, Ljubljana 2016<sup>3</sup>, Oviedo 2017– have reflected the three 20th century historical periods of the database. The first period, from the end of the

<sup>2</sup> <http://www.momowo.eu/1st-international-conference-workshop-booklet/>

<sup>3</sup> <http://www.momowo.eu/2nd-historical-workshop-booklet/>

First World War to the end of the Second World War, witnessed the official entry of women into the building and design fields. The second period, from the end of the Second World War to the student revolt of May 1968, was a time of expanded opportunities for female design professionals. The third period, from the student revolt of May 1968 to the fall of the Berlin Wall, was characterised by significant production, both qualitatively and quantitatively, due to the 1968 youth uprisings in Europe and the ensuing contribution of the new feminist movements.

The MoMoWo workshops have been an opportunity to stimulate critical debate, to foster new studies as well as to collect materials for the database implementation.

This e-book is the first issue of open-access publication series devoted to the studies that originated from each workshop.

**Communicating and fostering networking, active citizenship and know-how transfer: Open Days.** A key communication and networking activity is the annual open day in partners' countries held in professional women's studios to celebrate Women's Day on March 8. Via the professional orders which are patrons of the project, women professionals are invited to open their studios to visitors (students, young professionals, citizens, municipal administrators, building companies, potential commissioners) and present their works and projects, thus fostering active citizenship and creating a sense of community.

This activity has provided new professional contacts and opportunities for transferring know-how through generations. More than sixty architecture, engineering and design studios run by women opened to visitors in the 2016 and 2017 editions of this successful activity.

**Self-promotion and active involvement of creators: Agenda web page and Cultural-tourist Itineraries.** Since its inception, the MoMoWo website has an Agenda Web page where architects, engineers, designers and other users can advertise creations, publications, and activities related to MoMoWo's mission.

MoMoWo teams worked on the design of cultural-tourist itineraries of works created by women. The main result has been a guidebook.

In order to design this editorial product, an innovative and interactive approach has been applied downstream. This approach consisted of the active involvement of women architects and designers to suggest works to be included into the MoMoWo itineraries. This approach was tested during the Turin preparation of the first MoMoWo public presentation at the Festival Architettura in Città 2015. On that occasion, a call was launched, via the architects and engineers' associations, to receive works from women professionals to be presented to the public. The call asked for the creator's favourite work and not necessarily the most popular one. The works selected by MoMoWo have since become part of the Turin walking tours, "Women and the City: Fragments of an architectural talk," and of the open-air installation, "W = Women".

The MoMoWo installation was formed from the QR codes of the single works and provided the festival participants and tourists a virtual journey across buildings and interiors designed by women in Turin.

The professionals who participated in these events have become MoMoWo's first ambassadors and we offered to publish their works in the MoMoWo guidebook published in 2016, *Women: Architecture & Design Itineraries across Europe*.

**Disseminating through cultural tourism: Guidebook.** The MoMoWo guidebook resulted from MoMoWo's cultural tourist itineraries. It is the first architectural guide devoted specifically to women's works in Europe. It is a 236-page book presenting 18 itineraries and 125 works. The itineraries focus on four cities (Barcelona, Lisbon, Paris and Turin) and two countries (the Netherlands and Slovenia) that are representative of the MoMoWo partnership and evocative of cultural, geographic and landscape varieties across Europe. A biographical article about one or more women pioneers completes the geographical sections.

The MoMoWo guidebook is a pilot product since its format can be extended to other cities and countries, as well as to others fields of interest.

The purpose of this publication is to encourage visitors to have a personal dialogue with European cities and countries along the most varied and even unusual itineraries showcasing different types of urban and non-urban works, sites, and buildings.

To include a large number of women professionals, we decided to restrict the number of works from the same creator, thus favouring the visibility of many different creators and lesser known architects and interior designers worthy of attention for the quality of their work. The selection of works was undertaken to offer a wide variety of building types and to include *ex novo* buildings or reuse of existing buildings, refurbishments and restoration works, extensions of buildings, urban designs, garden designs, landscape architecture as well as interior designs.

The MoMoWo guidebook has been printed in 3000 copies –freely distributed– and the digital version is available open-access.<sup>4</sup>

**Raising awareness and building consensus: International Competitions.** To raise awareness and build consensus about MoMoWo's mission, two international competitions were organised during the first-year project. The challenge was to transform potential audiences and non-audiences from passive receivers into active creators.

The first competition for the design of the MoMoWo visual identity, logo and a promotional object was launched at the inception of the project. This competition was open to graphic designers under the age of 35, while women prisoners in the Lisbon penitentiary manufactured the promotional objects.

<sup>4</sup> <http://www.momowo.eu/cultural-touristic-itineraries-guide-book/>

All submitted logos have been exhibited under the title "MoMoWo thread" at the Festival Architettura in Città 2015, in Turin. The logos were printed on objects of daily use such as pillowcases, dish towels, aprons, tablecloths, and placemats silent witnesses to time divided between a building site, a design project, a washing machine and an iron. The idea for the exhibition set-up originated from a quite playful observation about the role of women that is still perhaps not entirely free from the 'sweet tyranny' of housework.

The second competition, **Photography reportage on a woman designer's own home**, was devoted to self-perception and representation. It focused on existing mediation between domestic activities and professional work. These reportages portray women professionals inside the home designed, not for a commissioner, but for themselves and their families.

In 2017, the selected reportages have been exhibited in Turin at the Festival Architettura in Città and in Seoul at the 26th World Architects Congress of the UIA - Union Internationale des Architectes.

These photographic projects are also part of the MoMoWo International Travelling Exhibition and its catalogue, which are the main means of project dissemination.

**Showing women's achievements: International Travelling Exhibition and its Catalogue.** The MoMoWo exhibition opened in Oviedo in July 2016 then moved to Lisbon, Grenoble, Delft, Eindhoven, and Ljubljana. After its Turin stop in 2018, the exhibition is expected to move to other cities in Europe and beyond.

The exhibition is organised into two sections, indoor and outdoor, and addresses not only specialists but also the general public and non-audiences. The outdoor section, showing the results of the photo competition, is designed to be viewed in urban public spaces, such as streets, courtyards, squares, and train stations. The indoor section consists mainly of an interactive digital exhibition entitled "MoMoWo. 100 Works | 100 Years | 100 Women" that shows the first results from the MoMoWo database.

The Catalogue describes how women in Europe have reacted with inventiveness to the architectural and design profession's restrictive and sometimes discriminatory practices, engendering innovations in their professional fields.

The number of published works is symbolic, as 'one hundred' could also mean 'countless' as in the Latin word *centum*. The number of women designers –each work has a different designer– derives from MoMoWo's choice to represent many different creators, consequently also popularising lesser-known figures.

This catalogue is a 360-page book with more than 550 images, 100 entries, 13 thematic essays, and covers 28 countries in Europe and beyond. More than 300 women architects and designers are listed in the index of names. The 45 authors of texts are not just members of MoMoWo's teams but also European experts invited to contribute to the project.

The first section of the catalogue presents the 100 works exhibited and the biography of their 100 authors.

Alongside the 100 selected works goes “ChronoMoMoWo”, the timeline of women’s achievements in winning greater civil rights, higher education, and public recognition of their work or career.

Hopefully, this book will suggest new historical visions that include the greatest works by women architects and designers in the mainstream history of architecture and design, thus enriching the discipline.

Like all other collections, the meaning of MoMoWo’s collection cannot be completely defined by the intrinsic values of its collected works. It derives meaning by its ability to provoke a conscious process of attributing meaning by its public. To support this dialectical process and to avoid the risk of treating History as a series of *sequentia fxa* or even closed ‘totalities’, a series of essays provides the reader with arguments that cross and break the linear sequence, sometimes bypassing the geographical confines of Europe and offering examples and comparisons from elsewhere in the world.

The Catalogue maps a fascinating and evocative history of tangible European cultural heritage created by women. Being a ‘sampling’, the MoMoWo collection is a slice of history, telling us something that transcends specific values of the presented works, becoming not only a bridge between creator and user but also between the authors and future creators.

The Catalogue was published in a run of 3000 copies and freely distributed. An open-access digital version is available at [www.momowo.eu](http://www.momowo.eu).<sup>5</sup>

**Seeking new research pats.** The MoMoWo 2018 International Symposium at the Politecnico di Torino seeks new research paths and activities that highlight and disseminate knowledge that eliminates gender bias against women in the present and in future societies.

<sup>5</sup> <http://www.momowo.eu/travellingexhibitioncatalogue/>

Marjan Groot

## Women as Patrons and Intermediaries: A Footnote Introducing the Articles of the First MoMoWo E-book

The first MoMoWo conference-workshop, held from 23 to 25 September 2015 at the University of Leiden in the Netherlands, focused on women designers, craftswomen, and architects and engineers between 1918 and 1945 in relation to the breakthrough of modernism. This was, however, a less homogeneous modernist period than it might seem. Between 1918 and 1925, principled functionalist modernism was not yet established, and in those years avant-garde developments culminated in the Dutch movement called De Stijl. Besides this, the majority of women worked in a modernist idiom that was derived from Art Deco or local traditional or vernacular design. Their work was of considerable interest, and examples were included in the MoMoWo project's publication *MoMoWo 100 works in 100 years. European women in architecture and design 1918–2018* (Ljubljana/Turin: France Stele Institute of Art History ZRC SAZU, 2016).

International modernism with its focus on functionalism became visible only after 1925. The Congrès Internationaux d'Architecture Moderne (CIAM), founded in June 1928 in Switzerland and active until 1959, stimulated the international dissemination of this particular form of modernist architecture. The congress was organised by Le Corbusier in collaboration with Héléne de Mandrot (1867–1948, Fig. 1). Héléne de Mandrot was a patron of Le Corbusier and owned the Swiss Château de la Sarraz where the first meeting was held. Architectural critic and historian Sigfried Giedion –who, with his wife, the art historian Carola Giedion-Welcker turned his own house in Zurich into a meeting place for artists– was the secretary-general. Héléne had attended the famous private art school, Académie Julian in Paris and had been active as a decorative designer and artist in Paris as well. From 1922, she organised various meetings with a focus on modern art and culture at her Château, in which she had created a Maison des Artistes; in 1929, a year after CIAM, there was a meeting on international independent cinema.<sup>1</sup>



Fig. 1. Héléne de Mandrot, Le Corbusier, and Paul Otlet in Geneva, autumn 1929. Web, accessed 20 September 2017.

<sup>1</sup> A. Baudin, *Héléne de Mandrot et la Maison des Artistes de La Sarraz* (Lausanne: Payot, 1998).

In modernist architecture and CIAM, Hélène's role was equally significant. In his book *Space, Time, and Architecture. The Growth of a New Tradition*, Giedion recalled:

In February 1928, I received a letter from Madame Hélène de Mandrot, telling me she was about to visit Zurich. The purpose of this visit was to arrange for a meeting of architects connected with this new movement at her château of La Sarraz, a few kilometers north of the lake of Geneva in the canton of Vaud. Madame de Mandrot had already spoken of this possibility with Le Corbusier and other friends (P. Chareau, G. Guevrekian, and others) in Paris. The term "congress" was to be employed in its original sense of "working together." ... Three circumstances favored an international union of young architects. One was the initiative of Hélène de Mandrot, who had founded the *Maison des Artistes* and had already held a meeting of young painters. She now invited young architects from Belgium, Germany, France, Holland, Italy, Austria, Spain, and Switzerland to meet at this neutral spot in the center of Europe.<sup>2</sup>

Interestingly, Giedion's canon-forming overview *Space, Time, and Architecture*, narrating the historical development of architecture towards modernism, was translated in 1954 to Dutch by a female patron of the Dutch avant-garde of De Stijl, Mathilda Brugman (1888–1958, Fig. 2).<sup>3</sup>

In 1922 or 1923, Til Brugman had commissioned Hungarian-born artist Vilmos Huszár to devise a new colour scheme for the living cum music room of her old city-house in The Hague where she lived with her friend, the singer, Sienna Masthoff. Huszár's *Spatial-Colour-Composition in Gray* of white, black and gray planes of rectangles and squares was furnished with a lamp by himself and a white-painted chair and a red-blue-yellow side table by the designer Gerrit Rietveld (Figs. 3 and 4).<sup>4</sup>

This white-painted chair is as remarkable as though much less famous than Rietveld's *Red-Blue* version of the chair, which today can be admired in museums all over the world. Til Brugman was not



Fig. 2. Til Brugman. Web, accessed 30 September 2017.

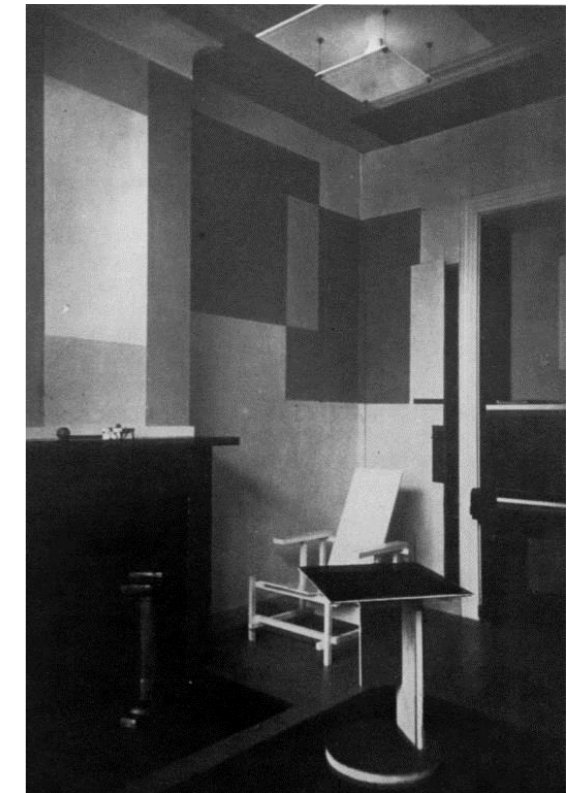
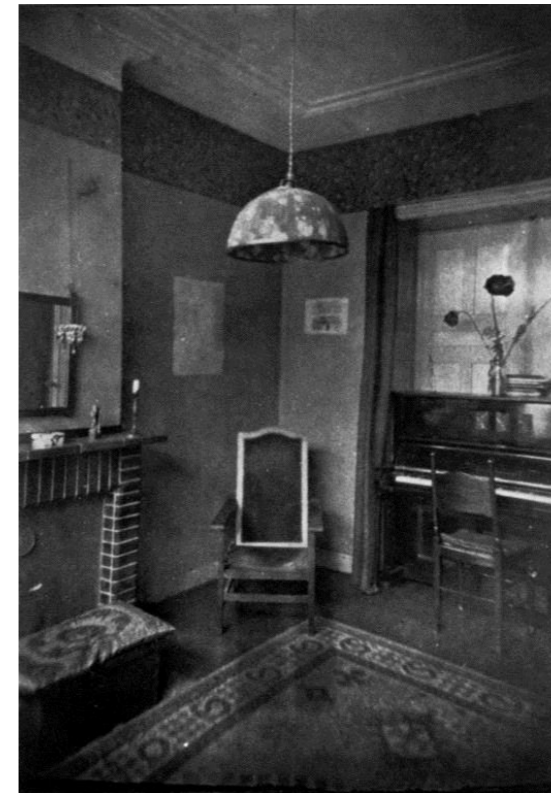

Figs. 3 and 4. Til Brugman's refurbished living cum music room; left, original appearance; right, refurbishment with wall composition and lamp designed by Vilmos Huszár and chair and side table by Gerrit Rietveld, Ligusterstraat 20, The Hague, 1923. Photographs Collection Stedelijk Museum Amsterdam.

a visual artist or designer, but a poet of dada-inspired 'sound poems' and an essayist. She earned an income by teaching languages and translated texts from various languages. A friend and supporter of many architects and artists who formed the international avant-garde networks, she corresponded with figures such as Russian artist El Lissitzky and German artist Kurt Schwitters.<sup>5</sup> Their letters give a lively impression of the contacts between Til and the artists. In July 1923, for example, Lissitzky wrote –addressing her as Tisi– that Rietveld had made a chair for him:

Liebe Tisi, von den Tag wie ich bin weck aus Holland, wollte ich jeden Tag Ihnen Lange Briefe schreiben ... Heute ist angekommen ein Brief von Rietfeld. Schreibt das er hat für mich ein Stuhl gemacht ....<sup>6</sup>

<sup>2</sup> *Space, Time, and Architecture. The Growth of a New Tradition* was first published in 1941; this quote is from the fifth revised and enlarged edition (Cambridge MA: Harvard University Press, 1969), 696. French architect and furniture designer Pierre Chareau, together with Dutch architect Bernard Bijvoet, designed the early modernist glass and metal *Maison de Verre* in Paris in 1928–32. Armenian architect Gabriel Guevrekian was most known for the design of a Cubist garden at Villa Noailles in Hyères in southeast France.

<sup>3</sup> The Dutch version is Siegfried Gideon, *Tijd, Ruimte, Bouwkunst. Vertaald door Til Brugman en inleiding door C. Van Eesteren* (Amsterdam: Wereldbibliotheek, 1954). This does not include the later texts by Gideon about CIAM.

<sup>4</sup> In Dutch, the room was called a 'Ruimte-Kleur-Compositie in Grijs'. See also Nancy J. Troy, *The De Stijl Environment* (Cambridge Mass/London: MIT, 1983), 46–49; Marijke Kuper, Lex Reitsma, *De stoel van Rietveld/ Rietveld's Chair* (Rotterdam: nai010 uitgevers/publishers, 2012), 99 and plate 19.

<sup>5</sup> The 25 letters, written between 1923 and 1926, were discussed in 1997 by Carel Blotkamp, "Liebe Tilit, brieven van El Lissitzky en Kurt Schwitters aan Til Brugman, 1923-1926", *Jong Holland* 13 (1997) 1, 32–46, and *Jong Holland* 13 (1997) 4, 27–47, 62. The letters are preserved in Netherlands Institute for Art History (RKD) in The Hague.

<sup>6</sup> 'Dear Tisi, from the day I left Holland, I want to write you long letters every day... Today has arrived a letter from Rietfeld. Writes that he has for me made a chair ...'. *Blotkamp* 13 (1997) 1, 39. [Translation MG; El Lissitzky's writing is a mixture of German and Dutch words.]

From 1926 Til lived in the house together with German dada artist, Hannah Höch from Berlin. The room remained as avant-garde as it was: a photograph from 1929 shows another chair by Rietveld, a painting by Höch and, on Rietveld's side table, an abstract sculpture by Schwitters called *Vertikal*.<sup>7</sup> In the same year Hannah Höch had a solo exhibition at the De Bron gallery for design and decorative art in The Hague. This gallery was managed by Ditte van der Vies-Heyting, the lover of the designer Chris Lebeau, who was the founder of the gallery and, from 1904, active as one of the most outstanding designers and craftsmen of the Netherlands.<sup>8</sup>

Both Til Brugman and Hélène de Mandrot, as well as Ditte van der Vies-Heyting, deserve attention in this footnote introduction because the first MoMoWo conference-workshop devoted relatively little attention to women as patrons, gallery leaders, or journalists. Rather, it favoured women as architects and designers who actively designed the international modernist canon, including some less modernist case studies compensating for this one-sided perspective as well. Many of those women architects and designers from different countries feature in this sumptuous e-book by authors from as many different countries. However, as other scholars have also argued, the role of women as intermediaries—be they collectors, patrons, or journalists—is of vital importance for a more inclusive history of architecture, design, art, and culture in general.

7 Reproduced in Blotkamp 13 (1997) 4, 31 fig. 7.

8 De Bron means The Source. Report of the opening of Gallery for Art and Decorative Art De Bron in 'Kunstkroniek', *De Residentiebode*, 20 June 1925. For Lebeau: Mechteld de Bois e.a., *Chris Lebeau 1878–1945* (Assen/Drents Museum, Haarlem/Frans Halsmuseum, 1987), 122, 189, 192–193, 253. For Til Brugman: Marleen Slob, *'De mensen willen niet rijpen, vandaar': Leven en werk van Til Burgman* (Amsterdam: VITA, 1994). For Höch's stay in the Netherlands: Chris Rehorst, 'Hannah Höch und die Niederlande', in: *Hannah Höch 1889–1978: Ihr Werk, Ihr Leben, Ihre Freunde* (Berlin: Berlinische Galerie and Argon, 1989), 41–52; and Maud Lavin, *Cut with the kitchen knife. The Weimar photomontages of Hannah Höch* (New Haven/London: Yale University Press, 1993), 65–67.

Alenka Di Battista

## Crossing Geographies

### Introduction

Migrants and migrations played an integral role in the global diffusion of Modernism between World War I and World War II. They were crucial for the emergence of diverse contemporary modernist tendencies in architecture, urban planning and design alike, in the transfer of knowledge and ideas, as well as in the creation of international professional networks. This was also the case of pioneer women architects whose lives and practices are discussed in this sub-topic “Crossing Geographies”.

Caterina Verdickt, in “How a Young Girl Went to Wales during the Great War, to Become the Leading Lady at ‘La Cambre’ Institut Supérieur des Arts décoratifs in Brussels”, presents the case of Marie and Elisabeth De Saedeleer, the elder daughters of Belgian artist Valerius De Saedeleer, who became accomplished and successful at weaving, binding and tapestry while they were living and working in Wales. She examines the causes of emigration of Belgian artists’ to Wales shortly after the outbreak of WWI and sheds insights into Elisabeth’s professional activity after her return to Belgium.

Veronica Bremer, in “Dahl Collings (1909–1988) and Her Itinerary: Australia, England, and Back”, traces Australian artist and designer Dahl Collings’, overseas experiences in London. Bremer focuses on Collings’ collaboration with Laszlo Moholy-Nagy on the interior design and presentation of the Simpson’s Department Store in Piccadilly, as well as on her contribution to the development of Australian Modernism.

In “‘Creating order amid chaos’: Architect Lotte Beese in the Soviet Union, 1932–35”, Hanneke Oosterhof reconstructs the working experience of German urban planner and architect Lotte Stam-Beese’s in the Soviet Union between 1932 and 1935. Oosterhof takes into account Stam-Beese’s recollections of the period and compares it with architectural historians’ understanding of the work of western architects, who were active in the Soviet Union.

This selection of case studies demonstrates how living abroad provided women architects with new professional opportunities for developing their skills and expanding horizons. Their contacts with internationally famous architects played an important role in their training and also influenced the diffusion of modernist ideas about architecture, urban planning and design in their home countries.

## How a Young Girl Went to Wales during the Great War, to Become the Leading Lady at 'La Cambre' Institut supérieur des arts décoratifs in Brussels<sup>1</sup>

This article will elaborate on the case of Elisabeth De Saedeleer who by invitation of the Davies sisters of Aberystwyth made Wales her home during the Great War. Elisabeth worked in Aberystwyth until 1922, commissioned to do so by the Davies sisters, who were keen on injecting Aberystwyth's cultural life with the expertise of refugee-artists. Elisabeth trained in tapestry weaving in the William Morris tradition, and when back in Belgium her tapestry firm would grow out to be an important one in the Interwar period.

The exile in Wales clearly influenced the De Saedeleer's oeuvre and her further development and allows one to study the interaction of the artist with the political-cultural life in Wales, and also how the Welsh art-life in its turn gave impulses. On her return to Belgium Elisabeth would become out to be a sought-after artist, who cooperated with modernist designers and architects for over more than a decade. She was invited to teach at La Cambre by founding director Henry Vande Velde in 1925. Both Welsh and Belgian archives, sources and designs are now being researched and analyzed in order to portray this aspects of Belgian interior design which has never before been researched.

Keywords: war refugee, interior design, tapestry, Belgium, Arts and Crafts

At the beginning of the Great War in August 1914 Belgium was a neutral country. The German invasion came as a shock and the German atrocities were so extreme, that vast masses of the Belgian population left their homes and fled to France, the Netherlands and Great Britain. Hundreds of thousands of Belgians passed the ports of Antwerp and Ostend and tried to board a boat to cross the channel (Fig. 1). In total over 150 000 Belgians, of whom approximately 300 were artists of all sorts, would stay for a shorter or a longer period in Britain during the War.

The many refugees caused chaos, especially in the first months of the war, due to the surprise attack of the Germans, but, however chaotic it might have been, the British press spoke of a peaceful invasion. The Belgians were in general not seen as a threat. At that time it was clear that their stay would be temporary.<sup>2</sup>

Once the refugees arrived in Folkestone, for instance, they were transported to London by train (Fig. 2). There they were registered at the offices of the War Refugee Committee in the General Building of Aldwych in London. This committee sought to house, clothe and provide for the Belgians. After a few months many Belgians found their own place to stay, and started to organize their temporary lives in the United Kingdom (UK). The War Refugee Committee was set up, under the presidency of statesman Herbert John Gladstone (1854–1930), and in many smaller cities and in the country local subcommittees were also set up. The subcommittees also took care of the refugees and sought to house, clothe and provide for them.<sup>3</sup> The local committees were expected to inform the central WRC of the number of refugees they were receiving, the number of women and children, how much money they'd collected, how many refugees found work, and whether this was a temporary or a long term engagement.<sup>4</sup> The board for employment of the Belgians in Great Britain was also located

1 This article was first published as Caterina Verdickt, "The Case of Elisabeth De Saedeleer: The Influence of Welsh Hospitality in the Great War on Belgian Modernist Interior Design," *British Art Journal* 15, no. 3 (2015), 93–98.

2 Peter Cahalan, *Belgian Refugee Relief in England during the Great War*, (New York; London: Garland, 1982), 2–4 and 9.

3 Cahalan, *Belgian Refugee*, 50; Pierre Purseigle, "A Wave on to Our Shores': The Exile and Resettlement of Refugees from the Western Front, 1914–1918," *Contemporary European History* 16, no. 4 (2007), DOI: 10.1017/S0960777307004109, 431–432.

4 Report of the Local Committee, Department of Manuscripts, inv. no. ex 1176, National Library of Wales (or NLW), Aberystwyth.



Fig. 1. Belgian Refugees in Antwerp, 1914.  
Courtesy of Flanders Fields Museum.



Fig. 2. Fredo Franzoni,  
*The Landing of the Belgian Refugees*, 1915,  
oil on canvas, 212 x 284 cm.  
Courtesy of Folkestone Library,  
Folkestone Town Council.

in London, having its offices at Hotel Cecil, the Strand. In 1915, for instance, a large number of Belgians did not find employment and problems concerning their maintenance emerged.<sup>5</sup> Owing to the scattered events of the War, one cannot speak of a general logical and well conducted cultural policy. These artist-refugees went ashore in the UK and were then dispatched all over the country. They ended up in London, Glasgow, Devonshire...

However in Wales, the situation was completely different and one can affirmatively state that indeed a deliberate policy was pursued. To illustrate this we turn to the case of Elisabeth De Saedeleer (1902–1972).

<sup>5</sup> Emile Van der Velde, *Letter by Emile Van der Velde to Rev. E. Aman Jones, in name of 'Bureau pour la protection du travail Belge à l'étranger', November 9, 1915*, Department of Manuscripts, inv. no. ex 1176, NLW, Aberystwyth.

### How a Belgian Artistic Family Ended up in Wales

Elisabeth De Saedeleer, the second daughter of the prominent Belgian artist Valerius De Saedeleer (1867–1941), left her home shortly after the outbreak of the war. She and her family fled from Sint Martens Latem, a village near Gent, together with two other artists, Gustave van de Woestijne (1881–1947) and George Minne (1866–1941), and their families to Zeeland. There they were stranded in the small village of Sint Anna ter Muiden. Here they met Raphael L. Petrucci (1872–1917), an Italian with a French mother, who lived in Brussels as he was attached to the Solvay Institute. Before coming to Sint Anna ter Muiden Petrucci had just had a visit from Fabrice Polderman (1885–1948), a Belgian professor working in Cardiff. Polderman told Petrucci that Belgian artists were welcome in Wales.

Fabrice Polderman himself was sent by David Davies (1880–1944) of Aberystwyth with a specific message: 'invite Belgian artists into Wales, where they would not only be able to continue their work but also bring a specific talent to the Welsh people'.<sup>6</sup>

Confusion or a misunderstanding arose here, though, because the painters and their families believed they would go to Cardiff. They expected to meet up with friends such as painter Emile Claus (1849–1924) and writer Emile Verhaeren (1855–1916), but that never happened. This particularity is confirmed by writer Jozef Muls (1882–1961) and Emile Claus. Emile Claus a well-known Belgian painter, and also a refugee, ended up in London. He recalls fleeing the London noise and travelling to Cardiff in search of his friends, Minne, De Saedeleer and Van de Woestijne. But 'I did not find my friends' testified Claus to Jozef Muls, a Belgian professor who lived in Oxford during the war.<sup>7</sup>

Now in order to get this company of Belgian artists to Aberystwyth, another friend of the Davies family, Professor Herbert John Fleure (1877–1969) – a professor in Geography, Anthropology and Zoology at the University of Aberystwyth – was sent to London to await the three families at Euston station then accompany them to make sure they arrived safely. So to their great surprise the families ended up in Aberystwyth and not in Cardiff, as Gustave van de Woestijne wrote to his friend Jozef Muls.<sup>8</sup>

Nevertheless, the arrival of the Belgian artists was mentioned enthusiastically in the local newspapers of 7 October 1914:

<sup>6</sup> Moira Vincentelli, "The Davies Family and Belgian Refugee Artists and Musicians in Wales," *The National Library of Wales Journal* 22, no. 2 (1981), 228–230.

<sup>7</sup> Jozef Muls, *Het rijk der stilte: De kunst en de oorlog*, (Antwerpen: Maatschappij voor goede en goedkope lectuur, 1920), 91–92; Cyriel Buysse, *Emile Claus, mijn broeder in Vlaanderen*, (Gent-Bussum, s.d.), 31.

<sup>8</sup> Gustave Van de Woestyne, *Letter by Gustave Van de Woestyne to Jozef Muls, June 2, 1915*, Box Gustave van de Woestyne, inv. no. 16 284 Koninklijke Musea voor Schone Kunsten Brussel (or KMSKB), Brussels, Archief voor Hedendaagse Kunst in België (or AHK).



Fig. 3. Exhibition of Belgian Art 1915. Courtesy of NMGW Cardiff.

A contingent of Belgian refugees reached Aberystwyth on Saturday by the express train from Euston and received a hearty welcome by inhabitants... It is stated that the adults are distinguished professional teachers, musicians and painters of a high station in life.<sup>9</sup>

Why were these Belgian artists so desired in Aberystwyth? The answer to this question has to be sought with the Davies family of Aberystwyth: David, Gwendolyn (1882–1951) and Margaret Davies (1884–1963) were the grand-children of David Davies (1818–1890), a Victorian industrialist. The sisters became philanthropists who used their fortune derived from mining to support Welsh social and cultural life. They were interested in the arts, music, literature and education. At the beginning of the war, the Davies family decided to invite Belgian artists in Wales to stay there. They saw an opportunity in the War events and hoped to inject local cultural life with the expertise of the Belgians.<sup>10</sup>

According to Vincentelli, Gwendolyn wrote to J H Davies in October 1914:

My sister and I together with Professor Tom Jones went to Alexandra Palace the week before last in search for refugees. Our original intention was to get people of the artisan or trades people class but we found that Roman Catholics are most vigilant and are preventing these people as far as possible from being taken into protestant homes [sic].<sup>11</sup>

9 Vincentelli, "The Davies Family," 226, where she quotes *Aberystwyth Dispatch*, *Cardigan Bay Visitor* and *Directory*, 7 October 1914, 1, col. 8.

10 Carolyn Stewart, "Een experiment in cultuurbeleid: Het mecenaat van Gwendoline en Margaret Davies en de Belgische kunstenaars in Wales 1914–1918," in Robert Hoozee, Caterina Verdickt and Eric Rowan, *Kunst in Ballingschap: Vlaanderen, Wales en de Eerste Wereldoorlog* (Gent: Pandora, 2002), 40–45.

11 Vincentelli, "The Davies Family," 226, where she quotes Gwendoline Davies, *Letter by Gwendoline Davies to J.H. Davies, October 4, 1914*, Department of Manuscripts, J. H Davies MSS, M 1991, 30, National Library of Wales, Aberystwyth.

This tension caused by the differences between Catholics and Protestants, between the hosts and the guests was significant. John Vyrnwy Morgan (1860–1925) wrote about the Belgian Refugees in his chapter "Belgians in Wales" in *The War and Wales* (1916). He elaborates on the noble nature of the Welsh, on the racial inferiority of the Belgians, especially concerning the religious differences between the Belgians and the Welsh. He states explicitly that the Belgians are indeed inferior to the Welsh.<sup>12</sup>

The Davies' tried to overcome these religious and social differences and as stated before, aimed at inserting into Welsh art the influence of the invited Belgian artists, so that a much desired Welsh artistic revival could be initiated. They had socio-cultural and politic motives for promoting Welsh art, as a nationalistic art, in order to revive it. The sisters had already organized an exhibition in 1913 at the National Museum and Galleries in Cardiff.

With this Loan Exhibition, where their art collection was presented to the public, they wanted to show high quality art to the public in the hope of inspiring that public. In the same spirit they sought to attract the Belgian artists. Gwendoline wrote to Thomas Jones (1870–1955) that she was very hopeful and that she anticipated that great things would happen in Wales.<sup>13</sup>

In 1915 an Exhibition of Belgian art, which travelled through the UK and was shown in Cardiff, can also be seen in the same philosophy (Fig. 3). This exhibition was held in cooperation with Sir William Goscombe John (1860–1952) (Fig. 4). John was a member of the board of directors of the National Museum and saw to it that the mentioned exhibition came to Wales.<sup>14</sup> From October 1914 many exhibitions with Belgian art were being held throughout the country. These exhibitions were held in order to raise awareness of the Belgian cultural heritage and to show at the same time what kind of culture the Germans were destroying on the continent. For instance, an Artists War Fund exhibition was held at Dicksees in London, 7 Duke Street. The aim of this expo was to raise funds for the Prince of Wales National Relief fund. Frank Brangwyn (1867–1956) and George Clausen

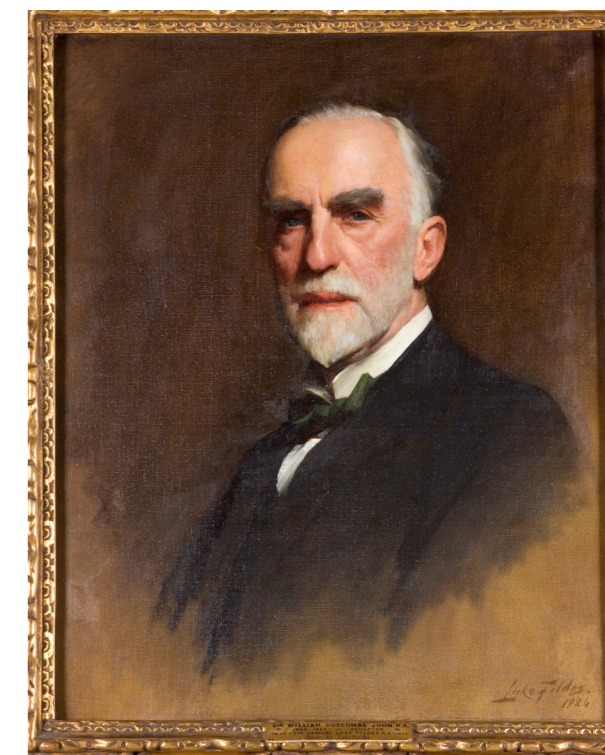

Fig. 4. Samuel Fildes, *Sir William Goscombe John*, 1924, oil on canvas, 67,6 x 55,2 cm. Courtesy of NMGW Cardiff.

12 John Vyrnwy Morgan, *The War and Wales* (London: Chapman & Hall Ltd., 1916), 160.

13 Oliver Fairclough (ed.), *Things of Beauty. What Two Sisters Did for Wales* (Cardiff: National Museum of Wales, 2007), 62–63.

14 Eric Rowan, "Kunst in Wales rond 1900," in Hoozee, Verdickt and Stewart, *Kunst in Ballingschap*, 26–27; Stewart, "Een experiment," 48.

(1852–1944) contributed to this show.<sup>15</sup> In November 1914 a first collective exhibition of “Belgian Masterpieces” in London was held. This time the show was set up in specific aid of Belgian artists in need. Over 100 works of art made by well-known artists were on show at Mac Lean Gallery at 7 Haymarket. These works of art were smuggled in to Britain and passed through German lines, the article in the newspaper mentioned.<sup>16</sup>



Fig. 5. Valerius De Saedeleer and family in front of Tynlon. Courtesy of Archives Businarias Maarkedal.

In Aberystwyth at the beginning of the War a special committee was organized for the Belgian war refugees. This illustrates that the ideas of the Davies’ were being supported by the town’s inhabitants. The first meeting of this committee was held on 28 October 1914, in the city hall. They agreed to meet on a weekly basis on Mondays, hence showing their engagement. The committee housed 130 Belgian refugees in Aberystwyth, among them some renowned Belgian musicians, who gave 22 concerts during the first year of their exile period, thus realizing another cultural dream of the Davies sisters.<sup>17</sup>

The Davies sisters generously housed their artist-refugees- guests, who were warmly welcomed. The Minne family and van de Woestijne family were housed in Llanidloes. The De

Saedeleer family was happy to stay in a house called Tynlon in Rhydyfelin (Fig. 5). The father Valerius started working immediately after his arrival and quickly established himself in the art circles of Aberystwyth.

### Reaction of the Public on the Arrival of the Belgians in Aberystwyth

The *Welsh Outlook*, a magazine founded and financed by David Davies in order to focus on Welsh cultural life, published an article on the arrival of the Belgian artists:

Probably no part of the Kingdom outside London, has so many distinguished Belgians among its guests as are now to be found in Wales. At their head stand [sic.] Emile Verhaeren, who is

staying at Llynarthan. A few miles away at Barry is Emile Claus, Belgium’s best known painter. At Aberystwyth we have another able sculptor M. Minne... with him at Aberystwyth De Saedeleer, Van der Woostyne (sic) and L. Petrucci – all well-known names in art circles on the continent.<sup>18</sup>

As stated before, the presence of these artists was seen as a good opportunity to enhance Welsh cultural life. Vincentelli identified the author as Fabrice Polderman, a Belgian professor who had secured a position at the university college in Cardiff. Gustave van de Woestijne would later paint his portrait during the War while Polderman lives in Birmingham. The editor Thomas Jones, who was a good friend of the Davies family, spent a few days in Belgium in September 1914 together with Fabrice Poldermans and W. J. Burdon Evans.<sup>19</sup>

Yet, and this was also mentioned by Vincentelli, Polderman wrote in the *Welsh Outlook*:

The study of painting and sculpture is in a deplorably backward condition in Wales. Shall we take full and immediate advantage of the unexpected presence in our midst of this brilliant group: take counsel with them: give them facilities to exercise their genius: give our young art students the chance of seeing them at work? What will the three colleges do? And the Art Academies? And the Art Schools? The opportunity is unique but we may be too parochial to seize it.<sup>20</sup>

### How Did the Family Maintain Itself?

Of course the family needed to adjust to their new environment, but from the beginning of 1915 Valerius De Saedeleer wrote positively to his friend about his Welsh situation: ‘I am working quite well here. I have my family with me in a beautiful country and a nice home, I am as happy as I can be, far away from Flanders and the horrible war.’<sup>21</sup> The addressed friend is Jozef Muls who was at that time living in Oxford, where he in turn maintained himself in the best of ways. He too organised an exhibition of modern Belgian arts, and for this he invited Valerius De Saedeleer to send some new Welsh works. *The Vale of the Reidal, Tancastell Farm, Sweet solitude of Cardigan* and

<sup>15</sup> *Standard*, October 28, 1914.

<sup>16</sup> *Daily Telegraph*, November 24, 1914; Paul Buschmann, “Belgian Artists in England, second article,” *The Studio: An Illustrated Magazine of Fine and Applied Art* 67, no. 263 (February 1915), 46.

<sup>17</sup> Members of the committee were Miss Palchett, Gwendoline Davies, Mrs. Mendham, Mrs. Morgan, Mrs. Parr, Mrs. Morris, Mrs. Denton, and Mr. E D Jones as the secretary, Reverend Falker Wilcock, Mr. Rhys Jones, Mr. Williams, Reverend PH Lewis and Chairman Rees Jones. This committee received a letter from the Belgian born Mr. Laoureux, who stayed in Aberystwyth asking the committee whether they could shelter the family of the Belgian composer Dupuy. Minutes of the meetings of the Belgian Refugee Committee, Department of Manuscripts, M, MS 2639c, NLW, Aberystwyth.

<sup>18</sup> F.B., “Notes of the Month,” in *The Welsh Outlook* 1, no. 11 (November 1914), 457, quote has been published by Vincentelli, “The Davies Family,” 227.

<sup>19</sup> Vincentelli, “The Davies Family,” 228.

<sup>20</sup> F.B., “Notes of the Month,” 457.

<sup>21</sup> Valerius de Saedeleer, *Letter from Valerius de Saedeleer to Jozef Muls, April 15, 1915*, Archief en Museum Vlaamse Cultuurleven - Letterenhuis, Antwerp dossier S 1155.



Fig. 6. Valerius De Saedeleer, Marie Joseph, their friend Louise and Monica on Aberystwyth beach. Courtesy of Archives Businarias Maarkedal.

*Recollection of Beautiful Flanders* were first shown to the public at this exhibition. He sold the first three of the four works.<sup>22</sup>

In Aberystwyth itself Valerius De Saedeleer became somewhat of a local celebrity (Fig. 6). Valerius De Saedeleer paid many bills with his paintings. He had personal exhibitions from 1916 onwards. In February 1916 he exhibited his work in Alexandra Hall at the university college. He also worked as assistant to the drawing master of the university Daniel Rowland Jones (1875–1924).

In 1918 Valerius was also appointed as the future head of the arts and crafts centre, which was another project of the Davies sisters. The founding of the centre had been an idea of Professor

Fleure and the Davies sisters, who donated 5000 pounds towards it. Their main goal was to establish a centre for the arts and crafts in the heart of Wales. Their project was supported by Thomas Jones, who would be assistant secretary of the new coalition cabinet in 1916, and by David Davies, who became private secretary to Premier Lloyd George (1863–1945) in 1916.<sup>23</sup>

Initially the Davies sisters put a lot of effort and energy into the Belgians but after a while they redirected their war interests towards more political and social activities. They volunteered as nurses and worked for several years in a canteen in Troyes.<sup>24</sup> However, their efforts did have their merits and did affect cultural life indirectly. This was especially true of the daughters of Valerius De Saedeleer.

Marie and Elisabeth De Saedeleer learned their techniques in Wales. They met a former employee of William Morris (1834–1896), who suggested that the girls should take up weaving.<sup>25</sup> The second daughter, Elisabeth, would get acquainted with Mary 'May' Morris (1862–1938), who also trained her in tapestry weaving. It is unclear whether she met with Mary Morris in London or in Wales. But several sources mention their acquaintance.<sup>26</sup>

22 Valerius de Saedeleer, *Letter from Valerius de Saedeleer to Jozef Muls, April 23, 1915*, Archief en Museum Vlaamse Cultuurleven - Letterenhuis, Antwerp, S 1155; *Exhibition of Belgian Art* (Oxford, 1915), 5.

23 Stewart, "Een experiment," 50; Herbert John Fleure, *Letter by Professor to Thomas Jones, October 10, 1918*, DM, Thomas Jones Papers, CLASS W 7, no. 26, NLW, Aberystwyth, quoted by Vincentelli, "The Davies Family," 233.

24 Stewart, "Een experiment," 51.

25 Luc Haesaerts, "De Tapijtkunst van de gezusters De Saedeleer," *Onze Kunst: Geïllustreerd maandschrift voor beeldende en decoratieve kunsten* 22, no. 9–10 (1925), 45; Vincentelli, "The Davies Family," 231.

26 Susan Day, *Art Déco and Modernist Carpets* (London: Thames and Hudson, 2002), 63; Elisabeth De Saedeleer, *De Handweefkunst: Het Kunstatelier Elisabeth De Saedeleer* (Brussel: Het Kunstatelier, 1974), 6; Jean Teugels, "Le Studio De Saedeleer," *Sélection: Chronique de la vie artistique et littéraire* 5, no. 4 (1926), 276; Elsje Janssen, "Creating Textiles in Belgium during the 20th Century: A Large Weaving Manufacturer, a Small Textile Studio and a Contemporary Textile Designer," in *Creating Textiles: Makers, Methods, Market: Proceedings of the Sixth Biennial Symposium of the Textile Society of America, Inc. New York, NY, September 23–26, 1998* (Earlville, MD: Textile Society of America, Inc., 1999), 267; Ingrid De Meuter, *Kleur voor wand en vloer: Het weefatelier Elisabeth de Saedeleer (1902–1972)* (Oudenaarde: Stad Oudenaarde, 1993), 11.

After a while the girls work became successful, so much so that Valerius de Saedeleer thought about starting a training centre for tapestry weaving. Thus professor Fleure wrote to Thomas Jones in October 1918: 'The De Saedeleer family could really organize weaving a winter work for a village and would like to do so.'<sup>27</sup>

In this period Valerius De Saedeleer and his family met Jacob de Graaff (1873–1947), a wealthy Dutch entrepreneur who resided in London during the War and who collected many works of art by Belgian artists. De Graaff previously met Gustave van de Woestijne at an exhibition in London in 1916. Before De Graaff met the Belgian artists, he was keen on nineteenth century French art. However, after meeting Hippolyte Daeye (1873–1952), Léon De Smet (1881–1966) and Gustave van de Woestijne in London, he learned about modern art and specifically modern Belgian art. Because of this acquaintance De Graaff bought work from Constant Permeke (1886–1952), Van de Woestijne and De Saedeleer during the war. He in return introduced the Belgian artists to London Society, bought them tickets to the theatre and took them out. He took Gustave Van de Woestijne, for instance, to see the show 'Baby's in the Wood'.<sup>28</sup> It is Gustave van de Woestijne who introduced Valerius De Saedeleer to Jacob De Graaff late 1918. He wrote in a letter to De Graaff that De Saedeleers work was on show at the Grosvenor Gallery in New Bond Street and in the same letter he asked if De Graaff would mind viewing his friend's work and if possible buying one.<sup>29</sup>

From the beginning of 1919, De Saedeleer started a written correspondence with De Graaff himself. He invited De Graaff to an exhibition in Aberystwyth of his work and that of his daughters, who made tapestries after the design of their father.<sup>30</sup> Whether De Graaff made the journey to Aberystwyth to see the exhibition is unclear but he did invite the girls to London not much later. In February 1919, Jacob De Graaff invited the De Saedeleer sisters to visit him at his London house. Gustave van de Woestijne, who was Elisabeth's godfather, agreed to accompany them on their trip which was planned for March 1919.<sup>31</sup> De Graaff helped them out on several occasions by investing in their art and craft, so that they could buy supplies, thus responding to De Saedeleer's plea for

27 Herbert John Fleure, *Letter from professor to Thomas Jones, October 10, 1918*, DM, Thomas Jones Papers, Class W, vol. 7 letter 26, NLW, Aberystwyth, quoted by Vincentelli, "The Davies Family," 231 and 233.

28 André Kraaeyenga, *De collectie De Graaff- Bachiene: Schilderijen, beeldhouwwerken, tekeningen en grafiek* (Heino: Hannema-de Stuersfundatie, 1992), 11.

29 Jacob de Graaff was a close friend of David Van Buuren, they met on a regular base at the Le Centaure and Giroux Galleries in Brussels, see Françoise Lechien Durant, *Museum David en Alice van Buuren: Huis van herinneringen* (Tielt: Lannoo, 1995), 101; Gustave van de Woestijne, *Letter from Gustave van de Woestijne to Jacob De Graaff, November 19, 1918*, Dossier Gustave van de Woestijne, inv. no. 50 716, KMSKB, Brussels, AHK.

30 Valerius de Saedeleer, *Letters from Valerius de Saedeleer to Jacob De Graaff, January 28, 1919*, Dossier Valerius de Saedeleer, inv. no 50 599, KMSKB, Brussels, AHK.

31 Gustave Van de Woestijne, *Letter from Gustave Van de Woestijne to Jacob De Graaff, February 20, 1919*, Dossier Gustave van de Woestijne, inv. no. 50 722, KMSKB, Brussels, AHK.



Fig. 7. Gregynog, home of Gwendoline and Margaret Davies.  
Courtesy of Collection Rhian Davies.

help. De Saedeleer had been writing that Marie had already been working under commissions for a couple of months, yet in unbearable circumstances.<sup>32</sup>

In April 1919 the University of Aberystwyth held festivities, during which Valerius De Saedeleer exhibited his work. This event was successful; in addition the daughters' work was sold. Later on Valerius De Saedeleer reported that his daughters' had almost enough orders to work completely independently. At that time they all were quite enthusiastic and positive about the weaving activities and the new arts and crafts centre in Aberystwyth. Later on, in 1920, Valerius De Saedeleer decided to ask Jacob De Graaff for a loan, since at this point the family still wanted to stay in Wales and invest in their lives and work there.<sup>33</sup>

Professor Fleure wrote to Miss Davies on 16<sup>th</sup> March 1920: 'If the De Saedeleer family wants to stay I am only too glad to agree. They are valuable to the country. On the other hand I cannot urge them to stay under the circumstances created by Thomas Jones [sic.] non-election.'<sup>34</sup>

Progress in the establishment of the centre for weaving techniques was difficult: Valerius De Saedeleer wanted to wait and initially did not want to return to Belgium. Yet the Centre never achieved its full promise: Valerius De Saedeleer had been promised the position of head, but that did not happen because one of the initial founders, Thomas Jones was not re-elected and so the

Centre lost one of its principal advocates. The plans for establishing the centre of arts and crafts in Aberystwyth were delayed yet again and so Valerius De Saedeleer decided to move back to Belgium. Professor Fleure also stated that it was for this reason that Valerius De Saedeleer left Aberystwyth.

A year later the Davies sisters went to live in Gregynog Hall (Fig. 7), in Montgomeryshire, with the original intention of turning it into a rural centre for arts and crafts. By funding the establishment of both a Department of Art and an Arts and Crafts Collection at The University of Wales, Aberystwyth, the sisters envisaged that the two ventures would lead to an arts and crafts revival for Wales.<sup>35</sup>

### Back in Belgium

When the De Saedeleer family moved back to Belgium in 1921, they established themselves in Etikhove and named their new home Tynlon after their Welsh one. The first project they undertook was the founding of an arts and crafts centre in Etikhove, which would become a centre of weaving techniques in the Modernist Belgian era, thus building on what they had learned in Wales.

The tapestry studio was set up next to their father's atelier and initially Marie and Elisabeth took charge of the workplace together, but Marie De Saedeleer stopped her weaving activities due to personal circumstances Luc Haesaerts wrote, although he did not specify what those were.<sup>36</sup>

The studio was organised along the lines directly derived from the Arts and Crafts movement wrote Susan Day.<sup>37</sup> Elisabeth would transfer the designs to the actual size required and painted the sample cards herself. At this atelier she started working with the designs of artists such as Edgar Tijtgat (1879–1957) and Gustave van de Woestijne -Zon (Fig. 8) and Schaal (Fig. 9) for instance-, and of architects such as Albert van Huffel (1877–1935), who had been commissioned to contribute to the reconstruction of Belgium. In the tapestry made in this period many flora and fauna motifs were used, as were vivid colours and butterflies - for example *Spring* by Albert Van Huffel.<sup>38</sup>

Elsje Janssen judged that her use of central lockets and arabesques can be compared with textiles designed by, and show the influences of the traditions of William Morris and the Arts and Crafts weaving techniques.<sup>39</sup> In 1925 Belgian art critic Luc Haesaerts commented in *Onze Kunst* on the De Saedeleer tapestry on show in Gallery Renis in Antwerp from 27 December 1924 to 15 January

32 Valerius de Saedeleer, *Letters from Valerius de Saedeleer to Jacob De Graaff, February 25, 1919 and March 29, 1919*, Dossier Valerius de Saedeleer, inv. no. 50 600 and 50 602, KMSKB, Brussels, AHK.

33 Valerius de Saedeleer, *Letters from Valerius de Saedeleer to Jacob De Graaff, March 4 1919 and January 29 1920*, Dossier Valerius de Saedeleer, inv. no. 50 601 and 50 614, KMSKB, Brussels AHK.

34 Herbert John Fleure, *Letter from Professor Fleure to Miss Davies, March 16, 1920*, T Jones Papers, Class W Vol. 7, 68, NLW, Aberystwyth, quoted by Vincentelli, "The Davies Family," 233.

35 Stewart, "Een experiment," 52; Fairclough, *Things of Beauty*, 82–89.

36 Luc Haesaerts, "De Tapijtkunst van de gezusters De Saedeleer," *Onze Kunst* 42, no. 9–10 (1925), 46.

37 Day, *Art Decò*, 63.

38 N.N., "Vlaamse Tapijtwefkunst van de gezusters De Saedeleer," *Elseviermaandschrift*, no. 1 (1926), 149–150; Nairy Vrouyr, *Art Déco* (Antwerp: Vrouyr, 2010), 17.

39 Janssen, "Creating Textiles," 267.



Fig. 8. Gustave van de Woestijne, ex. by Elisabeth De Saedeleer, *Zon*, 1925, cellulose and wool, 172 x 212 cm. Courtesy of Collection Vrouyr Antwerp.



Fig. 9. Gustave van de Woestijne, ex. by Elisabeth De Saedeleer, *Schaal*, 1925, cellulose and wool, 103 x 169 cm. Courtesy of Collection Vrouyr Antwerp.

1925.<sup>40</sup> In the next edition of *Onze Kunst*, Haesaerts devotes a complete article to the art of the sisters. He explains their origins, techniques, design and innovations. In the same article, Haesaerts elaborates on the techniques the sisters employed and of their novelty compared to the old weaving techniques.<sup>41</sup>

During the 1920s and 1930s –the Modernist years par excellence– the studio of Elisabeth De Saedeleer and her sisters' became well known for their vivid and colourful knotted floor coverings, mural carpets and fabrics for scarfs and table cloths.<sup>42</sup> Studio de Saedeleer searched for the ideal formula for the design of tapestry: a floor carpet is, according to them, a component of the entire interior design and has to fit in as such. They did not see a tapestry as a separate independent work of art. The bases for the composition of design are the measurements and the tightness of the knots. Elisabeth worked in a pictorial manner creating depth by using colour.<sup>43</sup>

The demure carpets were knotted and not inlaid as was customary in Flemish traditions. The sisters used by preference vertical weaving looms because they offered more control. Haesaerts describes the used techniques exhaustively in his article.<sup>44</sup>

40 Luc Haesaerts, "Tapijten der juffrouwen De Saedeleer," *Onze Kunst* 41, no. 1–2 (1925), 70–80.

41 Haesaerts, "De Tapijtkunst van de gezusters," 45–58.

42 Janssen, "Creating Textiles," 267.

43 De Meuter, *Kleur voor wand*, 12.

44 Haesaerts, "De Tapijtkunst van de gezusters," 47–51.

Karel Van de Woestijne, a contemporary renowned art critic had also visited the studio and wrote in positive words about the art of the daughters of Valerius de Saedeleer.<sup>45</sup> 'A good carpet is not a personal victory: it is in essence a designated enrichment of a beautiful interior, equally to a piece of furniture, a platter or a well cut mirror.'<sup>46</sup>

Haesaerts reflected on the novelty of these tapestry and judged imported tapestry from the east to be the remains of the past, from a time that had lost all sense for architecture and decorative arts. Architecture had become an art of adjusting style upon style, he wrote and when decorating a house one would apply every one of those styles. Tapestry also suffered from this crisis of logical and constructive impotence. But after the war things changed wrote Haesaerts. 'Our Time will have its own style; midst searching and errors/failing we'll see her grow and first and foremost she seems to be logical.'<sup>47</sup>

The De Saedeleer carpets used to be very highly esteemed. They made six pieces of every design. Each carpet had its own number and the signature of the designer and of the maker/ the sisters.<sup>48</sup> Elisabeth's work was installed in the famous National Basilica of the Sacred Heart of Koekelberg designed by Albert Van Huffel, one of Belgium's most famous art deco monuments. In her career Elisabeth made tapestry after the designs of artists such as Ossip Zadkine, Michel Seuphor, Marc Chagall and André Llothe.<sup>49</sup> 'Quelle est en Europe la firme qui puisse se targuer d'avoir mis sur pied un catalogue si brillant?' wrote Georges Marlier in *Art et Décoration* in 1928.<sup>50</sup> 'A l'heure où la jeune peinture belge suscite partout une légitime admiration, l'activité du Studio De Saedeleer vient enrichir d'un apport précieux le tableau de la vie artistique en Belgique.'<sup>51</sup>

In 1927 Elisabeth De Saedeleer was asked by founding director Henri Van de Velde to teach at La Cambre, one of the major art and designs schools in Belgium. Here she found herself in the core

45 'Er zijn ontwerpen van Elisabeth de Saedeleer, die mooie schilderijen maakt; er zijn aanminnige ontwerpen van haar jongste zuster, de pas veertienjarige Godelieve; er zijn aristokratische van Gustaaf van de Woestijne en Assyrische, maar toch zoo leuk-Vlaamsche van den jongen beeldhouwer Leplae; er zijn geestig-fantastische van Edgard Tytgat enforsch-decoratieve van Jules Boulez; er zijn ontwerpen van den rechtstreeksche medewerker van de juffrouwen De Saedeleer, den kunstcriticus Paul Haesaerts, die bewijst, dat hij de techniek van het tapijtweven meester is; er is er een - en dat zal u genoeg doen - van Jan Sluyters, dat eerlang wordt uitgevoerd,' in Karel Van de Woestijne, *Verzameld journalistiek werk: Nieuwe Rotterdamse Courant september 1925 – november 1926*, edited by Ada Deprez (Gent: Cultureel Documentatiecentrum, 1994), vol.14, 151–152.

46 'Een goed tapijt is niet eene persoonlijke overwinning: het is hoofdzakelijk de aangewezen verrijking van een schoon intérieur, net als een meubel, een schotel, een goed-geslepen spiegel,' in Van de Woestijne, *Verzameld journalistiek werk*, 150.

47 'Onze tijd zal zijn eigen stijl hebben; temidden van het gezoek en de vergissing zien we hem stilaan opgroeien, en hij schijnt in de eerste plaats logisch te willen zijn,' in Haesaerts, 'De Tapijtkunst van de gezusters,' 53.

48 Haesaerts, 'De Tapijtkunst van de gezusters,' 57.

49 De Meuter, *Kleur voor wand*, 22 and 81.

50 Georges Marlier, "Les tapis De Saedeleer," *Art et Décoration: Revue mensuelle d'Art Moderne* (September, 1928), 84.

51 Marlier, "Les tapis De Saedeleer," 88.



Fig. 10. Elisabeth De Saedeleer at La Cambre, second lady from the right, 1927.

Courtesy of Collection A. AM. Brussels.

of the Belgian artistic modernist life of the 1920s and 1930s (Fig. 10). She became colleagues with her godfather Gustave van de Woestijne and with Albert Van Huffel who were also teaching at La Cambre. She was in charge of the textile program: where she taught cloth, floor and mural tapestry thus taking up what she had learned in Wales and transferring it to her students.

### Caterina Verdickt

Antwerp University – Faculty of Design Sciences



Caterina Verdickt is an art historian and conducting a Phd, *The Realm of Silence. Consequences of the Belgian artistic migration towards Great Britain during the Great War on post war Belgian interior design*, at the University of Antwerp. She was co-curator of the W. H. Berger Prize nominated exhibition "Art in Exile. Flanders, Wales and the First World War", when she worked at the Museum of Fine Arts in Gent for Robert Hoozee. She has been liason officer for the Vlaamsekunstcollectie in Belgium. At the moment she teaches History of Interior Design 1850–1950 at the Faculty of Design Sciences, Antwerp University.

E-mail: [caterina.verdickt@uantwerpen.be](mailto:caterina.verdickt@uantwerpen.be)

## Dahl Collings (1909–1988) and Her Itinerary: Australia, England, and Back

Dahl Collings (1909–1988) actively contributed to the arts in Australia in the twentieth century through her engagement in a variety of fields and projects worldwide; surpassing cultural, geographical, social, artistic, and cultural borders. An active traveler, she often visited and worked in Europe, eventually working with Bauhaus Masters László Moholy-Nagy and György Kepes in London. At Simpson's Department store, the trio innovatively used window displays and retail virtual merchandising as a platform to evoke the Bauhaus spirit. Also an evocation of the Bauhaus was Collings' interest in the unity of all arts with her artistic range and interest in painting, commercial art, illustration, costume design, textile design, exhibition design, photography, and film. Through an analysis of various works, I aim to demonstrate Collings' cosmopolitan approach to art and her subsequent achievements that have unfortunately been marginalized or largely neglected.

Keywords: Australia, Dahl Collings, London, Simpson's Department Store, László Moholy-Nagy

Dahl Collings's cross-disciplinary devotion to artistic production situates her in the modernist realms of painting, commercial art, illustration, fashion, textile design, costume design, exhibition design, photography, and film. The aim of this paper is to trace Dahl Collings' overseas experience in London to demonstrate how she was transformed from active participant to active exponent of Modernism during the 1930s, an extremely challenging time to be both female and an advocate of a modernity that Australia viewed as a 'foreign disease'.<sup>1</sup> While existing scholarship surrounding Dahl Collings is due to the impressive work and effort of scholars such as Geoffrey Caban, Michael Bogle, and Anne Marie Van de Ven, my paper aims to assert Dahl Collings as a symbol of modernity by providing an analysis of her identity as a modern female artist, of her involvement in London with London serving as a crucial site of Modernity in itself, and of her contribution to Australia's Modernism as a result of her adoption of a Bauhaus aesthetic.

Dahl Collings, born as Dulcie Wilmott in Adelaide in 1909, began her art studies at East Sydney Technical College from around 1926–32 and took various painting courses at the J.S. Watkins Art School, earning a scholarship from the Society of Artists while focusing on portraiture.<sup>2</sup> At the time of her enrolment, East Sydney Technical College was modelled around the nineteenth century British concentration of tradition,<sup>3</sup> and like the rest of Australia, faced modernism with much hesitance. After finishing her art education, at the age of eighteen Collings was granted her first job at Anthony Horderns, a big department store.<sup>4</sup> Illustrative as an early example of her ambition, she had 'walked from store to store with her portfolio of drawings',<sup>5</sup> until she impressed Horderns as well as other department stores like Farmers and David Jones, for which Collings completed freelance work. Shortly after, in 1933, she met and married fellow Australian Geoffrey Collings (1905–2000), also an advocate of modernism and with whom she would collaborate throughout her entire artistic career.

1 Helen Topliss, *Modernism and Feminism: Australian Women Artists, 1900–1940* (Roseville East: Craftsman House, 1996), 110.

2 Anne-Marie Van De Ven, "Dahl Collings b. 1909," Design and Art Australia Online, <https://www.daa.org.au/bio/dahl-collings/biography/> (accessed August 12, 2015).

3 Topliss, *Modernism and Feminism*, 29.

4 Geoffrey Caban, *A Fine Line: A History of Australian Commercial Art* (Sydney, NSW: Hale & Iremonger, 1983), 70.

5 Ibid.

Geoffrey Collings was not a well-known figure in the Australian art scene when he and Dahl met, and it has been only recently that there has been more revived interest in his work.<sup>6</sup> Educated in Brisbane, before he met Dahl and while they both lived in Sydney, he worked odd jobs such as sweeping floors, running messages, delivering blocks, matrixes, and stereos.<sup>7</sup> Nevertheless, Geoffrey Collings used the job experiences to get close to newspaper equipment and he was able to gain experience in linotype and production procedures while performing his menial tasks.<sup>8</sup> Eventually, he was able to get hands-on experience, and finally acquire, the technical knowledge necessary to understand the process of printing plates. Together, these various professional experiences would later intrigue his London employers and serve as a ground for his employment.

### London as a Site of Modernity

In 1935, Dahl and Geoffrey Collings would embark for London,<sup>9</sup> a city which Australians considered as being full of opportunity. Described as the 'strongest magnet to all the peoples of the earth' London itself as a city, as a physical site of modernity and possibilities was, furthermore, perceived by Australians as 'as a metropolis representing the arts and urban opportunity,' that seemed to be lacking in Australia and as a 'central locus, the destination before, after, or in between any other travels.'<sup>10</sup>

The voyage to London alone is worthy of remark – it was an exemplary of the modern through the association with mobility, channels of transmission and transfer, and industrialisation of travel. A travel distance of over 10,000 miles, London was a significantly impressive trip amongst Australians. As stated by Angela Woollacott, 'reports of those in London regularly appeared in Australian newspapers and magazines, imbuing a London sojourn with celebrity status.'<sup>11</sup> This certainly can be seen in the newspaper articles that featured Dahl Collings and her husband that helped promote a stronger presence back at home in Australia.

Upon arrival in London, through determination and hardwork, Geoffrey Collings was able to get work as art director of the American advertising agency, Erwin Wasey & Co. Dahl Collings was able to do a variety of freelance jobs consisting of murals, fashion illustrations, and exhibitions for top fashion

magazines such as *Vogue* and *Harper's Bazaar*.<sup>12</sup> It allowed her to reach a significant female audience due to the popularity of these publications, as well as inspire Australian women back home with her fashion sense. Collings' interest in fashion was obvious with her designs as well as in her own personal taste in clothing that demonstrated her preference for sophisticated pieces reflective of her cosmopolitan lifestyle (Fig. 1). She often designed her own wardrobe.<sup>13</sup>

And it was perhaps this interest in fashion that resulted in Dahl Collings' involvement with Simpson Piccadilly, a circumstance that would later prove critical for her artistic development and contribution to the arts in Australia.



Fig. 1. Geoffrey Collings, Dahl Collings, ca. 1935–37. Courtesy of Museum of Applied Arts and Sciences, Sydney, 2007/30/1-69/2/60 (00236773).

### Simpson Department Store as a site of Modernity

Simpson Piccadilly, which opened its doors on April 29 1936,<sup>14</sup> shortly after the Collings' arrival in London, was and is considered as one of architect Joseph Emberton's greatest works.<sup>15</sup> Physically, the architectural structure and appearance of Simpson was and is exemplary of modernity with its achievement of simplicity, functionality, and spaciousness. And while its sheer size immediately received the attention it merited, it was also its interior and excruciatingly thought-out details that made an even more astonishing impact.

Simpson offered the most modern of the modern; fulfilling whatever a customer could want with added convenience and luxury. The grand department store functioned as a modern icon that offered visitors one of the best views of London, the opportunity to purchase theatre tickets and travel tickets, a sports shop, a golf range, a gift shop, a flower shop, an air conditioned cigar shop, a barber's shop complete with a shoe shine boy, both a formal restaurant and a snack bar, grand tailoring departments that covered 40,000 square feet, a dog shop, and a tape machine that provided

6 Isobel Crombie, "A Documentary Impulse: Australian Photographer Geoffrey Collings," *Art Bulletin of Victoria* 29 (1991), <http://www.ngv.vic.gov.au/essay/a-documentary-impulse-australian-photographer-geoffrey-collings/> (accessed September 10, 2015).

7 Caban, *A Fine Line*, 70.

8 Ibid.

9 Van De Ven, "Dahl Collings b. 1909."

10 Angela Woollacott, *To Try Her Fortune in London: Australian Women, Colonialism, and Modernity* (Oxford: Oxford University Press, 2001), quotes on 4 and 9.

11 Woollacott, *To Try Her Fortune*, 4.

12 Caban, *A Fine Line*, 71.

13 "Making her Way in London," *The Australian Woman's Mirror*, October 7, 1936, Museum of Applied Arts and Sciences (or MAAS), Dahl and Geoffrey Collings Collection, 2007/30/1–14/1/2.

14 David Wainwright, *The British Tradition: Simpson-a World of Style* (London: Quiller Press, 1996), 25.

15 Rosemary Ind, *Emberton* (London: Scholar Press, 1983), 30.

the latest news and sports results.<sup>16</sup> Everything that could possibly be desired, most definitely was possible of being fulfilled in just this one elegant building.

And while it was grandiose and glamorous, every physical detail was designed to suit the specific needs of practicality; the white horizontal Portland strips in the makeup of the front of the building, for example, were specifically structured angularly to prevent less dirt and debris from reaching the building reducing the building's maintenance; the windows were designed to allow for a vastness of light and space; and the neon lighting functioned to properly illuminate the building and increase its presence at night. The building's inner components operated based on the same principle of functionality. Light fittings were hung in a manner that eliminated shadows on items within the store; the innovative vacuum system assisted with accounting and financial matters; and the computerized check out systems were designed with the convenience of the workers and the customers in mind. Children would stand at the check-out flabbergasted by the 'beep' noises that would follow each merchandise scan.<sup>17</sup> Moreover, the furnishings within the building were incredibly modern in themselves –from the ninety-foot chromium light fixture that was suspended down the entire main staircase of the store to the chromed metal chairs<sup>18</sup>– designs whose form and function can be seen as an influence of the Bauhaus aesthetic.

The actual merchandise that was being sold at Simpson, not surprisingly, was also representative of the most current fashion innovations that benefited the customer in terms of comfort, function, and overall appearance. The clothing pieces had an intricate modernity about them as they existed in an abundance of colours and fabrics during a period when men's wardrobes consisted of dull, dark clothing that oftentimes was not the most suitable or practical. Just as revolutionary was the electric shaver available –the first to be sold in Britain– and men's cotton underwear with the comfort of elastic that was a better alternative to the fussy and hot underwear made of wool that required linen tapes to be secured around the waist.<sup>19</sup> Most certainly, as stated David Wainwright, Simpson 'was in truth a revolution; and as [...] distinguished guests and colleagues in the trade toured the new store, they were breath taken by the audacity of it. Perhaps the lower ground floor caused the most comment, for the sheer variety of items on offer, many of them never before seen in men's outfitters.'<sup>20</sup>

The staff at Simpson was just as pivotal for its success and characterisation of modernity. Some of the most instrumental figures present were Bauhaus foundation instructor László Moholy-Nagy (1895–1946) and Hungarian artist György Kepes (1906–2001), also linked to the Bauhaus due to

his later involvement with the New Bauhaus in Chicago. Both had arrived in London with Bauhaus founder and prominent architectural figure Walter Gropius (1883–1969) seeking exile due to the turbulent political atmosphere surrounding Germany. Moholy-Nagy and Kepes were offered jobs at Simpson by Alexander Simpson himself, where they were responsible for display and product design.<sup>21</sup> Moholy-Nagy completely oversaw every detail and component related to the store's visual appearance 'from window displays to the weaving of cloths for the restaurant'.<sup>22</sup> Additionally, Hungarian-born Bauhaus artist Marcel Breuer (1902–1981) was also in contact with Alexander Simpson about producing furniture for the store, aspiring to one day complement Simpson with a Furniture Department<sup>23</sup> thanks in part to his connection with Moholy-Nagy who introduced him to Alexander Simpson.<sup>24</sup>

It was at Simpson that Dahl Collings was hired by Moholy-Nagy himself after he became impressed with the versatility in her work in which she incorporated watercolour, fabrics, and other materials in an innovative manner he hadn't seen before in any of his students' work at the Bauhaus.<sup>25</sup> She became the only female member of the international team that Moholy-Nagy put together<sup>26</sup> and she even managed to later convince Moholy-Nagy to allow fellow Australian, Alistair Morrison, to join the team. This resulted in Morrison immediately becoming interested in the Bauhaus attitude towards design after working with Moholy-Nagy as well<sup>27</sup> and later applying those principles once back in Australia.

According to Dahl Collings' personal reflections of her time at Simpson, for Moholy-Nagy, no detail was too small to overlook. 'Ok,' Moholy-Nagy would say, 'we're not just going to have the tablecloths yellow and order yellow tablecloths. We're going to think about it.'<sup>28</sup> Dahl Collings learned to apply this deep thinking and exploration of design possibilities within her own personal work, which according to Geoffrey Caban, involved the design of every item housed within Simpson, from the most mundane to the most intricate. She worked with 'furnishings, store graphics, fabrics, glassware, silverware, [and] even menus.'<sup>29</sup> According to Dahl Collings, because she had utilised

21 Sibyl Nagy, *Moholy-Nagy: Experiment in Totality* (Cambridge, Mass.: M.I.T. Press, 1969), 119.

22 Caban, *A Fine Line*, 72.

23 Alexander Simpson, *Letter from Alexander Simpson to Marcel Breuer, February 2, 1936*, 01825-001, 1936-02-03, Marcel Breuer Digital Archive, Syracuse University, <http://breuer.syr.edu/xtf/view?docId=mets/4889.mets.xml;query=alexander%20simpson;brand=breuer> (accessed September 12, 2015).

24 László Moholy-Nagy, *Letter from Moholy-Nagy to Alexander Simpson, February 3, 1936*, 00461-002, 1936-02-03, Marcel Breuer Digital Archive, Syracuse University, <http://breuer.syr.edu/xtf/view?docId=mets/2586.mets.xml;query=moholy-nagy%20simpson;brand=breuer> (accessed September 12, 2015).

25 Caban, *A Fine Line*, 71.

26 "Making her Way in London," MAAS, Dahl and Geoffrey Collings Collection, 2007/30/1-14/1/2.

27 Caban, *A Fine Line*, 73.

28 Caban, *A Fine Line*, 72.

29 Caban, *A Fine Line*, 70.

16 Wainwright, *The British Tradition*, 29–30.

17 Wainwright, *The British Tradition*, 29–33.

18 Wainwright, *The British Tradition*, 33.

19 Wainwright, *The British Tradition*, 28.

20 Wainwright, *The British Tradition*, 29.

watercolours to layer one colour over another, the overlapping of new colours led her to explore the visual intricacy of weaving. Consequently, she designed 'tablecloths to be woven for the restaurant,' as well as 'clothes for the clothing department that were accepted and manufactured, window displays and many other things such as labels for tobacco tins.'<sup>30</sup> Collings was also largely responsible for the interior design work that went into preparing Simpson for its grand opening.

Collings was completely mesmerized by the Simpson staff and mostly by Moholy-Nagy. She confessed that the work environment was 'absolutely stunning,' in that it allowed her to break free from the peripheral art education she had received in Australia. Further describing her experience at Simpson, she stated that 'the attitudes of Moholy and his team, their training, their knowledge, was so far away that it took [her] all day, every day, just to follow their thinking, let alone do the job [she] was expected to do. And yet they were easy to work with - they were wonderful teachers.' This intimate reflection reveals the constant challenge in working at Simpson, learning at Simpson, as well as producing at Simpson under the wing of one of the most established Bauhaus Masters. Moholy-Nagy, with his wealth of experience teaching a talented international audience of students at the Bauhaus wouldn't tell Dahl what to do, but rather, Dahl held the responsibility of telling him what could be done.<sup>31</sup>

It was the creative atmosphere at Simpson and the attention to every detail that proved instrumental in shaping Dahl Collings' relationship to colour. At the huge modern department store, for example, colour was used selectively and strategically. Colour was often used as contrast, with '...red on some floors, and as background to the sports clothes and equipment on the third floor, sky blue and emerald green.'<sup>32</sup> Additionally, the spirit of experimentation was an intricate component of modernity that Dahl Collings was able to gain while there. She was able to witness Moholy-Nagy's enthusiastic and fervent interest in experimentation, such as his innovative display of clothing on heat-formed body shapes made out of transparent plastic he himself formed.<sup>33</sup> Simpson provided a nurturing environment in which Dahl Collings gained confidence in her own experimentation, largely as a result of Moholy-Nagy's full support and devotion to instructing her. She shares that as she commenced experimenting without limit, she felt like she was capable of doing anything.<sup>34</sup> This self-expressed freedom can be seen in Dahl's engagement with all fields of art and design.

One of the most important facets that Moholy-Nagy and his team dealt with was managing the modern window display (Figs. 2 and 3), which refuted and transformed the century-old custom



Fig. 2. Simpson display window. Published in 'Display Lessons from a New Store,' in *Commerical Art/ Art and Industry*, July 1, 1936, 24, <http://magazines.iaddb.org/issue/CAI/1936-07-01/edition/null/page/24> (accessed January 15, 2016).



Fig. 3. Display stand for lounge suits found. Published in 'Display Lessons from a New Store,' in *Commerical Art/ Art and Industry*, July 1, 1936, 25, <http://magazines.iaddb.org/issue/CAI/1936-07-01/edition/null/page/25> (accessed January 15, 2016).

of no-show windows and display cases for men's stores in Britain.<sup>35</sup> Moholy-Nagy jumped at the opportunity of using window displays as a means to address the larger whole of society rather than just the usual museum or gallery visitor. The intricacy and complexity of elements surrounding window displays such as the versatility of a window that so easily was modified throughout the day depending on the time of day (morning, afternoon, and night) and other possible factors such as weather attracted Moholy-Nagy who enjoyed the aesthetic challenges intrinsic in this new medium. For Moholy-Nagy, what was being displayed was of no importance to him; he was preoccupied with the visualisation that was created by factors such as colour and arrangement and the emotional effect it would have on onlookers.<sup>36</sup> Moreover, Moholy-Nagy's work with Simpson window displays demonstrate his passionate Bauhaus sensibilities that he introduced to the English general public by applying his vision of colour and originality to the frequently visited streets and shop window displays in London. As Krisztina Passuth asserts: 'The shop windows of Simpson's took over the role of the earlier avant-garde exhibitions and theatres. The shop-windows dressed by the artist come alive, they are no longer mere shop- windows, but a late evocation of the Bauhaus spirit. Asymmetric advertising is like a mild electric shock to the eye.'<sup>37</sup> Moholy-Nagy explained, adding the finishing touches of his work directly before the opening of the department store. For a short time, the shop-window became a Bauhaus platform and absorbed the artist's attention entirely and exclusively.

<sup>30</sup> Ibid.

<sup>31</sup> "Making her Way in London," MAAS, Dahl and Geoffrey Collings Collection, 2007/30/1–14/1/2.

<sup>32</sup> Wainwright, *The British Tradition*, 28.

<sup>33</sup> Wainwright, *The British Tradition*.

<sup>34</sup> Caban, *A Fine Line*, 72.

<sup>35</sup> Sibyl Moholy-Nagy, *Moholy-Nagy: Experiment in Totality* (Cambridge, Mass.: M.I.T. Press, 1969), 119–120.

<sup>36</sup> Moholy-Nagy, *Moholy-Nagy*, 120.

<sup>37</sup> Krisztina Passuth, *Moholy-Nagy* (New York: Thames and Hudson, 1985), 65.

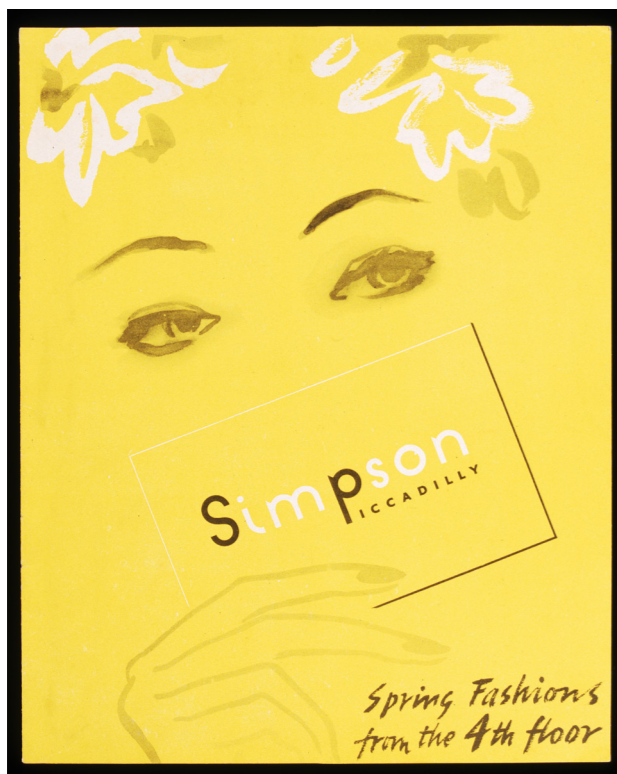

Fig. 4. Dahl Collings, Sydney/London/New York, 1930–60 Simpson Piccadilly, Spring Fashions catalogue cover designed by Dahl Collings. Courtesy of Museum of Applied Arts and Sciences, Sydney. 92/191-19.

female eyes seem to produce an effect in which they follow the viewer, and the simplicity in the use of facial features make the subdued female presence even more intriguing. The advertisement served to address the collection of female clothing that was later added to Simpson's fourth floor, breaking the strictly-male merchandise and masculine atmosphere that Simpson had once proudly boasted.

Because Dahl Collings reflections on her experiences at Simpson are so positive, it might be easy to overlook the challenges she overcame in securing a job that was staffed by men and catered to men. *The Manchester Guardian* explains Simpson's aim was to

...create an atmosphere where men shall feel at home, where they may buy not only their own shirts and socks, but purchase silk stockings for their womenfolk and presents for the family in a setting which is congenial and heartily male. Only the future can tell whether the attempt

Furthermore, at Simpson, a spirit of collaboration existed amongst the designers who cooperated on a variety of tasks. This is reflective of the Bauhaus principle of collectivity in production. According to Dahl Collings,

...you learnt to work with other people—if you didn't have the time or the experience, someone else would carry on from your idea and thus, as a unit, we were able to do everything. And the whole store was done in this way, with us working together as a unit. It was my first experience of that.<sup>38</sup>

Because of Collings' embracement of the teamwork environment that Simpson encompassed, however, it makes it difficult to find pieces that were accredited in Dahl Collings' name during her time at Simpson and later in her life once back in Australia. One work that has been attributed to Dahl Collings uses a bright yellow colour that is both pleasing to the eye with its happy tones of warmth (Fig. 4). The alluring fe-

will succeed, or whether women will invade this store in much the same way as they have monopolized all others.<sup>39</sup>

More than just overcoming the obstacles and impediments of working in a male-environment, Dahl Collings was able to thrive in the male-driven public sphere whose sole focus was men's fashion and accessories during the first year that she worked there. Furthermore, Simpson and the men Dahl Collings worked with while at Simpson can be interpreted as her modern network that provided her and her husband with encouragement and support with the common goal of disseminating the modern. By working with Moholy-Nagy, Breuer, and Kepes, she was also introduced to Walter Gropius and maintained contact with the four individuals after leaving London and returning to her home back in Australia. In the decades that followed, they were sending and receiving personal items such as a wedding invitation to Kepes' daughter's ceremony and more professional items such as brochures and catalogues demonstrating the work the Bauhauslers completed once stateside at their respective institutions. Among the letters exchanged between the Collings and the Bauhauslers, László Moholy-Nagy, while at the School of Design in Chicago in 1943, warmly congratulated the Collings on an exhibition, sent warm regards to the two Collings children, updated the couple with his then current project, and ended the letter with, 'please keep in contact with us at it is always a pleasure to hear from ones [sic.] friends.'<sup>40</sup> Even long after Moholy-Nagy's death the couple remained in contact with Lucia. Furthermore, the Collings' exchanged postcards with Moholy-Nagy, Kepes, and Breuer (Fig. 5).

It might come as no surprise from Dahl Collings' reflections on her experiences while at Simpson that she credits meeting and interacting with Moholy-Nagy as the greatest influence on her career.<sup>41</sup> The similar modernist-point-of-view from which both Collings and Moholy-Nagy departed meant that design was indivisible. For Moholy-Nagy, 'the problem posed by Simpson's window display



Fig. 5. Christmas card from Dahl and Geoffrey Collings to Marcel Breuer, 1938, in Marcel Breuer Papers, Special Collections Research Center. Courtesy of Syracuse University Libraries. 37854-002.

<sup>39</sup> Wainwright, *The British Tradition*, 32.

<sup>40</sup> László Moholy-Nagy, *Letter from Moholy-Nagy to the Collings, May 11, 1943*, MAAS, Dahl and Geoffrey Collings Collection, 2007/30/1–24/35.

<sup>41</sup> Caban, *A Fine Line*, 71.



Fig. 6. Dahl Collings, Fashion illustration. published in Richard Haughton James "Dahl and Geoffrey Collings," *Commercial Art/ Art and Industry*, August 1, 1938, 39. International Advertising & Design DataBase, <http://magazines.iadbb.org/issue/CAI/1938-08-01/edition/null/page/9> (accessed September 5, 2015).



Fig. 7. Dahl Collings, Design for a catalogue for the department store Harvey Nichols. Published in *Arts et Metiers Graphiques fr*, November 15, 1938, 13. International Advertising & Design DataBase, <http://magazines.iadbb.org/issue/AMG/1938-11-15/edition/null/page/81> (accessed September 5, 2015).

was basically no different from a setting for *Madame Butterfly*.<sup>42</sup> Likewise for Dahl Collings, whose lack of interest in narrow specialization led to her seeing 'no difference between planning a poster, an electric iron, and exhibition stand or the scenario for a documentary film'.<sup>43</sup> In other words, both Collings and Moholy-Nagy had the sensibility to join all arts and crafts for the common goal of creating something visually striking, a core principle clearly expressed in the Bauhaus manifesto.

<sup>42</sup> Moholy-Nagy, *Moholy-Nagy*, 125.

<sup>43</sup> Richard Haughton James, in "Exhibition of Modern Industrial Art and Documentary Photos at the David Jones Gallery," (1939), 3, Museum of Applied Arts and Sciences (MAAS), Dahl and Geoffrey Collings Collection 92/191-22-7.

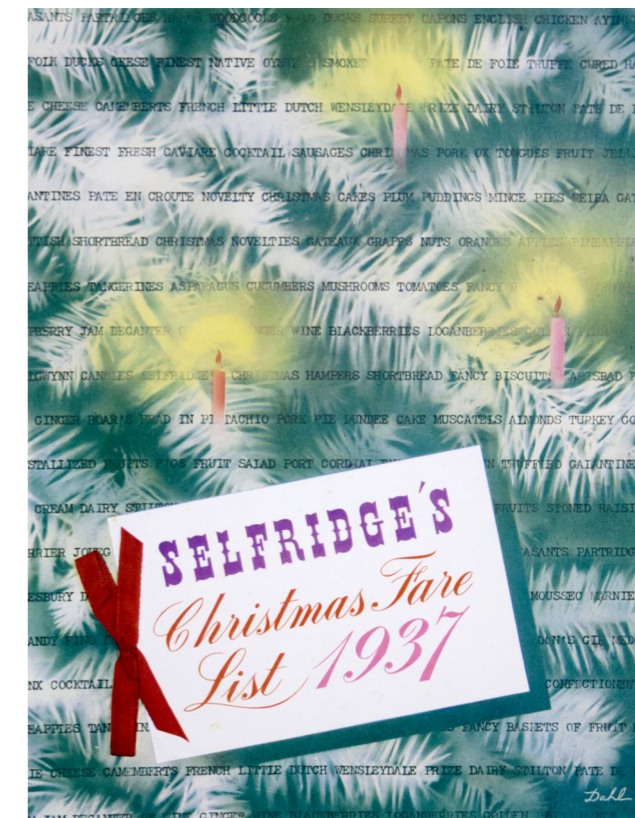

Fig. 8. Dahl Collings, Advertisement, artwork: Selfridge's Christmas Fare list 1937. Courtesy of Museum of Applied Arts and Sciences, Sydney. 92/191-2/9.

### Dahl Collings - Modernist Artist

Utilizing the skills learned at Simpson, Dahl Collings went on to produce catalogue work for several British brands (Fig. 6) and for British department stores, Harvey Nichols (Fig. 7) and Selfridge (Fig. 8). Collings' work for these department stores is exemplary of the simplistic yet effective advertising skills Collings mastered while at Simpson with delicate and sweeping lines that characterize her work. The work for department store, Harvey Nichols consists of natural elements such as a rope strand, minimalistic clouds, and centrally-positioned plant individually provide lively touches while at the same time, working together to form a discrete face; the strand acting as the enclosing head, the clouds as eyes, and the plant as nose and lips. The dual nature of all of these forms further strengthen Dahl's whimsical touch to the work. Similarly, Collings' work for Selfridge's Christmas Fare List, whose bold green background shows illuminated Christmas tree branches, appears as a direct influence of Moholy-Nagy's experimentation with photograms, a technique that Collings would later exhibit in Australia as 'photographs without a camera'.<sup>44</sup>

<sup>44</sup> Dahl and Geoffrey Collings "Modern Industrial Art and Documentary Photos," 1939, exhibition catalogue, MAAS, Dahl and Geoffrey Collings Collection 92/191-22-7.

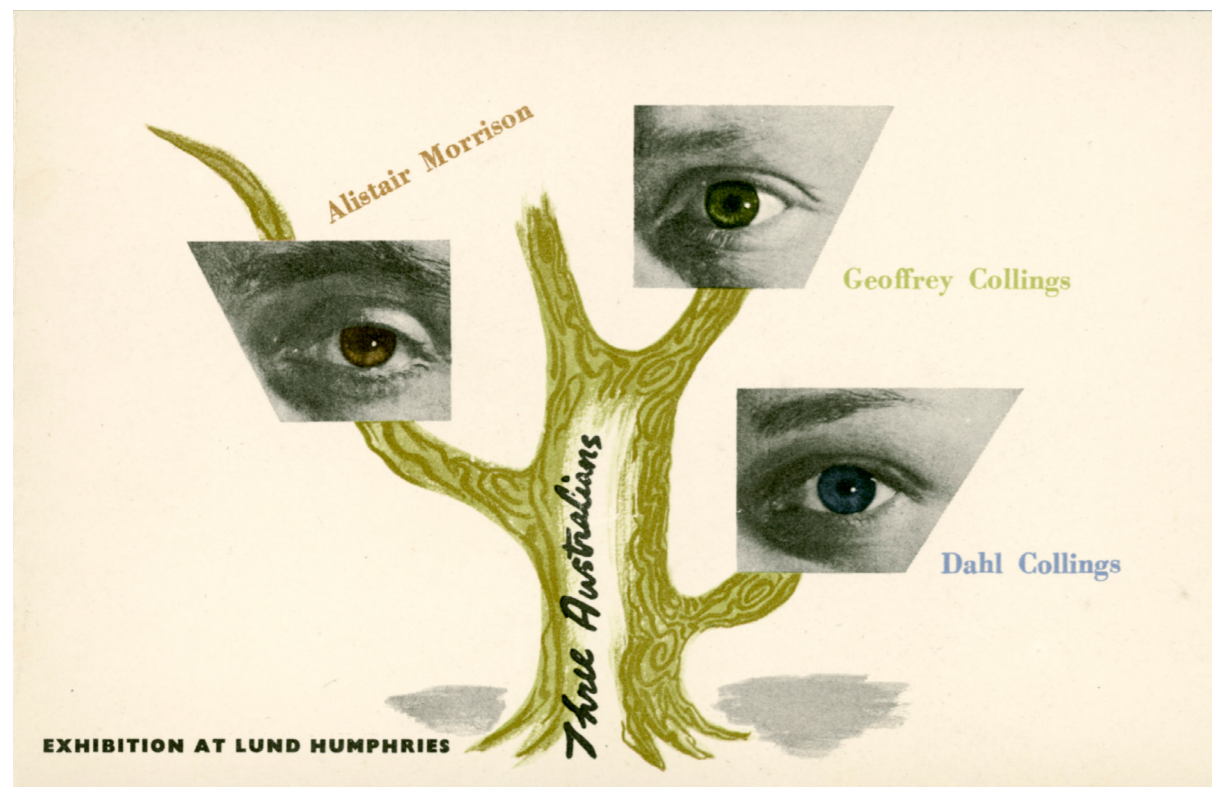

Fig. 9. Dahl and Geoffrey Collings and Alistair Morrison, Invitation, to exhibition "Three Australians", commercial art and photography, at Lund Humphries Gallery, London, 1938.  
Courtesy of Museum of Applied Arts and Sciences, Sydney. 92/191/22-1.

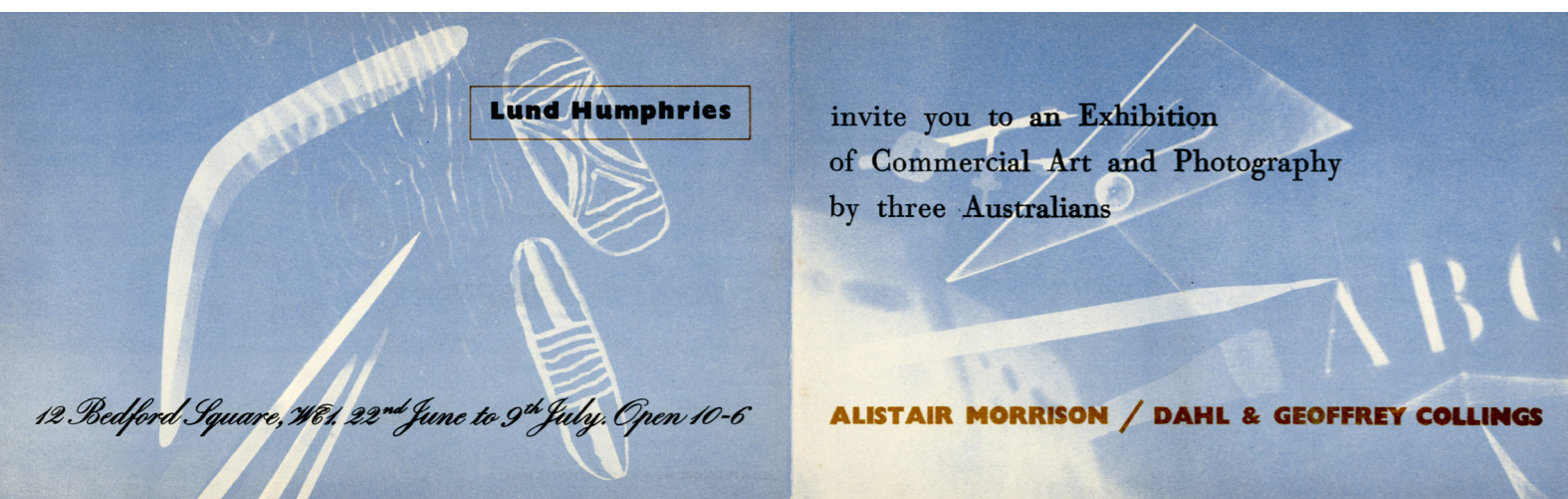

Fig. 10. Dahl and Geoffrey Collings and Alistair Morrison, Invitation, to exhibition "Three Australians", commercial art and photography, at Lund Humphries Gallery, London, 1938.  
Courtesy of Museum of Applied Arts and Sciences, Sydney. 92/191/22-1.

Before leaving London, Dahl Collings, Geoffrey Collings, and Alistair Morrison held the "Three Australians" exhibition consisting of commercial art and photography at the Lund Humphries gallery in London (Figs. 9 and 10). One variation for the invitation for the Lund Humphries Gallery (Fig. 10), demonstrates yet again the Collings' experimentation with photograms – a photographic technique Moholy-Nagy is extensively known for – while the other variant (Fig. 9) perhaps served as inspiration for Kepes' *Advance Guard of Advertising Artists* which he would produce a couple of years later in 1942.

On the brochure of the exhibition, established English poster artist, E. McKnight Kauffer, famous for his London Underground posters, wrote on the brochure for the exhibition:

We must get rid of the idea from our minds that Australia only stands for Sheep Farming, the Life of the Open Air, and Sports- especially cricket. Slowly and surely there are influences at work introducing other aspects of what might be called a more intellectual life. These Three Australian Artists are symptomatic of this gradual change: their approach to designing and photography is the same as in this country but it has the added attraction of simple directness, which seems to come from their affinity with the open air life of their own country. Their work is so interesting I am glad it is to be shown to the English public. I believe it is the first occasion upon which an exhibition of this kind has been devoted entirely to Australians.<sup>45</sup>

Thus, Dahl Collings, along with her husband and Alistair Morrison, were able to leave London while at the same time leaving a part of themselves, their legacy, back in London. As promoters of not just modern art, but of a refined Australian aesthetic and elevation of artistic standards, the trio was not just able to benefit from Britain, but most significantly, add to it.

Dahl Collings can be viewed as a powerful icon of modernity and as a 'woman of the world'<sup>46</sup> through her cosmopolitan nature and travels to countries such as Tahiti, Spain, and America. As seen in an intimate capture by Geoffrey Collings (Fig. 1), Dahl stands assertively looking forward with a camera, a mechanical symbol of modernity, as if it were a natural extension of her physical human body. This photograph demonstrates a woman who is strong, fashionable, ambitious, and passionate - the very definition of who Dahl Collings is.

Dahl's pivotal engagement with the public sphere through her various active artistic roles in the 1930s, as well as the additional roles of both a mother and a wife during a time when a woman's traditional association with the fine arts kept her within the private sphere,<sup>47</sup> certainly demands recognition. Dahl Collings went against and denounced the mutually exclusive option of either having a marriage or a career. She had a marriage, two children, career aspirations, as well as a balanced partnership with her husband Geoffrey Collings. According to British modernist

45 Caban, *A Fine Line*, 73.

46 Woollacott, *To Try Her Fortune*, 23.

47 Brian Head, *Intellectual Movements and Australian Society* (Melbourne: Oxford University Press, 1988), 146.

Richard Haughton James, with whom the Collings worked, Dahl and Geoffrey exemplify a model partnership of collaboration and support. The following is an excerpt by Haughton James:

As much as can be learned from the rough and tumble of technical training in art schools and studios, engraving plants and advertising agencies, big retail stores and display firms, they have between them. As much as can be learned by study, travel, and wide circle of contacts, they have too. They have made illustrations, posters and folders, designed window displays and made photographs without number for concerns whose name is legion. They have worked under the competitive stimulus of some of the best designers in Europe, and have ploughed lonely furrows in the hard, resisting clay of business depression. They have worked with the founders of the documentary film movement in London and made films themselves in Spain and Tahiti; they have had their work published as examples by 'Photographic' and 'Arts et Métiers Graphiques' in Paris, had their own public exhibition early this year in London, shown in Rotterdam in 1937, been written-up and reviewed in many publications... As plain producers of 'useful art' these people are the designers of our world.<sup>48</sup>

Thus while Dahl and Geoffrey's marriage was a rare one, it certainly was a modern one in which marriage and artistic collaboration meant equal support for each other's artistic and intellectual endeavours so much so that they often co-signed works together, making it often impossible to accredit just one of them with a specific work. Geoffrey Collings and Dahl Collings were partners in both of the possible definitions a partnership can represent; one tied to professional teamwork, and simultaneously, one tied to the marital relationship.



Fig. 11. Dahl and Geoffrey Collings, Invitation, to exhibition of industrial art and documentary photos, at the David Jones Gallery, 1939. Courtesy of Museum of Applied Arts and Sciences, Sydney. 92/191-22/4.

It was not a direct flight back to Australia as the Collings made a few stops in Tahiti and Spain to pursue further artistic endeavours. Nonetheless, upon their return back to Sydney in 1939, along with British artist Richard Haughton James who had also worked in London and had succeeded Geoffrey Collings as art director of Erwin Wasey, the trio turned their attention to creating something that would complement their shared interest in industrial design by evoking the Bauhaus spirit of collaboration. The Design Centre was born in an attempt to introduce better industrial design standards in Australia. While at the Design Centre, the trio completed 'design models for

industry and provided art direction, graphics and exhibition work' while at the same time, collaborating with other Australian artists.<sup>49</sup> The two would go on to produce exhibitions for the 1939 Australia World Fair in New York and producing the Exhibition of Modern industrial Art and Documentary Photography at the David Jones' Gallery (Fig. 12), 'considered as one of the first of its kind in Sydney',<sup>50</sup> just within a few short years since their time in London. With decades of artistic ventures ensuing well until the 1960's, Dahl and Geoffrey continued developing and applying a modern eye that they adopted from the Bauhaus masters in London.

In conclusion, Dahl Collings was an artist who did not allow circumstances during her time to keep her from engaging in the arts from the late 1920s onwards. She had to pursue her career through Australia's hesitance against modernism, the world wars and the many ensuing conflicts, as well as through the Depression. This posed the greatest challenge for her as a woman artist because of the resistance to women assuming positions that were intended to be filled by male counterparts<sup>51</sup> and the general belief that women should instead take on the role of 'home-maker' as a solution to the aftermath of the Depression. In every way modern, Dahl Collings rose above these challenges and throughout her life continued to exemplify the Modernity she had brought back to Australian soil in her suitcase contributing to Australian cultural and artistic production.



Fig. 12. Dahl Collings, gouache on paper. Sydney, New South Wales, Australia, / New York, USA, 1950-53. Courtesy of Museum of Applied Arts and Sciences, Sydney. 92/191-16/5.

<sup>49</sup> Caban, *A Fine Line*, 77.

<sup>50</sup> Bogle, *Design in Australia*, 113.

<sup>51</sup> Topliss, *Modernism and Feminism*, 38.

<sup>48</sup> *Modern Industrial Art and Documentary Photos*, 1939, exhibition catalogue, MAAS, Dahl and Geoffrey Collings Collection 92/191-22-7.

**Veronica Bremer**  
Jacobs University Bremen



Veronica Bremer is a Ph.D. candidate in the Art History and Theory Program at Jacobs University Bremen under the supervision of Prof. Dr. Isabel Wünsche. She is involved with the DAAD-ATN Exchange Program between Germany and Australia whose primary focus is on the reception of German Modernism and the Bauhaus in Australian art, architecture, and art education between 1920 and 1960.

E-mail: [v.bremer@jacobs-university.de](mailto:v.bremer@jacobs-university.de)



## ‘Creating Order amid Chaos’: Architect Lotte Beese in the Soviet Union, 1932–1935

Lotte Beese (Reisicht, Silesia 1903 - Krimpen aan den IJssel, the Netherlands 1988) cooperated for some years as an architect in building the *Sotsgorods* (socialist cities) in the Soviet Union. In interviews in the seventies and eighties, she looked back on her work and the living conditions in this country. These memories are being examined against the results of research carried out in archives and by means of literature studyreview. Consideration will be given to where she worked, with whom, and which designs she made.

This paper discusses whether there are similarities between her working experiences and the conclusions drawn by architectural historians on the work of western architects involved in the Soviet Union. How can these personal memories be evaluated within the perspective of a later approach to this issue by architectural historians?

From the seventies, architectural historians have written critically about the participation of western architects in the urban development of the communist state. In their research, these authors focus mainly on the Russian growing suppressive and hostile attitude towards the architects by the Russian authorities. Beese’s ego documents will be compared with the views of these historians.

Keywords: ego documents, history of architecture, socialist cities, city planning

You could say we were composing something – which starts with where you place your buildings. For instance, as in Orsk, you can choose whether to build the district up against the hillside, or on top of the hill. We certainly didn’t know everything; but there was something we all had inside us. Creating order amid chaos – that was the reason we were there, and what we were all trying to do.<sup>1</sup>

These words by Rotterdam’s then retired urban planner and architect Lotte Stam-Beese (1903–1988)<sup>2</sup> tell us something about her experience of working as a foreign architect in the Soviet Union during the 1930s.

This paper takes her recollections of that period, recorded in interviews from the 1970s and 1980s, as the starting point for a number of questions. What work was she doing there, and in what context? Do later conclusions by architectural historians about the work of western architects in the Soviet Union tally with what she claimed to have seen and felt while she was there? And how are her recollections to be assessed in the light of all this?

### The Lure of the *Sotsgorods*

Lotte Beese was one of more than 20,000 architects, urban planners and engineers who travelled from Europe and America to the Soviet Union in the 1920s and 1930s to help build up the country.<sup>3</sup> The engineers worked in the rapidly expanding Soviet industry, and the architects and urban planners

- 1 Interview by Cor de Wit with Lotte Stam-Beese (Krimpen aan den IJssel, January 15, 1977), Het Nieuwe Instituut (HNI) archives, Rotterdam, WITC CD-R 5. The interview quotations are translated from the original Dutch.
- 2 After her marriage to Mart Stam in 1935, Lotte Beese was officially known as Lotte Stam-Beese (in the Netherlands, married women often retain their maiden names in this hyphenated form). She kept the full name after her divorce in 1943. For simplicity’s sake, the name ‘Stam’ will be omitted in the remainder of this paper.
- 3 Michael David-Fox, *Showcasing the Great Experiment: Cultural Diplomacy and Western Visitors to the Soviet Union 1921–1941* (Oxford: Oxford University Press, 2012), 184.

mainly developed plans for the construction of *sotsgorods*, the 'socialist cities' built near projected new industrial areas. The number of architects and urban planners grew swiftly during the period of the First Five-Year Plan initiated by Stalin (1928–33), but then drastically declined. The great majority of them left the country – sometimes, but not always, of their own volition.

The involvement of these professionals was not an isolated phenomenon. A like-minded group were the 'fellow travellers': writers, artists and scientists who sympathised with the ideology of 'the red utopia' and went to the Soviet Union for a temporary stay or an incidental visit. This 'travellers' hype' continued up to the mid-1930s, and attracted about 80,000 enthusiasts.<sup>4</sup>

A key stimulus to work in or visit the Soviet Union was cultural exchange between countries through exhibitions and distribution of art magazines and technical journals.<sup>5</sup>

Going to the Soviet Union, of course, had a far greater impact on the lives of these early labour migrants than on those of their fellow travellers – for the former were leaving their homes and families to settle and work in a foreign country for long periods of time.

Most of the architects came from Germany. Important contacts had developed between the Weimar Republic (1918–33) and the Soviet Union, and Germany now had experience with the construction of modern housing districts (*Siedlungen*) in long slabs. Russia lacked such expertise in the field of modernist architecture, and was keen to take advantage of it.

Lotte Beese was also German (Fig. 1). She was trained at the Bauhaus in Dessau, where she was the first female student to take the *neue Baulehre* ('new theory of building') architectural course. She had an affair with the initiator of the course, the Swiss architect Hannes Meyer, who was also director of the Bauhaus, and because of this, she was forced to break off her training. She then worked for architectural firms in Berlin and Brno. In spring 1932 –when she was by then the mother of Meyer's

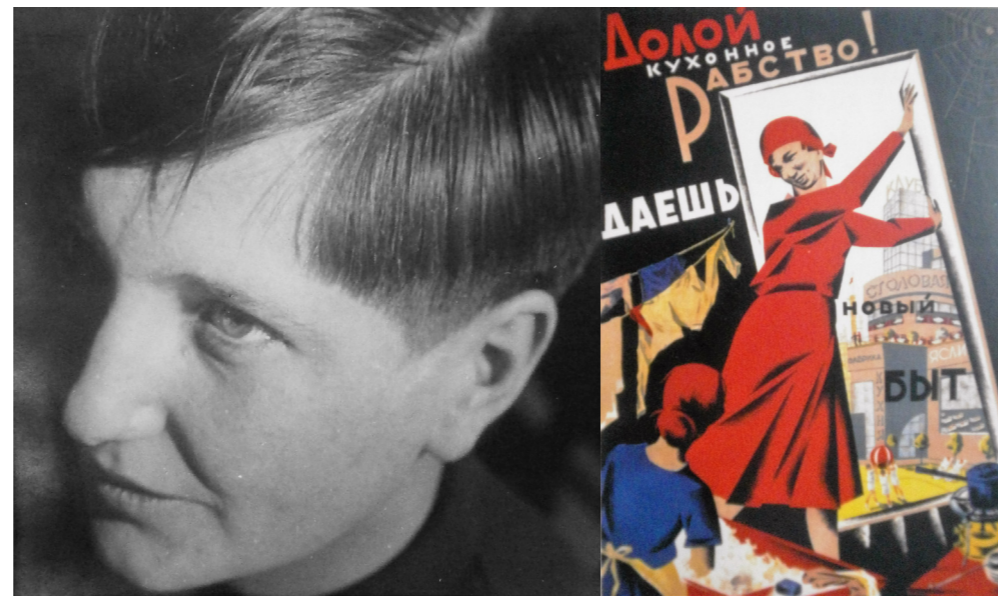

Fig 1. Lotte Beese, photographer unknown, c. 1928. Courtesy of A.R. Stam.

Fig. 2. G. Shegal, Poster *Down with kitchen slavery. A new life*, 1931.

Source: [www.plakat.ru](http://www.plakat.ru).

son – she left Brno for Kharkov<sup>6</sup> in Ukraine. She did this entirely on her own, without a partner and not as part of a team – a bold undertaking for a woman in those days.

There were economic, political and cultural reasons to go and work in the Soviet state and Lotte Beese had all three. She could no longer find work in Czechoslovakia, not only because jobs were in short supply but also because she was an unmarried mother. In the Soviet Union, on the other hand, there was plenty of work for architects, and women were greatly encouraged to work outside the home (Fig. 2). Beese was an active member of the pro-Soviet

Czechoslovakian communist party, and after several arrests because of her political activities it was no longer safe for her to remain in the country. There was also a cultural affinity. At the Bauhaus, where her teachers had included Wassily Kandinsky, and in Brno, where she attended meetings of the *Levá fronta* (Left Front) cultural association, she became fascinated by the work of progressive Russian artists and architects. In short, helping to build the *sotsgorods* was a very attractive prospect.

### Recollections of Moscow, Kharkov, Orsk and Lake Balkhash

In 1976, 1977 and 1986, from eight to 18 years after she retired, Lotte Beese was interviewed at length by two former architects whom she knew well, on their initiative.<sup>7</sup> The interviews revealed that her recollections of the Soviet Union were very much associated with places, friends and key events. In 1930, having been dismissed from the Bauhaus, her first love Hannes Meyer left for Moscow to become a professor at the State College of Building and Architecture and chief architect at the Institute for the Construction of Higher and Technical Schools. He asked her to move in with him and work for him. Although she said yes, they stayed together for only a few months. Out of solidarity with the Russian workers, Hannes refused to accept the food coupons that were issued to foreign employees. Lotte disagreed, and soon left him. Just over a year after this brief stay in Moscow, she set off for Kharkov. She never explained exactly how this was arranged, but she did

<sup>4</sup> David-Fox, *Showcasing*, 184.

<sup>5</sup> The first exhibition of Russian art in Western Europe was organised at the Van Diemen gallery in Berlin by the artist El Lissitzky in October 1922. Twenty exhibitions of work by famous western architects, including Walter Gropius, Mies van der Rohe, Erich Mendelsohn, Max and Bruno Taut, Ludwig Hilberseimer and Hugo Häring, were held in Moscow in the early 1920s. Among the western journals distributed in Russia were Germany's *Städtebau* and *Der Industriebau*, Britain's *Architectural Review* and *The Architect*, France's *La Construction moderne* and the USA's *American Architect* and *Architectural Forum*.

<sup>6</sup> This city is now known in English by its Ukrainian name Kharkiv, but in the days before Ukrainian independence its Russian name Kharkov (sometimes transliterated as Charkov) was more common. For ease of reference in historical contexts, the Russian place names will be used throughout this paper.

<sup>7</sup> Lotte Beese was interviewed by Cor de Wit and Arno Nicolai. De Wit produced a publication based on these interviews, see note 8.

mention that she left her little son, Peter, with a married couple in Prague for six months. As soon as circumstances permitted, she took him back with her to Kharkov, where a homeless girl called Manya looked after him.

Lotte Beese said she was shocked by the state of the city. The forced collectivisation of agriculture had caused a terrible famine. Resistance by farmers had led to large areas of land remaining uncultivated, and millions of people in Ukraine starved to death. She saw people dying in the street and the corpses being collected in the evening by the health services. An ensuing typhus epidemic had an immediate impact on her working conditions: 'Our trust included some 160 architects, but by the spring there were only 30 left – the rest had died of typhus.'<sup>8</sup>

She did not say much about her work in Kharkov. It seems she mainly drew up standards for future housing for, among others, the many homeless people. This involved making calculations and standard ground plans for the requisite amount of living space, play areas and so on.

Besides the shocking confrontation with the fate of the local population, something good also happened to her. She ran into her former Bauhaus teacher the Dutch designer and architect Mart Stam, who was also working in the Soviet Union. Lotte and Mart, whose marriage had broken down, fell in love and decided to spend their lives together. She felt it was very important for male foreign architects to live with a woman.

Even though you were working with Russian and non-Russian colleagues, you were still living in an alien environment. The great majority of the foreigners were men. The married men often had their wives and even children with them. But if you didn't have a wife and children, things were difficult. Some men started drinking, and some simply disappeared. So a man couldn't just remain alone. He had to have someone with him.<sup>9</sup>

We would now see this as a confirmation of traditional gender roles. At the same time, it makes clear why she wanted to live with Stam. The need to find a new father for her young son must also have been a factor.

They worked together on the redevelopment of Orskaya in the southern Urals into the industrial *sotsgorod* Orsk. She was supposedly involved in discussions there about the construction of the *sotsgorod*, making drawings and designing children's homes for the city.

She was more candid in her interviews about a project that was never carried out and would lead to the couple quitting the Soviet Union permanently. Their assignment was to build a town on Lake Balkhash, in what is now Kazakhstan. They both found their journey there a memorable experience,

flying in a small plane from Orsk to Alma-Ata and from there across the desert, with Lake Balkhash spread out beneath them.

We could see a toxic-looking expanse of water whose blue-green colour turned out to be due to copper mining ... We landed in an area with no trace of life, no flora or fauna of any kind. We were overwhelmed by the utter silence – an almost unimaginable silence ... Not the slightest sound. Since the soil was thoroughly polluted by salt and copper, animals and plants couldn't live there – and nor, in fact, could people.<sup>10</sup>

They discovered that thousands of prisoners and forced labourers had been brought to the inhospitable area to mine copper. Back in Moscow they reported that it was impossible to build a town in such a polluted region; it would be better to build new housing in the nearby city of Alma-Ata and create encampments in the new town where rotating teams from Alma-Ata could come and work for a month at a time. But their proposal was not accepted, and furthermore was seen as refusal to work. It was a frightening moment for them both: 'The fellow could have put us straight up against a wall, for in the Soviet Union refusing work was the ultimate crime'. Stam, who had taken on the assignment, felt he had no option but to leave the country. But Beese had her doubts:

At first I hesitated. Should I stay there, or go with him? I hated the idea of leaving Russia. If we hadn't left, what would have happened? And God help us if Hitler had got his hands on this country. At the time I had more faith in the Russians and in politics than Stam did. He wanted to take me to Holland, but I didn't like the idea at all. It was all very difficult for me.<sup>11</sup>

The fact that Ukraine and Byelorussia (now Belarus) would in fact be occupied by the Nazis is not mentioned in the interview.

### From Recollection to Reality

What can we find in the literature and archives that confirms – or conflicts with – Lotte Beese's personal recollections as recorded in her interviews? What we do know about her brief period of work in Moscow in autumn 1930, when she was living with Hannes Meyer, is that initially he was working there with seven former Bauhaus architecture students, all of them men, who had followed him to Moscow. Meyer had formed them into the Red Front Brigade which was working to build up the Soviet state in accordance with 'Marxist philosophical' principles. At first the team worked on the construction of technical schools and later the *sotsgorods*. Lotte Beese must have been involved in the initial project.

8 Cor de Wit, *Lotte Stam-Beese (1903–1988), "Je moest kiezen, zwart of wit...": Op weg naar helderheid, Ontmoetingen en herinneringen van een architect* (Apeldoorn, self-published publication, 2005), 42.

9 Interview by Cor de Wit with Lotte Stam-Beese, (Krimpen aan den IJssel, February 15, 1976), HNI archives, Rotterdam, WITC CD-R 4.

10 De Wit, *Lotte Stam-Beese*, 44.

11 See note 9.



Fig. 3. Drawing for KhtZ signed by Lotte Beese, 1932. Courtesy of Het Nieuwe Instituut, Rotterdam, STAB ph174.

The archives shed new light on her work in Kharkov from spring 1932 to autumn 1933. Some photographs of drawings of Russian housing districts (*kvartals*) bearing her signature have survived in her personal files at Het Nieuwe Instituut in Rotterdam. They are made for Giprograd, the Ukrainian section of the State Institute of Town Planning. Research in Kyiv and Kharkov shows that the drawings resemble designs for *sotsgorod* KhtZ, a large, linear district on a railway line ten kilometres from the city centre of Kharkov. It was built from the end of the 1920s and was officially intended for employees of the newly-built nearby Kharkov Tractor Factory. The factory was funded with capital provided by the American industrialist Henry Ford and designed by the architect Albert Kahn. Kahn was the leading American architect working in the Soviet Union, where he and his staff had built over 500 factories.<sup>12</sup> In the years when Beese was living in Kharkov, the *sotsgorod* was the biggest construction project in the city, supervised by the Ukrainian architect and urban planner P. F. Alyoshin. The forecast number of people that would come to live in the *sotsgorod* was 36,000. The files that Alyoshin left after his death indicate that old-age pensioners, young graduates and unemployed people would also be housed there.<sup>13</sup> This accounts for Beese's recollection that many people, including homeless people, were to be accommodated in the new dwellings.

In each *kvartal* her designs placed the central kitchen and collective dining room on the south side, and in the middle were parallel rows of four-storey blocks of flats interspersed with crèches, schools and green areas (Fig. 3). Socialist ideas about the importance of women working outside

12 See Anatole Kopp, "Foreign architects in the Soviet Union during the first two Five-Year Plans," in William C. Brumfield (ed.), *Reshaping Russian architecture* (Cambridge: Cambridge University Press, 1990), 176–214.

13 Christina E. Crawford, "The long-term effects of settlement isolationism: Armenikend/Baku, KhtZ/Kharkiv, Sotsgorod/Magnitogorsk" (paper presented at the Ekaterinburg Academy of Contemporary Art, Ekaterinburg, Russia, May 2014), 3. P. F. Alyoshin's archives can be found in the Central State Archives Museum of Literature and Arts of Ukraine in Kyiv. Drawings of KhtZ in the Zabolotnov State Science Library of Architecture and Constructions in Kyiv.



Fig. 4. Dwellings KhtZ, Kharkov, 2015. Photo by Hanneke Oosterhof.

the home were enshrined in the *sotsgorods*, including this one. The flats had no kitchens, and children were placed in crèches with permanent sleeping areas so that their mothers did not have to look after them.

As of 2015, two *kvartals* in the now dilapidated KhtZ district are still inhabited or otherwise in use (Fig. 4).

For her work from autumn 1933 onwards, Beese had to move to Moscow with Peter and Manya. It was from here that the work she did with Stam for the *sotsgorod* Orsk (where they also stayed from time to time) was organised. The project was carried out with members of the May Brigade. Comprising some 40 architects and headed by the famous and politically uncommitted Frankfurt architect Ernst May, this brigade had been

invited to the Soviet Union by the Russian authorities in 1930. Stam, who had worked on the Hellerhof *Siedlung* in Frankfurt, was also a member of the group. In late 1933 the Russians stopped working with May, who then had to leave the country because of an internal power struggle in the Soviet leadership, in which the NKVD (People's Commissariat for Internal Affairs) had seized full control and no longer wanted foreigners in positions of authority.<sup>14</sup> The brigade became part of the new Standartgorproekt state trust, in which some 150 foreign professionals now worked.

While living in Amsterdam in 1935, Beese edited an article on crèches and children's homes in the Soviet Union for the architects' association journal *De 8 en Opbouw*.<sup>15</sup> She included sketches of two pavilion-style children's homes designed for Orsk; she may have been the designer, but this was not specified. Curiously, she wrote nothing about her personal experiences in Orsk. The May Brigade is known to have produced designs for one *kvartal* in this *sotsgorod*. The fact that Lotte Beese was involved in designs for flats is apparent from notes by the architect and former Bauhaus student Philipp Tolziner, who stated that the staircases she had designed for the flats had to be altered because they did not fit.<sup>16</sup> Beese's archives contain some photographs of designs for flats in Orsk that she may have helped produce. There is also a photograph of a ground plan for a school with 640 pupils (Fig. 5). This design, which in all likelihood was hers, was eventually built in the *sotsgorod* in an adapted form.<sup>17</sup>

14 See Thomas Flierl, "Vielleicht die grösste Aufgabe, die je einem Architekten gestellt wurde," in Claudia Quiring et al., *Ernst May 1886–1940* (Munich: Prestel, 2011), 157–95.

15 Lotte Beese (ed.), "Over bewaarplaatsen en kindertehuizen in U.S.S.R.," *De 8 en Opbouw* 6 (1935), 7–23.

16 Note by Philipp Tolziner, Mapped Tolziner 58, Bauhaus-Archiv Berlin.

17 Written communication to the author by Astrid Volpert (Berlin, August 19, 2015).

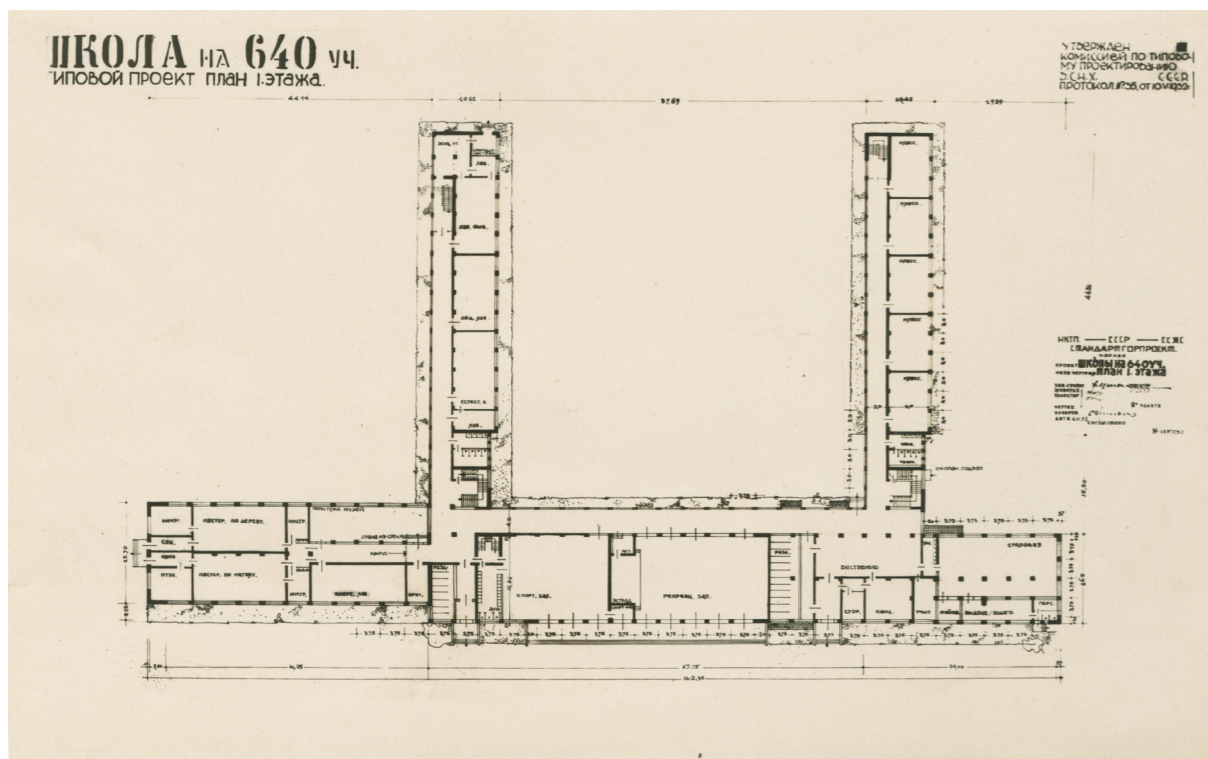

Fig. 5. Ground plan for a school in Orsk, 1933. Attributed to Lotte Beese. Courtesy of Het Nieuwe Instituut, Rotterdam, STAB ph126.

Another female foreign architect who worked in the Soviet Union was Austrian, Grete Schütte-Lihotzky. She was the only female architect to join the May Brigade, together with her husband the architect Wilhelm Schütte. She had first made a name for herself with her rationally designed 'Frankfurt kitchen', but she now also had experience as an urban architect. Her job in the Soviet Union was to design crèches and nursery schools. Among the places she worked on was the *sotsgorod* Magnitogorsk in Siberia.<sup>18</sup> She must have met Lotte Beese when Lotte started working with architects from her brigade; but neither of them made any mention of the other in their correspondence, personal notes or interviews.

As far as we know today, Beese and Schütte-Lihotzky were the only female foreign architects working in the USSR at the time.

Beese's recollections of the assignment for the town on Lake Balkhash cannot be verified from archival material, but they do appear in publications about both her and Stam. The independent

accounts of the pair tally.<sup>19</sup> The *sotsgorod* Balkhash was eventually built in 1937, after almost all the foreign specialists had left the country. The project was carried out by the Russian construction company Pribalkhashstroy in partnership with the copper factory BGMC.<sup>20</sup>

### Utopian or Idealist?

When reviewing western architects' help in building up the Soviet Union, architectural historians refer to these pioneers as utopians.<sup>21</sup> They wanted their architecture to create a new reality; but this goal remained utopian, for their avant-garde architecture could not be built according to plan, among other things because of lack of proper materials and – a more fundamental consideration – the Russian authorities' subsequent switch to a neo-classicist style, also known as socialist realism.

The use of the terms 'utopia' and 'utopians' recalls the imagery used by Russian thinkers and writers when talking about the realisation of a 'communist utopia'. The terms thus seem to reflect a single notion – but there is a clear difference. The western architects were unwilling or unable to create a utopia. Their 'utopia' was to build a better – in this case, socialist – society through their work and its products.

There was a good deal of philosophising about a Russian utopia well before the revolution, particularly in popular books. The favourite volume in the genre was *Красная Звезда* (Red Star), published in 1908 by the Bolshevik physician and science-fiction writer Aleksandr Bogdanov (Fig. 6). The book is about a Russian scientist who travels to Mars to study the socialist system there. On returning to Earth he tells of what he has learned. The constructivist architecture that flourished in Russia in the 1920s



Fig. 6. Cover *Red Star* by Aleksandr Bogdanov, 1908.

<sup>19</sup> See, for instance, Simone Rümmele, *Mart Stam* (Zurich: Verlag für Architektur, 1991), 111; Jeroen Schilt and Herman Selier, "Van de oevers van de Oder tot Krimpen aan den IJssel," in Hélène Damen and Anne-Mie Devolder (eds.), *Lotte Stam-Beese 1903–1988* (Rotterdam: De Hef, 1993), 18–19.

<sup>20</sup> See "Balkhashtvetmet," <https://en.wikipedia.org/wiki/Balkhashtvetmet> (accessed August 3, 2015).

<sup>21</sup> See, for instance, Manfredo Tafuri and Francesco Dal Co, *Architektur der Gegenwart* (Stuttgart: Belsler Verlag; Milan: Electa Editrice, 1977), 214–220; Kopp, "Foreign architects," 210.

<sup>18</sup> See Peter Noever (ed.), *Margarete Schütte-Lihotzky, Soziale Architektur: Zeitzeugin eines Jahrhunderts* (Vienna: MAK, 1993).

was prophetically propagated here.<sup>22</sup> An explosive outpouring of utopian books and experimental designs was to follow in the course of the century.

Personal notes, interviews and memoirs by foreign architects who worked in the Soviet Union make clear that the term 'utopia' was not part of their vocabulary – they were far too practically-minded for that. An exception was Hannes Meyer, who did use the term, only to dismiss it as 'bourgeois'. He spoke instead of 'Leninist architecture', which would serve as a weapon in the class struggle – aesthetics was not a factor here.<sup>23</sup> To the best of my knowledge, Lotte Beese did not use the term 'Leninist architecture', nor did she call herself a utopian. Had you asked her if she had been a utopian living in the Netherlands, looking back on her time in the Soviet Union with some detachment, and aware that 'utopian architecture' was a much-used post-war term she would have said no. Her pragmatic attitude was not compatible with belief in utopias, or thinking in terms of them. Like many of her fellow architects she considered herself an idealist, although she did have her reservations.

I wasn't a thoroughgoing idealist. Of course, I did have my ideals; but I was also a realist and a materialist, in the good sense ... I went to Russia out of conviction, a basic belief in socialism, if you like. But I did realise things wouldn't always go the way you'd expected ... Many people, myself included, did look forward to a better society.

She was also aware of the potential friction here.

The funny thing is that the Russian authorities were none too keen on idealists. They preferred people who were down to earth. They had no problems with people who'd gone there with down-to-earth motives – they were there to work, and that was that!<sup>24</sup>

### 'Inhuman Cities'

In the years when Beese lived and worked in the Soviet Union, there was a shift in ideas about what architecture should mean. The 1932 worldwide design competition for the Palace of the Soviets, with proposals submitted by such figures as Le Corbusier, Walter Gropius and Auguste Perret, as well as the less famous Dutch architect Han van Loghem, is generally seen as a major turning point in Russian architecture. The avant-garde architects' designs were rejected in favour of one submitted by the Russian Boris Iofan – a megalomaniac neo-classicist palace. Buildings – including to some extent those in the *sotsgorods* would henceforth have to have historical, classical features.



Fig. 7. Dwellings *sotsgorod* Magnitogorsk with at the left crèche designed by Grete Schütte-Lihotzky, 1932-35. Courtesy of Canadian Centre for Architecture, Montréal.

Beese had her own direct experience of this change while living in Moscow.

Kaganovich, the then Minister of Construction, gave a speech in which he said: 'We're on the way to prosperity, and we have to show it.' And what happened? It seems hard to believe nowadays, but they actually did it. We were living in a five-storey building. They stuck columns in front of it, one of which obscured about a third of our window, and they put a cornice and a tympanum on the roof. After the first heavy snowfall the snow was a metre thick. When it melted, the water would normally have drained off – but the tympanum got in the way, so it leaked right through the roof and floors instead.<sup>25</sup>

Pressure was also put on the foreign architects. The long slabs of housing in the *sotsgorods* were supposedly bleak and monotonous. Such criticism came not only from the government, but also from Russian architects' associations. The western architects were told that their 'formalism' was associated with capitalism, and that they had lost their way in their abstract pursuit of a new architectural form.<sup>26</sup>

In their analysis of the work and position of western architects in the Soviet Union, the neo-Marxist Italian architectural historians Manfredo Tafuri and Francesco Dal Co concluded that the architects

22 See M. Bliznakov, "The realization of Utopia," in Brumfield, *Russian architecture*, 145–75.

23 Hannes Meyer, *Welche ist die Rolle des Architekten im sozialistischen Aufbau?* (typescript, June 28, 1931), Deutsches Architekturmuseum, Frankfurt am Main, Hannes Meyer archives 164–902–003.

24 De Wit, Interview. See note 1.

25 Interview by Arno Nicolaï with Lotte Stam Beese (Emmen, August 20, 1986), manuscript, HNI, NICO d641.

26 Otto Das, Gerrit Oorthuys and Max Risselada, *Russische architectuur en stedenbouw 1917–1933* (Delft: Technische Hogeschool, 1969), 25.

had been accused of producing 'inhuman cities'.<sup>27</sup> Unfortunately, the authors cite no sources for this accusation but they do make clear that it had an ideological basis. In the architects' urban models the Soviet state saw the ideology of the 'working city', which it wanted to replace with an ideology of 'the city for socialist man'. In other words, what 'inhuman' really meant was 'unsuitable for socialist man', who would be alienated by functionalist, objective architecture.

We do not know whether Lotte discussed with her colleagues what it was that made the *sotsgorods* 'human' or 'inhuman', but she did have her own ideas about what had gone wrong with their designs.

In a way it's understandable that our architecture failed in Russia, for New Objectivity calls for structural perfection – the perfection of the machine. In Russia you were forced to build with unskilled workers and materials of extremely variable quality, assuming they were available at all – so you simply couldn't achieve such perfection. You had to use axes or pickaxes to make openings in the walls for the windows. Iron was sometimes available, but it soon ran out. On the balconies the reinforcing bars were left sticking out of the concrete, and there were never any railings, because there was nothing to make them with. And the open slabs were completely unsuitable for the windy steppe. They looked quite dreadful out there, without any paving or greenery (Fig. 7). We just couldn't work the way we wanted to.<sup>28</sup>

### Mission Impossible?

Does all this mean that the work of the western architects and urban planners, which came to an end during the 1930s, was a fiasco? Architectural historians writing forty to eighty years after the event have generally concluded that it was not a success. The Dutch architectural historian Koos Bosma's recent article "New socialist cities: foreign architects in the USSR" states that the architects must very soon have realised this was 'mission impossible'.<sup>29</sup> They had not yet acquired enough experience of building cities in Europe to put it into practice in the Soviet Union and they did not have the slightest idea what was meant by a 'socialist city'. To make matters worse, they had to build districts rather than whole cities. The failure of architect Han van Loghem's plans in the late 1920s for the Siberian town of Kemerovo, where lack of materials forced him to build wooden houses rather than avant-garde architecture, was a warning that the foreign architects who followed him would be no more successful.

Bosma's conclusion is surely correct. But could Beese have foreseen all this, and did she too think of her work as 'mission impossible'?

She travelled from Brno to Kharkov at a time when her fellow architects were still euphoric about the Soviet ideal. It is not known whether she was then aware of how her predecessors had fared. But even if she had been, her enthusiasm for the communist ideal and her abhorrence of national socialism were so great that she had no reason to take a critical view of things.

When reviewing her years in Russia she made no mention of specific results. She did acknowledge the difficulties and imperfections of the project, and had to concede that the Stalinist regime had become a dictatorship. This was hard for her, which is not surprising given her firm belief at the time that a socialist society was feasible. She said conflicting things about life under the Stalinist regime. She supposedly felt free, and was never afraid, except on that one occasion when she and Stam 'refused work'. Yet she couldn't help wondering.

Not a day went by without something shocking. This was a world where black was white and white was black. You saw so many incomprehensible things – things you couldn't help seeing, but couldn't find an explanation for. And the explanation only came after so much else had happened. Then you could suddenly see the underlying causes.<sup>30</sup>

On the other hand, there was the challenge of 'creating order amid chaos' together with her fellow architects. Her recorded recollections make clear that she did not see her work in the Soviet Union as 'mission impossible'. It had not been an easy project, but she would not have missed the experience for the world. By broadening her horizons, it had given her life meaning.<sup>31</sup> However, in acknowledging that the *sotsgorods* had not been built according to plan, or to her own and the Russian authorities' satisfaction, she also made clear that the mission had not been fully accomplished. She had been prevented from creating order amid chaos. This must have been a great disappointment to her.

Translation from Dutch into English: Kevin Cook.

27 Tafuri and Dal Co, *Architektur*, 220.

28 See note 1.

29 Koos Bosma, "New Socialist Cities: Foreign Architects in the USSR 1920–1940," *Planning Perspectives* 29, no. 3 (2014), 301–328, DOI: 10.1080/02665433.2013.825994 (accessed June 6, 2014).

30 See note 1.

31 Lotte Stam Beese, *Farewell speech* (Rotterdam City Council, February 1968), HNI, STAB d50.

### Hanneke Oosterhof

PhD candidate at University of Technology Eindhoven



Hanneke Oosterhof (MA) is an external PhD Candidate in Architectural History and Theory at University of Technology Eindhoven (NL). Her research focuses on the subject of an interdisciplinary biography (architecture, history, gender) of the urban architect Lotte Stam-Beese (1903–1988). She studied History and Dutch at Teacher Training College in Nijmegen and Culture Sciences at Open University Nederland. She graduated with a thesis on the life and work of the decorative artist Agathe Wegerif-Gravestein (1867–1944). She worked for over thirty years in the museum sector, both as a manager and as a curator, and has published in the field of social history, woman history and culture history.

E-mail: [hoosterhof@home.nl](mailto:hoosterhof@home.nl)

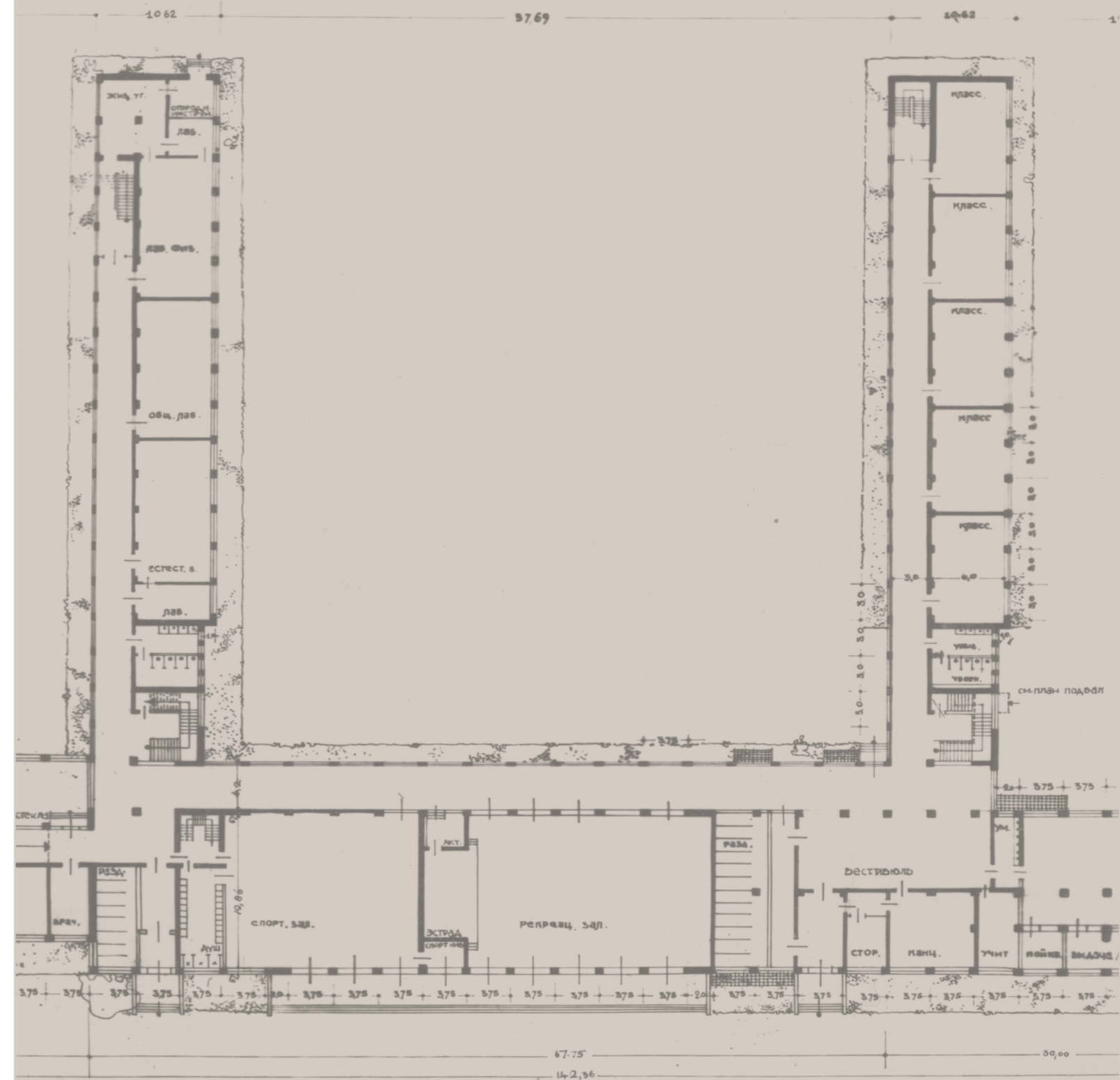



Alain Bonnet

## Pioneers and Organisations

### Introduction

To ask the question of women's involvement in the professions of architecture or designer raises the much more general question of the place given in professional activities to this part of the population defined from its social position rather than from its physiological reality. In what way would the very nature of the professions of architect or designer really differ from all other activities for which the career of women has been hindered or concealed? And according to what historical modalities has the access of women to these professions gradually been made possible and visible?

The following four studies in this chapter relate to the slow emergence and difficult recognition of women in the professions related to the construction of buildings and the organisation of spaces from different points of view. By observing the beginnings of this history at the end of the nineteenth century and during the first decades of the twentieth century, and by analyzing the objective conditions of access to the exercise of these professions, either through educational institutions or through professional associations, these studies retrace a history that is often misunderstood or forgotten. The history of the pioneers of architecture in Italy or France in the early 20th century, the life of a German artist who was active in the Dada movement, the forgotten role of women who participated in the collective adventure of the CIAM – all these stories expose the difficult paths of women in search of professional recognition, and the trace that they have left in the evolution of these professions.

## Women Pioneers in Civil Engineering and Architecture in Italy: Emma Strada and Ada Bursi

It is well known that Italian culture has discriminated against women in the fields of education and profession. Why is this? Before and immediately after the Second World War, women civil engineers and architects used strategies to overcome their gender marginality. Did these strategies influence their experiences within the profession and the recognition they received? What were the factors that enabled women to enter the patriarchal spheres of the professions? What were the roles of the first female civil engineers and architects in Italy and especially in Turin which was the capital of industry? What motivated their choice of profession and how were these women received in the male-dominated professional world? The history of two almost unknown female pioneers, Emma Strada and Ada Bursi, helps answer these questions and it gives rise to new ones.

Keywords: architects, Bursi, engineers, pioneers, polytechnics, Strada

Italian law never explicitly denied women access to university, but in the nineteenth century the presence of women at university was low. From 1867 to 1900 there were 224 women graduates in Italy. In the same period 49.8% of female degrees were taken in northern Italy and 26.9% of this number were from Turin.<sup>1</sup>

In the first decades of the twentieth century the number of women graduates did not increase much. This is also related to the fact that in 1910–11 there were 791 girls in all high schools of the Kingdom of Italy, while the number of boys was 13,551.<sup>2</sup>

In Italy, university was free and open to anyone who qualified, until 1923 when Education Minister Giovanni Gentile passed a law limiting access to university to those who had attended the following high schools: *liceo classico* (classical lyceum), *scientifico* (scientific lyceum) or *artistico* (artistic lyceum). In the same year, secondary schools began to segregate boys and girls.<sup>3</sup> Girls' secondary schools were created and soon became the only choice for women to study, preventing them from entering university which was now reserved for students coming from the above mentioned *licei*.

Since the two major Italian engineering schools, the Politecnico di Torino (Polytechnic of Turin)<sup>4</sup> and Politecnico di Milano (Polytechnic of Milan, 1863),<sup>5</sup> were founded in the northern industrial area, the first civil engineers came from Turin and Milan. It is known that these cities were not just the most

1 Cf. Michela De Giorgio, "Donne e professioni," in Anna Maria Malatesta (ed.), *I professionisti* (Torino: Einaudi, 1996), 455–456, vol. 10 of the collection *Storia d'Italia: Annali*.

2 Cf. Marino Raicich, "Liceo, università, professione: un percorso difficile," in Simonetta Soldani (ed.), *L'educazione delle donne: Scuole e modelli di vita nell'Italia dell'Ottocento* (Milano: Franco-Angeli, 1989), 168.

3 About fascist school policy in Italy see Jürgen Charnitzky, *Facismo e scuola: La politica scolastica del regime (1922–1943)*, (Firenze: La Nuova Italia, 1996).

4 The *Regio Politecnico di Torino* was founded in 1906 following the merger between the former military school *Regia Scuola di Applicazione per ingegneri* (established in 1859) and *Regio Museo Industriale* (established in 1863). Before starting the three years of the *Scuola di Applicazione*, students in engineering had to attend two preparatory years at the *Università di Scienze*. See: Giovanni Maria Pugno, *Storia del Politecnico di Torino* (Torino: Stamperia Artistica Nazionale, 1959), 32–149.

5 On the history of the *Politecnico di Milano* see: Ferdinando Lori, *Storia del R. Politecnico di Milano* (Milano: Tip. A. Cordani, 1941).

modernised in Italy, but they would soon become the centres of the post-war economic boom and the forefront of Italy's women's movement. Women would become a significant minority, active in the vicissitudes of post-war Italian civil engineering, architecture and design, rarely working alone since they were usually collaborating with male professionals.

The region of Piedmont was among the first to welcome women into universities which could give them access to professional orders.

Piedmont's standards of excellence were also helped by the presence of religious minorities, such as Jews and Waldensians, and were characterised by a level of education that gave girls access to higher education.<sup>6</sup> Although the presence of women was accepted in universities, it was not the same at the Regio Politecnico di Torino (Royal Polytechnic of Turin) which taught practical, applied sciences.

Reflecting the mentality of the time, technical studies were not at all considered feminine and, because of social pressure, women simply did not apply for them. Furthermore, the Politecnico was conditioned by its military school roots, thus by tradition it was more difficult for women to enter.

For a woman in Italy in the twenties, civil engineering or architecture were still an unusual choice of profession and in most cases women benefitted from family tradition. However, from the early thirties, girls' enrolment in courses of civil engineering and architecture was no longer seen as an exception. Indeed, from 1944 to 1947 the enrolment of women at the Faculty of Architecture in Turin (established at the Politecnico since 1929) increased at a rate faster than that of men.

In 1945–46, 25% of the school population was female and in the fifties and sixties the number of female graduates continued to grow, while the number of male graduates was static.<sup>7</sup> As in other European countries, the war was one of the factors that may explain this phenomenon.

At the Politecnico di Milano, the increase in female students enrolled was disproportionately higher than the general growth of the faculty. The numbers of women graduating was, however, lower and less consistent – in 1944 women made up 33% of graduates, but in 1962 they were just 24%.<sup>8</sup>

In 1951 just 17 female architecture students were enrolled at the Politecnico di Milano, a number that rose to 223 in 1969, anticipating women's professional emergence in the Italy of the 1960s.<sup>9</sup>

Very few women undertook an academic career. Among the first professors at the Politecnico di

Milano were the architects: Cini Boeri (1924, graduated in 1951), Raffaella Crespi (1929, graduated in 1955) and Franca Helg (1920–1989, graduated in 1945)<sup>10</sup>. Working at the Politecnico di Torino: Mariella de Cristoforo Rovera (1931–2001, graduated in 1955), Vera Comoli (1935–2006, graduated in 1961), Giovanna Maria Zuccotti (1926–2004, graduated in 1950).<sup>11</sup> Most of them became assistant professors or full professors in the eighties.

### Access to the Civil Engineering and Architecture Professions

Immediately before and after the Second World War, a significant number of women architects and engineers were born into an open-minded elite, less bound by gender roles. The issue of class and consequently the educational advantage, was also relevant for women's access to the professions.<sup>12</sup>

Women usually began their professional career working with their fathers, brothers or husbands, most of the time without signing their projects or receiving credit for their work. There were women who chose to remain anonymous, working alongside their husbands or for their mentors and studio owners, or sometime in teams.<sup>13</sup> This is one of the reasons there are just a few publications covering Italy, which focus on this specific subject.<sup>14</sup> One other reason is that for a long time it was

<sup>10</sup> Among the first generation of women architects and designers who emerged in the post-war period were: Gae Aulenti, Cini (Maria Cristina) Boeri, Anna Castelli Ferrieri and Franca Helg, who all born between 1920 and 1927. All graduated from the Politecnico di Milano between 1945 and 1953. Cf. Simona Grasselli and Mirella Valota, "Nel segno di Estia: Istruzione Politecnico e Professione in Architettura delle Donne a Milano" (diss. Politecnico di Milano, 1994–1995), 54.

<sup>11</sup> For the Politecnico di Torino see: Vittorio Marchis (ed.), *Progetto cultura società: La scuola politecnica torinese e i suoi allievi* (Torino: Associazione Ingegneri e Architetti ex Allievi del Politecnico di Torino, 2010), 202–203, 216–217, 220–221.

<sup>12</sup> As noticed by Catherine Rossi: Antonia Astori, Emma Gismonde Schweinberger and Cini Boeri all had brothers who had studied in the field of architecture. Giogina Castiglioni and Maria Luisa Belgiojoso were both daughters of celebrated architects Piergiacomo Castiglioni and Ludovico Barbiano di Belgiojoso of the rationalist group BBPR. Cf. Catherine Rossi, "Furniture, Feminism and the Feminine: Women Designers in Post-war Italy, 1945 to 1970," *Journal of Design History* 3 (2009), 248.

<sup>13</sup> In the post-war Italian context, while architects-designers such as Franco Albini, Tobia Scarpa and Ico Parisi achieved a considerable degree of recognition, their partners, Franca Helg, Afra Scarpa and Luisa Parisi, have been marginalised. Outside Italy, the extensively documented partnership of Charlotte Perriand and Le Corbusier; Charles and Ray Eames and Sadie Speight and Leslie Martin illustrate the problems the female partners had during collaboration. To explore the dynamics of creative partnerships, see: Whitney Chadwick and Isabelle De Courtivon (eds.), *Significant others: Creativity and intimate partnerships* (London: Thames & Hudson, 1993).

<sup>14</sup> On women architects see: Gisella Bassanini, "Le 'madri dell'architettura moderna': Alcuni ritratti nel panorama italiano e straniero," *Parametro* 257 (2005), 20–23; Claudia Mattogno, "Muse, committenti, progettiste: Il lungo percorso delle donne in architettura," *Tria* 10 (2013), 71–84; Maria Grazia Eccheli and Mina Tamborrino, *donna Architettura: Pensieri idee e forme al femminile* (Milano: Franco-Angeli, 2014). On women designers/architects see: Nicoletta Livi Bacci, Anna Luppi and Milly Mazzei (eds.), *Design delle Donne* (Milano: Arnoldo Mondadori arte, 1991); Tiziana Occeppo and Anty Pansera (eds.), *Dal Merletto alla Motocicletta: Artigiane/Artiste e Designers nell'Italia del Novecento* (Milano: Silvana Editoriale, 2002), Exhibition catalogue; Anty Pansera and Maria Teresa Chirico De Biasi, *Nientedimeno: Nothing Less: The strength of female design* (Torino: Allemandi & C., 2011).

<sup>6</sup> In 1881, at the University of Turin, Lidia Poët was the first woman in Italy to graduate in law. She was a Waldensian.  
<sup>7</sup> These data are deduced by the author from: Associazione Ingegneri e Architetti, *Annuario ex Allievi Politecnico di Torino 1961* (Torino: Stamperia Artistica Nazionale, 1961), 31–35.  
<sup>8</sup> The disparity is larger than would be expected, despite a greater trend in Italy than elsewhere in Europe for abandoning one's studies. In the 1960s, women entered higher education in ever greater numbers and by 1962 made up nearly half the student body. Cf. Politecnico di Milano, *Annuario* (Milano: Politecnico di Milano, 1970), 466.  
<sup>9</sup> Cf. Raffaella Crespi, "Donna e Architetto," in Barbara Mapelli (ed.), *Donna e Istruzione Politecnica: Atti del convegno, Milano 1987* (Milano: Franco Angeli, 1987), 87.

customary not to write the designer's full name, therefore scholars could not tell if there was a woman or man behind the title of civil engineer or architect.

On 3 August 1919, a law abolished marital approval –the requirement that a wife needed her husband's approval to work– and allowed the admission of women to exercise any work or profession and hold public positions with just a few exceptions.<sup>15</sup> At that time, there were more female graduates from the University of Turin than any other university in Italy.

Between 1920 and 1930, both in Europe and in Italy, female architects became more numerous, even though public opinion perceived architecture as a 'profession for men'. The minority status of women in architecture and the civil engineering professions has a direct relationship to the fascist regime and the continuing dominance of conservative Catholicism. Indeed, in fascist Italy, women never exceeded 10% of the 108,000 professionals. Among the total number, 16 women were architects, 60 were lawyers, 30 were dentists, 297 were doctors and 500 were writers and journalists.<sup>16</sup>

Despite Benito Mussolini's disapproval, a small group of women architects, designers and urban planners began to grow in Italy. Some of these professionals could even design and carry out their own works. It was a silent revolution. These women showed extraordinary drive in obtaining cultural and professional emancipation which could be achieved only by acquiring a solid technical education.

To our knowledge, the first woman civil engineer in Italy was Emma Strada (1884–1970). She graduated from the Politecnico di Torino in 1908, but after that year the presence of women at the Politecnico remained sporadic and almost random.<sup>17</sup> This was probably because social pressure was still strong.

After Emma Strada, Gaetanina Calvi (1887–1964) graduated in 1913 from the Politecnico di Milano (the first woman to do so). Maria Bortolotti Casoni (1880–1971) –who graduated in engineering in 1918– was the first Italian woman to be licensed as civil engineer on 18 July 1919 thanks to the decree that opened all professions to women.

Only in the twenties did a few women graduate in architecture.<sup>18</sup> In 1925 Alexandra Biriukova (Vladivostok, 1895 – Toronto, 1967) and Elena Valentini Luzzatto (1900–1983) completed their

studies at the Regia Scuola di Architettura di Roma (Royal School of Architecture of Rome, founded in 1919). Valentini was probably the first qualified female architect in Italy. Two years later, Annarella Luzzatto Gabrielli (1873–unknown) also graduated in architecture in Rome.<sup>19</sup>

In 1922 Elvira Luigia Morassi (1903–2002) became the first woman to follow architectural courses at the Politecnico di Milano, graduating in 1928 with fellow student Carla Maria Bassi (1906–1971), who had enrolled in 1923.<sup>20</sup> Stefania Filo Speciale (1905–1988) graduated from Naples in 1931 and in 1939 Ada Bursi (1906–1996) graduated from the Politecnico di Torino.

In 1933 a Faculty of Architecture opened at the Politecnico di Milano, although it would take some years for women to become a visible presence. Just nine women enrolled in this faculty that year, 6% of the total.<sup>21</sup>

Luisa Lovarini (1900–unknown) (Fig. 1), Attilia Vaglieri Travaglio (1891–1969) (Fig. 2), Maria Bortolotti Casoni (1880–1971) (Fig. 3) were women who worked in the thirties signing their names on architectural and urban projects. These women rejected Mussolini's claim of that women do not build.

In the thirties, the lack of women in Italian architecture and civil engineering fields is largely explained by fascist rules that sought to confine women to their maternal role and exclude them from highly skilled professions.<sup>22</sup>

Between the wars in Italy, women were hostages in their own home. They were under patriarchal authority and deprived of civil rights. They could not inherit assets and were excluded *de facto* from practising in many professions.<sup>23</sup>

In a widely-read interview, Mussolini offered his own opinion on the absence of women architects at this time. He asserted:

The woman must obey [...]. She is analytic and not synthetic. Has she ever done architecture in all these centuries? Ask her to build you a mere hut, not even a temple! She cannot do that. She

19 Cf. Anna Maria Speckel, "Architettura moderna e donne architetture," *Almanacco della donna italiana* 13 (1935), 120–134.

20 Cf. Annamaria Galbani, "Donne al Politecnico di Milano: Studenti e docenti dalle origini al 1950," in Annamaria Galbani (ed.), *Donne politecniche: Atti del Convegno e Catalogo della Mostra - Milano, 22 maggio 2000* (Milano: Libri Scheiwiller, 2001), 57, 62.

21 If we compare this data to Germany, we find that, between 1920 and 1930, in the various Technische Hochschulen (Technical College) the percentage of women students in architecture varied between 1,5% and 5%.

22 On Fascism's position on women see: Victoria De Grazia, *How Fascism Ruled Women: Italy, 1922–1945* (Berkeley: California University Press, 1991), 1st Italian ed. *Le donne nel regime fascista* (Venezia: Marsilio, 1993); Francesca Delle Vedove, *La Donna nel Fascismo tra segregazione e mobilitazione* (diss. Venezia: Università ca' Foscari, Facoltà di Lettere e Filosofia, 2000–2001). On women architects in Italy under the Fascism see: Luisa Maria Caruso and Cristina Giannoccaro, "Architettrici. Le donne progettiste del ventennio fascista" (diss. Politecnico di Milano, 1998–1999).

23 Women voted for the first time in 1946 as full Italian citizens in the referendum on the Italian monarchy and election of the Constituent Assembly. By 1950 a bill on working mothers became law, thus provided paid leave before and after childbirth and prohibited the dismissal of mothers during pregnancy and for a year after the child's birth. This legislation did not, however, cover professional architects and engineers.

15 Cf. the law: *17 Luglio 1919 n. 1176 art. 7*. Women are excluded from judicial appointments and from work concerning the military defence of the state.

16 Cf. Sara Sesti, "Donne di Scienza: Un percorso da tracciare," in Annamaria Galbani (ed.), *Donne politecniche: Atti del Convegno e Catalogo della Mostra - Milano, 22 maggio 2000* (Milano: Libri Scheiwiller, 2001), 13–14.

17 According to Bongiovanni, after Emma Strada, the followings women graduated in civil engineering from the Politecnico di Torino: Teresa Bertino (1914), Laura Lange (1933), Rosita Peverelli (1941) and Anna Maria Demichelis (1948). Cf. Margherita Bongiovanni, "Le donne al Politecnico di Torino," in Vittorio Marchis (ed.), *Progetto, cultura e società: La scuola politecnica torinese e i suoi allievi* (Torino: Associazione Ingegneri e Architetti ex Allievi del Politecnico di Torino, 2010), 77.

18 In Europe, the Finnish Signe Ida Katarina Hornborg (1862–1916) was the first female to graduate in architecture in 1890 in Helsinki and possibly the first female qualified architect in the world. She graduated from the Polytechnic Institute of Finland as an 'extra student', the term given to part-time students, since women were not admitted as full-time students at that time.



Fig. 1. Luisa Lovarini, Worker's house at the V Triennale di Milano, 1933. From: A.R. "La Casa del Dopolavorista," *Edilizia moderna* 10-11 (1933), 72-73 (Copyright free).

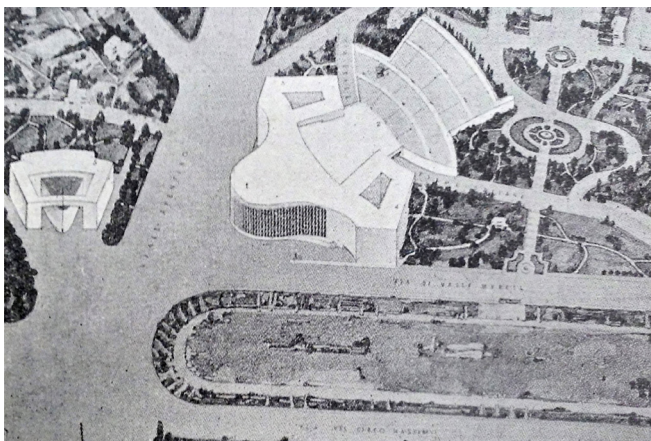

Fig. 2. Attilia Travaglio Vaglieri, Project for the Music district in Rome, ca.1935. From: Speckel, "Architettura moderna e donne architetto," 130 (Copyright free).

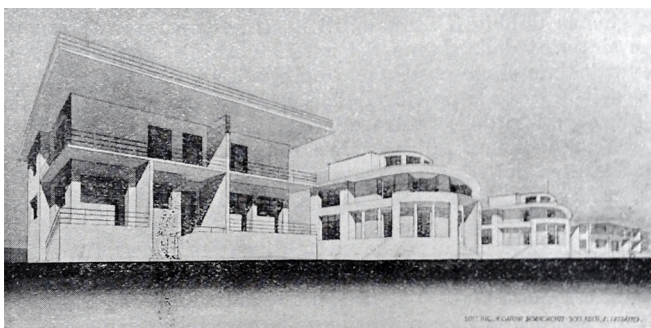

Fig. 3. Maria Bortolotti Casoni (civil engineer) and Elena Luzzatto (architect), Project for small modern houses at Ostia Mare, 1932. From: Speckel, "Architettura moderna e donne architetto," 133 (Copyright free).

is foreign to architecture, which is a synthesis of all arts, and this is a symbol of her destiny.<sup>24</sup>

In 1932, Mussolini declared to the French journalist H el ene Gosset that the real task of women is: '[...] above all to be a wife and mother. The real place of woman in modern society, is now like before, in the house'.<sup>25</sup> On the pages of the number 14 of the magazine *Critica Fascista* (1933, 7), we read: '[...] the Fascist woman must be a mother, those who have children, a supporter and director of new lives [and it is necessary for her to undergo] an intense spiritual evolution towards sacrifice, self-forgetfulness, versus anti-individualistic hedonism'.<sup>26</sup>

Ferdinando Loffredo reaffirmed male superiority:

female emancipation is as contrary to the interests of the family, as it is contrary to the interests of the race. The woman must return under the complete subjugation of man: the father's or husband's subjection; and therefore spiritual, cultural and economic subjugation.<sup>27</sup>

There was a Fascist strategy against women's work outside home that began with educational programmes for girls. The *Decalogo della piccola italiana* (the Italian girl's handbook) stated: '[...] 3. You serve your country also by sweeping your house; 4. Civil discipline begins with the governance of the family; [...] 8. The woman is primarily responsible for the destiny of a people; [...]'.<sup>28</sup>

Mussolini's statement of the tasks of the housewife, who was considered the generator of the race, so alienated women from working in architecture that only a few started working in that field.

As elsewhere in Europe, women architects worked mainly on private housing projects, interior design and decorative arts and, as a result of Fascism, it was nearly impossible for women to enter public contracts and competitions. However, in 1935 the *Almanacco della donna Italiana* (Almanac of Italian Woman) praises the achievements of some professional architects, whose cases remained exceptions.<sup>29</sup>

24 From: Emil Ludwig, *Talks with Mussolini* (Boston: Little Brown, 1933), 168.

25 'Il loro vero compito   soprattutto quello di essere spose e madri. Il vero posto della donna nella societ  moderna,   attualmente come in passato, nella casa.' Translated by the author from: Piero Meldini, *Sposa e madre esemplare: Ideologia e politica della donna e della famiglia durante il fascismo* (Firenze: Guarnaldi, 1975), 77.

26 '[...] la donna fascista deve essere madre, fattrice di figli, reggitrice e direttrice di vite nuove [per essa occorre] una intensa evoluzione spirituale verso il sacrificio, l'oblio di s , l'anti-edonismo individualistico'. Translated by the author from a quotation by Katrin Cosseta, *Ragione e sentimento dell'abitare: La casa e l'architettura nel pensiero femminile tra le due guerre* (Milano: Franco-Angeli, 2000), 28-29.

27 'L'emancipazione femminile, come   contraria agli interessi della famiglia   contraria agli interessi della razza. La donna deve tornare sotto la sudditanza assoluta dell'uomo: padre o marito; sudditanza e quindi inferiorit : spirituale, culturale ed economica'. Translated by the author from: Ferdinando Loffredo, *Politica della famiglia* (Milano: Bompiani, 1938), 369.

28 '[...] 3. La patria si serve anche spazzando la propria casa; 4. La disciplina civile comincia dalla disciplina familiare; [...] 8. La donna   la prima responsabile del destino di un popolo; [...]'. Translated by the author from: Meldini, *Sposa e madre esemplare*, 48.

29 See: Speckel, "Architettura moderna e donne architetto," 121-134.

In Turin, the interior designer M. Besso won first prize for the furnishing of new shops on the main street of the city, via Roma.<sup>30</sup> The enlargement of this street was the largest urban renewal promoted in Italy during Fascism. Many architects were involved in architectural reconstruction, but there were no women among them. As the case of Besso testifies, women were confined to interior design tasks.

The example established by these female architects clearly demonstrates the level of excellence that women had to reach in order to fill traditionally male positions.

### Italy's First Woman Civil Engineer: Emma Strada in Context

Emma Strada (Torino, 1884–1970) finished the Liceo Classico Massimo d'Azeglio high school in Turin in 1903 (Fig. 4). Her decision to attend this school showed her intention to go on to university. The same year she was enrolled in the preparatory course in Engineering Sciences at the University of Turin.<sup>31</sup> This would later allow her to enroll in the Scuola di Applicazione per Ingegneri (Appliance School for Engineers). On 5 September 1908, she graduated with honours from the Regio Politecnico di Torino and finished third out of the 62 students enrolled in her course. Emma Strada was Italy's first woman graduate in Civil Engineering.<sup>32</sup>

She became assistant to Luigi Pagliani, who was the director of the Gabinetto di Igiene Industriale (Cabinet of Industrial Hygiene) at the University of Turin and a lecturer at the Politecnico in the course of Hygiene. As a result of social constraints, there was no chance a woman could have an academic career and consequently she had to work for her father and brother, who were both engineers. Her father, Ernesto Strada, was a provincial councilor of Turin and directly involved in the city's building policies.

Turin has been a developed industrial city since the early twentieth century and has seen a complete transformation of its socio-cultural outlook. The city was revitalised and expanded and many civil engineers and architects were involved in the urban transformation process, although to our knowledge no women were involved.



Fot. cav. Lovazzano.  
**La signorina Emma Strada di Torino,  
prima laureata ingegnere in Italia.**  
[Vedi il *Corriere*].

Fig. 4. Photographic portrait of Emma Strada, the first woman civil engineer in Italy, 1908. Propriety of the author (Copyright free).

In 1910, Emma's father closed his studio in Turin and the archival documents do not show that he opened a new studio in the city under his name, perhaps because he had already moved his professional activities to Calabria.<sup>33</sup> These were the years when professionals and workers from the North led the modernisation in southern Italy.

In Catanzaro, Emma probably helped her father on the construction of the auto-moto-funicular railway, junction Catanzaro-Sala (Fig. 5).

After Emma father's death in 1915, she worked with her brother Eugenio. In Liguria and in Piedmont she also designed some railway sections.<sup>34</sup> As a woman civil engineer she succeeded remarkably well in the railway sector which was traditionally male.

In Turin, she worked on a project for a children's nursery in the Crocetta district although the drawings preserved in the historical city archive do not bear her signature.<sup>35</sup> From the pages of the *Annuario in Almanacco della Donna Italiana* we know that in 1937 Emma had her professional studio in Turin (via Bove n. 2).<sup>36</sup>

After the First World War, Piedmont was the most industrialised region of Italy. Because of the war, women took the place of men in factories, offices and public services, thus women demonstrated their working ability. This event contributed to the change of mentality and established a different conception of social relationships.<sup>37</sup>

At the end of the Second World War, women had gained civil rights like those of men (law decree 2 February 1945) and gender equality (Italian Constitution 1948) nevertheless, equality at work would only be fully legally recognised in 1977 (law 9 December 1977 n. 903).

30 Cf. Speckel, "Architettura moderna e donne architetto," 131.

31 Cf. "Registro di matricola relativo all'allieva Emma Strada," Archivio Storico Università di Torino (or ASUTo), *Registro immatricolazione studenti Facoltà di Scienze Fisico-matematiche*, 19.

32 On Emma Strada see: Margherita Bongiovanni, "Strada, Emma," in Béatrice Didier, Antoinette Fouque and Mireille Calle-Gruber (eds.), *Le dictionnaire universel des Créatrices* (Paris: Editions des Femmes, 2013), Vol. 3, 4127; Caterina Franchini, "Emma Strada and Ada Bursi: The First Female Civil Engineer and Architect in the Italian Capital of Industry, Turin," in Jorge Correia (ed.), *Ist International Meeting EAHN: European Architectural History Network, Book of Abstracts, CD of Papers* (Guimarães: EAHN, 2010), 216–225; Pina Novello and Elena Marchis, "Emma Strada: Temi, forme e maestri della formazione politecnica, progetti, disegni e opere della professione di progettista," in Associazione Italiana di Storia dell'Ingegneria, *Storia dell'Ingegneria: Atti del 3° Convegno Nazionale, Napoli 19–20–21 Aprile 2010* (Napoli: Cuzzolin, 2010), Vol. 2, 1047–1056.

33 Cf. *Annali Paravia*, microfilm (1910), ASCTo.

34 Emma Strada's projects and works are listed and partially described in: Bongiovanni, "Emma Strada," 94–95; Novello and Marchis, "Emma Strada," 1051.

35 Scuola materna Crocetta, 1868–1980, ASCTo, Archivi Aggregati.

36 Cf. Silvia Bemporad, "Annuario," *Almanacco Annuario della Donna Italiana* 15 (1937), 475.

37 During the war, women belonging to the upper classes joined the Red Cross and enrolled in the *Consiglio Nazionale delle Donne Italiane* (National Council of Italian Women), that was inspired by patriotic and emancipationist values. Cf. Rosa Rosá, "Le donne cambiano finalmente," *L'Italia Futurista* 27 (1917), 2.



Fig. 5. Ernesto Strada and Daniele Mercegalia, with the collaboration of Emma Strada, "Auto-moto-funicular" railway junction Catanzaro-Sala, 1910. Ancient picture displayed on the site, piazza Roma Catanzaro (Copyright free)..

Since women's aspirations were more ambitious and they were conscious of their own value, the disappointment of being cut off *en masse* from the working world became a stark reality. Even though Turin could include many engineers in multiple industries, women trained in engineering did not find their future careers there. Only in the eighties would women engineers enter Turin industry and then only marginally.<sup>38</sup>

In 1957, 148 professional female engineers and 147 architects were enrolled in the registers of professional orders, but it was very difficult for women to succeed because they were unable to get work.<sup>39</sup> The legacies of a misogynistic regime proved the main obstacle for the majority of women engineers and architects, preventing their entry into professional practice. This galvanised the women to form a professional association.

### First Italian Association of Women Engineers and Architects

On 26 January 1957, women engineers and architects of Turin and Milan, who had gathered in 1955 at the Exhibition of Mechanics in Turin, legally founded the Associazione Italiana Donne Architetto e Ingegnere - AIDIA (Italian Women Engineer and Architect Association). Emma Strada was one

38 Cf. Patrizia Audenino and Paola Corti, "Donne e professioni liberali: studio, carriera e famiglia (1918–2000)," in Patrizia Audenino and Paola Corti (eds.), *Donne e libere professioni: Il Piemonte nel Novecento* (Milano: Franco-Angeli, 2007), 30.

39 Cf. Margherita Bongiovanni and Nicoletta Fiorio Plà, "Emma Strada, ingegnere dal 1908: La vita della prima donna ingegnere attraverso le fonti archivistiche istituzionali e private," in Associazione Italiana di Storia dell'Ingegneria, *Storia dell'Ingegneria*, 1045.

of the founders and the association's first national president. Among the founding members, the contribution of the electrical engineer from the Politecnico di Torino (graduated in 1933) Anna Enrichetta Amour (Milano, 1908 – Torino, 1990) was crucial.<sup>40</sup>

In 1953, while studying for her master's degree in industrial engineering at Columbia University (New York), Enrichetta Amour was approached by the British-American organization Women's Engineering Society - WES and through this, upon her return to Italy, she became the initiator of the foundation of AIDIA, of which she was national secretary and editor of the association's newsletter (since 1956).<sup>41</sup>

Early issues of the AIDIA newsletter identified the professional advantage of family connections; male family members could introduce their female relatives into the profession.<sup>42</sup> Since its first issues, the newsletters reveal that women faced real forms of discrimination in the profession: problems of less pay, hostility from male colleagues and cases of being fired rather than promoted.

The incompatibility of professional and family life was a key issue. In the January-February 1956 newsletter we read: 'the first duty of the young married graduate is towards her family' and recommended that 'remaining single was necessary in order to advance in her career'.<sup>43</sup>

At AIDIA's second national conference in Turin, Emma Strada introduced the debate about professional claims and opportunities for women in the field of technology. In 1970 she agreed to organize the III International Conference of Women Engineers and Scientists in Turin supported by WES. The topics included: family duties and professional women. Unfortunately, Emma Strada passed away just a few months before the event.

The theme of incompatibility between professional and family life remained, but it was perceived in a reverse logic: the problem became the family. In 1972 one AIDIA member declared that the family was 'the biggest obstacle in women's liberation'.<sup>44</sup>

### The First Woman Professional Architect in Turin: Ada Bursi

The first woman to practise as a professional architect in Turin was Ada Bursi (Verona, 1906 –

40 The other founding members were: Vittoria Ilardi, Laura Lange, Ines del Tetto, Lidia Lanzi, Adelina Racheli Domenighetti.

41 Cf. Bongiovanni, "Le donne al Politecnico di Torino," 79.

42 Cf. Associazione Italiana Donne Ingegnere e Architetto, *Notizie dall'A.I.D.I.A.* 5 (1957), 3.

43 Cf. Associazione Italiana Donne Ingegnere e Architetto, *Notizie dall'A.I.D.I.A.* 1 (1956), 4.

44 Cf. Associazione Italiana Donne Ingegnere e Architetto, *Notizie dall'A.I.D.I.A.*, 20 (1972), 5. For AIDIA relationships with feminism see: Rossi, "Furniture, Feminism and the Feminine," 249–250.

Castiglione Torinese, Torino, 1996).<sup>45</sup>

When she was a girl, Ada Bursi moved from Verona to Turin with her family and attended the Regia Scuola femminile Margherita di Savoia (Royal Women School Margherita di Savoia).<sup>46</sup>

In the second half of the 1920s, she attended the school of the painter Felice Casorati (1883–1963) and, influenced by the friendship of the painter Mino Rosso (1904–1963), she completed some graphic works in futuristic style.<sup>47</sup> In fact the Futurist avant-garde movement, especially in its initial period (until 1910), offered women new opportunities of expression in terms of originality, authenticity and self-confidence.<sup>48</sup>

In the early 1920s, the many women who wrote, often in a provocative way, in the periodicals *L'Italia Futurista* or *Roma Futurista*, progressively changed their artistic activity to social interest. Soon, the role of woman varied between the reaffirmation of the strength and power gained in time of war and the return to their traditional boundaries.

In 1929, Ada Bursi published her tempera drawings, in the specialised magazine *La Casa bella*, of the linoleum flooring (Fig. 6) that she had designed for the architect Giuseppe Pagano Pogatschnig (1896–1945).<sup>49</sup>

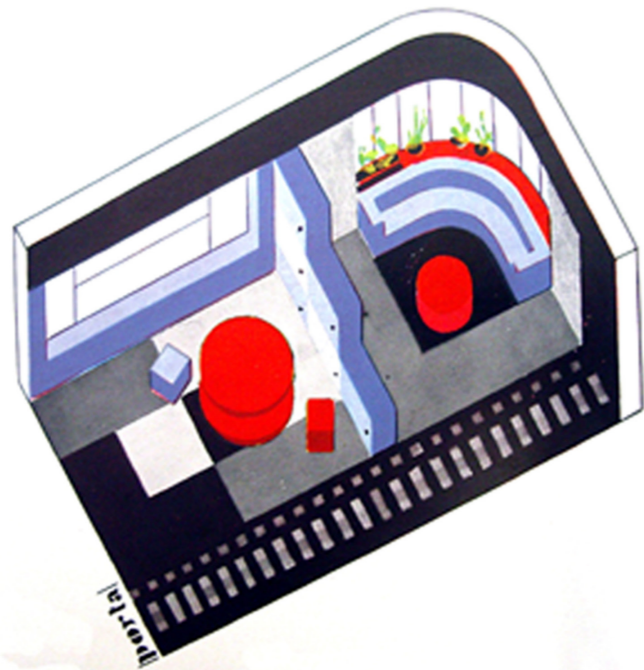

As Ada Bursi's drawings show, the interior materials of the Modern Movement were designed to be continuously renewed and replaced. The taste for colour re-enters the home by the use of inlays in *linoleum* that underline perfect geometries and smooth surfaces of modernity.

Since the twenties, the home had become the ground for applying the scientific theories on organization of domestic work. In the thirties the political, ethical, aesthetic and social canons were redrawn. The debate on the modern rational housing, already

Fig. 6. Ada Bursi's drawing for the linoleum flooring of a living room with veranda, 1929. From: Pagano Pogatschnig, "Pavimenti moderni," 44 (Copyright free).

introduced in Germany in the late 1920s, come to the fore. At the same time, the status of the housewife was affirmed because the lady of the house could no longer depend on the help of servants. Large homes were replaced by smaller apartments to be rationally designed and needing flexible furniture which was easy to clean.<sup>50</sup>

The first specialised magazines in architecture and interior design *Casabella*, *Domus*, *Quadrante*, *Stile* saw the "new woman" working in the field of architectural criticism as well as interior design. The art of decorating and beautifying the house was made popular by Lidia Morelli, Elisa Ricci, Vanna Piccini and Amina Polito Fantini. Articles in *Domus* naturalised woman's presence in traditionally female realms of creativity and allied their skills to domestic and reproductive duties.

In 1939, *Domus'* editor Gio Ponti put women back in their traditional place by describing needlework as: '[...] the natural work of women, it should be the only work for women, it is work that does not take her away from the home and does not distance her from the cradle and the hearth'.<sup>51</sup>

Bursi's artistic skills led her to find work in advertisement graphics. She worked for Avigdor's fabric in 1929, Gancia's spumante in 1930, and after the Second World War she designed the poster for the Exhibition in Mechanics (Turin, 1946). For the Municipality of Turin, she continued to work on graphic design for Via Roma up to 1954, as well as for those of Porta Nuova (the Central train station).

In 1933, Bursi became a member of the Partito Nazionale Fascista<sup>52</sup> (National Fascist Party) and in the same year she exhibited her paintings with the group of Futurists at the 5a Mostra Regionale del Sindacato Fascista di Belle Arti (5th Regional Exhibition of the Fascist Syndicate of Fine Arts). Soon she was well integrated in the artistic milieu of the time, although it was still almost exclusively male.

In 1936, Bursi participated in the VI Triennale di Milano (6th Milano Triennial) exhibiting some carpets together with the architect Ettore Sottsass sr. (1892–1953) and earning awards for the design of a tapestry and a set of coffee cups.<sup>53</sup>

50 To study the complex relationship women-home between the wars, see: Cosseta, *Ragione e sentimento dell'abitare*. Between 1915 and 1945 the house became the centre piece of a lively critique by women which emerged in novels, essays, manuals and specialist magazines. The analysis of these sources shows the unstable balance between reason, which requires a functional home, and feeling that refuses mechanistic and impersonal living. On the same subject see also: Stefania Berrino, "Casa di donna: Analisi dello spazio domestico tra le due guerre" (diss. Politecnico di Torino, 2006).

51 'Il lavoro di ricamo [...] è il lavoro naturale della donna, dovrebbe essere il solo lavoro della donna, è il lavoro che non la toglie dalla casa, che non la allontana dalla culla e dal focolare.' Translated by the author from: Gio Ponti, "Per l'affermazione delle industrie femminili italiane," *Domus* 139 (1939), 65–66. Women's "natural" domestic role was used to explain - and contain - the increasing number of women architects emerging in the late 1940s. It is interesting to notice that Enrichetta Ritter and Lisa Licitra Ponti were part of *Domus's* editorial team and Gae Aulenti worked with Ernesto Rogers at *Casabella-Continuità* on its relaunch in the 1950s.

52 Unione provinciale Fascista dei professionisti e degli Artisti Torino, Historical Archive OAT, folder "Ada Bursi".

53 Cf. Perlo, "Bursi Ada," 176.

45 Cf. Caterina Franchini, "Bursi, Ada," in Béatrice Didier, Antoinette Fouque and Mireille Calle-Gruber (eds.), *Le dictionnaire universel des Créatrices* (Paris: Editions des Femmes, 2013), Vol. 1, 698.

46 From the Historical Archive of the Ordine degli Architetti, pianificatori, paesaggisti e conservatori della provincia di Torino (or OAT), folder "Ada Bursi".

47 Cf. Luisa Perlo, "Bursi Ada," in Enzo Godoli, *Dizionario del Futurismo* (Firenze: Vallecchi, 2001), Vol. 1, 176.

48 Cf. Rosá, "Le donne cambiano finalmente," 2.

49 Cf. Giuseppe Pagano Pogatschnig, "Pavimenti moderni," *La Casa bella* 8 (1929), 44–46.

Probably, after having attended Biennio speciale in Architettura (two years' courses in architecture) at the Accademia Albertina di Belle Arti (Fine Arts Academy) she could enrol at the Faculty of Architecture of the Politecnico di Torino.

It is interesting to note that research carried out at the Accademia Albertina archives revealed no evidence of Ada Bursi's presence. Nevertheless, recently discovered documentation concerning the Biennio speciale in Architettura shows that women's presence on architectural courses in the fine arts academy was not an exception.<sup>54</sup>

In 1927, out of a total of 12 candidates to enter the biennium in architecture, four were women: Alidia Besso, Dellia De Benedetti, Severina Olivetti and Laura Tamagno.<sup>55</sup> When Giuseppina Agliodo took the exam the same year, she was the only woman among eight candidates to become a professor of architectural design.<sup>56</sup>

On 27 October 1938 Ada Bursi graduated in architecture (85/100 points) from Politecnico di Torino where she was the only woman in her class.<sup>57</sup> That year there were 13 women architects and 23 women engineers in Italy.<sup>58</sup>

The same year of her graduation, Bursi passed the Esame di Stato (a state exam to become a professional architect), with 239 points out of 280,<sup>59</sup> and she became a self-employed architect. On 24 October 1940 she became a member of Ordine degli Architetti (Architects Association).

She was a volunteer assistant of the professor Giovanni Muzio at the Politecnico for the courses of Architectural Composition and Elements of Architecture and Survey of Monuments.

Not having found a future academic career at the university, which was still the domain of men, she looked for employment in public administration. In 1941, she was hired in the Ufficio Tecnico Comunale (City Technical Office) where she worked until 1971.

At the end of 1945, Bursi was the only female among the 26 founders of the Gruppo di Architetti Moderni Torinesi "Giuseppe Pagano" (Modern Architects Group "Giuseppe Pagano") created in memory of the architect who died in a concentration camp.<sup>60</sup> This is explained by the fact that Ada

54 The presence of women at the Fine Art Academy in Italy, especially in architectural sections, needs to be investigated.

55 *Esami di ammissione ai Corsi Superiori della R. Accademia delle Belle Arti e del R. Biennio Speciale in Architettura, Versamento della terza parte di tasse, 25 giugno 1927 (anno V°) al regio Uffici del Demanio di Torino, Torino 25 giugno 1927, 1010, 2N, Historical Archive of the Accademia Albertina delle Belle Arti (or AABA).*

56 *Ripartizione delle tasse scolastiche e delle propine degli esami per il conseguimento del Diploma di Professore Architettonico, Torino, 25 aprile 1927, To 118, Historical Archive AABA.*

57 Giuseppa Audisio was first to graduate in Architecture in Turin in 1930 but she did not practice the profession.

58 Cf. De Giorgio, "Donne e professioni," 479.

59 *Università degli Studi di Roma, Certificato Superamento Esame di Stato (n. posizione 244, n. partenza 2299) Roma 25 luglio 1939 – XVIII, folder "Ada Bursi," Historical Archive OAT.*

60 Cf. Emilio Pifferrì, "Fondazione del Gruppo di Architetti Moderni Torinesi Giuseppe Pagano," *Agorà 3* (1945), 16.



Fig. 7. Amedeo Albertini, Gino Becker and Ada Bursi, Modular furniture at the exhibition of furniture by architects and craftsmen of Piedmont, association Pro Cultura Femminile, Turin 1946. From: Albertini, Bursi, Becker, "Mobili da Torino," 16 (Copyright free).

Bursi did not share the anti-Semitic ideology of the regime. Her membership to the fascist party was determined by her need to find work.

In 1946, with her male colleagues architects Amedeo Albertini (1916–1982) and Gino Becker (1913–1971), Bursi worked as a furniture designer making a series of modular furniture (Fig. 7) for the Mostra di arredamento di architetti e artigiani piemontesi (Exhibition of furniture by architects and craftsmen of Piedmont) held in Turin at the women association Pro Cultura Femminile and promoted by Felice Casorati and Paola Levi Montalcini.<sup>61</sup> Among the exhibitors were also Carlo Mollino (1905–1973), Gio Ponti (1891–1979) and Ettore Sottsass sr.

The modular furniture was designed to contribute to change living models; architects wanted to express a new freedom of household life. The female role was becoming more standardized and based on the efficiency of Taylorism.

In 1947, Albertini, Becker and Bursi wrote to the Commission Arredamento of the VIII Triennale di Milano to propose the mass production of their modular furniture.<sup>62</sup> They also sent the Commission *Oggetti per la casa* (Object for the house) projects for a desk set, tea sets and faucets.<sup>63</sup>

It is well known that most architects operating in the country had also practiced as designers. In fact, the training of architects included furnishings and furniture. Until the early 1950s, this close-knit relationship between architecture and design saw furniture perceived as part of the

61 On the exhibition see: Amedeo Albertini, Ada Bursi and Gino Becker, "Mobili da Torino," *Domus* 216 (1946), 16; Daniele Regis, *Gino Becker Architetto: Architettura e cultura a Torino negli anni Cinquanta* (Torino: Gatto Editore, 1989), 49–51, 111–114.

62 Amedeo Albertini, Ada Bursi and Gino Becker, *Letter to Commission Arredamento of the VIII Triennale di Milano*, letter n. 201, 16/01/1947, S.DIS/M.9–2°, Archive Amedeo Albertini (or AAA). The author thanks Alberini's family.

63 Letter 31/12/1946, S.DIS/M.9–2a, AAA.

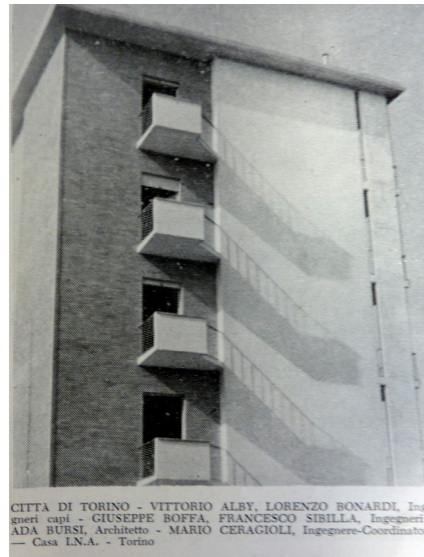

Fig. 8. Ada Bursi et al., Social housing in Turin - Istituto Nazionale delle Assicurazioni - INA Gestione Casa, ante 1954. From: Melis, "Per una città migliore," 317 (Copyright free).

architectural environment. Ada Bursi typified this approach as other colleagues did later. Margherita Bravi (1921–2006) and Luisa Castiglioni Deichmann (1922) designed a built-in wardrobe, a table and chairs for the IX Triennale di Milano in 1951. Castiglioni and Bravi studied at the Politecnico di Milano, graduating in architecture in 1946 and 1948, respectively.<sup>64</sup>

While working in the city technical office in 1946, Ada Bursi also participated together with architects Albertini and Becker in tendering for the cemetery to those fallen during the liberation of Turin.<sup>65</sup> The project, anti-monumental and metaphysic won the second prize as the first prize went to Carlo Mollino.<sup>66</sup>

The trend for male-female partnership was one way women dealt with their minority status. AIDIA's newsletter also noted the importance of collaboration for improving women's career opportunities, and a partnership was a popular choice amongst architects. Male partnerships promised more commercial success as well as the continuity required to sustain a practice

when the demands of raising children arose.<sup>67</sup>

In the late 1940s, Bursi showed her artistic creativity by creating some furniture reminiscent of abstract painting and sculpture.

In the city office she designed social housing (Fig. 8) and many school buildings for the City. This experience shows once again how gender also affected the type of commissions women received, in fact most of the work was in a domestic context or concerned children. This demarcation of "feminine" realms within architecture, linked to women's maternal and domestic duties, ensured that the gender hierarchy within the profession remained intact.

In 1954, Ada Bursi contributed in designing the Piccolo Torino nursery school<sup>68</sup> where she created a



Fig. 9. Ada Bursi, School in via Duino, Turin 1969. Photo by Caterina Franchini.

terracotta decoration that surrounds the facades and the mosaic interior decoration of the entrance hall, thus demonstrating her artistic sensitivity and ability.

At the early 1960' she worked on the project of two twins primary schools ("Giulio Gianelli", 1961 and "Giacomo Leopardi", 1961, opening 1962–63) in the new planned Vallette suburb, a worker residential neighbourhood.<sup>69</sup>

It was only at the end of the 1960' that Bursi was entrusted with the execution of an entire school complex (1968–1970) in a worker residential suburb, between Fiat factories of Lingotto and Mirafiori.<sup>70</sup> There, the architect applied her experiences to the building which is distinguished by the relationship between the interior and exterior spaces (Fig. 9). On the access road, there are four main wings which were built parallel to each other, interspersed with large green areas and a garden, design by Bursi, used for outdoor activities and connected with other buildings at the

back with covered walkways. New technologies characterized the design of the brick work facades: window frames made out of aluminium.<sup>71</sup>

64 In Milan, from 1945 to the early 1970s, 47 architects have emerged as furniture designers. See: Rossi, "Furniture, Feminism and the Feminine," 243. On woman presence at the *Triennale di Milano* see: Alessia Caserio, Alessandra Gulmini and Luca Mariani, "Le signore della Triennale: La presenza femminile italiana nella storia dell'esposizione milanese (1923–2000)," (diss. Politecnico di Milano, 1998–1999).

65 Gino Levi Montalcini, "Memoria di Partigiani," *Agorà* 6 (1946), 33–35.

66 Cf. Regis, *Gino Becker*, 49–51.

67 Cf. Associazione Italiana Donne Ingegnere e Architetto, *Notizie dall'A.I.D.I.A.* 5 (1957), 3.

68 *Via Giacinto Collegno 65, "Piccolo Torino" - Circostrizione 3*, dis. 101, Archive of the Comune di Torino - Settore Edilizia Scolastica (or ACT SES). The signature of Asa Bursi do not appears on the project drawings nevertheless documents contained in Bursi's folder at the Archivio Storico della Città di Torino (ASTo) demonstrate her authorship. *Pratica individuale di Bursi dott. Arch. Ada, Architetto di 1° classe*, Registro a matricola, vol. 11, 780, ASTo, Città di Torino.

69 See: Fondazione Tancredi di Barolo, "Scuola elementare Giulio Gianelli" and Fondazione Tancredi di Barolo, "Scuola elementare Giacomo Leopardi".

70 *Via Duino*: 544 0A (Scuola Materna); 544 0A bis (Scuola Elementare); 545 0A (Scuola Media), ACT SES. Signature: architetto Ada Bursi.

71 See: Diana Lomas, "Complesso scolastico (scuola materna, elementare, media), Torino, via Duino, 1969, Ada Bursi," in Maria Adriana Giusti and Rosa Tamborrino, *Guida del Piemonte: Architettura del Novecento (1902–1906)* (Torino: Umberto Allemandi C., 2008), 317.

Bursi worked as a professional architect during the reconstruction of post-war Turin, when the number of *architette* (women architects) started to rise: there were 43 women architects in 1961 in Turin out of 306.<sup>72</sup> She was also involved in the urban growth of the 1970s with some projects of urban design and restoration, until she left the *Ordine degli Architetti* in 1975 and ended her career.<sup>73</sup>

## Conclusion

Emma Strada and Ada Bursi epitomize the complexity of questions related to the choice of a liberal profession and the difficulties that women needed to challenge especially in terms of social-cultural pressure. On one hand, the case of Emma Strada shows us how the family background was determinant for the success in the profession. On the other hand, the biography of Ada Bursi confirms that the boundaries between architecture, interior design, industrial design and graphic design are typical of the Italian case and are indifferent to gender. However, cultural norms confined professional work of women architects in areas related to the home and motherhood.

Some questions are still to be investigated and some of these are listed below. Were women civil engineers and architects intended to devote themselves completely to their career? How did their private lives influence their professional choices? Has participation in women's associations to defend the right to exercise a liberal profession actually helped women in their work?

Now we know that thanks to these professionals the status of women in engineering and architecture in Italy began to change in the second half of twentieth century.

## Caterina Franchini

Politecnico di Torino - Interuniversity Department of Regional & Urban Studies and Planning - DIST, Italy



Caterina Franchini, Ph.D. in History and criticism of architectural and environmental assets, Master in Conservation of historic towns and buildings. She is Assistant Professor of History of Architecture at the Politecnico di Torino - DIST. She has been lecturing History of Visual communication and Design at the Politecnico di Torino since 2010 and History of Modern Design and History of Interior Design at the University Studies Abroad Consortium since 2006. Her research interests include gender studies in architecture, industrial and interior design. She is Assistant Project Leader of the European project "Women's creativity since the Modern Movement - MoMoWo".

E-mail: d004200@polito.it

<sup>72</sup> Cf. Associazione Ingegneri e Architetti, *Annuario*, 31–35.

<sup>73</sup> *Cancellazione dall'Albo degli Architetti delle Province di Torino, Asti e della R.A. Valle D'Aosta, Torino 27 maggio 1975 (Prot. n. ° 205)*, folder "Ada Bursi," Archive OAT.

## Lost in the History of Modernism: Magnificent Embroiderers

The Dada fine artist Hannah Höch's subversive advice for embroiderers reflected her own art that rejected ideals of femininity and domesticity. Embroidery's marginalized position of, and connection to the home allowed women to develop expressive designs forbidden to painters and sculptors. Complex relationships between embroidery design, industry, socialist, communist and fascist ideologies existed. The identification of the provenance of Austrian, Italian and German textiles led to the determination of external influences that shaped and enhanced the object meanings. Held in British collections they were created by women who taught, ran ateliers and rejected the propaganda they were exposed to and became part of a larger resistance movement. Taking alternative viewpoints to apply the special accent of modernism to a traditional art form. These unique works communicate a political and social vision of an idealized world and express the impact of various political ideologies on women's lives. The works' received significant visibility in their day, but the decorative appearance excluded them from full modernist classification. It is readily apparent that these embroiderers achieved works of excellence during the inter-war period.

Keywords: design, embroidery, politics, industry, modernism

[Embroidery] is an art and ought to be treated like one ... you, craftswomen, modern women, who feel that your spirit is in your work, who are determined to lay claim to your rights (economic and moral), who believe your feet are firmly planted in reality, at least Y-O-U should know that your embroidery work is a documentation of your own era.

Hannah Höch<sup>1</sup>

### Introduction

This story seeks to demonstrate how the influence of Höch became beneficial for embroiderers and attempts to illuminate their understanding of the period. While working as an embroidery and dress pattern designer at the Ullstein publishing houses, Höch was able to exert sustained encouragement to embroiderers. The highly regarded embroiderer, Emmy Zweybrück's relationship with the publishers is symbolised in an embroidered tulle textile celebrating the Ullstein publisher, Alex Koch's sixtieth birthday. The paper unfolds the complexity of circumstances surrounding the embroiderers and the ideological pressures they endured as applied arts were used in political propaganda. An earlier paper 'Politics and Trade in Emmy Zweybrück – Prochaska's influential textile designs in the Needlework Development Scheme,' introduced her works in the context of the scheme and the historical aspects.<sup>2</sup> This paper extends the debate, including works by other designers, for example Elsi Kay Kohler, in the context of modernism. It presents the relationship between embroidery design and socialist, communist and fascist ideologies during the periods when the regimes had their greatest peak of influence. In these modern works the artist always communicated a message with political or social context, depicting an ideal world, expressing

1 Madeleine Boucher, "Art or Craft?: Hannah Höch's Collages Embraced the Conflict Between Art and Craft, Dada and Commercialism," <https://www.artsy.net/article/madeleineb-art-or-craft-hannah-hochs-collages-embraced> (accessed 2014).

2 Sandra Heffernan, "Politics and Trade in Design: Emmy Zweybrück-Prochaska's Influential Textile Designs in Needlework Development Scheme Collections," *Textile* 5, no. 1 (2007), 46–61.

the impact of regimes ideologies on their lives through the traditional art form of embroidery. Exceptional circumstances after the conflict of World War One, the fragmentation of the Austro-Empire and the Russian Revolution brought political and socio-economic changes to life as it was known, while the modernist schools were forming. During a period of intense political activity and economic deprivation the embroiderers were open to different viewpoints on social and political issues. They presented unique responses in the special accent of modernism into their art. More so than any other medium, embroidery allowed for the blurring of old and new and for impregnating tradition with innovation and modernism. This article analyses the processes and meanings of embroidery to explain the complex relationship between designers, commerce, politics and society.

During the 1930s, in an unusual relationship with Scotland's thread industrialists, J & P Coats Ltd., the designers from Austria, Hungary and Germany produced hand and machine embroideries for education, exhibition and trade purposes contributing to Coats' Needlework Development Scheme (NDS) collection.<sup>3</sup> Coats were a textile thread industry leader wholly owning forty-three mills, including Mez AG in Germany, Cucirini Cantoni Coats in Italy; Harlander in Austria and the Anglo-Hungarian Thread Co. in Hungary. In collaboration with educators, Coats circulated and re-circulated the textiles between various education and amateur organisations throughout the United Kingdom from 1934–62. Coats' organizational framework for the scheme was immense and communication was taking place on an international level, encouraging an active, creative, cross-fertilisation of ideas between different cultures. Coats' role in the encouragement of such designs becomes less mysterious when seen in the light of the demands required to succeed in business in such difficult times, when ruthlessness and manipulation as a daily occurrence is considered.<sup>4</sup> In order to succeed, designers had to negotiate market forces to create objects that related to contemporary life and fashion. Coats' extensive communication networks connecting many countries in Europe with the British Isles ensured modernist textile design made an impact on British design.

The present research of embroideries and written material in university and museum collections was led by a forensic process in a material culture framework to identify the provenance and meanings of the textiles. The cross-referencing of information from these sources created typologies, which provided answers to the identification and provenance of the textiles and their artist and designers and the way their works are the embodiment of the times. For the purposes of clarity, 'designer' refers to artists who designed for exhibition and industry while being artists.

## Embroidery and Modernism

Embroidery played a significant role in the development of the modernist image. In the 1890s the German sculptor Hermann Obrist in collaboration with the manager of his Munich atelier, Bertha Ruchet, created embroidery designs stitched by Italian women.<sup>5</sup> Exhibited in Munich, the embroideries were the first modern art designs; later, the works became icons of the then emerging Jugendstil. Contemporary reviewers and artists rejoiced in the creative, subtle variations of colour and texture.

The situation for embroiderers varied from place to place and became less favourable at the turn of the twentieth century. Educational opportunities for women were limited and as they received the vote and were given a voice in political realms, their participation in public and artistic life was perceived as a threat. The impact of embroidery designs across the 1920s and 1930s was limited by male perceptions of artists and critics who wrote about art and design, for example, influential critics such as the German Karl Scheffler, a future Bauhaus lecturer, swayed opinion as he published anti-feminine art ideas.<sup>6</sup>

In 1914, in defiance of the gender divide in education, Emmy Zweybrück established her own embroidery atelier and school in Vienna, *Kunstgewerbliche Schule und Werkstätte*,<sup>7</sup> accepting advanced students of embroidery from abroad as well as from Vienna (Fig. 1).<sup>8</sup> Advertisements for the School were regularly placed in the German fine art and applied art journals.<sup>9</sup> Her private school for girls aged six to fourteen and fourteen to eighteen, was recognised by government and commissions were received from wealthy patrons of Vienna and abroad. Zweybrück quickly developed an international reputation as from 1916 her work frequently received favourable reviews in *The Studio*, *Die Kunst*, *Deutsche Kunst und Dekorative (DKD)*, *Stickereien und Spitzen (Stickereien)*. Zweybrück was said to use the arts to alleviate children's depression after World War I. A



Fig. 1. Emmy Zweybrück. Published in *Deutsche Kunst und Dekorative* 1925, 79.

5 M. Logan, *Hermann Obrist's Embroidered Decorations* (London: The Studio, 1896), 9 and 98–100.

6 J. Anger, "Forgotten Ties: The Suppression of the Decorative in German Art and Theory 1900–1915," in Christopher Reed (ed.), *Not at Home the Suppression of Domesticity in Modern Art and Architecture* (London: Thames and Hudson, 1996), 132.

7 School of Drawing and Applied Art.

8 Zweybrück graduated from the *Osterreichisches Museum für Kunst und Industrie Kunstgewerb* (Academy of Applied Arts) in Vienna studying in a curriculum steeped in the Secession.

9 A. S. Levetus, "The Zweybrück School of Drawing and Applied Art in Vienna," *The Studio: A Magazine of Fine and Applied Art* 92, no. 402 (1926), 181–3, <http://pbc.gda.pl/dlibra/doccontent?id=17152> (accessed June 2, 2017).

3 Sandra Heffernan, "Design from Artefacts: Issues in Aesthetics: Collecting, Education, Making and Marketing in J & P Coats' Needlework Development Scheme: 1934–62" (PhD diss., Glasgow School of Art, 2004).

4 Sandra Heffernan, "Stitch Kings: The Influence of J&P Coats on Textile Design Education," *International Review of Scottish Studies* 37 (2012), 97–120.

large student work by Helli Fritz portrays children looking forlorn with downcast heads.<sup>10</sup> It survives in an American collection.

Despite the difficult circumstances Zweybrück received international acclaim in 1925 when her works were included in the Austrian Pavilion at the 1925 Exposition des arts décoratifs et industriels modernes (Exhibition of Modern Decorative and Industrial Arts) and received more recognition in major design journals.<sup>11</sup>

### Embroidery in a Modernist Style

In the late 1920s the Wall Street crash heightened economic chaos and tensions, and political leaders were encouraged to promote their acceptance of modernism. Embroidery was used to enhance the luxurious impression and ambience of modern architecture. The S.S. Bremen, a north German Norddeutscher-Lloyd Liner was a symbol of Germany's recovery from the War and was used in advertising propaganda to signal the official acceptance of modernism.<sup>12</sup> Zweybrück was commissioned to design embroidered tulle cloths for the Bremen (Fig. 2).<sup>13</sup> The luxurious impression and ambience was enhanced by her nature inspired designs in a subdued monotone modern effect (Figs. 3 and 4). They were made at the Vereinigte Werkstätten (Cooperative Workshops), in Munich, which drew considerable support from the Third Reich. Dedicated to the production and sale of furnishing and homewares, the Vereinigte Werkstätten was promoted in magazines, eliminating the distinction between the fine and applied arts since the late nineteenth century.<sup>14</sup>

Highlighting close connections between Zweybrück's atelier and Coats and their promotion of contemporary design is another Bremen tulle work that was promoted as 'from a set of cloths for the Bremen' in the Victoria & Albert Museum's 'Modern Embroidery Exhibition' in 1932. Information on the subtle modernist message accompanied the image in *Stickerein* and *Modern Embroidery*, a special number of *The Studio*.<sup>15</sup> The result of the exhibition was recognition of the merger in design of the varied characteristics of tradition and modernism by way of techniques and design.

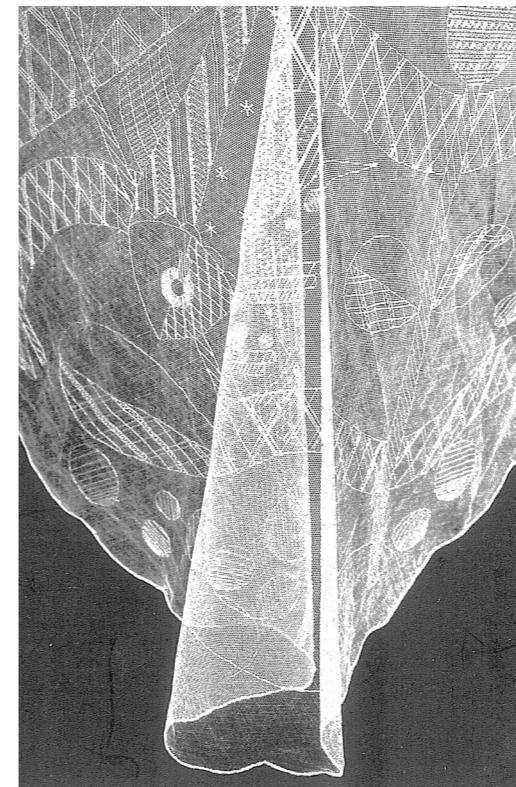

Fig. 2. Emmy Zweybrück's Bremen textile detail. Published in W.P., "Emmy Zweybrück: Tülldecke für den salon des ozeanexpress Bremen," *Stickereien und Spitzen* (1931), 42.

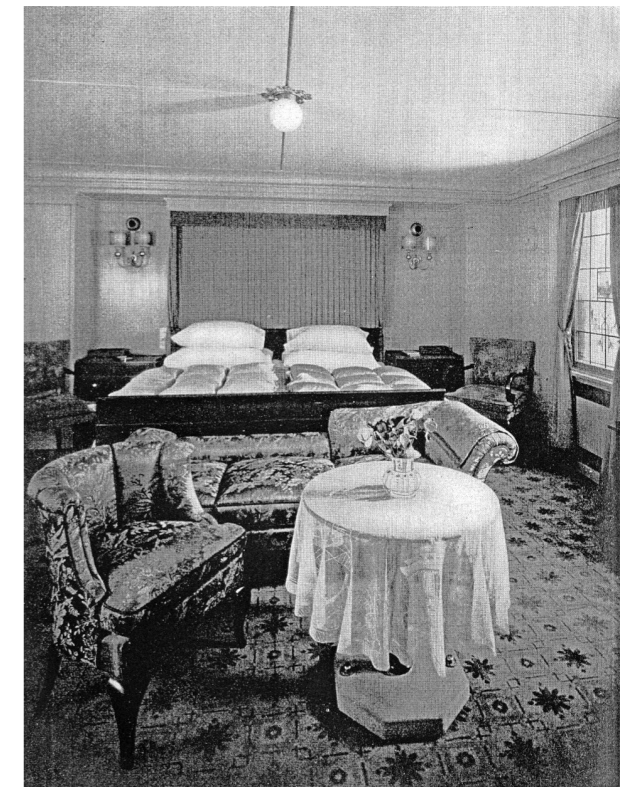

Fig. 3. Emmy Zweybrück's textile in the Bremen first class saloon. Published in Fritz August Breuhaus de Groot, *Der Ozean Express Bremen* (Munich: Verlag F Bruckman AG, 1930), 138.



Fig. 4. Emmy Zweybrück's textile in the Bremen first class bedroom. Published in Fritz August Breuhaus de Groot, *Der Ozean Express Bremen* (Munich: Verlag F Bruckman AG, 1930), 140.

<sup>10</sup> Marge Hiller, letter to author, May 20, 2003.

<sup>11</sup> "Österreich auf der Pariser Ausstellung," *Deutsche Kunst und Dekorative* 57 (1925–26), 78, [http://digi.ub.uni-heidelberg.de/diglit/dkd1925\\_1926/0092?sid=eb07fa64d28f87eae5373badc959e85](http://digi.ub.uni-heidelberg.de/diglit/dkd1925_1926/0092?sid=eb07fa64d28f87eae5373badc959e85) (accessed June 2, 2017).

<sup>12</sup> John Heskett, "Design in Inter-War Germany," in Wendy Kaplan (ed.), *Designing Modernity: The Arts of Reform and Persuasion 1885–1945* (London: Thames and Hudson, 1995), 257–86.

<sup>13</sup> Hans Schiebelhuth, "Neue Arbeiten von Emmy Zweybruck," *Stickereien und Spitzen* no. 31 (1930–31), 40–51.

<sup>14</sup> Anja Prößl-Kammerer, "Weaving for the 'Führer' Textile Art in National Socialism," *Textile Forum* 3, no. 3 (1996), 40–1.

<sup>15</sup> Mary Hogarth, *Modern Embroidery* (London: The Studio, 1933).

### Expressive Design with Subtle Messages

Zweybrück's ability to create innovative designs and willingness to allude to politics is evidenced in a work held in the Dundee University collection. In the emerging art deco style, the design from 1933 references Venice and appears to comment on the luxurious conditions enjoyed by the middleclass tourists travelling on liners (Fig. 5). A symbolic image of the SS Bremen cloth is included on the design's ship deck, along-with a peasant woman carrying a basket of fresh fruit. Perhaps a reference to the bountiful supplies of food enjoyed on-board by the middleclass tourists, compared with the 'mature fruit dispersed in traces' as in the text. This could be a reference to the pureness of the countryside where honest people worked hard, symbolism used as propaganda for power. It could also illustrate the contrast, which existed between the conditions of those in power, and the poverty of the rural poor, who endured hardship and a scarcity of resources. Edwin Redslob's aphorism surrounds the image:

May the sun bless over the holy distance,  
May the sails, glide, over free open spaces,  
May the gliding clouds, believe in the people who follow you,  
Mature fruit dispersed in traces.<sup>16</sup>

It was one of a series of designs including aphorisms by Redslob, who was Reichkunstwart (State Art Officer) in Hitler's national socialist regime.<sup>17</sup> In a different work, Zweybrück hailed Redslob as a hero, along-with her graphics teacher, Rudolf von Larisch.<sup>18</sup> Redslob was responsible for national art and culture questions and made numerous attempts to evolve a state policy for applied arts and design seeking to introduce a statute to improve recognition for applied artists.<sup>19</sup> At the time, German crafts people were under considerable threat as a result of the expansion of industry.

During this era Hitler recognized the potential for design to be a 'great improver', and national values and traditions were emphasized, while modernism was rejected.<sup>20</sup> Ideas of the blood and

soil 'Blut and Boden' formed the foundation of the perspective. They propagated the myth of the woman as guardian, child-bearer and protector, and the German home as the centre for both the raising of children and the welcoming of the returning warrior.<sup>21</sup> A 1935 issue of the monthly *Die Dame* perpetuated these ideals. Folk embroidery was paradoxically acclaimed in Nazi Germany, and applied art evolved in line with the national socialist view of the world. Both Hitler's encouragement for the traditional and opposition to modern art created a design niche for embroiderers, which they could only accept, because of the animosity towards their designs in the modern design realm.

Both the Fascists and Nazis were concerned with showing the family as a supportive family unit. Founded in 1919 in Italy, Benito Mussolini's fascism became a major political force, which used the applied arts to 'domesticate' the revolution, promoting fascism in everyday life.<sup>22</sup> Three designs attributed to Zwëybruck in 1934 show a shift in style to an ecclesiastical and fascist appearance and a willingness to incorporate oblique political commentaries.<sup>23</sup> The work *Madonna and Two Angels*, inscribed *Unsere liebe Frau* (My beloved Lady) portrays the Madonna as a young women surrounded by her two angels in a reflective pose. The Holy Family embroidery simply titled *Bildstickerei* (Embroidered picture) in *Stickereien* suggests this work was produced in a commercial environment, where the anonymity of both the designer and design was the norm (Fig. 6).<sup>24</sup> The text included in the design *Es ist ein Reis entsprungen Aus einer Wurzel zart* (A rose has sprung from a tender root) is perhaps a biblical reference to the Christmas song. Italian Fascist government's 'Battle for Grain' campaign to increase production of wheat and other cereals. The text subversively adapts a line, *Es ist ein Ros' entsprungen*, from a German Christmas carol, simply substituting the



Fig. 5. Emmy Zweybrück's *Sonnensegun*, including Edwin Redslob's aphorism. Published in W. Michel, "Gesticke Spruche von Emmy Zweybruck," *Stickereien und Spitzen* (1933–34), 58.

16 W. Michel, "Gesticke Spruche von Emmy Zweybruck," *Stickereien und Spitzen* no. 34 (1933–34), 57–9, Dundee University (DUNUC ARTS), 255; NDS 790.

17 Josef Hoffman, *Austrian Applied Arts: Oesterreichisches Kunstgewerbe: Les Arts Decoratifs Autrichiens: Ein Führer durch das Oesterreichische Kunstgewerbe* (Leipzig, Wien, Troppau: Verlag Heinz and Co., 1930), 186–191.

18 Schiebelhuth, "Neue Arbeiten," 45. In 1933 Redslob resigned from the National Socialists and was dismissed by the Nazis. Later in the 1930s Redslob wrote articles for the American *Design* journal. He established an university and set about finding banished artworks after the Second World War.

19 Brandon Taylor and Wilfried van der Will, *The Nazification of Art: Art, Design, Architecture, Music and Film in the Third Reich* (Winchester: The Winchester School of Art Press, 1990), vol. of the collection Winchester studies in art and criticism.

20 Paul Greenhalgh (ed.), *Modernism in Design* (London: Reaktion Books, 1990), 15.

21 S. Weißler, "Imprisoned within a Role: An Assessment of Arts and Crafts Production by Women under National Socialism," in Angela Odeekoven-Gerischer et. al. (eds.), *Frauen im Design: Berufsbilder und Lebenswege seit 1900 / Women in Design: Careers and Life Histories since 1900* (Stuttgart: Landesgewerbeamt Baden-Württemberg, 1989), 234–243, exhibition catalogue.

22 Denis Doordan, "Political Things: Design in Fascist Italy," in Wendy Kaplan (ed.), *Designing Modernity: The Arts of Persuasion 1885–1945*. (London: Thames and Hudson, 1995), 225–255.

23 Glasgow School of Art (GSA) F2; DUNUC ARTS: 996, NDS 733; DUNUC ARTS: 250, NDS 525.

24 W. Spring, "Vom Schenken," *Handarbeiten Aller Art* (1935–36), 35–8.



Fig. 6. Emmy Zweybrück's *The Holy Family*, courtesy of Dundee University, photo by Sandra Heffernan.

word Reis (rice) for Ros (rose). The simple modification would not be noticed at a glance.

Zweybrück's lively designs inspired by nature, folk, and ecclesiastical themes include elements unacceptable to the restrictive modernist agenda. Figurative, symbolic, colourful, and decorative designs reference traditional subjects, for example the Madonna, but are presented in a style acceptable to the dictates of those in power. Interestingly, the designs are not overtly fascist but subtly reference themes encouraged by those in power. Portrayals of women emphasised their traditional domestic roles and given Coats had prioritised the collection of ecclesiastical design it seems likely they would have indicated the type of work they preferred. Zweybrück's works were promoted in the German design journal *Stickereien und Spitzen*, which was approved by Hitler and Coats' Mez AG subsidiary company regularly posted full-page advertisements in this publication.

### Complex Connections

In November 1934, Zweybrück was appointed to Coats' Mez AG mill, Coats' German subsidiary, and hence the Harlander AG mill, near Vienna. Colin Martin, told of how the Harlander mill commissioned designs from her embroidery atelier in Vienna for promotional purposes in trade exhibitions.<sup>25</sup> These designs were used to advance Coats' commercial interests when negotiating with the national socialist regimes. Her design position at Coats offered employment in a difficult economic and political environment. The interplay of embroidery, design and industry manifested itself particularly clearly in Zweybrück's atelier work.

In 1938 Zweybrück visited New York and was interviewed by Emily Genaur, art critic of the World Telegram, in a discussion full of contradictions<sup>26</sup>. Zweybrück's comments reflect reluctance on her part to commit to such discussion. At a delicate time, Zweybrück was guarded in her comments regarding the influence of the annexation of Austria by the German Reich. She claimed the *Anschluss* meant little to Austrian artists. Genaur challenged Zweybrück's pro-fascist views, arguing that

25 George Martin, (Colin Martin's son) personal communication, August 2001.

26 Emily Genaur, "Italy a Leader?" *Art Digest* 12, August, 14, 1938.

'Mussolini's attempt to revive the spirit of ancient Rome had made Italy a leader in modern art.' Zweybrück denied any knowledge of the state sponsorship of the arts in Italy, but showed her approval of designs reflecting fascist ideals and values.

The economic crises in Austria and the harassment suffered by artists, made it more and more difficult to maintain an art school and an art studio under the premises of the aesthetic values, which were held in Vienna. Professor Heller, who organised an exhibition of Emmy Zweybrück's paper works in Vienna in 1989, suggests 'her work for Coats-Mez was in a certain way a contradiction against her self-understanding as an independent artist or craftswoman'.<sup>27</sup> Advertisements for her school appeared in *Handarbeiten Aller Art* as late as August 1939. It is likely it closed in the sense of it being a true atelier and school, but remained open for Coats' commissions.<sup>28</sup>

### Anonymously Depicting an Idealised World

Elsi Kay Köhler, a qualified architect, created designs that drew on the changing cultural conflicts existing in the process of modernization of Germany (Fig. 7). The image of the glamorous or threatening 'new woman', as presented in the media, was a distorted picture of reality.<sup>29</sup> The newly modern women had an ambiguous role in German mass culture, as the patriarchal vision for women fused with the growing consumer market where women were encouraged to redefine their bodies as commodities. The Weimar republic encouraged the consumer leisure culture of the *neue Frau*, using the print media to 'project' images of women posing as for beauty advertisements; the bobbed Dietrich hair-style was fashionable after her 1930s movie *Blue Angel*.<sup>30</sup> Coats promoted *neue Frau* styled images on the covers of *The Needlewoman* journal in 1935. From the late 1920s, Köhler's sophisticated works were promoted in key design and embroidery publications. Köhler resided in Leipzig until 1929, then moved between Leipzig and Vienna, until 1933–4 when she took up residence in Vienna, following Hitler's appointment as Chancellor. However, her works in the NDS were always attributed to Zweybrück.



Fig. 7. Elsi Köhler's *Madonna*. Published in Hans Schiebelhuth, "Bildstickerei," *Stickereien und Spitzen* (1929–30), 72.

27 Friedrich Heller, personal communication, February 8, 2002.

28 Following Zweybrück's death in 1956, the *Los Angeles Times* honoured her contribution to design education and industrial design.

29 Maud Lavin, *Cut with the Kitchen Knife: the Weimar Photo Montages of Hannah Höch* (New Haven: Yale University Press 1993), 56–7.

30 Shearer West, *The Visual Arts in Germany* (Manchester: Manchester University Press 2000), 175.

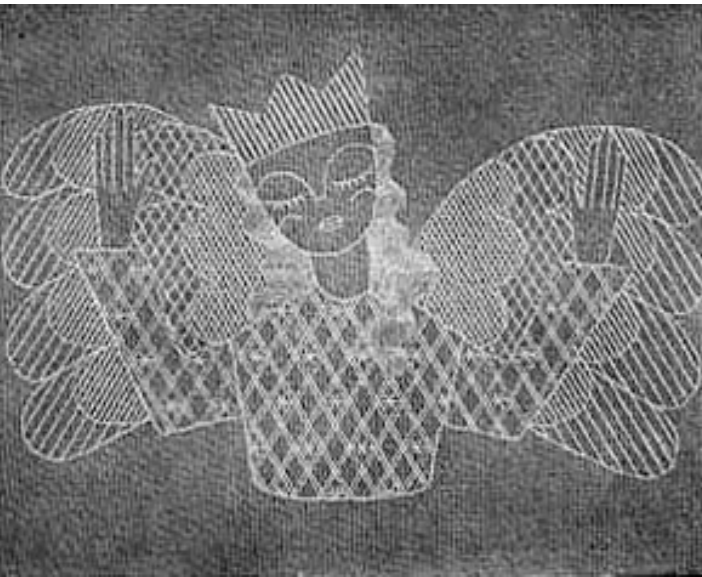

Fig. 8. Elsi Köhler's Angel's head. Published in Elsi Köhler, *Embroiderer Designers Sketchbook* (London: Pitman, 1952).

Köhler's 1929 *Madonna* has a colourful exuberance with both the Madonna and child in a protective pose (Fig. 8). The Madonna appears as a 'pure' woman with a fixed penetrating gaze, in the style of an icon, protected by the arms of the child. Decorative beads, sequins, silver and gold threads embellish the image, at a time when fine artists shunned such lush decoration. Another work, *Angel* features a black angel-like figure and appears to comment on the racist views of the ruling political regime.<sup>31</sup> Köhler worked in Scotland after her survival of the Nazi era, and there she undoubtedly would have feared harassment and have elected to erase her artistic past. Uncomfortable with the displeasure and cool reception the Scottish people demonstrated towards her artwork, while faced with the prospect of having to encourage their embroidery design, she would

have happily disowned her 'too modern' designs. Later in 1946, Kay Köhler, was employed as 'expert-in-charge' at Coats NDS in Glasgow and addressed the prestigious Friends of the Royal Society of Artists, in London. In *Embroidery as an Expression of National Characteristics* she appears to have compromised her own 'modern' beliefs while discussing the stylization and use of distorted figures in the German church embroideries, stating:

Just before the war, German embroiderers were making very modern church embroidery designs of distorted figures. The technique and colour were pleasing, but the designs were distasteful to religious people in that the distorted and top heavy figures were not the result of childhood's *naïveté*, but of a queer debased mentality which has not been confined to embroidery design only.<sup>32</sup>

### Oblique Messages in Religious Embroidery

While considering the intersections of historical layers, we must keep in mind the physical hardships endured as well as the negotiations of political, social and artistic challenges. Religion was at the periphery of National Socialist ideology and opposition to organised religion existed. In strongly

31 DUNUC ARTS: 253; NDS 745.

32 Elsie Kay Köhler, "Embroidery as an Expression of National Characteristics," *Journal of Royal Society of Arts* (1946), 59–71.

Catholic areas women refused to relinquish their habits and faith to meet the demands of the Nazi order and were often backed by the priest or a parson in their resistance.<sup>33</sup> An example of the way women interpreted the situation is shown in Käte Luise Rosenstock's embroidered net panel *St Francis* shows a heavily stylised saint figure surrounded by animals, birds, fish and flowers.<sup>34</sup> Rosenstock's designs received recognition in 1925 and featured regularly in the German journals, including her designs of a commercial nature perhaps produced for Coats' Mez AG. This suggests a professional link between Köhler and Rosenstock.

A stole by a student from the Stadt Schule für Handwerk und Kunstgewerbe (City School of Crafts and Arts) in Münster, features naïve figures with sacred emblems and includes the text "das wort bei Gott und am anfang war das wort" (the word was God and at the beginning was the word), referencing the opening chapter lines of the Gospel of John in the Bible. The young students, living in a chaotic and confusing world, would have been exposed to extensive propaganda in the schools. In an inhospitable climate, education for women was opposed by the National Socialists, who limited them to the study of 'appropriate' subjects at universities.<sup>35</sup> Another Munster student work portrays the Madonna crowned in thorns and crucified several times. Resonant of the misery suffered by Jesus, it alludes to his crucifixion and concludes with an excerpt from the Hail Mary (Fig. 9).<sup>36</sup> The student works from Münster are all the more interesting as they show the students' rebellious intent, when their own personal freedom was suppressed.

The women were creatively designing within contradictory limitations: on the one hand suppressed by the paternalistic views of the modernist era, but on the other encouraged in Central Europe by Fascist, and Nazi regimes to produce religious designs. The German ecclesiastical designs provide



Fig. 9. Student work from Stadt Schule für Handwerk und Kunstgewerbe, Munster. Courtesy of Robert Gordon University Archive, photo by Sandra Heffernan.

33 Jean Bethke Elshtain, *Women and War* (Chicago-London: University of Chicago Press, 1987), 190.

34 GSA F18.

35 Jennifer Loehlin, *From Rags to Riches: Housework, Consumption and Modernity* (Oxford: Berg 1999), 33.

36 Robert Gordon University: NDS 808.



Fig. 10. Embroidery made at Berlin's Verein für Deutsches Kunsthandwerk. Courtesy of Edinburgh College of Art Library, negative.

examples of the oblique referencing of political and social situations. A fascist presence existed in the familiar patterns of everyday life as design was used to influence people.<sup>37</sup> Embroidery threads were marketed by Coats throughout Central Europe labelled with emblems of power and production: sickles, guns, and shovels. The fascist support for handicraft ensured a market for Coats' threads. During the 1920s and 1930s Sir James Henderson, Managing Director of Coats from 1932, was resident in Italy, and would have dined with Mussolini's officials while negotiating deals for Coats.<sup>38</sup> The Fascist regime allowed companies to market a wide range of acceptable politically inspired images.<sup>39</sup> Coats would have been aware of this when they displayed the works in trade exhibitions. During this era classical forms and themes pervaded Italian political designs. Christian symbolism, myths, fables and the power of ancient Rome themes feature in the work of designers, nuns, fascist supported schools and industry workrooms. A NDS work showing oblique reference to political events was created at a time when Mussolini proclaimed the birth of a new Roman Empire. It appears to reference the Italian conquest of Ethiopia in 1936 (also known as Abyssinia). It was made at Berlin's Verein für Deutsches Kunsthandwerk (Association for German Arts and Crafts) (Fig. 10).<sup>40</sup>

37 Doordan, "Political Things," 225.

38 Heffernan, "Stitch Kings," 97–120. Later, Henderson was the only non-Catholic to receive the highest papal honour award.

39 Doordan, "Political Things," 227.

40 Edinburgh College of Art, NDS 553. This work appears to be lost. The image is from a remaining photographic negative.

Later, newspaper articles in Scotland in 1948 and again in 1962, suggested the Italian fascist styled works were considered to be of a discomforting nature. These attitudes would have contributed to their exclusion from design history. The designers would have been exposed to fascist propaganda and embroidery training at school. The fascists committed to racial purity, the family, and tradition encouraged embroidery, even though it contradicted their drive for technology. The fascist women's organisation *Massaie Rurali* with a membership of over one and a half million women in the 1930s, offered embroidery training.<sup>41</sup> According to historians, the decorative design of fascist appearance is outside the confines of modernism.

### Communism, Nationalism and Industry in Hungary

In the 1930s, a different situation existed for embroiderers under Communist rule in Hungary. National independence and identity were strong motivating forces. In spite of powerful industrial progress folk culture was encouraged within national culture propaganda. Embroidery design was already influenced by migration and colonisation, commerce, travel and publications. However during the late 1920s and 1930s, Coats held classes for their mill girls, who learnt to make tablecloths and doilies. The dissemination of colonial design by Coats was seen as a threat, as recorded in 1934 by Máriska Undi:

This dangerous invasion of western decorative forms- with which came the influence of western architectural and decorative style- was propelled by western thread trade manufacturers, who wanted a better market for their productions and threatened to swamp the home style of decoration altogether.<sup>42</sup>

Undi was recognised as the leading embroidery designer in Hungary. Earlier she was an active member of the influential Gödöllő colony, a campaigner for dress reform, publisher of Secessionist designs and lecturer at Budapest School of Applied Arts. In 1932, she was commissioned by the German Ministerium für Cultus und Unterricht (Ministry of Education) to publish peasant designs from her ethnography collection. The booklet series was translated into English and published until 1945.

The influence of the Austrian, German, Italian and Hungarian women is evident in 1930s British designs, in particular works by leading artists Rebecca Crompton and Kathleen Mann. The interwar years were considered significant period of development in self-expression and spontaneity in

41 Perry Willson, *Peasant Women and Politics in Fascist Italy: The Massaie Rurali* (London, New York: Routledge, 2002), 126 and 129.

42 Maria Undi, *Kalotaszegi Irsasok Himzes* (Budapest: Ministerium für Cultus und Unterricht, 1934), 53.

British embroidery design.<sup>43</sup> The influence continued for many decades as the NDS works and publications circulation was extended in Britain and beyond.

## Conclusion

Women such as Zweybrück and Köhler made an important contribution to design education and led successful design careers during a period of political and cultural oppression. They skilfully developed a design relationship between visual style, political and social comment during a period of intense conflict and hardship. Their textiles were the embodiment of turbulent times. Restrictions on women and the applied arts by the Bauhaus helped to create dissenting, marginal, fragmentary design movements, as typified in these NDS embroideries. Abstract, geometric forms, primary coloured, produced by technology, with no figurative or symbolic elements are considered by many historians to characterise much design of the Modern Movement. Abstraction eliminated figurative, decorative and symbolic elements in favour of the manipulation of form, and rejected tradition and historicism as a source of a design. Figurative, decorative embellishment and the intrinsic pattern of textiles were at odds with both the functionalism and simplicity of modernism.

Suppressed at the time this style of design was subsequently overlooked by recent constructs of modernism. Paradoxically the spaces between art and industry merged. They challenged a widely held view of embroidery as an applied rather than expressive medium. These modern designs had an immediate and significant impact on British textile design.

An uneasy relationship existed between Coats' collecting and marketing. Coats' market forces played a role in shaping the production of the designs referencing political and social events or themes acceptable to the ruling political regimes. Complex and multiple strategies contributed to the creation and dissemination of these designs into British culture. However the skill and artistic talent of the women designers ensured the works were successful both as trade items and works of art. The support of publishers and artists such as Höch ensured the embroideries received significant visibility in their day, but the decorative appearance of their works excluded them from full modernist classification. It is readily apparent that these embroiderers achieved works of excellence in an alternative modernist style during the inter-war period.

## Acknowledgements

With gratitude to the archives, museums and universities who willingly allowed me access to their collections. With gratitude to Alison Coleman for providing the German translations in this research.

<sup>43</sup> Tanya Harrod, *The Crafts in Britain in the Twentieth Century* (London: Yale University Press, 1996).

## Sandra Heffernan

Massey University, New Zealand



Associate Professor Sandra Heffernan lectures and researches in textile design at Massey University. She enjoys the researching textile collections, finding forgotten documents and undertaking oral history interviews to reveal fascinating concealed histories. Innovative textile finishing processes are key to her design practice and postgraduate industry, science and enterprise collaborations feature strongly in her supervision portfolio.

E-mail: S.L.Heffernan@massey.ac.nz

## Women and Their Professional Activities in Architecture, France 1918–1945

In France, the feminisation of the profession started at the beginning of the seventies, but women architects started to practice architecture at the very beginning of the twentieth century.

Those pioneers, and especially women who practiced before 1945, were neither numerous among registered architects (subscribers at the *Ordre des Architectes*) nor among architects who realised planning permissions and were a few in professional societies as the *Société Centrale des Architectes* (SCA) or the *Société des Architectes Diplômés par le Gouvernement* (SADG). So it seems that women were not practicing project management a lot. Nevertheless, the large number of women who studied in architectural schools in France since the end of the nineteenth century, indicates that women wished to fit into this architectural environment.

To understand this situation, it is necessary to extend the research scope: women architects were practicing architecture 'differently'. Their practices were not regulated by the *Ordre*: town planning, journalism, landscape design... It seems that women participated in the diversification of architectural practices.

This research is an opportunity to take a fresh look at the profession of architecture. It is an opportunity to discover the real scale of women's activities.

Keywords: women pioneer, diversification, France, practices, deed of architecture

### Introduction<sup>1</sup>

Who were the French women designers and architects in the first half of the twentieth century?

If we were to believe what is commonly known, we would be tempted to think that until very recently French women architects were indeed very few! In fact if the names of some contemporary French women architects are now known, such as those of Françoise-Hélène Jourda (who died quite recently in May, 2015), Odile Decq, Manuelle Gautrand, Anne Demians, Anne Lacaton, in partnership with Jean-Philippe Vassal, the situation is quite different for architects of previous generations: at best only the names of Charlotte Perriand or Adrienne Gorska appear.

Thus the common perception is that women architects were indeed very few, and that they never played a major role in architecture.

But beyond these preconceptions what was the substance of their lives? What is the history of French women architects? And who were these women in the shadows?

Their story remains to be written.

As a matter of fact there exists, at the moment, no specific and comprehensive paper on the history of French women architects. Only a few documents have been real steps forward in our knowledge of the subject.

The research work initiated by Lydie Mouchel in 2000<sup>2</sup> has enabled us to get to know better what positions were occupied by women in such important schools of architecture as the *Ecole nationale supérieure des beaux-arts* (Ensba) and the *Ecole Spéciale d'Architecture* (ESA) in Paris in the 19th century.<sup>3</sup>

1 I will herewith present the results of a research work which I started within the framework of a master *Recherche en histoire culturelle et sociale* at the University of Versailles in 2009, and regularly kept working at ever since. It is the basis of a thesis I am now starting at the University of Strasbourg (September 24, 2015).

2 Lydie Mouchel, "Femmes architectes 'une histoire à écrire'", (DEA Histoire socio-culturelle, Ecole Nationale Supérieure d'Architecture de Versailles/Université Versailles-Saint-Quentin-en-Yvelines, 2000).

3 Lydie Mouchel's research allows one to discover the presence of women at the *Ecole nationale supérieure des beaux-arts* (Ensba) between 1898–1945 and their presence at the *Ecole Spéciale d'Architecture* (ESA) between 1880–1961.



Fig. 1. Miss Bocsanyi, one of the seven women architects who graduated from the Ecole des Beaux-Arts de Paris (photographer: Paul Darby). Courtesy of CNAM/SIAF/Cité de l'architecture et du patrimoine/Archives d'architecture du XXe siècle.



Fig. 2. One of the seven women architects who had graduated from the Ecole des Beaux-Arts de Paris, probably Mrs Fratacci (photographer: Walery). Courtesy of CNAM/SIAF/Cité de l'architecture et du patrimoine/Archives d'architecture du XXe siècle.



Fig. 3. Marion Tournon-Branly. Courtesy of Académie d'Architecture/Cité de l'architecture et du patrimoine/Archives d'architecture du XXe siècle.

The 2009/2010 number 15 issue of the EAV journal, brought out by the *Ecole nationale supérieure d'architecture de Versailles*, has published documents relating to the history of French women architects, such as a draft paper dated 1930, authored by a French architect, Emile Maigrot, about seven women architects who had graduated from the Ensba of Paris: Renée Bocsanyi, Agnès Chaussemiche, Yvonne Dupuy, Jeanne-Marie Fratacci, Jeanne Surugue, Marie Sapareva and Lucie Dumbrevano (Figs. 1 and 2).<sup>4</sup> The issue also contains a paper by Meredith Clausen about the Ensba in which she explores the reasons behind our ignorance of the history of French women architects, and surveys the first women admitted at the Ensba.

In 2012, the French journal *Criticat* also dedicated its number 10 issue to women architects, underlining and documenting the work of contemporary architects such as Carin Smuts and Paola Vigano. It also devoted some pages to more historically oriented studies about French pioneer women<sup>5</sup> such as the role played by Paulette Bernège, who worked towards the rationalisation of private spaces between the two World Wars.

4 Spelling of the name of this woman graduate is uncertain.

5 Stéphanie Mesnage, "Éloge de l'ombre," *Criticat* no.10 (2012), 40–53.

Finally, the *Dictionnaire Universel des Créatrices*, released in 2013 by *Editions des Femmes*,<sup>6</sup> is the most important contribution. Its aim is to try and 'identify creative women, whether known or unknown, who, individually or as a group, stood out in their time and opened new vistas in one of the manifold fields of human activity'.<sup>7</sup> Notes concerning architecture, urban planning and landscaping (section supervised by Ms Anne-Marie Châtelet) document the 'better known' French women architects, among whom are (for the period under consideration, namely 1918–1945): Jeanne Besson-Surugue, Renée Gailhoustet, Adrienne Gorska, Marion Tournon-Branly (Fig. 3) and Juliette Tréant-Mathé. But this publication also highlights others, recorded as 'lesser figures' in history, such as Geneviève Sée, as well as foreign women architects who worked in France at one time or another:

Apart from Eileen Gray, the dictionary features more modest, lesser known players in the field of architecture in France, such as Monica Brügger, Katarzyna Kobro, Blanche Lemco van Ginkel, Beate Schmitter, Anastasia Tzakou, Ingrid Wallberg and Myra Warhaftig. Finally, a summary note attempts a short synthesis of what is known about pioneer French women architects.<sup>8</sup>

Thus this story is still mostly unrecognized today.

### The Main Steps in the Feminisation of the Architectural Profession

In spite of the fragmentary nature of our knowledge, we can highlight some turning points.

At the end of the nineteenth century, women were among students who matriculated in architecture studios at the Ensba, then the preeminent centre of teaching for architecture in France, and in the

6 Béatrice Didier, Antoinette Fouque and Mireille Calle-Gruber (ed.), *Le dictionnaire universel des créatrices* (Paris: Edition Des femmes, 2013).

7 Didier, Fouque and Calle-Gruber (ed.), *Le dictionnaire universel des créatrices*.

8 Stéphanie Mesnage, "Architectes [France depuis le début du XXe siècle]: Les pionnières," in Béatrice Didier, Antoinette Fouque and Mireille Calle-Gruber (ed.), *Le dictionnaire universel des créatrices* (Paris: Edition Des femmes, 2013), 229–230.

classes of the ESA (Figs. 4 and 5). In 1898, Julia Morgan was the first woman to be admitted to Second Class,<sup>9</sup> the first level of study at the Ensba to be accessible after a competitive examination, and a first period of training in so-called 'external' or 'free' studios. This pioneer was an American, as was Laura White, who in 1883 entered the ESA.<sup>10</sup> The very first generation of pioneers (end of nineteenth century – 1918) was thus made up of a majority of foreigners, who, moreover, rapidly gained their diploma as qualified architects. Lydie Issacovitch who was born in Russia was the first woman to graduate in France in 1906 from the ESA.<sup>11</sup> But the first woman to graduate from the Ensba was French – Jeanne Besson-Surugue, in 1923.<sup>12</sup> With the passing of time the proportion of women in schools of architecture increased: about 50 women were admitted at ESA between 1918 and 1945, and 82 at the Ensba between 1918 and 1929.<sup>13</sup> Over the same period, some 70 women graduated from the École Centrale des arts et manufactures de Paris (ECP),<sup>14</sup> into which women had been welcomed since 1918 into its four sections, including the construction section. In the following period (1945–1961), admissions were much more numerous: 170 women got into ESA, a number which, however, must be put into perspective, considering the doubling of student enrolment in that school during the same period.

Sociologists who work on the issue of the feminisation of the architectural profession, such as Olivier Chadoin, Nathalie Lapeyre, and Nicolas Nogue, select the year 1968 for the identification of the true beginning of this process, or some thirty years after most other liberal professions.<sup>15</sup> This date corresponds to that of the splitting up of the training system at the Ensba, which gave birth to the Unités Pédagogiques d'Architecture (UPA), namely the institutions which opened more widely with the end of the *numerus clausus* (Admission Limits). This reform would prove to be beneficial for women. Between 1975 and 1985, the proportion of women among graduates increased from 11 % to 29 %; between 1985 and 1995, it soared to 40 %.

Thus women entered schools of architecture rather early, and have continued to grow in numbers ever since.

9 Mouchel, "Femmes architectes," 23.

10 Mouchel, "Femmes architectes," 24.

11 Archives ESA (registers). In the original presentation, I said that Adrienne Lacourière was the first woman to graduate in France (at the ESA in 1896); in later recherche I discovered that was a mistake.

12 Mouchel, "Femmes architectes," 26.

13 Calculations based on Lydie Mouchel's surveys (see Mouchel, "Femmes architectes").

14 Stéphanie Mesnage, "Actrices de l'architecture: Les femmes dans l'exercice professionnel architectural entre 1890 et 1968" (Master 2, Ecole Nationale Supérieure d'Architecture de Versailles/Université Versailles-Saint-Quentin-en-Yvelines, 2009), 107.

15 Nathalie Lapeyre, *Les professions face aux enjeux de la féminisation* (Toulouse: Octarès publ., 2006), 89.

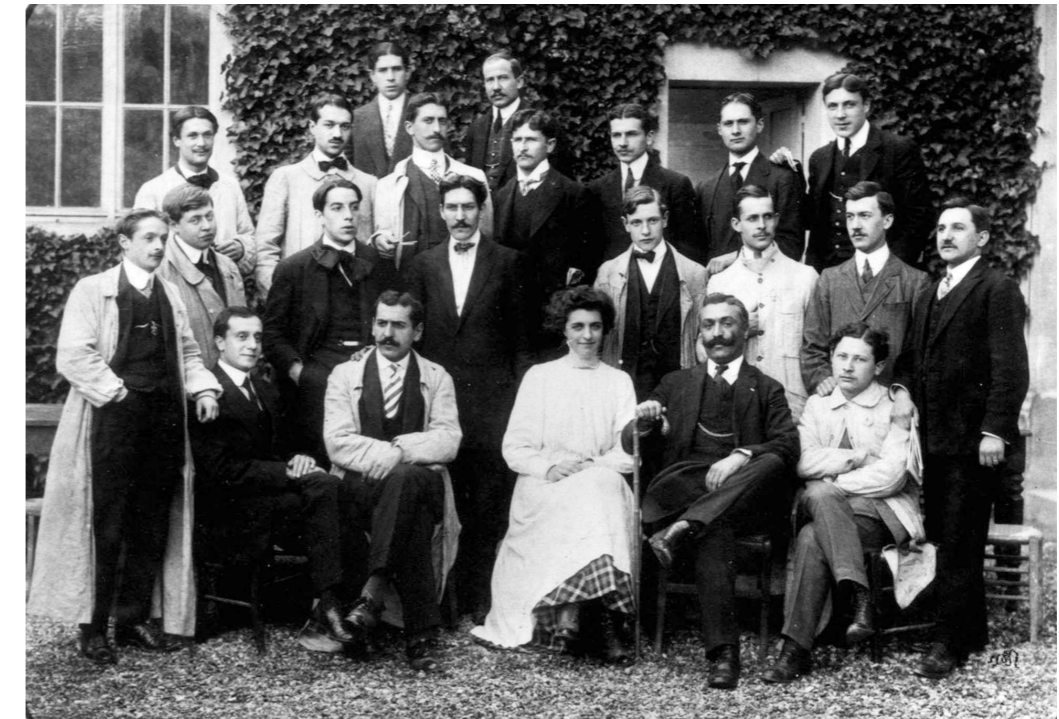

Fig. 4. ESA, 1908–09 (the woman is probably Verna Cook).  
Courtesy of ESA/SADESA.



Fig. 5. ESA, 1902–03 (the woman is probably Lydia Issacovitch).  
Courtesy of ESA/SADESA.

## How to Approach the History of Women Architects

### a) Women Architects, Project Managers

There remains a veritable mystery concerning these pioneers who ‘disappear’: Indeed, in spite of their important presence during their studies, very little is known about their careers and their achievements. And with good reason – there were few women project managers, and this being the most newsworthy practice, was also probably the only one to pave the way for public recognition.

Probing into the archives which document the history of project managers in Paris –such as directory names for architects as drawn up after building permissions (or construction licenses) in Paris, the official notice board (Paris District) of the General council of the Ordre des Architectes, professional directories like the Sageret, or architectural journals– one can already identify a little less than 10 women who seem to have been active as project managers (whether on their own or in partnership) in Paris between 1880 and 1945, whereas during the same period they had been at least about 160 students at Ensba, at the ESA and at the ECP!<sup>16</sup>

Who were they? We can mention a few figures who were already active in the 1930s: Adrienne Gorska, who worked for a long time with her husband, Pierre de Montaut, and Juliette Tréant-Mathé, who did the same with Gaston Tréant. Other lesser known names appear, such as Renée Bodecher (Bocsanyi), who from the early 1930s, and in partnership with other architects amongst whom her husband Henri Bodecher, designed many structures, including a group of buildings on the avenue Montaigne, on behalf of Lloyd France Vie (Figs. 6 and 7).<sup>17</sup> She was still active in the 1970s, thus spanning several generations.

It must be noted that these three women worked in partnership with their husbands.

Later, in the 1950s, a more numerous second generation appeared. We may cite Georgette Becker, Gilberte Cazes or Solange d’Herbez de la Tour. Georgette Becker worked, alongside Albert Laprade, on the development of Le Mans old town, and on the first part of the administrative centre in Lille. Gilberte Cazes worked with Jean Lecouteur on various projects (offices, school groups or homes) and Solange d’Herbez de la Tour worked along Pierre-Edouard Lambert and was mainly active in the context of reconstruction.

How can we explain this phenomenon, and what became of all the others – that is to say, of all the women who studied architecture, and who, one may suppose, moved in architectural circles?

I propose that this lack of appreciation of women’s work has much to do with how one defines the architectural profession and its practices. I will stop for a moment to consider the historical background of this definition.

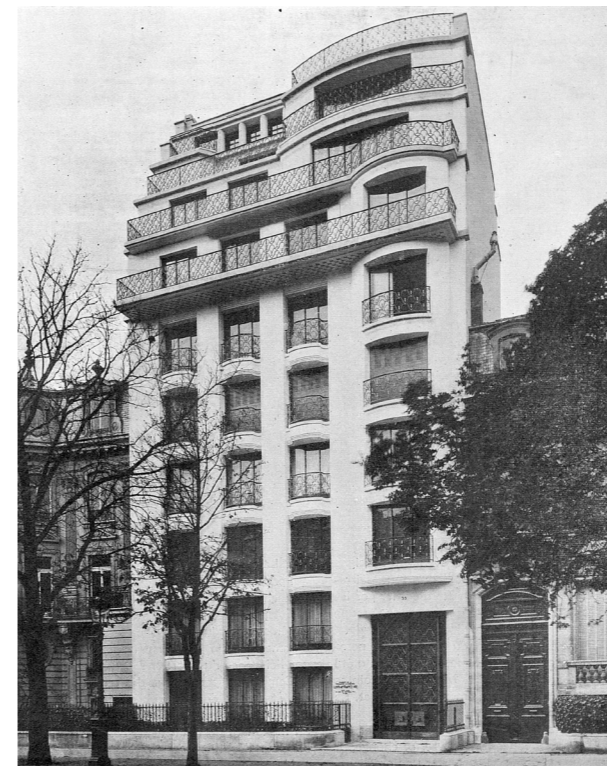

Fig 6. Henri and Renée Bodecher, Group of buildings, avenue Montaigne, Paris, on behalf of Lloyd France Vie (photographer: Chevojon). Published in *La Construction Moderne*, no. 27 (1936), 541.



Fig. 7. Henri and Renée Bodecher, Group of buildings, avenue Montaigne, Paris, on behalf of Lloyd France Vie (photographer: Chevojon). Published in *La Construction Moderne*, no. 27 (1936), 545.

The architectural profession is a very old one, but the modern notion dates back to the Renaissance. Until the nineteenth century, the architect was mainly an artist. With proximity to the *beaux-arts* (the liberal Arts) he also took on the identity of an intellectual, which differentiated him from manual workers who come under mechanical arts.<sup>18</sup> One of the imperative definitions was given by the *Dictionnaire de l’Académie*: ‘The architect is the artist who draws up buildings, determines their proportions, their layout, the decorations, has the plans carried into effect, assigns work to the staff and pays the bills’.<sup>19</sup>

In the nineteenth century, the advent of industrial society, the development of new techniques and the unprecedented growth of cities resulted in important changes in the architectural profession and its role: the architect was from then on less of an expert than an engineer, with his precise and

<sup>18</sup> Annie Jacques, *La Carrière de l’architecte au XIXe siècle* (Paris: Editions de la Réunion des Musées Nationaux, 1986), 4 ; R. Moulin et al., *Les architectes, métamorphose d’une profession libérale* (Paris: Calmann-Lévy, 1973), 14.

<sup>19</sup> *Dictionnaire de l’Académie Française* (7<sup>th</sup> edition, Paris: Institut de France, 1878), quoted by Annie Jacques, *La Carrière de l’architecte au XIXe siècle* (Paris: Editions de la Réunion des Musées Nationaux, 1986), 7.

<sup>16</sup> Personal calculations based on L. Mouchel’s research results (see Mouchel, “Femmes architectes”).

<sup>17</sup> Mesnage, “Actrices de l’architecture,” 84.

thorough knowledge he henceforth worked on wider questions of town planning.<sup>20</sup>

In this context many debates cropped up about the organisation of a profession to which access was free, without any need to produce one's diplomas or to prove one's ability.<sup>21</sup>

Indeed anybody could claim to be an 'architect' and have access to commissions without doing anything illegal. After 1880, in order to bear the professional title of architect, the only requirement was to pay a license, just as for commercial activities proper.<sup>22</sup>

One of the principal aims of architectural societies, notably of the Société Centrale des Architectes (SCA) and the Société des Architectes Diplômés par le Gouvernement (SADG),<sup>23</sup> was precisely to allow their members to 'be distinguished from the many "swindlers", contractors, surveyor clerks or site supervisors who took the title of architect' and to 'offer their clients a guarantee for competence and good repute'.<sup>24</sup> The architect's diploma had been in existence since 1868–1869 but it was at first perceived as redundant and few students sought it. In any case, it was not a prerequisite for practicing the profession and, therefore, did not as such stand for competence in the manner architects wished for.

It was only with the advent of the Vichy government that the debates initiated by professional associations on the architectural profession came to fruition, with the creation of the Ordre des Architectes (1940). Since then, the title of architect has only been conferred after registration on the official list of the Ordre, which initially depended upon various criteria, among which the possession of an architect's diploma.<sup>25</sup>

Thus, as recalled by this short historical review, architects never ceased to try and legitimate their activity in the face of neighboring professions. To that effect, they had long exercised control over the composition of their own professional corps. The aim of this control was notably to focus the profession upon its historic mission: architectural project management.

And this is one of the keys for the understanding of the history of women architects – it appears that women architects remained unknown because they were not project managers although they but practiced their profession in other ways.

20 Jacques, *La Carrière de l'architecte*, 8.

21 Catherine Jubelin-Boulmer, Françoise Hamon (ed.) and Dominique Hervier (ed.), *Hommes et métiers du bâtiment, 1860–1940* (Paris: Monum, éd. Du Patrimoine, 2001), 35.

22 Ibid.

23 *Société Centrale des Architectes* (SCA) established 1843, and *Société des Architectes Diplômés par le Gouvernement* (SADG) established 1877.

24 Marie-Jeanne Dumont, "La SADG. 1, 1877–1939: Histoire d'une société d'architectes," *Tribune d'histoire de l'architecture (France)* (1989), 6.

25 Gérard Ringon, *Histoire du métier d'architecte en France* (Paris: PUF, 1997), 97.

## b) Women Architects Elsewhere

We must indeed widen the field of research and reflection in order to discover the trace of women architects in their careers and to begin to understand how they infiltrated the profession.

The exploration of various sources already reveals the presence of women in a plurality of architectural practices which exist beside project management such as town planning, landscaping, writing, history, journalism, teaching, the protection of architectural heritage, to cite but a few.

In the period now of interest to us, namely before 1945, the selection as applied by the Ordre was not yet effective, but the profession was already focused on project management, and this had the effect of making other practices less visible.

Thus the study of the history of women architects becomes an invitation to take a different look at the profession and to take into account all kinds of practices which constitute veritable deeds of architecture, without limiting oneself to the definitions as given by organisms or institutions. We must now ask ourselves how to define a deed of architecture? Here architecture is more a question of practice than of official status.

Whatever the reasons, women seem to have been important players in the diversification of the architectural professions, thus anachronically designated - the phrase was used much later, in the 1980s, to speak of the widening of the architect's field of competence.<sup>26</sup>

The progress of this research does not yet allow us to yield a complete statistical analysis. But some practices and players have already been identified. In the field of town planning we can cite many women such as Jeanne Boulfroy, Denise Malette and Antoinette Prieur, who worked between the early 1940s and the late 1970s. Jeanne Boulfroy is the author of many urban developments, projects of urban planning and town plans in the French department of Charente Maritime. Denise Malette has designed various projects for urban development and reconstruction in the departments of the Ardennes or the Doubs. Finally, Antoinette Prieur has carried out similar assignments in the departments of Calvados and Loir-et-Cher.

In landscaping we see the name of Jeanne Besson-Surugue: Born in 1896 in Paris, she had studied at the Ensba in the Deglane/Maistrasse studio, and graduated as DPLG from the school in 1923. She was the first Ecole des Beaux-Arts woman graduate. She rapidly joined SADG (1924) and we know that her career was marked by two high points. First, she went to work in Cuba as a *fonctionnaire contractuel hors de France* (contract official for positions abroad), where she was in charge of plans for public parks, and she also had to supervise the works. It seems that she then worked

26 Robert Prost and Monique Minaca, *Prospective des métiers de l'architecture: Rapport final, Mission sur le bilan et la prospective des métiers de l'architecture* (Paris: Direction de l'Architecture et de l'Urbanisme, 1987) quoted by Rainier Hoddé, "Architectes hors l'architecture - Les métiers du 3e cercle," *Les cahiers de la recherche architecturale et urbaine* no. 2–3 (1999), 137.

alongside Jean-Claude-Nicolas Forestier, a famous French landscape architect. We know that she left Cuba in June 1933 for Indochina, where she joined the Public Works services, and became a Public Works architect in Phnom-Penh. The exact dates when she was nominated to these positions are not known, but something took her away from architecture. Contrary to other women architects, she was not surrounded by a triad of male architects; only her brother, Pierre-Hubert Surugue, was *Architecte DPLG*.<sup>27</sup>

In the field of journalism and architectural criticism, Simone Gille-Delaforon wrote many articles in several journals: *Arts*, and also *Beaux-Arts*, from 1935 to 1950, as well as in *La Construction Moderne*, where she gave various accounts of architects' projects, exhibitions, and congresses.<sup>28</sup>

In the fields of teaching and illustration, Juliette Billard (Fig. 8) is an interesting figure. born in 1890, accepted in Second Class at the Ensba in 1913, she began by working for other architects. She then worked as an illustrator, notably on the theme of architectural heritage for the City of Rouen. She also was a set decorator and model maker for the *Cinéromans* film studio. she finally taught drawing in a secondary school for girls in the city of Le Havre.<sup>29</sup>

Some women even simultaneously explored several types of practice, e.g. Geneviève Dreyfus-Sée (Fig. 9), who was a journalist, educationalist, historian and illustrator.



Fig. 8. Juliette Biard (Billard).  
Published on INA (Normandie Actualités/France 3 Haute Normandie/Diffusion 12/03/1965/Rouen: ORTF).



Fig. 9. Geneviève Dreyfus-Sée.  
Published in *Hommes et Techniques*, no 115–116 (1954), 559 (photographer: Weber).

### c) The Study of an Assemblage

I propose, therefore, that the history of women architects be written by considering in the widest possible manner the scope of the architect's domain of practice in order to bring to light all those who worked in the shadows, far from the kind of recognition which is awarded to project management.

But the identification of a number of practices, however wide in scope, would not suffice to answer the question: how did women architects exercise their profession?

In my view, to answer that question, one must adopt an attitude wherein one no longer aims to reveal forgotten figures or ways of exercising a profession. Rather one should study and understand the various practices of a whole professional population, in this case women architects who worked during the period 1890 to 1975 in the Île de France Region, in order to obtain a true and correct analysis.

Translated by Denis Griesmar

27 Mesnage, "Actrices de l'architecture," 62.

28 Mesnage, "Actrices de l'architecture," 84.

29 "Juliette Biard, première femme architecte," *Normandie Actualités* (programme broadcasted on March 12, 1965), <http://www.ina.fr/video/RCF07002127> (accessed August 1, 2015).

**Stéphanie Mesnage**  
**Strasbourg University**



Stéphanie Mesnage is a French architect. She graduated in 2010 with a Master's in Architecture from the Ensa'v (Ecole Nationale d'Architecture de Versailles) where she also obtained in 2010 a degree in history of architecture (Ensa'v/Université de Versailles-Saint-Quentin-en-Yvelines). She is working in architectural agencies (landscape architecture, architecture and urbanism) and is preparing a PhD dealing with professional activities of French women architects between 1880 and 1968 (Université de Strasbourg, EA 3400 ARCHE).

E-mail: [stephanie.mesnage@yahoo.fr](mailto:stephanie.mesnage@yahoo.fr)



## Women and Power in the History of Modern Architecture: The Case of the CIAM Women

In this article I will describe my research proposal to rewrite the history of the CIAM from a gender perspective. Despite the fact that the history of the CIAM has been written as a narrative of Great Male Architects, it was characterised by the performance of a group of strong, powerful women. The case of the CIAM is important in relation to the question of gendered power relations within professional networks and organisations. In fact, from a gender perspective the CIAM makes clear that these relationships are acted out on two levels. Firstly, there is the question of power as influence: how did these women, who often did not have a formal position as participants in the congress, succeed in obtaining influence? Besides formal power, informal power built upon relationships with people plays an important role here. Secondly, did these women use their influence to propose alternative plans? In other words, to what degree did these women identify with the modernist CIAM policies and to what degree did they have their own, autonomous, even subversive position. It is from this perspective that I will discuss the role of Charlotte Perriand (1903–1999) and Helena Syrkus (1900–1982).

Keywords: CIAM, networks, power relationships, historiography

In 2004 the American architectural historian Mary McLeod stated in an article that feminist architectural history had nearly disappeared.<sup>1</sup> The flood of interesting publications in this field had come to a halt and schools seemed to prefer classes in new themes such as sustainability, digitalisation and globalisation over gender and architecture. As one of the reasons for this setback McLeod states that the very success of gender studies in architecture may have contributed to its decline. Names of once-forgotten women have been resurrected, the reputation of architecture's male heroes has been taken down and discrimination in the profession has been exposed. If McLeod is right, why then still study the role of women in modern architecture? One reason may be present in the persistence of gender inequalities in the architectural profession. Another reason is that, contrary to what McLeod believed, women in architectural history still remain poorly studied. For example, many books have been written about the Austrian philosopher of science Otto Neurath, but who knows the story of his yearlong assistant, and later wife, Marie Reidemeister? Who knows the story of Stanisława Nowicka and Edith Schreiber who together with Charlotte Perriand worked at the atelier of Le Corbusier?

Three decades after the first pioneering activities of feminist scholars, it is still necessary to think of strategies to make visible the presence of women in architectural history. The history of the CIAM presents a clear example of a narrative that continues to be written from a male perspective and that, as a consequence, contains many female actors that remain until this day undetected. The aim of my research is to rewrite the history of the CIAM on the basis of gender balance: as a history in which both men and women are present. In addition, my research also challenges some of the orthodoxy surrounding feminism today. Therefore, I will start this article with a short excursion on gender studies and modern architecture, before moving on to the case of the CIAM women.

<sup>1</sup> Mary McLeod, "Perriand: Reflections of Feminism and Modern Architecture," *Harvard Design Magazine* no. 20 (2004), 64.

## Gender Studies and Architecture

For my research the difference between women's history as it emerged in the 1970s and contemporary gender studies is important. Today, gender studies has moved away from a narrow focus on emancipation and equal rights and starts with the recognition of 'gender' as a complex historical and social category. Also, this process happens in creative dialogue with other turns in historiography, such as the postcolonial turn, or the move towards global history. Therefore, it is important to reflect on feminist historical writing and to re-examine its methods and assumptions.

The development of women's history in architecture was closely connected to the so-called second feminist wave that began in the late 1960s. In fact, the earliest considerations of gender in architecture came as a result of the realisation of the exclusion of women architects from the discipline. A hallmark in this respect was the exhibition *Women in American Architecture* curated by the architect and scholar Susana Torre and held in the Brooklyn Museum in New York in 1977.<sup>2</sup> The exhibition was part of an inquiry from a feminist point of view of the conditions surrounding the production of space, and especially domestic space. Feminist researchers wanted to trace the extent of women's participation in that production as designers, theoreticians, or users. However, it was equally important to expose how the subordination of women was embodied in space and the complex role that architectural design played in that subordination. As a consequence, doing feminist research in the 1970s and 1980s meant a break with the dominant way of writing architectural history. It meant a break with the history that is focused exclusively on the figure of the architect and his work, or on movements and styles. Instead, feminist architectural history wanted to describe the social and cultural conditions of space production and the question, how women fit into the complex puzzle that ensured their invisibility.

Today, it is the question how we can move forward with the legacy of feminist research in mind. Feminism is ultimately about ending women's subordination, which in the past implied a harsh confrontation with male-designed institutions as well as well-defended patriarchal family structures. However, today we may raise the question, if this feminist ideology, with its emphasis on the struggle for equality and rights, did not also lead to a certain simplification. Perhaps today we need to take more distance from judgements of good and bad and reductive charges of sexism and victimization that seems to be implicit in feminist ideology.

To look at women's history beyond the dominance of feminist ideology means to cast a new focus on what it meant for women to have an unequal position in the century of equality. It means to ask the question after what enabled these women to find their way and to exercise influence. The history of the CIAM congresses provides a good example of how women were able to gain influential positions, while not being among the major protagonists in architecture and while not always being

<sup>2</sup> Susana Torre (ed.), *Women in American Architecture: A Historic and Contemporary Perspective* (New York: Whitney Library of Design, 1977).

visible. Therefore, the question that informs this research considers the strategies that women employed not so much to challenge male monopolies but to exercise influence within them.

In the following I will analyze two case studies that give an answer to the question: how did women within the CIAM from an unequal position succeed in exercising influence?

## Poland: Helena Syrkus

The first CIAM congress organized in Switzerland in 1928 resembled an exclusive gentle men's club, with architects like Hans Schmidt from Switzerland, Ernst May from Germany and Mart Stam from the Netherlands attending. There were however, also two women present, although far less visible: one was H el ene de Mandrot, who played a crucial role in the foundation of the CIAM and the other woman was Molly Weber, a female architect from Hannover (Fig. 1).

At the time of this first CIAM meeting, Poland was not yet present. However, two weeks after the meeting the Polish architect Symon Syrkus received a letter from the secretary of the newly founded CIAM, in which he invited him to become delegate for Poland for the CIRPAC, which was the executive committee of the CIAM.<sup>3</sup> At that time both Simon and Helena Syrkus belonged to Poland's most prominent avant-garde architects. At the end of the 1920s they faced a substantial task: not only were they involved in the reconstruction of the country after its destruction by the Great War, but they were also engaged in giving the country a new identity after its independence as a nation state in 1918. Like most Polish progressive architects, Simon and Helena Syrkus entertained close relationships with international avant-garde movements. Simon Syrkus had received a substantial part of his training abroad; he had studied architecture in Vienna, Graz, Riga and Moscow and in the early 1920s he had spent a couple of years in Berlin, Weimar and Paris where he became acquainted with the work of C ezanne, De Stijl and the Cubists. Helena was a well-known figure in Warsaw avant-garde circles; she too had an international focus and her



Fig. 1. Group photograph, First CIAM Congress, La Sarraz, Switzerland, 1928. Published in Mumford, *The CIAM Discourse on Urbanism, 1928–1960* ( Gta Archiv/ETH Z urich).

<sup>3</sup> Olgierd Czerner and Hieronim Listowski (eds.), *The Polish Avant-Garde, Architecture and Town Planning, 1918–1919* (Paris: Editions du Moniteur; Warsaw: Interpress, 1981), 83.



Fig. 2. Helena Syrkus sitting in between Giedion (standing on the left) and Le Corbusier (sitting on the right), CIAM IV, 1933. Courtesy of Gta Archiv/ETH Zürich (Nachlass Karl Hubacher).

knowledge of languages enabled her to translate foreign avant-garde literature into Polish. It is no surprise then that both Simon and Helena Syrkus were convinced of the necessity to found a Polish avant-garde journal as a vehicle for the diffusion of new ideas. Both were founding members of the journal *Blok* ('Block') followed in 1924 by the journal *Preasens* (latin for 'present').

Although both Helena and Simon Syrkus were active in international avant-garde movements, the CIAM invitation was addressed solely to Simon. The direct occasion to invite him was his participation in the competition for the Palace of the League of Nations organized in Geneva in 1927. Against the background of Le Corbusier's frustration with the outcomes of this competition –the outspoken modernism of Le Corbusier's project was rejected in favour of a more traditional design– Simon Syrkus' project was judged to be in the right camp

so to speak: it was a design that attracted the admiration of Le Corbusier.<sup>4</sup>

In a self-evident way, Helena Syrkus seems to have followed in the wake of her husband, so that at the time of the first conference of CIRPAC delegates in Basel in 1929 Simon appeared with his working partner and together they presented a plan for a worker's settlement.<sup>5</sup> In this way, as the essential other half, Helena obtained her entry-ticket into the CIAM. However, while at first she was very much part of the 'Syrkus couple' and in a way stood in the shadow of her husband, from the 1930s onwards she was more or less emancipated within the CIAM and increasingly accepted roles and responsibilities independently from him. Thus she was able to obtain an influential position within the CIAM. She was a member from 1928–57, vice-chairwoman 1945–54 and the co-editor of the *Charte d'Athènes*. She entertained personal friendships with Le Corbusier and Walter Gropius (Fig.2). She saw herself as the chronicler of the CIAM and was interested to research its intellectual and ideological underpinnings. To understand how Helena could obtain such a central position, there are two factors which need to be considered: firstly, her biography and secondly, the specific character of the Polish group within the CIAM.

4 Eric Paul Mumford, *The CIAM discourse on Urbanism, 1928–1960* (Cambridge Mass.: The MIT Press, 2000), 27.

5 Czerner, Listowski, *The Polish Avant-Garde*, 84.

Helena Syrkus was born Helena Eliasberg in 1900. She studied architecture at Warsaw's Technical Academy but she also took drawing lessons and she studied philosophy at the University of Warsaw, in addition to languages.<sup>6</sup> So, Helena was many-sided in her range of interests and competences and this defined her professional career. Even if both Simon and Helena had a keen interest in theory, Simon was more of a prototypical architect, intent on creating a built oeuvre. Helena, on the other hand, seemed to be able to translate her passion for architecture into a wide range of activities. As a couple, both Simon and Helena were convinced of the value of modern architecture for society. Modern architecture was for them the synthesis of the arts, aiming to create a new space and a new aesthetic for the New Man. The formulation of this doctrine also meant that architecture was for them a matter of teamwork in which the collective was more important than the individual contribution. This was the modernist paradigm of universality, in which each person was perceived in the abstract, stripped of gender identity. Thus Helena declared that she was no feminist, because architecture was teamwork in which the gender of each participant was not relevant.<sup>7</sup> However, even if this was their ambition, the reality was that within these teams men were often seen as protagonists while women mostly disappeared into the margins. Helena also had a marginal position but she was still able to exert a considerable influence. This was first of all due to her unconditional belief in Modernism and her support the ideas of both Le Corbusier and Gropius. However, in a more pragmatic way it was equally important that she could make herself 'useful' in various ways. It was the variety of her talents that enabled her to do such essential work as the writing of reports of the discussions held during CIAM meetings, act as interpreter, translate and edit texts. Those were all assisting activities in a way but they also put her in a position where she could exert influence.<sup>8</sup>

However, Helena's role within the CIAM would have been inconceivable without the special position that Poland enjoyed in the network. Within the CIAM, Poland was considered a special case and a fertile ground, because as a new nation state it was in a sense a tabula rasa in which the theory elaborated in the West could be practically applied. Where matters in the West were already fixated and defined, Poland seemed to offer opportunities to realise planning ideas.<sup>9</sup> However, this in no way meant that Poland faced a smooth process of growing into a nation state. In fact, besides the challenge of forging a population with different ethnic origins into a coherent national community, the country also faced substantial economic and social problems due to backwardness in many regions. At the end of the 1920s, the capital city of Warsaw alone was one of the most densely

6 Czerner, Listowski, *The Polish Avant-Garde*, 283.

7 Maria Lésniakowska, "Simon and Helena Syrkus, Biography," *Culture Place* (2015), <http://culture.pl/en/artist/szymon-and-helena-syrkus> (accessed December 23, 2015).

8 Lésniakowska, "Simon and Helena Syrkus"; Mumford, *The CIAM Discourse*.

9 Martin Kohlrausch, "'Houses of Glass': Modern Architecture and the Idea of Community in Poland, 1925–1944," in Rajesh Heynickx and Tom Avermaete (eds.), *Making a New World: Architecture and Communities in Interwar Europe* (Leuven: Leuven University Press, 2012), 93–105.

and highly populated cities of Europe with more than 2000 inhabitants per hectare in its central districts; also, it was the result of unplanned and uncontrolled growth. In this situation, in which the pressure to solve urban problems was very high, the CIAM became a platform of great importance to Polish architects. The ideas and proposals put forward during the CIAM meetings were of great interest to them as the incentive to opt for new solutions was exceptionally strong. In return, Polish architects gained a certain prestige within the CIAM for their dynamic and intense participation in debates. Also, the radical functionalist plan for Warsaw presented by Simon Syrkus during the IV (fourth) CIAM meeting met with approval and admiration within CIAM circles. For Le Corbusier, it meant a new step in the development of large scale planning methods.<sup>10</sup> The prestige of Poland as an active, militant and open-minded group was an important element that contributed to the rise of Helena within the CIAM.

### France: Charlotte Perriand

The designer Charlotte Perriand represents a different type of female protagonist within the CIAM. Where Helena Syrkus was part of a couple, Perriand was an autonomous designer who worked for Le Corbusier: where Helena's passion for modern architecture was mixed with a talent for writing and networking, Perriand was mainly a designer who established a reputation on the basis of her creative work. Perriand's design career was intertwined with the figure of the so-called 'New Woman' who after the First World War gained opportunities that were hitherto unheard of.<sup>11</sup> In general, for French women, the Great War was a turning point, with huge numbers of women entering the workforce, often in non-traditional jobs.<sup>12</sup> During the first part of her career Perriand's interest in innovative design coincided with the daring and independent lifestyle of a New Woman. In the spring of 1927, it was her bravado which led her to go to the studio of Le Corbusier to ask for a job. She was by then a 24-year old art school graduate who was bored by the traditional Beaux-Arts designs around her. At that time, Le Corbusier's office was still small, consisting only of Le Corbusier, his partner, Pierre Jeanneret, and the Swiss architect, Alfred Roth. Le Corbusier's employment of Perriand was not without ambivalence. In fact, Le Corbusier was vocal on the issue of women entering the profession of interior design. In the journal *L'Esprit Nouveau*, for example, he criticized women for their 'nineteenth century' taste in design and for their 'lack of an overall sense of order'.<sup>13</sup> However,

<sup>10</sup> Czerner Listowski, *The Polish Avant-Garde*, 49–53.

<sup>11</sup> Mary McLeod, "New Designs for Living, Domestic Equipment of Charlotte Perriand, Le Corbusier, and Pierre Jeanneret, 1928–29," in Mary McLeod (ed.) *Charlotte Perriand: An Art of Living* (New York: H.N. Abrams in association with the Architectural League of New York, 2003), 59.

<sup>12</sup> Mary McLeod, "New Designs for Living," 11.

<sup>13</sup> Le Corbusier, *L'Art Décoratif d'aujourd'hui* (Paris: Crès, 1925), 136–37, now in Mary McLeod, "New Designs for Living," 37.

after he had seen Perriand's design of the so-called 'Bar in the Attic' which was exhibited at the 1927 *Salon d'Automne*, he realized that she could provide a substantial contribution to his studio (Fig. 3). What also played a role in this decision was his difficulty in designing a convincing interior. While designers like Breuer and Stam developed the Wassily chair and the cantilevered side chair, and while a company called 'Standard-Möbel' was created in Germany, Le Corbusier still furnished his villas with either Thonet bentwood chairs or with furniture that looked as if it was serially produced but was actually hand made.<sup>14</sup> Also, in the exhibition for the *Weissenhof Siedlung* Le Corbusier had trouble completing the furniture for his houses.<sup>15</sup> He realised that to remain credible in his interior designs he needed an expert. With the help of Perriand, Le Corbusier gained a deeper understanding of, for example, the kitchen, the bathroom and of domestic life in general. He was now able to present innovative furniture, such as the tubular-steel chair. Le Corbusier's busy agenda – Perriand arrived at the studio at a moment when Le Corbusier's practice grew and when he became increasingly involved in competitions and urban issues – guaranteed that Perriand had considerable freedom in shaping interior designs; this also goes for her activities in the CIAM. It is telling that, despite their differences of opinion about modern life and modern interiors, these issues would never constitute a final ground to part ways. Politics did, however.

Perriand's introduction to the world of architecture coincided largely with her ten year-long collaboration with Le Corbusier and Pierre Jeanneret. However, she was not present during the first three CIAM congresses. In her autobiography, which was published one year before her death in 1998, Perriand gives as a reason for this absence that she was 'not yet ready, as I well knew', indicating the formative value that working for Le Corbusier had for her.<sup>16</sup> During the second congress held in 1929



Fig. 3. Charlotte Perriand, Bar in the Attic, Salon d'Automne, 1927. Published in McLeod, *Charlotte Perriand* (©Artists Rights Society).

<sup>14</sup> Mary McLeod, "New Designs for Living," 37.

<sup>15</sup> Ibid.

<sup>16</sup> Charlotte Perriand, *Charlotte Perriand: A life of Creation: An Autobiography* (New York: The Monacelli Press, 1998), 55.



Fig. 4. Charlotte Perriand, Le Corbusier, Small bedroom of Equipment for a dwelling as an example of the 14 square meter cell, published in 1931 by Le Corbusier in the journal *Plan*. Published in McLeod, *Charlotte Perriand* (©Artists Rights Society).

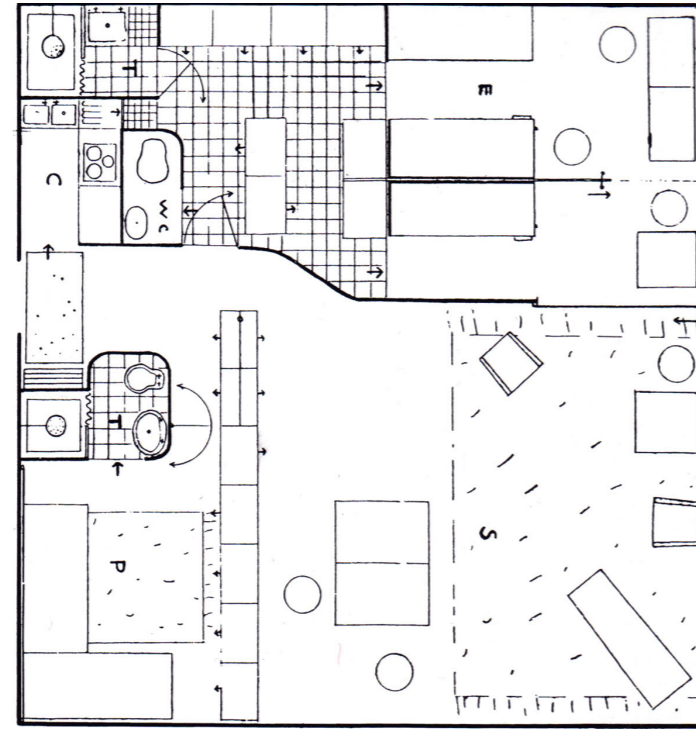

Fig. 5. Charlotte Perriand, Le Corbusier, Jeanneret, Apartment for a couple with three, four, five, six children (as part of the plans for Radiant City), 1930. Published in McLeod, *Charlotte Perriand* (©Artists Rights Society).

in Frankfurt she did contribute in an indirect way through her work in Le Corbusier's atelier. In line with the theme of this congress: 'Minimal Dwelling', Perriand went through great pains to think of a suitable interior design for a family with children who had to live in a very small home (Figs. 4 and 5).

The French CIAM group was highly international –reflecting the multicultural metropolis that Paris was at the time– but also slightly chaotic and tainted by internal dissent.<sup>17</sup> The French architectural avant-garde at this time was highly organized but at the same time not a unified front. The first French CIAM group largely coincided with another group of progressive architects: the Union des Architectes Modernes de France. Both groups only had male members: architects like Willy Boesiger, Philippe Jourdain and Pierre Jeanneret were members. It was only after the first group had dispersed that

<sup>17</sup> Evelien van Es et al. (eds.), *Atlas of the Functional City: CIAM 4 and Comparative Urban Analysis* (Bussum: Toth Publishers; Zürich: GTA Verlag, 2014), 148–161.

new recruits, including Perriand, received their chance within the CIAM; this was in the year 1933.<sup>18</sup> Perriand was recruited together with other colleagues from Le Corbusier's studio who, together with architects like Bossu and Nietzsche, had to keep the group running. Le Corbusier himself had little time to engage in CIAM affairs. He was concerned mainly with its general supervision and direction. The organisation of CIAM Five, dedicated to the theme of *Logis et Loisirs*, was one of Perriand's main tasks (Fig. 6).<sup>19</sup>

As part of the preparations of CIAM Five, Perriand was present as a member of the French group at the CIRPAC meeting held September 1936 at the castle of La Sarraz. During this meeting, it was discussed that the French and Catalan group would prepare a publication based on the outcomes of CIAM Four and aimed at a wide audience. Also, a provisional program was discussed containing, among others, Stam's functional city analysis of Berlin.<sup>20</sup> However, in January 1937 Le Corbu, Jeanneret, Perriand, Sert and Weismann decided to abandon, without consulting the other CIAM members, the decisions of the 1936 La Sarraz meeting, in favour of a theme which they considered to be more urgent: that of the dwelling. Inseparably linked to this concept was, according to them, the theme of 'leisure'.<sup>21</sup> This high-handed decision of the French group should also be seen in the context of the difficult political situation in Europe around that time. By the middle of the 1930s, Hitler was gaining territory in Germany and Mussolini felt secure enough to invade Ethiopia. In reaction to these developments, the French Communist Party agreed to form a coalition with other leftist parties, called the Popular Front. This strategy was extremely successful: the leader of the Popular Front, Léon Blum, was elected Prime Minister in June 1936. Against this background, the preparations for CIAM Five, which was to be held in Paris in 1937, were strongly politicized. As Mumford claims, around this time Le Corbusier began to use the CIAM



Fig. 6. Charlotte Perriand, with Grete Hubacher and Sert, CIAM IV, 1933. Courtesy of Gta Archive/ETH Zürich (Nachlass Karl Hubacher)

<sup>18</sup> Enrico Chapel, "France – From Paris to Athens," in: Van Es, *Atlas of the Functional City*, 148.

<sup>19</sup> There is very little reception of the activities of Perriand in the CIAM by critics. In general, the designs of Perriand received wide coverage in the press. However, most critics discussed the objects designed by her – furniture for example or apartment plans. This often occurred on occasion of an exhibition in which she participated, such as the Salon des Artistes Décorateurs of 1928. However, her organisational activities within the CIAM were rarely a theme for critics. See: Mary McLeod, *Charlotte Perriand*, 62–65.

<sup>20</sup> Mumford, *The CIAM Discourse*, 105.

<sup>21</sup> Mumford, *The CIAM Discourse*, 110.

and the upcoming congress to convince the French left wing of his sympathy for the Communist Party: he wanted the support of the Popular Front government for his proposals on among others agrarian reform.<sup>22</sup> In this way, the fifth CIAM congress, which was held at the end of June 1937 in Paris, did not continue earlier CIAM approaches that had emphasized analytical rigor and scientific inevitability - see for example the 'Functional City' exhibition organized in Amsterdam in 1935. Instead, a theme was chosen that was in line with the policies and ideals of the Popular Front: what was now at stake was city planning as the blueprint for a balanced society.<sup>23</sup> A more broad-based appeal to the masses was made, and leisure-time possibilities were perceived as an integral part of these needs. Concretely, the program of CIAM Five consisted of a large number of speakers: three main talks and an extensive number of 'interventions and communications.' Perriand was involved in the organisation of these talks.<sup>24</sup> The end of CIAM Five coincided with the inauguration of the *Pavillon des Temps Nouveaux* in July 1937. It was Perriand's task to design the interior decoration of the Pavillon, which consisted of a blue, white and red canvas tent, with an interior steel framework and adorned with political slogans and photomontage murals. It was also Perriand's task to design its exhibition, dedicated to the ideas of the CIAM.<sup>25</sup>

During the first years of her CIAM activities, Perriand was still fully loyal to Le Corbusier. In 1934, for example, Perriand took the initiative to write a letter to the French CIAM group in which she complained about her colleague André Lurçat, who was also a French CIAM member. During a Soviet conference on Western Architecture organized in January 1934, Lurçat had denounced Le Corbusier as a capitalist architect, perhaps even a fascist. Perriand was worried that Lurçat's statements would threaten the unity of the French group.<sup>26</sup> Later on, the unity was indeed broken, with Perriand choosing the side of Lurçat and the revolutionaries.

The middle of the 1930s signalled the years when Perriand was most active for the CIAM however, during these years she also gradually distanced herself from Le Corbusier. This departure should be seen against the background of her growing interest in both leftist politics and social issues.<sup>27</sup> Perriand started to attend Communist meetings and became engaged in left-wing cultural events. Whereas her taste in design had been up to that point rather luxurious and elitist, she now changed to a more egalitarian and populist style. Up to 1934, Perriand's agenda was still on a par with that of Le Corbusier who himself had become increasingly involved with social and political issues,

22 Mumford, *The CIAM Discourse*, 103.

23 Mumford, *The CIAM Discourse*, 110.

24 Ibid.

25 It was, as Mumford, states, a 'low-budget shrine to the CIAM...' presenting what was labelled as the CIAM-CIRPAC 'Resolutions of the Athens Congress' of 1933. Mumford, *The CIAM Discourse*, 115.

26 Mumford, *The CIAM Discourse*, 93.

27 Danilo Udovicki-Selb, "'C'était dans l'air du temps', Charlotte Perriand and the Popular Front," in McLeod (ed.), *Charlotte Perriand*, 69–89.

embracing a small nonconformist movement called Regional Syndicalism.<sup>28</sup> However, increasingly Perriand's commitment to reform extended beyond Le Corbusier's political position. She produced independent designs with the goal of awakening both her colleagues and the public to urban poverty and suffering. Perriand also started to write Marxist articles; in January 1935, for example, she wrote a Marxist critique of current dwelling for the magazine *L'Architecture d'Aujourd'hui*.<sup>29</sup>

The years leading to the fifth CIAM congress in 1937 saw a deepening of the conflict between Le Corbusier and the younger, Marxist inspired generation. Illustrative of the widening gap between Le Corbusier and Charlotte Perriand was a conflict about the *Pavillon des Temps Nouveaux* exposed at the *Exposition Internationale des Arts et des Techniques dans la Vie Moderne* which was organised in the same year as CIAM Five, in 1937.<sup>30</sup> In 1934, Le Corbusier decided the French CIAM group would also participate in the international exposition. Perriand became responsible for the organisation of a collective show of the CIAM group. Inspired by her left-wing commitment, Perriand suggested to Le Corbusier to bring a group of young Communist designers into the show. Le Corbusier did not have any interest in the ideas of this group but he did see it as a chance to gain the sympathy of the left-wing intelligentsia. It was also a source of free labour to him. Le Corbusier promised the young designers they would be full members in the 'collective' CIAM project and that they would receive a normal salary. However, the designers never received any money or the opportunity to do interesting work. They had been just free labour force. Perriand was outraged with this situation. The gap between her political idealism and Le Corbusier's opportunistic behaviour had become too wide. Perriand decided to quit both Le Corbusier's atelier and the unfinished pavilion. The CIAM history at this point also came to an end for her.

In this way, Perriand had been a member of the French CIAM for a relatively short period, from 1933–1937. Still, she did succeed in exercising a certain influence. During the Frankfurt congress she played an important role in changing the scope of Le Corbusier's designs from a clientele that was well-to-do to a clientele of modest means. She designed the small bedroom of the Equipment for a Dwelling which Le Corbusier presented at the 1930 CIAM meeting in Brussels to illustrate a 14-square-meter unit. She also designed the apartment plans based on that unit and made for bachelors and families with three, four, five and six children, later published in the journal *Plan* (Figs. 4 and 5).<sup>31</sup> In the second place, Perriand played a role in raising the political awareness within the CIAM. Up to the 1930s, the CIAM had always regarded itself as linked in a somewhat loose way to

28 Joan Ockman, "Lessons from the Objects: Perriand from the Pioneer Years to the 'Epoch of Realities,'" in McLeod, *Charlotte Perriand*, 162.

29 Udovicki-Selb, "'C'était dans l'air du temps,'" 81; McLeod, "Charlotte Perriand's *Art de vivre*," 14.

30 Udovicki-Selb, "'C'était dans l'air du temps,'" 75–76; Van Es, *Atlas of the Functional City*, 160.

31 The small bedroom was part of the model apartment shown at the *Salon d'Automne* of 1929. This was a large apartment for the middle class. In his paper for the 1929 Frankfurt CIAM congress, Le Corbusier used the small bedroom of this apartment as an illustration of his residential cells of 14 square meters. See: McLeod, "New Designs for Living," 64.

the collectivist politics of the left. However, in the 1930s, Perriand reminded the CIAM members of the need to choose sides, rather than rendering oneself available to each power that was willing to modernise. Her clash with Le Corbusier can, in this way, also be regarded as illustrative of a wider discussion within the CIAM.

## Conclusion

So, how did Syrkus and Perriand succeed in gaining influence in the CIAM? Firstly, what was important was their association with an established, influential male architect. This literally opened doors for them. Secondly, both Syrkus and Perriand were, at the time of their CIAM participation, passionate Modernists. They considered themselves part of the cultural avant-garde and did not contend with society's conventions. Within the CIAM, Helena Syrkus had the possibility to grow into an autonomous role, based on her non-architectural qualities. Syrkus displayed intellectual qualities and was interested in the ideology of the Modern Movement. For Perriand the situation was different: as a designer working for Le Corbusier, loyalty to the boss always played a role. However, even in this limited space, Perriand succeeded in leaving a mark.

## Rixt Hoekstra

Goethe University, Frankfurt am Main

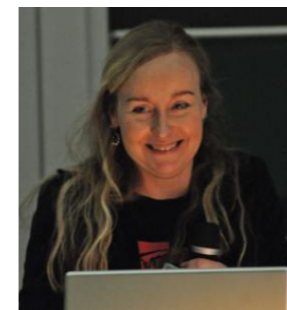

I work as Program Manager Research at the Design Academy in Eindhoven. I finished my dissertation on Tafuri called 'Building versus Bildung, Manfredo Tafuri and the construction of a historical discipline' in 2006. I specialise in the fields of modern architectural theory, historiography, and the development of architectural discourse in the twentieth century. In the past years, I have published, among others, about the influence of poststructuralism in the work of Dutch architect-intellectuals for the journal of *Archimera: Architektur. Kultur. Kontext* (2013) and about the development of architectural discourse in the Communist GDR, published in *The Journal of History & Theory of Architecture* (2014). In addition, I have published about the possibility of (architectural) critique in a neoliberal society, amongst others, in the book *Is there (Anti) Neoliberal Architecture?* (Berlin, 2013). Also, I was one of the editors of the book *The Death and Life of the Total Work of Art* (Berlin, 2015) which is the conference paper of the 12th International Bauhaus Kolloquium held in 2013 in Weimar. This paper is part of my Habilitation on the role of female actors in the CIAM.

E-mail: [Titiarixt.hoekstra@gmail.com](mailto:Titiarixt.hoekstra@gmail.com)

## Planning Education by Post: Jaqueline Tyrwhitt's War Correspondence Course

This paper constitutes part of a larger research project the author carried about the life and career of the English town planner, editor and educator Jaqueline Tyrwhitt. The paper will investigate her contribution as director at the School of Planning and Regional Reconstruction in London and the war correspondence course she organized. During the Second World War, in 1942, Jaqueline Tyrwhitt was invited to replace the director E. A. A. Rowse, during his service in the army. On that occasion she started to direct a war correspondence course for people who were serving in the Allied Forces; the double aims of the course were to invite people to take part in the reconstruction process after the end of the war and to educate planners and officers for the application of the New Town Act. The school was recognised as an institution and the course enabled graduates to register as a member of the Town Planning Institute. The lessons were of a multidisciplinary nature, from economy to geography, architecture to law, and sociology to rural studies. The model of the war correspondence course was unique and original in its purpose and its goals, and enabled hundreds of professional to take part to the post-war reconstruction.

Keywords: planning, school, interdisciplinary, reconstruction, practice, team work

During the Second World War the exceptional conditions of the conflict gave opportunities to women in several fields to challenge themselves in tasks normally undertaken by men. It was thanks to the opportunity to replace a man during the war that the English town planner, educator and editor, Mary Jaqueline Tyrwhitt, started her career. Called Jacky by friends and colleagues, she was born in South Africa in 1905, and spent her life across London, Toronto, Cambridge in the US, and Athens, where she died in 1983. It's impossible to bestow a single definition on Jaqueline Tyrwhitt: during her life she worked as town planner, educator, coordinator, editor, secretary, curator, translator, and more. It's not possible, either, to link her to a specific group. During her life she joined numerous national and international organisations and she also contributed to the foundation of institutions and forums of a global scale. The most relevant and famous institutions she worked for are the British Ministry of Information, the United Nations and the Graduate School of Design at the Harvard University. She helped and supported renowned scholars during her life, such as Sigfried Giedion, Josè Luis Sert and Constantinos Doxiadis, even though her name has rarely emerged in association with any one of them, except in very recent times.<sup>1</sup> After her death in 1983, in fact, no research was undertaken about the life and career of Jaqueline Tyrwhitt for nearly 20 years, until Professor Ellen Shoshkes from the Portland University and a few other scholars started to explore the subject. In particular, a fundamental contribution on the subject of this paper has been produced by the Professor Ines Zalduendo from the Graduate School of Design.<sup>2</sup>

During her education Jaqueline studied at the Royal Horticulture Society, in London, where she obtained her diploma in horticulture in 1924. After studying at the Architectural Association, and at the London School of Economics until 1927, she moved to Germany to follow a Town Planning course, particularly Land Settlement, at the Technische Hochschule, Berlin University, in 1937. Due to the political situation in Germany, after a year she had to return to England, where she obtained an honour diploma at the School of Planning and Regional Reconstruction Development.

- 1 Ellen Shoshkes, *Jaqueline Tyrwhitt: A Transnational Life in Urban Planning and Design* (Burlington, USA: Ashgate, 2013).
- 2 Inès Zalduendo, "Jaqueline Tyrwhitt's Correspondence Courses: Town Planning in the Trenches" (paper presented at Harvard University Graduate School of Design Special Collections, April 2005), 1–11.

This paper will present the very start of Tyrwhitt's career in educational institutions. This represented the first episode of a lifelong series of occasions for Jaqueline to be involved in institutional reforms, editorial projects, and in the evolution of the town planning and architecture disciplines. The experience illustrated below was a fundamental training experience for Jaqueline herself and not just for her students: some of the principles introduced in the war correspondence course had been then implemented in the construction of the new faculty of Urban Design, inaugurated with Jose Luis Sert in 1959. The context where Jaqueline had the first opportunity to enter the educational system was the School of Planning and Regional Reconstruction (SPRR), founded in 1935 originally as a post-graduate extension of the Architectural Association. The School became an independent association in 1940 due to financial problems and internal politics. Although the level of its courses was recognised by the Town Planning Institute, the new SPRR had to be financially self-sustained with annual subscriptions from individuals and grants from professional and learned societies. In 1941 the SPRR, where Jaqueline had obtained a diploma years earlier, called her to temporarily replace E.A.A. Rowse, who had to leave for military service. Without any previous experience in education, Jaqueline became Director of the SPRR from 1941 to 1948. She supervised a small team with whom she proposed a new agenda for the Association, including education and research projects. For the research department she coordinated the production of a series of maps of Britain with the geographer Eva Taylor, experimenting with new standards of graphic representation to describe a territory in all its complexity, including physical, social and economic features. During the same period the War Office commissioned the education department at the SPRR to prepare 'the official Army Education correspondence course in Town and Country Planning'.<sup>3</sup> Jaqueline accepted the commission and organised three courses for architects and planners who were serving with the Allied Armed Forces. The courses involved over 2000 people altogether, including members of the armed forces of the United Nations.

The war correspondence course offered three independent courses, depending on the background of the students enrolled: one was reserved for people who had already passed the final examination as architects, surveyors or engineers the second was dedicated to professionals in the allied branches of planning that could, on obtaining the diploma, apply for an intermediate examination of the Town Planning Institute; the third course was offered to anyone who was interested in planning but who was not seeking a particular qualification. Jaqueline Tyrwhitt presented the courses' curricula in a sort of open day of the school on 19 October 1944. Each one of the courses had specific goals: the first course in particular aimed to mitigate the disruption of the education of those who had been demobilised, but all three courses aimed to introduce post-war reconstruction planning principles and to build a cultural basis for the restoration of cities and towns after the conflict.

The course was organised in three main parts: Background for Planning, Planning Factors and Planning Practice. Background for Planning contained a general introduction of basic concepts, such as the shaping of the urban environment, the land use policies and the importance of taking into account the nature of the existing context: Rural Community and Urban Community were illustrated as models in this part of the course, together with a brief history of town planning in Britain. Planning factors introduced social aspects of town planning and the methods to obtain information. A major part was dedicated to different kinds of survey and analysis, including social survey. For this part of the course, Jaqueline Tyrwhitt had the aid of the sociologist Ruth Glass, at the time considered a notable exponent of the field. A number of quite innovative concepts were introduced in the lectures, for example, the idea to establish a community centre integrated within the planning layout, to serve as a gathering place for the community and that was associated with democratic values.<sup>4</sup> Another chapter of the Planning factors part included the list and structure of the institutions and local administrations entitled to be involved in planning decision, with their areas of influence. This was particularly important in operative terms, as the planners formed at the war correspondence course were trained to serve in the local town and county councils and therefore it was instrumental for them to know the system they would work in. Planning Practice, the third and last part of the course, considers planning to a larger scale and the necessity for regional surveys. One of the topics introduced was the concept of interdependence of planning decisions and their impact on the social and economic context. The potential scale of consequences of decision making on an area beyond its boundaries was illustrated to justify the need of an effective integration between different aspects of the rural and urban planning.

Some lessons concerned urban settlements as part of a wider system such as the attention dedicated to traffic and connectivity, the study of the relationship between the town centres and the open countryside, and the importance of woodlands. The last lesson, titled Interpretation of Survey, was dedicated to land use on a regional scale and the centrality of the analysis of the existing context. This is particularly representative of the influence derived from one of Tyrwhitt's most important mentors: the Scottish biologist Patrick Geddes (1854–1932). During his life spent between the United Kingdom and India, Geddes introduced pioneering studies in urban planning. He explored the complex interaction between natural and man-made systems and coined neologisms such as the term 'conurbation'. Geddes also extended the study of urban settlements to the regional scale, elaborated the 'conservative survey' as a design method in urban areas, and underlined the essential importance of the preliminary research on the existing contexts before proceeding to the draft of new proposals for a place. Moreover, he urged the study of the interrelationship between built form and social problems in the city. He was, in Tyrwhitt's and others' opinions, 'the father of

<sup>3</sup> Zalduendo, "Jaqueline Tyrwhitt's," 4.

<sup>4</sup> Zalduendo, "Jaqueline Tyrwhitt's," 8.

the town planning,<sup>5</sup> and his influence is well-reflected in Tyrwhitt's work.

The war correspondence course consisted of a sequence of lectures sent as booklets; theoretical and practical knowledge were closely related in every issue. The synthesis of knowledge in planning was very hard to achieve in the form of the few pages sent to the war front, and Tyrwhitt's task consisted in coordinating the various contributions and editing the publication. One of the goals of the course was to introduce the concept of collaborative work: the program trained the students to work in teams and to relate to statistics and surveys made by professionals from other branches of knowledge. Probably the most innovative aspect introduced in the lectures was the bridging nature of the town planning field, which in Tyrwhitt's mind had to mediate, translate and orient a multiple series of contributions from different experts. In her mind planners must be the final 'shapers of the environment'<sup>6</sup> the conductors of the orchestra. The program of lectures and the structure of the school were practice-orientated. At the end of every part students had to complete a test, with written text, diagrams of sketches and plans, which had to be posted back and checked by the teaching board. Jaqueline Tyrwhitt was also in charge of putting together a team of individuals from different backgrounds and involving economists, planners, geographers and many other experts. The group in charge of writing the lectures was formed, finally, by thirteen specialists, plus other staff members also coordinated by Tyrwhitt. The graduates of the war correspondence course were qualified to be associate members of the Town Planning Institute.

The headquarters of the APRR, the association that ran the war correspondence course, was established in 153 New Bond Street, in London. During an air raid in London the building housing the APRR offices was damaged. However, Tyrwhitt managed the continued operations of the School with the important help of Judith Lebedoe (1901–1990). She, a successful architect and a leading force in post-war Britain, was also the co-founder, with two other women, of the Housing Centre in London.

Until 1947, the APRR worked on two fronts, research and education. They conducted research surveys in preparation for town and country planning schemes, and provided education to the hundreds of new planners that contributed to the reconstruction of the English and American cities. Because of the unconventional situation during the war Jaqueline had the opportunity to put into practice a multidisciplinary model, and the experience she gained with the APRR was essential also for her approach in her course at the Harvard University where she started to teach in 1954. In this period she started her first lecture tour of foreign universities, sent by the British Ministry of Information to present Town Planning Policies under War Conditions in the US and Canada.

From these lectures Tyrwhitt extracted the contents to set a proper educational publication, titled *The Town and Country Planning Textbook*. On the back cover the publication is presented as 'an indispensable book for town planners, architects, and students,'<sup>7</sup> and was finally published in 1950. The textbook was a compendium of different contributions selected from the lectures sent by post. It counted 29 authors of different disciplines, among them some long term collaborators of Tyrwhitt, for example Brenda Colvin, Ruth Glass, and some of her mentors, for example Sir George Pepler and Lord J. Forrester. The anthology is presented as a collection of studies that reflects the nature of the town planning discipline, demonstrating how it is not constrained by fixed boundaries and how it is cross fertilised by several branches of knowledge. Particular relevance is given to the comprehension of a survey method for the economic, social and geographic conditions of an existing context. The textbook was intended to be used as an introduction of all the subjects a planner should be aware of before making any judgement or planning decision. The design process is described as central in the work of the planner. All the elements of architectural design are described as essential and none –for example proportion, harmony and contrast, colour and unity– are subject to compromise.

Jaqueline wrote a chapter for the textbook, entitled 'Survey for Planning', where she 'provides the first explicit discussion of 'the overlay technique'.<sup>8</sup> The layering concept was introduced in the 19th century in landscape architecture and planning. The maps, hand-drawn through sun prints produced on windows, have been used by professionals such as Frederick Law Olmsted, Lynn Miller and Charles Eliot, but it was only an operative procedure at the time, with no theoretical explanation. The method was known by different names, for example 'the sieve method',<sup>9</sup> according to Sir George Pepler. It was popularised by Professor Eva Taylor, who taught Geography at Birkbeck College and was a prominent figure in that field in the UK. She was probably the person who taught Tyrwhitt about the method that consisted of the selection of a defined area, of which the surveyor draws several maps, each one representing a single feature from the survey, drawn on a transparent sheet of paper. All maps have to be to the same scale, with the same framing, and on every layer the surveyor should draught a recognisable element, such as a river or the coastal line. The different layers could then be placed one on the top of the other which allowed the surveyor to see how many factors co-exist in a particular place.

At the APRR Tyrwhitt worked for the production of maps with new survey methods, stimulated by Sir George Pepler 'who had pioneered the application of Geddes' principles of regional survey in the field of planning, just as Taylor had in the field of applied geography'.<sup>10</sup> The cartographic

7 APRR, *The Town and Country Planning textbook* (London: The Architectural Press, 1950).

8 Carl Steinitz, Paul Parker and Lawrie Jordan, "Hand-Drawn Overlays: Their History and Prospective Uses," in *Landscape Architecture* 66, no. 5 (1976), 444–55.

9 Sir George Pepler papers, drawer 13 Box 4 Folder 9, University of Strathclyde Archives, Glasgow.

10 Shoshkes, *Jaqueline Tyrwhitt*, 62.

5 Milos Perovic's interview to Jaqueline Tyrwhitt, in "Mary Jaqueline Tyrwhitt: In memoriam," *Ekistics* 52 (September–October 1985).

6 Perovic, "Mary Jaqueline Tyrwhitt, 420.

investigation was, in Tyrwhitt's mind, just part of a broader issue concerning scientific planning, and the research about survey tools aimed to provide instruments to read the existing reality of the city and to analyse new projects. Visual data can, in fact, convey large amount of information about space in a concise manner, whether the data concerns an existing condition or a new proposal. The overlay technique now constitutes the basis for all Geographic Information System (GIS) software, as for Computer Aided Design (CAD) and graphically-oriented software such as Adobe Photoshop. What started just as a survey method, but later became a design tool, and now the overlay technique is widely used in all technical drawing, analogue and digital. Especially from the 1990s both geography and spatial planning have seen a growing influence in using computational tools in spatial analysis and in spatial design.<sup>11</sup> The layer technique is now a widely used system that helps to organise data according to their spatial location, and it is still applied on a daily basis by researchers and professionals.

The overlay technique was accepted and implemented during the reconstruction phase after the Second World War and for the application of the New Town Act, for which the course directed by Tyrwhitt had been founded and supported. Some of the students who enrolled in the course implemented the principles absorbed at the APRR. One of the students of the correspondence course offered by Tyrwhitt after the war was Ian McHarg, who later became a Scottish landscape architect and a renowned writer on regional planning. From Tyrwhitt's course he was introduced to the concept of suitability analysis, an important factor in his career. After the course McHarg committed himself to promoting a better relationship between the built space and the natural environment. He was convinced that one of the reasons why the environment was not properly integrated as an aspect in planning and design project was the lack of knowledge about the territory, and he used the overlay technique to quantify and display information, and make them meaningful. Later in his career McHarg worked on methods and techniques for ecological planning and he 'provided an orderly procedure for ecological planning. [...] This procedure involves overlaying mapped information to reveal opportunities and constraints for potential land uses.'<sup>12</sup> The overlay technique was then been popularised by McHarg's work. This episode constitutes only one of the possible examples of the evolution to which Jaqueline Tyrwhitt contributed and which was triggered and promoted through her teaching and editing.

The real influence of the war correspondence course post-war is hard to measure, but certainly the breadth and depth of the studies at the APRR, both in terms of research and educational programs,

has been extraordinary and had no equal at the time the course was launched. This experience might have been limited in terms of number of students, or number of publications, but clear signs of echo can be found in further experiences in Tyrwhitt's career, especially in the foundation of the Urban Design Faculty. What emerged from this investigation about Jaqueline's career is that her experience with the APRR was extremely important in shaping her personal thinking about architectural and planning education, and the result of this influence can be found in her late career at the Graduate School of Design at Harvard, for example, in the promotion of 'a model of training based both on theory and practice'.<sup>13</sup> Jaqueline's choices for both the correspondence course and the textbook derived from her interest in crossing humanistic and scientific cultures, reflecting her thought as educator and planner.

Jaqueline Tyrwhitt managed to transform a temporary and quite unstable situation, in this case the replacement as school director during the war, into a unique opportunity to experiment and venture into new paths for the development of a discipline, and the reconstruction of a country.

11 Jeroen Van Schaick and Ina Klaasen, "The Dutch Layers Approach to Spatial Planning and Design: A Fruitful Planning Tool or a Temporary Phenomenon?" (article, Department of Urbanism, Faculty of Architecture, Delft University of Technology), [https://www.academia.edu/812633/The\\_Dutch\\_Layers\\_Approach\\_to\\_Spatial\\_Planning\\_and\\_Design\\_A\\_Fruitful\\_Planning\\_Tool\\_or\\_a\\_Temporary\\_Phenomenonpaper](https://www.academia.edu/812633/The_Dutch_Layers_Approach_to_Spatial_Planning_and_Design_A_Fruitful_Planning_Tool_or_a_Temporary_Phenomenonpaper) downloaded from the author profile on academia.eu (accessed February 3, 2015).

12 Ian L. McHarg and Frederick R. Steiner (eds.), *To Heal the Earth: Selected Writings of Ian McHarg*, (Washington: Island Press, 1998), 203–5.

13 Zalduendo, "Jaqueline Tyrwhitt's," 2.

**Paola Zanotto**

IUAV University of Venice



Paola Zanotto graduated with distinction from the University of Venice, Italy, in 2010. In July 2015 Paola completed an international PhD program in architecture with a thesis on the construction of new knowledge and theory-making process about Cities, illustrated from the point of view of the English town planner, educator and editor Jaqueline Tyrwhitt. Since 2010 Paola has been carrying out her PhD research and working in architectural practices in Italy and the UK, as she considers theoretical research and professional activity mutually enriching and stimulating.

E-mail: [paola.zan8@gmail.com](mailto:paola.zan8@gmail.com)



Helena Seražin

## The Home Introduction

'The House is Her World.' With the separation of work and family life, which took place as early as the 19th century, the bourgeois family home lost its decisive function as a space of production and became the area dedicated to the families' reproduction and rest. The woman was faced with the task of creating a lovely home and space for family representation, while her domestic chores within the 'non-working environment' ceased to be recognised as a proper work. Due to the specific socialisation of women –the system that legitimised the patriarchal authority, which prescribed women's lives by denying them of their own abilities and promoting their singular role as housewives, wives and mothers– the ideas of the 19th century persisted in the European society long into the 1940s and 1950s, most ardently in dictatorship regimes such as Franco's Spain. As Ana María Fernández García explains in her article, a special women's organisation, called Women's Section organised training courses for women as 'home managers', where they learned mostly about house-keeping. With State and Church prescribing and controlling domestic life, women lost what had remained of their independence. The courses trained them in the newly revived popular craftwork, decoration, furnishing and manual arts, providing an alternative to developing their creativity through higher education, which was not available to them.

With women's changing social status and their fight for equality and independence from the end of the 19th century onwards, improvement of domestic life became one of the priorities. Women's magazines such as the Dutch Feminist *De Werkende Vrouw* (The Working Woman) or Slovene *Žena in dom* (Women and Home), *Ženski svet* (Women's World) and *Gospodinja* (Housewife) advocated the Modern Movement of the 1920s and 1930s, seeking purity and simplicity in the design through rationalisation, standardisation and geometry. This functional aesthetic was in tune with striving for efficient domestic work which would provide women with more time for their professional activities and participation in public life. On the other hand, a visually professionalised working place such as the kitchen (the Frankfurt kitchen by Margarete Schütte Lihotzky) was supposed to increase the status of the housewife and acknowledge her domestic work. However, by adopting 'male' functionalism (e.g. by Gerrit Rietveld), which held the 'bad bourgeois female taste' in disregard, feminists such as An Harrenstein Schröder paradoxically surrendered the last distinctly 'female' domain to men and, as Naomi Verbeek concludes in her article, 'women could only achieve equality by adopting male values.' An exception to the rule is the case of Slovene women's magazines which

spread ideas about modern housing culture, amongst others. Based on her analysis, Alenka Di Battista established that the articles were written by leading Slovene male functionalist architects and their female colleagues, the first generation of Slovene women architects. While all authors (regardless of gender) tackled similar topics on interior design, furniture design or house design for middle-class readers, women architects also contributed the ground-breaking articles on working class apartments, farmhouse architecture and landscape design, being aware of the fact that not all their readers could afford the lifestyle pictured in most of the articles.



## ‘De Werkende Vrouw: in Huis en Maatschappij’: Dutch Feminism, Fashion and Design 1930–1931

This paper focuses on an Amsterdam based feminist magazine published from 1930 to 1931 called *De Werkende Vrouw: in Huis en Maatschappij* (The Working Woman: at Home and in Society). The magazine’s founder and editor-in-chief An Harrenstein-Schröder was connected to members of Dutch women’s right movements as well as avant-garde modernist artists and designers. She created a magazine that had a unique perspective for the Netherlands. On the one hand it promoted equality in the workplace and better chances for women to enter all professions. On the other hand *De Werkende Vrouw* is a rich source of articles on the rational modern home, avant-garde design, and progressive fashion and workwear.

This paper seeks to analyse the relationship between the social and feminist ideals and the interior design and fashion promoted by the magazine. I will argue that the former highly influenced the latter. In doing so, I will try to shed new light on the connections between the Dutch modernist movement and contemporary feminist thinking. My discussion furthermore includes the role that gender connotations played in the way the interior decoration, design and fashion were viewed in the 1930s and the notions of ‘good’ and ‘bad’ taste.

Keywords: magazines, the modern home, avant-garde design, gender identity, fashion

### Introduction

This research focuses on a Dutch feminist magazine called *De Werkende Vrouw: in Huis en Maatschappij* (The Working Woman: At Home and in Society). The Amsterdam-based magazine was first published in January 1930 and continued to be published regularly until September 1931, with a total of 14 issues (Table 1). In this paper I will try to answer the following question: In what way are the social and feminist ideals that are promoted in *De Werkende Vrouw* reflected in the design, fashion and domestic culture shown in the magazine? I will argue that the social agenda of the magazine highly influenced the fashion and interior design choices that were made by the editorial office and I will clarify the particular role founder and editor-in-chief An Harrenstein-Schröder (1888–1951) has played in this.

To do so, I will first elaborate on the social ideals of *De Werkende Vrouw* to further clarify their feminist goals. Leading women from the Dutch women’s rights movement wrote engaged articles, interviews and opinion pieces on women’s labour, career opportunities, working conditions, women’s clubs, and marriage law. The magazine’s aim was to reach a modern group of women with ambition, who wanted to combine a career with taking care of their homes, household and families. In *De Werkende Vrouw* they found a great number of articles supporting their ideas.

At the same time *De Werkende Vrouw* contained articles with very modern ideas on design, the home and fashion. The fashion section showed the latest trends, as well as work- and sportswear. In the second part of this paper I will further examine the relation between the editorial fashion choices and the identity of the target audience of the magazine. In order to understand the magazine it seems important to understand who this 1930s ‘working woman’ was. I will argue that the feminist ideals of the magazine were reflected in these fashion choices.

Finally, with these issues addressed, the content of the magazine on the modern home will be analysed. Efficiency, the rational kitchen and innovative social housing projects were brought to the attention of the readers in almost every edition. But even more interesting is the fact that avant-garde artist Gerrit Rietveld also contributed to the magazine by submitting articles with his ideas on



Fig. 1. The cover of *De Werkende Vrouw* in March 1930, with the lay-out designed by Gerrit Rietveld (photographer: Verbeek, with permission of Atria, Institute on Gender Equality and Women's History).

architecture and interior design.<sup>1</sup> An Harrenstein-Schröder was not only connected to well-known women's rights activists and writers, but also surrounded herself with artists who visited her home in Amsterdam frequently, and Rietveld was amongst them.<sup>2</sup> He was responsible for building the famous Rietveld Schröder House in Utrecht in 1924.<sup>3</sup> The inhabitant and co-designer of the dwelling, Truus Schröder-Schröder (1889–1985), was the sister of An Harrenstein-Schröder.<sup>4</sup> Together with Rietveld, she influenced the magazine in a crucial way. Six years thereafter, Rietveld also designed the cover of *De Werkende Vrouw* (Fig. 1).

It is only within this context that *De Werkende Vrouw* has been addressed briefly in a small number of publications until now.<sup>5</sup> Alice T. Friedman and Marjan Groot both mention the magazine's existence but do not elaborate much on the subject. By researching the altogether rare magazine, new light might be shed on the connections between the Dutch Modernist Movement, contemporary feminist thinking, and (social) ideas behind design of the 1920s and 1930s in the Netherlands. The discussion of the magazine, furthermore includes the role that gender connotations play in the editorial choices which were made in the compilation of the design and fashion content of the

magazine. The gender perspective is crucial in understanding the connection between the social ideals and the promoted interior and fashion.

## Women and society: Feminism in *De Werkende Vrouw*

At the end of the nineteenth century the resistance against the subordination of women grew stronger and became more organised in the Netherlands.<sup>6</sup> Women of the first feminist wave (which lasted from approximately 1880 until 1920) demanded more political influence and economic independence. Middle class women were leading in the foundation and organisation of unions such as the *Nationale Vrouwenraad* (National Women's Council) in 1878 and the *Nederlandse Vereniging voor Vrouwenkiesrecht* (Dutch Union for Women's Suffrage) in 1894. Their position had been even more limited than the one of working class women. Middle class women were expected to solely focus on their housekeeping tasks and the upbringing of the children once they were married, and when the income of the husband was enough to make ends meet. They had no alternative lives.

The value of women's labour was, despite this, celebrated at the *Nationale Tentoonstelling van Vrouwenarbeid* (National Exhibition of Women's Labour) in The Hague in 1898: a landmark exhibition organised by over 500 women.<sup>7</sup> It combined shows on trade, industry, and applied arts with congresses on women's issues. With over 94,000 visitors the exhibition was a great success.<sup>8</sup> From the profit of the exhibition the *Nationaal Bureau voor Vrouwenarbeid* (National Bureau of Women's Labour) was founded in 1901. The bureau was supposed to realise the goals set by the *Nationale Vereniging voor Vrouwenarbeid* (National Union for Women's Labour).<sup>9</sup> Their main goal was to create a better position for women on the labour market and motivate women to get an education. The director of the bureau was Anna Polak (1874–1943), who was also involved with the organisation of the 1898 exhibition.<sup>10</sup> She was a well-known feminist who frequently wrote for *De Werkende Vrouw* as an expert on social and economic issues. The magazine offered her, and her deputy director Marie Heinen (1881–1948)<sup>11</sup> amongst many others, a podium for their opinions on women's issues in relation to marriage law, social status, and most of all their position in the field of work and opportunities for education. Whereas the Dutch government granted women the right to actively vote in 1919, their position in relation to labour and marriage remained subordinate.<sup>12</sup> Because of the worldwide economic crisis at the end to the 1920s, women's emancipation seemed to stagnate. Women were the first to lose their jobs during the crisis, and were seen as a threat to the employment

- 1 Gerrit Rietveld, "Rapport van de studie-commissie inzake praktische woninginrichting," *De Werkende Vrouw* 1, no. 7–8 (1930), 230; Gerrit Rietveld, "De stoel," *De Werkende Vrouw* 1, no. 9 (1930), 244; Gerrit Rietveld, "Architectuur," *De Werkende Vrouw* 1, no. 11–12 (1930), 316–318.
- 2 Elina van Tuinen-Taselaar, *Jacob Bendien 1890–1933* (Utrecht: Centraal Museum; Leeuwarden: Fries Museum, 1985), 9.
- 3 Ype Koopmans, "Schenking schilderij Charley Toorop door Arnhem Arts Ambassadors," *Museumkrant Museum voor Moderne kunst Arnhem* (Spring 2010), 2.
- 4 Marjan Groot, *Vrouwen in de Vormgeving 1880–1940* (Rotterdam: Uitgeverij 010, 2007), 405.
- 5 Alice T. Friedman, *Women and the Making of the Modern House: A Social and Architectural History* (New Haven: Yale University Press, 2006), 87; Groot, *Vrouwen in de Vormgeving*, 405.

- 6 B.M.A. de Vries et al., *Van agrarische samenleving tot verzorgingsstaat: Demografie, economie, maatschappij en cultuur in West-Europa, 1450–2000* (Groningen: Martinus Nijhoff Uitgevers, 2000), 375–376.
- 7 Maria Greve and Berteke Waaldijk, *Feministische openbaarheid: De nationale tentoonstelling van vrouwenarbeid in 1898* (Amsterdam: Stichting beheer IISG, 1998), 274.
- 8 Ibid.
- 9 Hélène van der Veer, "Polak, Anna Sofia," in *Biografisch Woordenboek van het Socialisme en de Arbeidersbeweging in Nederland 3* (1988), 169–172, <http://socialhistory.org/bwsa/biografie/polak-a> (accessed September 10, 2015).
- 10 Grever and Waaldijk, *Feministische openbaarheid*, 274.
- 11 Marie Heinen presumably wrote under the initials 'M.H.'
- 12 De Vries, *Verzorgingsstaat*, 375–376.

status of men.<sup>13</sup> And even in 1924, a law was passed by the government stating that female public servants would receive an honourable discharge on their wedding day.<sup>14</sup> During the brief existence of *De Werkende Vrouw*, the magazine served as an important medium for feminist theorists and intellectuals such as Polak and Heinen who firmly expressed their opinions on the issues that still remained urgent after the highlight of the first feminist wave.<sup>15</sup> This way, the magazine hoped to be a platform for discussion and dialogue among women, but also to be able to support one and other.

Anna Polak described for instance in 'Ambten voor vrouwen gesloten' ('Occupations closed for women'), the injustice of women still being restricted from certain professions.<sup>16</sup> In her articles on women's labour she also urged women to get a good education and fulfil their true potential since they did not know whether they would marry or whether they could depend on their husbands for the rest of their lives.<sup>17</sup> The articles written by Marie Heinen were meant to give advice to young and unmarried women who wanted to work and lead an independent life in the city. She wrote a column called 'Uit het leven van de werkende vrouw' ('From the life of the working woman'), in which she described in a lively manner the way ambitious women were the pioneers of a new emerging lifestyle.<sup>18</sup> In general, *De Werkende Vrouw* hoped to inspire women to aim for a career, even after they got married. The magazine therefore published a number of interviews with women who succeeded in doing so.<sup>19</sup>

An exemplary woman, who was not only interviewed for the magazine, but also submitted two articles herself, was Clara M. Meijers (1885–1964).<sup>20</sup> She was an executive secretary for the banking association of Rotterdam, and later became the director for a branch office in Amsterdam.<sup>21</sup> This new bank was founded especially to serve women, and provided credit to those who wanted to start their own business. The women's bank frequently placed advertisements in *De Werkende Vrouw* (Fig. 2). Meijers also became the secretary for National Union of Soroptimist Clubs in the Netherlands. This rather elite club, a female counterpart for the Rotary service clubs, was founded in 1928 by Rosa Manus –a well-known Jewish feminist– and modelled after the American example. The Dutch Soroptimist Club was intended especially for working women and provided an important network for



Fig. 2. Advertisement placed by the Rotterdamse Bankvereniging in *De Werkende Vrouw* (March 1930) (photographer: Verbeek, with permission of Atria, Institute on Gender Equality and Women's History).

the authors of *De Werkende Vrouw*.<sup>22</sup> The group mainly consisted of highly educated upper middle-class women who were involved in the feminist movement. Every single member of the club used to have a different profession, so the network would remain as diverse as possible. Marie Heinen and Truus Schröder-Schröder were, amongst other writers of the magazine, members of the club as well.

Besides the goal of bettering chances for women's economic independence, *De Werkende Vrouw* also supported the idea of enhancing the status of the housewife. This view is expressed in an article written by Anna Polak in which she states that the *Centraal Plan Bureau* (Bureau for Economic Policy Analysis) should consider the full-time housewife as employed instead of unemployed. When the housewives would be registered

as 'employed' by the governmental organisation, they would receive more recognition for the work they performed.<sup>23</sup> The editors of *De Werkende Vrouw* claimed in a statement to want to inspire every working woman, including housewives, through the articles in the magazine. Yet the desire to be able to choose to work outside as well as inside the home during marriage remained the most important goal.

Editor-in-chief An Harrenstein-Schröder was able to attract women who were involved with the leading women's issues organisations in the Netherlands to write for *De Werkende Vrouw*. When the magazine is compared to another Dutch women's journal such as *De Vrouw en haar Huis* (The Woman and her House) the emphasis on women's issues becomes even more clear. The editor-in-chief of this magazine, Elis M. Rogge, and the other writers of the magazine, were also involved with the Soroptimist Club and the exhibition of 1898. Even though they covered many of the same subjects, the approach and tone of the articles in the magazine was slightly different. The relative number of articles on women's labour in *De Werkende Vrouw* was simply larger, more extensive, and came across as more activist and urgent. The writers of *De Vrouw en haar Huis* mentioned and supported some of the latest developments on women's labour but this never became the main issue of the magazine. The realm of the home remained the most important female domain in *Vrouw en haar Huis*, which is, in the end, in contrast to the ideals of *De Werkende Vrouw*.<sup>24</sup>

13 Amoud Jaspers et al., *Bericht uit 1929: Het veelzijdige gezicht van de Nederlandse samenleving ten tijde van de oprichting van het PTT Museum* (Den Haag: Stichting Het Nederlandse PTT Museum, 1989), 33.

14 Anna Polak, "De Nederlandsche gehuwde vrouw in overheidsdienst," *De Werkende Vrouw* 1, no. 9 (1930), 236.

15 Friedman, *Modern House*, 87.

16 Anna Polak, "Ambten voor vrouwen gesloten," *De Werkende Vrouw* 1, no. 5 (1930), 136.

17 Anna Polak, "Vrouwenarbeid II," *De Werkende Vrouw* 1, no. 3 (1930), 71.

18 M.H. [Marie Heinen], "Uit het leven van een werkende vrouw," *De Werkende Vrouw* 1, no. 1–2 (1930), 37–38.

19 S.J.P., "Een vrouw als bedrijfsleidster," *De Werkende Vrouw* 1, no. 1–2 (1930), 4–6.

20 Clara Meijers, "Een internationale voorlichtingsdienst voor werkende vrouwen," *De Werkende Vrouw* 1, no. 7–8 (1930), 187; Clara Meijers, "Een vrouw, die slaagde," *De Werkende Vrouw* 1, no. 9 (1930), 249–250.

21 Francisca de Haan, *Gender and the politics of office work, the Netherlands 1860–1940* (Amsterdam: Amsterdam University Press, 1998), 91.

22 Groot, *Vrouwen in de Vormgeving*, 209.

23 Anna Polak, "Wordt het huisvrouwschap officieel als beroep beschouwd?," *De Werkende Vrouw* 1, no. 10 (1930), 262.

24 Groot, *Vrouwen in de Vormgeving*, 38.

## The Working Women and Fashion

In their article 'Conceptualizing fashion in everyday lives' design- and fashion historians, Cheryl Buckley and Hazel Clark, argue that research of the history of clothing of daily life is just as important as the study of avant-garde fashion. The traditional focus of study lies with exclusive and exceptional couture fashion worn by the wealthy elite and therefore the clothing worn by 'ordinary' women might end up being overlooked. Yet for the 1920s and 1930s, everyday fashion has historical value within the context of modernity and mass-consumption. Because of female mass magazine readership, fashion prints reached middle class women on a weekly or monthly basis and influenced the way women behaved as consumers on a large scale. More importantly, fashion can be seen as an instrument for women to define themselves and consciously or unconsciously create their identities within the context of their social groups.<sup>25</sup>

It is with this argument in mind that it is interesting to analyse the fashion images and articles of *De Werkende Vrouw* in relation to the identity of the target audience. Who were those working women exactly, and what did they wear and for what reason? As Marie Heinen described in her advice columns, young women with urban jobs formed a new social phenomenon. In the decade prior to the publication of *De Werkende Vrouw* a new look had emerged in the cities of the Netherlands: *la garçonne*. This boyish look with short hair and skirt became the symbol of the young and spirited career woman who had fought her way into the workplace and public sphere.<sup>26</sup> In the fashion items of *De Werkende Vrouw* this look can be seen frequently. The magazine featured fashion illustrations and articles almost on a monthly basis, displaying not only the latest trends for the season but different types of workwear as well. The first edition of *De Werkende Vrouw* in 1930 showed three different types of practical professional clothing: an illustration of an apron, a woman gardener wearing dungarees and a woman wearing culottes (Fig. 3). The text explained what kind of work they were suited for and in what kind of fabrics

they were supposed to be made. The culottes for instance were suggested as suitable attire for gymnastics teachers. Besides outfits to work in, the magazine also showed some sportswear to

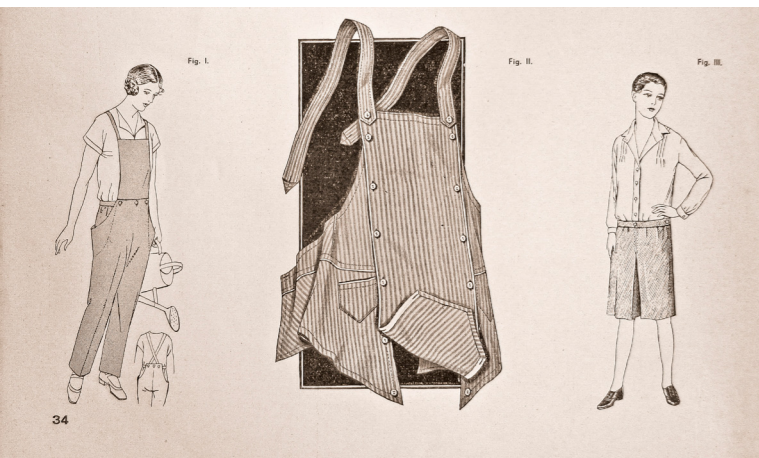

Fig. 3. Illustrations of 'Praktische beroepskleding' ('Practical workwear') in *De Werkende Vrouw* (January-February 1930) (photographer: Verbeek, with permission of Atria, Institute on Gender Equality and Women's History).



Fig. 4. Illustration of sportswear in *De Werkende Vrouw*, 1930 (photographer: Verbeek, with permission of Atria, Institute on Gender Equality and Women's History).

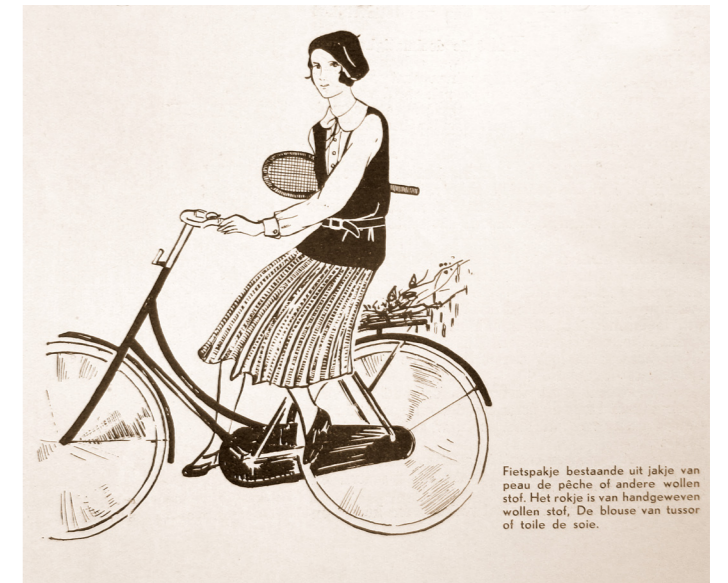

Fig. 5. Fashion illustration in *De Werkende Vrouw*, 1930 (photographer: Verbeek, with permission of Atria, Institute on Gender Equality and Women's History).

play hockey with or ride a bike in (Figs. 4 and 5). In context of the professional clothing and the sportswear the fashion illustrators of *De Werkende Vrouw* showed women wearing trousers. Katina Bill explains in her article on the evolution of trousers in the twentieth century that the general attitude towards women wearing trousers was still quite hostile.<sup>27</sup> The idea that trousers were still not completely free of controversy is supported by fashion historian, Elizabeth Wilson, in her book *Adorned in Dreams*.<sup>28</sup> Still, wearing trousers became slowly more acceptable after First World War, and it had a symbolic as well as a sportive and functional utility. According to Wilson, wearing trousers became a symbol of the striving for equality, and the increasing freedom of women and modernity. But at the same time, she argues, while women remained unequal, trousers also symbolise the myth of emancipation, for it was only acceptable to wear trousers on certain occasions (such as physical labour and sports).<sup>29</sup> Moreover, from a gender perspective, wearing trousers remained problematic because it also exposed the fact that the progress women made was only possible by adopting male values and terms, such as their way of dressing.

The way *De Werkende Vrouw* represented women in their fashion illustration is significant in relation to their ideals. For instance: in the complete 1930 run of *De Vrouw en haar Huis* not one single woman in trousers was shown, neither women working nor playing sports. Fashion had a larger

<sup>25</sup> Cheryl Buckley and Hazel Clark, "Conceptualizing Fashion in Everyday Lives," *Design Issues* 28, no. 4 (2012), 18, 22 and 28.

<sup>26</sup> De Vries, *Verzorgingsstaat*, 378.

<sup>27</sup> Katina Bill, "Attitudes Towards Women's Trousers: Britain in the 1930's," *Journal of Design History* 6, no. 1 (1993), 47 and 54.

<sup>28</sup> Elisabeth Wilson, *Adorned in Dreams: Fashion and Modernity* (London: Virago Press, 1985), 164–166.

<sup>29</sup> Wilson, *Dreams*, 165.



Fig. 6. Fashion illustration in *De Werkende Vrouw* (September 1930) (photographer: Verbeek, with permission of Atria, Institute on Gender Equality and Women's History).



Fig. 7. Fashion illustration in *De Werkende Vrouw* (October 1930) (photographer: Verbeek, with permission of Atria, Institute on Gender Equality and Women's History).

share in the content of this magazine, but the illustrations usually showed fashion for at home or in the theatre.<sup>30</sup> Women were more often depicted at home with their children, and on fewer occasions were seen outside. Representing women at work, outside or playing sports can be seen as a way for *De Werkende Vrouw* to communicate their ideals through their fashion content. This way, the magazine distinguished itself from *De Vrouw en haar Huis*. Even more so because both magazines were read by the same type of audience: bourgeois women from the upper middle-class, such as An Harrenstein-Schröder and Clara Meijers. This is reflected and confirmed in the rather luxurious fashions that were shown in both magazines. *De Werkende Vrouw* showcased, for instance, clothing for three different moments of the day (Fig. 6) and executed in expensive materials such as a chic fur collar and a leather coat (Fig. 7). This type of wardrobe was only affordable for women with a reasonable income, such as Harrenstein-Schröder who was supported by her husband who worked as a doctor.<sup>31</sup> Nevertheless, it remained important for the editors of the magazine to include their social ideals and to also represent the working woman in their fashion illustrations.

<sup>30</sup> *De Vrouw en haar Huis* (1930), 482–485.

<sup>31</sup> Ype Koopmans, "Architectuur – Schilderkunst – Beeldhouwkunst: Nieuwe Beelding en Nieuwe Zakelijkheid," *Arnhemse Cahiers* 6 (2004), 13.

## The Working Woman and Her Home

What makes *De Werkende Vrouw* interesting in relation to design history of the 1930s is the attention the magazine paid to the home in general and avant-garde interior in particular. In the last part of this paper I will analyse how the social ideals of the magazine were reflected in the presented interior and argue that the influence of An Harrenstein was crucial to this. The articles on the modern home were mainly published in the year 1930, when An Harrenstein-Schröder was in charge of the magazine. In the November-December issue of that year, an announcement was made that in 1931 the magazine would be led by a different group of editors. Although it was not explained in the magazine, the presumable reason for her departure was the fact that she fell ill during 1930.<sup>32</sup> Her absence made her influence on the character of the magazine clear: the combination of feminist ideals and avant-garde interior was suddenly relinquished in 1931. The articles on design by Truus Schröder-Schröder and Gerrit Rietveld were therefore only published in 1930. Even though content on labour and women's rights did not change much, the magazine showed a different and far more traditional interior to its readers (Fig. 8). It becomes clear that the way An Harrenstein presented the modern interior to a bourgeois female audience was what distinguished the magazine from others at this time.

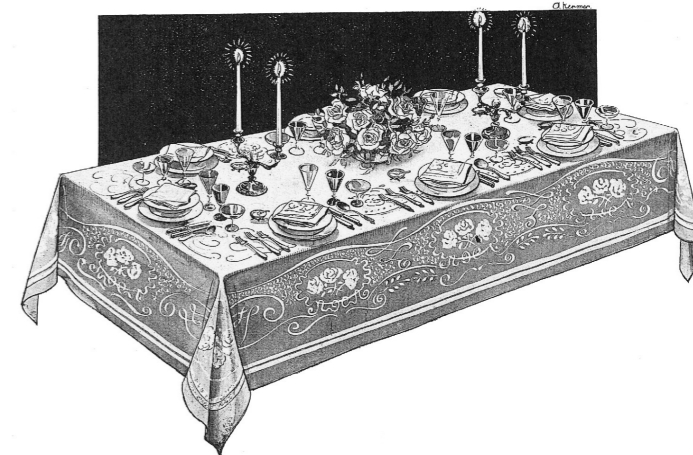

Fig. 8. An example of the interior *De Werkende Vrouw* showed in 1931, after the departure of An Harrenstein (May-June 1931) (photographer: Verbeek, with permission of Atria, Institute on Gender Equality and Women's History).

Harrenstein was an art critic who surrounded herself with avant-garde artists such as Charley Toorop, Jacob Bendien, Kurt Schwitters, César Domela and El Lissitzky. Her home served as a meeting place for these artists.<sup>33</sup> In the article 'Een inleidend woord tot binnen architectuur' ('A preface to interior decoration') written by Truus Schröder, this particular home was discussed and a few photographs were featured (Fig. 9).<sup>34</sup> In 1926, the bedroom of the home was redesigned by Schröder and Rietveld, in a similar style as the Rietveld Schröder House they realized in 1924. In *De Werkende Vrouw* they both shared their vision on interior, furniture and architecture in several articles. Schröder explained in the above-mentioned article that she felt that the most important quality of an interior was that the inhabitant should feel activated and uplifted by it. Like art, the space should create an

<sup>32</sup> Koopmans, "Schenking," 2.

<sup>33</sup> Tuinen-Taselaar, *Bendien*, 9.

<sup>34</sup> Truus Schröder-Schröder, "Een inleidend woord tot binnen architectuur," *De Werkende Vrouw* 1, no. 3 (1930), 93–94.

awareness. When the inhabitant had a busy life, the home should stimulate focus instead of creating passivity. Rietveld shared a similar kind of view in his article "Architectuur" ('Architecture'). He states that the interior should be bright and clear, in order to regain energy and to be able to process the many impressions of modern life.<sup>35</sup> In the articles he wrote for *De Werkende Vrouw* he also held a plea for simplicity. For instance in his text 'De Stoel' ('The Chair') he argues that the chair should be freed from the old-fashioned shapes from the past. New materials and machine-production should make furniture simple and useful again.<sup>36</sup>

Rietveld and the other De Stijl artists, such as Piet Mondriaan and Theo van Doesburg, believed that their avant-garde design and architecture was able to change one's personal life and therefore influence society as well. The idea behind their modern functionalist aesthetic was socially driven.<sup>37</sup> New surroundings would stimulate different behaviour. Their utopian vision on living suggested a more democratic, harmonious and therefore gender-neutral society.<sup>38</sup> When Rietveld was commissioned by Truus Schröder to design her new home together, he was able to apply his vision. The inhabitants of the home (Truus was a mother of three children) were almost 'forced' to live actively. Within the home there were solid elements such as the bathroom and the staircase, but many walls were adjustable and rooms were multifunctional. Each room could be opened or closed and the interior was recreated as needed at that moment. This way, Rietveld completely disregarded the traditional division of the home and stimulated a conscious and disciplined lifestyle.<sup>39</sup> Furthermore, the transparent exterior and interior of the Schröder House together formed a visual whole. The division between inside and outside was therefore dissolved, and this effect was enhanced by the enormous windows on all sides of the house. The traditional separation of the public and private sphere was therefore reduced. This was a significant difference from the comfortable middle class villa Truus had lived in with her late

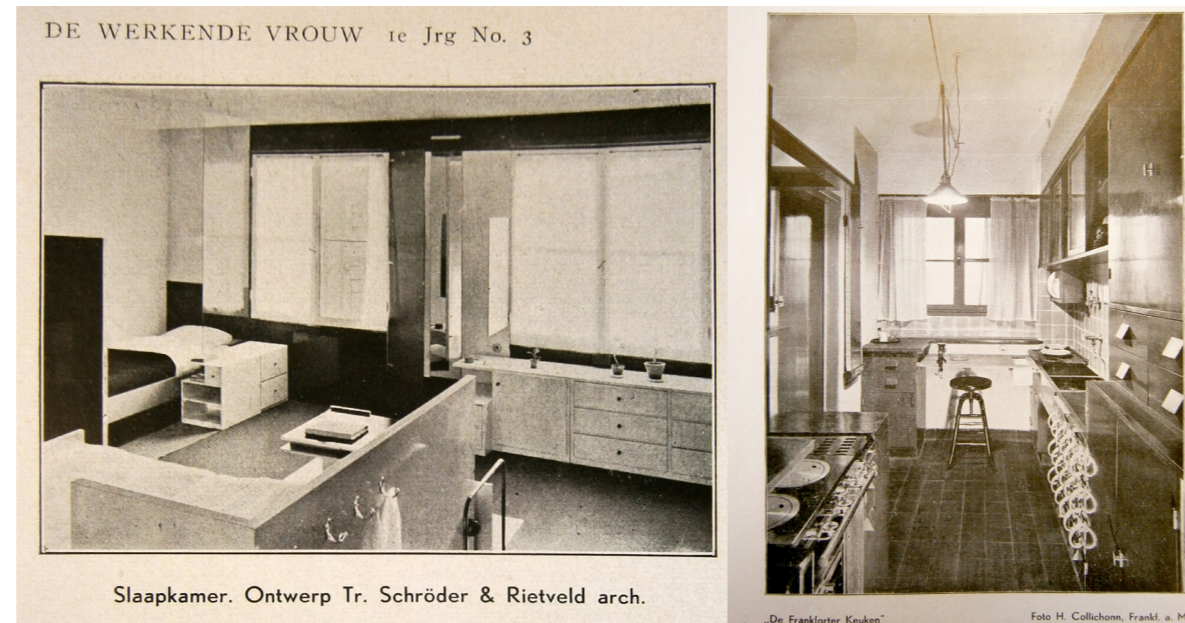

Fig. 9. Photograph of An Harrenstein-Schröders bedroom, designed by Truus Schröder and Gerrit Rietveld in 1926, published in *De Werkende Vrouw* (March 1930) (photographer: Verbeek, with permission of Atria, Institute on Gender Equality and Women's History).

Fig. 10. Photograph of the Frankfurt-Kitchen in *De Werkende Vrouw* (January-February 1930) (photographer: Verbeek, with permission of Atria, Institute on Gender Equality and Women's History).

husband.<sup>40</sup> Her new home was not a closed-off private space, which was a significant feature of the nineteenth century middle class dwelling. This way, the separation of the male and female sphere (the public and the private) that was dominant in the nineteenth century house was visually lifted in the Schröder House.<sup>41</sup> As the financier and co-designer, Truus Schröder influenced the construction of the house not only in her role as interior designer, but also with her ideas as a woman, mother and housekeeper.

Her thoughts on the rational household were also published in *De Werkende Vrouw*. Truus advocated efficiency and the rational use of the kitchen in several articles, for instance, in her text on the Frankfurt-kitchen, designed by Margarete Schütte-Lihotzky for Ernst May's social housing project in this city (Fig. 10).<sup>42</sup> The purely functional and laboratory-like kitchen should save the housewife labour and, therefore, time. *De Werkende Vrouw* featured several articles by different authors on the kitchen, electrification, and efficiency in the home in general. The reasoning behind this can be seen as twofold. First and foremost, the time and labour that was saved by this new efficient and rational household could be spent working part-time, outside the home. Secondly, when the kitchen was designed to be a rational working place (based on the logic of the factory or the laboratory), the home was in a way professionalised, which supposedly increased the status of the housewife.<sup>43</sup> This was one of the main goals in the articles written by Anna Polak for *De Werkende Vrouw*, and was, thus, reflected in a very practical manner in the articles on the home. The design that was shown in *De Werkende Vrouw*, therefore, broke the boundaries between the male and female sphere in a visual and a practical way.

Penny Sparke analyses taste and design from a gender perspective in her book *As Long as It's Pink: The Sexual Politics of Taste* (1995). She argues that modernity is mainly a male domain where science, technique and rationality are dominant. Architecture and design also belong to this

<sup>35</sup> Rietveld, "Architectuur," 317.

<sup>36</sup> Rietveld, "De stoel," 244.

<sup>37</sup> Penny Sparke, *The Modern Interior* (London: Reaktion Books Ltd., 2008), 172.

<sup>38</sup> Nancy Troy, *The De Stijl Environment* (Cambridge Mass.: The MIT Press, 1983), 5.

<sup>39</sup> Carel Blotkamp et al., *De vervoljaren van De Stijl 1922–1936* (Rotterdam: Uitgeverij 010, 1990), 219.

<sup>40</sup> Sparke, *Modern Interior*, 175.

<sup>41</sup> Rita Felski, *The Gender of Modernity* (London: Harvard University Press, 1995), 18.

<sup>42</sup> Truus Schröder-Schröder, "Wat men door normalisatie in den woningbouw te Frankfort a/d Main heeft bereikt," *De Werkende Vrouw* 1, no. 1–2 (1930), 12–14.

<sup>43</sup> Sparke, *Modern Interior*, 134.

sphere.<sup>44</sup> The opposite of 'design' is 'taste': a gendered concept associated with femininity, consumption and domesticity. This female taste prevailed in the nineteenth century home, where the woman was the beautifier of her 'own' space.<sup>45</sup> The rational design of the modernist artist and architect completely disregarded this 'bad' bourgeois female taste for it was seen as too irrational, fashionable and frivolous. Architects such as Gerrit Rietveld sought purity and simplicity in their design through rationalisation, standardisation and geometry. In these efficient modernised spaces there was no room for emotion or comfort. 1920s and 1930s modernist design resisted every association with what was seen as feminine (and therefore of a lower status).<sup>46</sup>

Yet these designs, typical for the male domain, were advocated by An Harrenstein and Truus Schröder in *De Werkende Vrouw*. The functionalist aesthetic predominates the articles about the home, but even though the articles were written by women, female designers or architects do not occur as subject matter. The only exception in this case is Schütte-Lihotzky's Frankfurt-kitchen, but Truus Schröder does not emphasize the fact that the kitchen is designed by a woman.

Penny Sparke concludes that male design and rational values eventually replaced the female taste and influence on the interior of the home. In *De Werkende Vrouw* this was celebrated as liberating: the status of the housewife was enhanced, the efficient and electrified home saved time and labour and the separation between inside and outside was removed in the modern home. Yet from a gender perspective this still remains problematic, for women could only achieve equality by adopting male values. By incorporating the 'good' design that replaced the 'bad' bourgeois female taste that was condemned by twentieth century modernists, women still had to conform to a standard that was set by men.

This can be said for both the fashion illustrations and the articles on the home in *De Werkende Vrouw*. On the other hand, these new fashion and interior styles offered a more active, equal and free life to women such as An Harrenstein and Truus Schröder. This way *De Werkende Vrouw* presented an interesting combination of feminist goals and design for the modern, educated, working woman. An Harrenstein was therefore responsible for a unique and brief encounter between the Dutch modernist and the women's rights movement.

## Appendices

Year	Edition	Month	Pages
I (1930)	1-2	January – February	1-64
I (1930)	3	March	68-95
I (1930)	4	April	99-127
I (1930)	5	May	129-156
I (1930)	6	June	157-183
I (1930)	7-8	July-August	186-232
I (1930)	9	September	233-256
I (1930)	10	October	259-284
I (1930)	11-12	November – December	287-332
II (1931)	1	January	1-24
II (1931)	2	February	25-48
II (1931)	3-4	March – April	49-80
II (1931)	5-6	May – June	83-120
II (1931)	7-8-9	July – August– September	122-160

Table 1. Overview of the editions of *De Werkende Vrouw* 1930–31.

44 Penny Sparke, *As Long as It's Pink: The Sexual Politics of Taste* (London: Pandora/Harper Collins, 1995), 74.

45 Sparke, *Sexual Politics*, 109–111.

46 Sherry B. Ortner, 'Is Female to Male as Nature is to Culture?' *Feminist Studies* (Autumn 1972), 5–31.

**Naomi Verbeek, MA**  
**Leiden University**



In 2014 Naomi Verbeek obtained her master's degree in Arts and Culture at Leiden University. Within this master's program she specialised in the history of design and decorative arts. Her main interest lies in the study of nineteenth and twentieth century design, fashion and art from a gender perspective. She also obtained a master's degree (cum laude) in teaching art history. She currently works as a gallery assistant at Kunstconsult in Amstelveen and as an educator and researcher at the Peace Palace in The Hague.

E-mail: [nrverbeek@gmail.com](mailto:nrverbeek@gmail.com)



## Slovenian Women's Magazines and the Development of the Modern Home Concept in the Thirties

The paper presents several Slovenian women's magazines published during the thirties by different women's societies and emphasises their contribution in the dissemination of knowledge of modern home design among their female readers. By referring to articles on modern home design, written by Slovenian architects of both genders, it analyses how the concept of the modern home developed through the thirties and shows which were the major and most popular topics presented. In this way, the paper underlines similarities and differences between male and female contributors, provides insight into the social and political status of Slovenian women architects during the interwar period and draws attention to the role of women's readers in the promotion of the modern home idea.

Keywords: Slovenia, women's magazines, architects, modern, home

### Historic Background

The First World War and the altered socio-political circumstances left in its wake had a direct influence on the position and role of Slovenian women in society.<sup>1</sup> Considering that the new Yugoslav state left the civil law uncodified and kept the existing legislation in force, the legal status of women varied and they were treated differently in various regions of the multinational state.<sup>2</sup> Generally speaking, they were excluded from political life, as they did not have the right to vote. Most of them, especially workers' and farmers' wives, had to look for employment, usually in the textile and clothing industries and in various trades and were not equal paid. On the other hand, the number of women who attained higher education increased significantly, as they were able to attend grammar schools, vocational schools and universities. For instance, the percentage of girls attending Slovenian grammar schools increased from 11.8 % in 1918–19 up to 35.3 % in 1937–38, and the percentage of female students at the University of Ljubljana grew from 3.6 % in 1919–20 up to 18.5 % in 1937–38. The literacy and thereby level of education achieved by women varied from region to region and the main mission of women remained looking after the home and family.<sup>3</sup>

The situation of women in Slovenia was not very different from that of women in other European countries. According to the lawyer Vito Kraigher the legal status of Slovenian married women was very similar to their status in Austria, Germany and Switzerland. They enjoyed legal capacity and property rights, but were restricted in the choice of their carrier.<sup>4</sup> Their struggle for equal rights was also similar and it began in Slovenia at the end of the nineteenth century in the form of various women's professional, educational, patriotic and charity associations. The struggle gained

- 1 After the First World War most of the territory of today's Slovenia was included in new established multinational Kingdom of Serbs, Croats and Slovenes (1918–29), later named the Kingdom of Yugoslavia (1929–39). It was ruled by the Serbian dynasty of Karađorđević as a unitary state.
- 2 The new Yugoslav state left the civil law uncodified and kept the existing legislation in force. Consequently, within the Slovenian territory the old Austrian *Allgemeine Bürgerliche Gesetzbuch* remained in force until 1941.
- 3 Mateja Jeraj, *Slovenke na prehodu v socializem* (Ljubljana: Arhiv Republike Slovenije v Ljubljani, 2005), 19–37; Aleš Gabrič, "Od moškega do unisex šolstva," in Aleksander Žižek (ed.), *Ženske skozi zgodovino: Zbornik referatov 32. zborovanja slovenskih zgodovinarjev* (Ljubljana: Zveza zgodovinskih društev Slovenije, 2004), 218–219.
- 4 Vito Kraigher, "Žena v sedanjem rodbinskem pravu poedinih evropskih držav," *Ženski svet* 14, no. 9 (1936), 202.

impetus in the interwar period and this was reflected in the women's magazines that were issued by different associations. These periodicals began publishing numerous articles about women's issues such as voting rights and vocational training for women. Authors encouraged women to consider their unequal situation and their role in society. These magazines had content that reinforced the traditional role of women as mothers and housewives in the society as wives presented at the same time: the permanent columns featured articles which dealt with trends in fashion, various women's handicrafts and modern ways of furnishing the home.<sup>5</sup>

Before analysing individual articles by these architects, which are an important source for studying modern living culture from the interwar period, it is necessary to provide a rough outline of the circumstances at the time in which these few women architects were active. In the field of technical studies, 28 females (or 10% of all graduates) graduated from the department of architecture - construction at the Technical secondary school in Ljubljana.<sup>6</sup> Meanwhile, ten female architects graduated from the technical faculty of the University of Ljubljana, also representing around 10% of all graduates.<sup>7</sup> Very little information is available on their lives and professional activity. Only documents belonging to two of them – Dušana Šantel Kanoni and Gizela Šuklje – have been preserved in public and private collections.<sup>8</sup>

I have, therefore, had to construct the broader context of my article with the help of contemporary written sources. An analysis of the written material, which has been collected so far, has shown that society at the time was not favourably inclined to the professional participation of women in the technical field and that some continued to consider them with a fair amount of reservations. For example, the linguist and professor Lovro Sušnik wrote that he does not recommend technical professions for women because, he considered them unsuitable for the female psyche. In the event that they nevertheless chose a technical subject, he would recommend architecture, which he believed, was the most suitable for them out of all the possible options. He also recommended that within architecture they choose interior design or administration where they would, in his opinion, find it easier to succeed. It was also his belief that women were suitable for the profession of landscape

architect; however, there were no educational or employment possibilities in this field in Slovenia.<sup>9</sup>

Despite the fact that Sušnik's essays were criticised by the women's newsletter *Ženski svet* (Women's World), a few years later the journalist Davorina Bevk presented a selection of typical women's professions in a very similar way. She only mentioned the vocation of architect indirectly and actually referred to the profession with a word meaning 'craftswoman.' In her opinion, it was still a very young profession that included all types of decoration and interior architecture and was very suited to women.<sup>10</sup> An equally clear insight into those times is offered by articles in the daily newspapers that reported on the renovation of the coffee shop *Zvezda* in the basement of the *Kazina* building in Ljubljana. This renovation was led in 1935 by the architect Dušana Šantel Kanoni. One of the journalists at the time wrote that some people could not come to terms with the fact that a woman had won the contract to renovate the café while another journalist claimed that 'emancipation and the equality of women and even their superiority were only admitted by their husbands at home when they are in slippers'. In renovating the café, the young architect had to fight a 'quiet but difficult battle against public opinion in order to win the confidence of the broader public.'<sup>11</sup>

### Women's Magazines in Slovenia in the 1930s and the Concept of the Modern Home

Slovenian women's magazines from the interwar period, especially the 1930s, consolidated the already very firmly rooted role of women as mothers and housewives. Along with general social and economic development, motherhood and housekeeping became increasingly demanding tasks which demanded more specific skills and experience of women - women's magazines introduced special columns and supplements which were devoted specifically to these subject matters.<sup>12</sup> This was also the case with current international women's magazines such as *Modern Women*, *Women*, *Home Chat* and *Woman's Weekly* in England as well as *Cordelia*, *Bellezza* and *Fili-modà* in Fascist

5 Jeraj, "Slovenke na prehodu," 19–37.

6 Among the teaching staff of the department of architecture-construction there were also modern oriented architects such as Dragotin Fatur (since 1926), Herman Hus (occasionally from 1923 until 1929), Josip Jelenec (from 1920 until 1923), Miroslav Kos (since 1929), Rado Kregar (from 1919 until 1927 and from 1929 forward), Stanislav Rohrman (from 1924 until 1926), Ivo Spinčič (from 1925 until 1926) and Vladimir Šubic (from 1922 until 1926). Similar schools with architecture-construction departments were opened at that time also in Belgrade, Sarajevo, Split and Zagreb. Beside the mentioned department, female students could enrol also in the applied and fine arts department, which encompassed traditionally female occupation such as ceramics design and embroidery. *Spominska knjiga: 1888–1938: Ob 50 letnici izdala Državna tehniška srednja šola v Ljubljani* (Ljubljana: Državna tehniška srednja šola, 1938), 139–143, 146–149, 263–265.

7 Archive of the Faculty of Architecture of the University of Ljubljana (AFA).

8 The legacy of Dušana Šantel Kanoni is a private collection, while the legacy of Gizela Šuklje is kept in the Museum of Architecture and Design in Ljubljana.

9 Lovro Sušnik, *Akademski poklici: Navodila za izbiro stanu* (Ljubljana: Slovensko katoliško akademsko starešinstvo, 1932), 265 and 277; Lovro Sušnik, "Ženski poklici," *Vigred: Ženski list* 14, no. 3 (1936), 112.

10 Martina Seljak [=Davorina Bevk], "Žena v različnih poklicih," in Janez Rožencvet [=Stanislav Vdovič], *Matijčkova odpravina in drugi spisi* (Gorica: Goriška matica, 1934), 60–66.

11 "Iz Ljubljane: Zvezda bo zopet oživila," *Slovenski narod*, August 10, 1935; "Zvezda bo zopet zasijala: Kavarno Zvezda bodo po načrtih arhitektke Šantlove temeljito preuredili," *Slovenski narod*, Avgust 24, 1935; "Kazini je pretila katastrofa: Kako je bila preurejena in na novo opremljena kavarna 'Zvezda'," *Slovenski narod*, December 7, 1935; "Stalna umetnostna razstava v Zvezdi," *Jutro*, December 22, 1935.

12 Women's sections were introduced also in the contemporary daily press (e.g. *Slovenec*, *Slovenski narod* and *Jutro*), and in illustrated magazines (e.g. *Domači prijatelj*). Sabina Žnidaršič Žagar, *Ženski so pa vzrasle svetlejšje dolžnosti nego kuhati in prati: Podoba in pojavnost žensk na Slovenskem: Slovenke, od sredine 19. stoletja do 2. svetovne vojne* (Ljubljana: Pedagoški inštitut, 2009), 19 and 102–103.

Italy.<sup>13</sup> Directly connected to modern housekeeping were articles about various technical appliances such as modern washing machines and vacuum cleaners, gas and electric stoves, gas and electric hot water boilers and modern refrigerators as well as innovations and articles about modern home design. Home craft features were also popular and common component of Slovenian women's magazines and as Fiona Hackney pointed out in her paper they provided women with opportunities for self-expression. They contributed to create a distinctly feminine modernity within the house and rehabilitated traditionally women's work offering them also a potential source of income.<sup>14</sup>

The authors of articles published in the Slovenian interwar women's magazines are sometimes unknown but we know that most of them were initially female journalists and later modern-thinking architects as well as the first women architects. The latter developed close ties with women's associations and their representatives and regularly collaborated with them on various occasions. A good example is the cooperation of female architects with the Union of Housewives, which organised twelve housekeeping fairs between the years 1931 and 1939 as part of the Ljubljana trade fair.<sup>15</sup> According to the journalist, Vida Lapajne, the architects provided the union with 'strong support for its work' and she was also convinced that the course of events would lead to each housewife being able to have her own expert advisor.<sup>16</sup> Journalist Pavla Hočevnar was equally enthusiastic about the cooperation of women architects and other intellectuals in preparing housekeeping fairs as in her opinion this helped give true value to the vocation of housewife which had previously been discriminated against and belittled. However, despite much enthusiasm, she also suggested that female intellectuals should use simpler and more accessible forms that simple women could understand.<sup>17</sup>

### Ženski svet (Women's World, 1923–41)

The magazine called *Ženski svet* was in circulation for eighteen years. It was first published in 1923 by the Women's Charity Association in Trieste as the newsletter of women's associations in the

region of Friuli-Venezia Giulia. When in 1928 the fascist government disbanded all Slovenian cultural organisations, the editorship of the magazine was taken over by the *Ženski konzorcij* (Women's consortium) in Ljubljana. This meant that *Ženski svet* was issued in Ljubljana from 1929 up until 1941. It was aimed at a broad circle of female readers from both urban and rural environments. When, in the 1930s, contributors to the magazine began to include people with university education, the selection of subject matters expanded and thereby gained the interest of Slovenian female intellectuals. The magazine strived on the one hand to help bring about an equal position for women in politics, work and in the social domain while on the other hand reinforcing the traditional role of a woman as mother and housewife. The chief editors of the magazine were the professor and journalist Pavla Hočevnar, the professor and journalist Olga Grahor and the journalist Milka Martelanc.<sup>18</sup>

From its very beginning, the magazine published articles which tried to inform women about modern housing culture as housewives were presented as being the guardians and souls of their homes. In this regard, we should mention also a special issue titled *Domu* ('To the Home'), published in December 1928, and a magazine supplement titled *Naš dom* ('Our home') from 1933 onwards. Women were called to meticulously care for the appearance and furnishings of the home and, in order to achieve this, they should nurture their tastes suitably and then put them into practice. The authors of different articles advised them to 'declare war' on all forged and false objects, which the nineteenth century had brought with the development of industry, and a love for old styles. They should follow the new style of the twentieth century which is most suitable for the time and its needs and at the same time, when fitting out their homes they should also include handmade products and modern design handicrafts. In the opinion of the magazine, the home would thereby become practical, simple, hygienic, harmonious and beautiful.<sup>19</sup> Some articles offer detailed descriptions of how different rooms in the modern home should be arranged and provide examples of modern folding furniture, converted old furniture as well as furniture made from practical materials. What they all have in common was their emphasis on the need for a well-considered arrangement of furniture in individual rooms and making use of the available space in an optimal way. In their opinion the walls must be lightly coloured and decorated with modern patterns. On the walls should hang only a few of the best paintings and hanging up photographs was deemed inappropriate. The windows should be of the right size with simple smooth curtains on the sides and veiled in the middle with a net curtain in a more translucent material. Lighting was also supposed to be carefully chosen with homemade lampshades to create a pleasant atmosphere in the home. The

13 To delve deeper into the matter see: Fiona Hackney, "Use your Hands for Happiness': Home Craft and Make-do-and-Mend in British Women's Magazines in the 1920s and 1930s," *Journal of Design History* 19, no. 1 (2006), 23–27; Annamaria Ruggiero, "L'immagine della donna italiana nelle riviste femminili durante gli anni del Fascismo," *Officina della Storia*, March 30, 2013, [http://www.officinadellastoria.info/magazine/index.php?option=com\\_content&view=article&id=350:limagine-della-donna-italiana-nelle-riviste-femminili-durante-gli-anni-del-fascismo&catid=68:fotografia-e-storia](http://www.officinadellastoria.info/magazine/index.php?option=com_content&view=article&id=350:limagine-della-donna-italiana-nelle-riviste-femminili-durante-gli-anni-del-fascismo&catid=68:fotografia-e-storia) (accessed February 2, 2016).

14 Hackney, "Use your Hands," 23–38.

15 The most significant housekeeping fairs were: *Novodobno gospodinjstvo* (Modern housekeeping in 1931), *Domače ognjišče* (Home hearth in 1932), *Žena in obrt* (Women and the applied arts in 1935), *Sodobna gospodinja* (Modern housewife in 1936) in *Vzorno stanovanje* (Ideal house in 1937).

16 Vida Lapajne, "Domače ognjišče' II: Gospodinjstva razstava: Zveza gospodinj," *Gospodinja* 1, no. 5–6 (1932), 35–37.

17 Pavla Hočevnar, "Vtisti in misli pri 'Domačem ognjišču'," *Ženski svet* 10, no. 10 (1932), 298–302.

18 Katja Mihurko Poniž, "Odkar dobivam Ženski svet ne poznam več malodušnosti," *Vse za zgodovino* 16, no. 22 (2009), 118–132.

19 D. D-ova, "Iščimo lepoto tudi doma," *Ženski svet* 1, no. 2 (1923), 38–40; Milica Schaupova, "Moderna soba," *Ženski svet* 8, no. 8 (1930), 245–249.

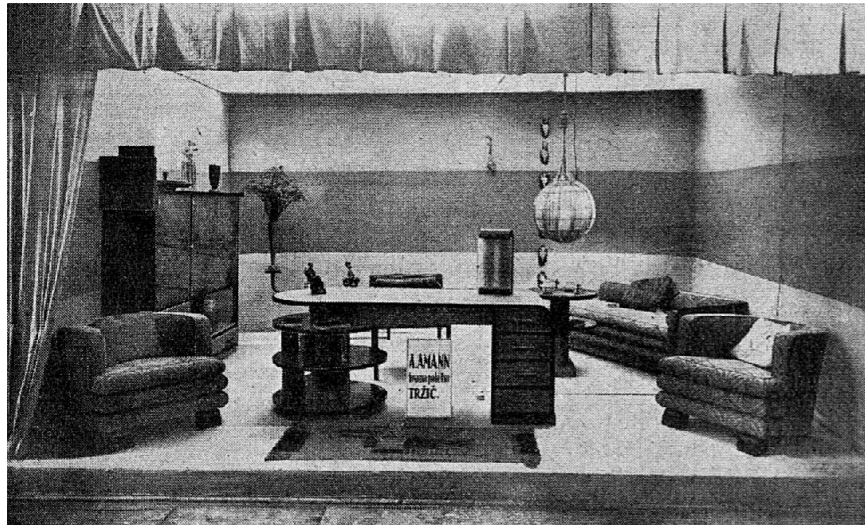

Fig.1. Furniture of the gentleman's room designed by Herman Hus and made by the Alfred Amann furniture factory from Tržič at the Ljubljana fair exhibition. Published in *Ženski svet* 8, no. 12 (1930), 397.

modern working woman was supposed to furnish her one-bedroom flat (which she is increasingly striving to obtain on her path to independence) according to the same principles.<sup>20</sup>

In the 1930 and 1931 editions of *Ženski svet* we come across the usual articles but also articles by the modern architect Herman Hus entitled The gentleman's room and Middle-class home design.<sup>21</sup> The first one was published in the thematic issue of *Ženski svet možu* ('Women's world to the husband'), which contained various texts and personal stories which spoke about the relationship between men and women and the differences between the male and female worlds. Herman Hus carefully explained to readers the man's need for a special private room in the house, the so-called gentleman's room. It was intended for him to be able to work there without being disturbed. He therefore recommended that the room be somewhat removed from the main living quarters and especially the kitchen and children's room. It should also be airy and well-lit. Its furnishings would be different depending on the needs or profession of the gentleman, however, he considers the table and chair to be essential and indispensable. He placed great emphasis on how the walls were painted, how the room was lit and small decorative objects such as paintings, statues, handicraft products and plants. For a better understanding, the article was accompanied with his sketches of modern items of furniture (writing tables, bookcases, smoking tables with armchairs, ottomans) and a photo from the Ljubljana fair with a presentation of the furniture of the gentleman's room made by the Alfred Amann furniture factory from Tržič (Fig. 1).<sup>22</sup> In the second article, Hus wrote about the middle-class apartment which, at the time, usually encompassed three rooms. It was divided

20 Vida P., "Vsaj lastno sobo," *Ženski svet* 6, no. 12 (1928), 363–367.

21 Herman Hus (1896–1960) graduated in 1927 with Ivan Vurnik at the Technical Faculty of the University of Ljubljana. He led an architectural office at Gregorčičeva street no. 19 in Ljubljana. *Spominski almanah slovenskih strokovnih pisateljev, publicistov in projektantov* (Ljubljana: Delniška tiskarna, 1940), 288; *Adresar mesta Ljubljane in okolice* (Ljubljana: Tiskarna grafika, 1933), 505.

22 Herman Hus, "Soba za gospoda," *Ženski svet* 8, no. 12 (1930), 394–397.

into the sleeping part (the children's bedroom and the parents' bedroom) and the daytime part (the living-room whose function was both a dining room and drawing room). It was furnished with simple furniture which Hus described in detail and presented clearly with the help of photographs of a modern glass cupboard made to his own design with a smoking table and two pouffes, as well as photos of an extendable square table with three chairs.<sup>23</sup>

The first female architecture graduates began working with the magazine after 1932. Dušana Šantel Kanoni first published a report in the magazine on an exhibition at the Ljubljana fair entitled 'The Woman in Slovenian Art' in which she presented the life of the painter Ivana Kobilica in the permanent column entitled 'Faces and Souls', and she designed the magazine cover in 1933.<sup>24</sup> Her colleague Marjanca Kanc Čuček prepared a critical review of the art exhibition entitled 'Slovenian Madonnas'.<sup>25</sup> In 1935, the two architects tackled some more demanding architectural subjects. In the same year they were joined by architect Gizela Šuklje.<sup>26</sup> Compared with Hus' articles, which acquainted readers with the modern furnishings of a middle-class apartment, these two architects tried to broaden the horizons of readers by discussing the furnishings of a working class flat and the layout of a village settlement. They devoted most attention to the rural house as architects had not even touched upon this theme until then<sup>27</sup> drawing attention to various deficiencies of contemporary rural houses which did not meet modern social and hygiene standards. Dušana Šantel Kanoni prepared a special feature on making inns in rural houses for the needs of rural tourism, in response to the implementation of a law from 1930 to support the restoration of villages<sup>28</sup> which set a whole list of conditions for the working of architects in villages. This law was supported by

23 Herman Hus, "Ureditev meščanskega stanovanja," *Ženski svet* 9, no. 4 (1931), 117–119.

24 Dušana Šantel Kanoni (1908–1988) graduated in 1932 with Ivan Vurnik at the Technical Faculty of the University of Ljubljana. Thanks to a French fellowship she could study at the *École Nationale Supérieure des Arts Décoratifs* in Paris between 1933 and 1934. After her return home, she intensively collaborated with various contemporary Women's magazines and used to work as interior designer. Igor Longyka and Herta Žagar, *Umetniška družina Šantel s predniki in potomci* (Slovenska Bistrica: Zavod za kulturo, 2012), 25. For more information about the mentioned article see: Dušana Šantel Kanoni, "Žena v slovenski umetnosti," *Ženski svet* 10, no. 10 (1932), 293–296.

25 Marjanca Kanc Čuček (1909–?) graduated in 1933 with Jože Plečnik at the Technical Faculty of the University of Ljubljana. She intensively collaborated with various contemporary Women's magazines and used to work, as far as we know, as an independent architect. *Spominski almanah*, 291. For more information about the mentioned article see: Marjanca Kanc Čuček, "Velesejemska razstava 'Slovenske madone'," *Ženski svet* 11, no. 10 (1933), 226–228.

26 Gizela Šuklje (1909–1994) graduated in 1932 with Jože Plečnik at the Technical Faculty of the University of Ljubljana. Thanks to a French fellowship she could study at the *Institut d'Art et Archéologie* of Paris-Sorbonne University and worked in the studio of August Perret. After her return home, she became a devoted assistant and collaborator of her prof. Jože Plečnik. Bogo Zupančič, "Predstavitev zapuščine arhitektke Gizele Šuklje (1909–1994)," *Zavod za prostorsko kulturo Trajekt*, <http://trajekt.org/arhiv/?tid=1&id=1197> (accessed February 2, 2016).

27 Gizela Šuklje, "Stanujmo v stanovanjih," *Ženski svet* 13, no. 12 (1935), 268–269; Dušana Šantel Kanoni, "Delavsko stanovanje," *Ženski svet* 13, no. 12 (1935), 275–276. The statement of women's architects is not accurate. In 1934, an architecture exhibition of modern rural farm houses and buildings as well as plans of village settlements at Ljubljana fair was organized.

28 For more detailed information, see the official gazette of the Drava Banat *Službeni list Kraljevske banske uprave Dravske banovine* (Ljubljana: Kraljevska banska uprava Dravske banovine, 1930), 677–679.

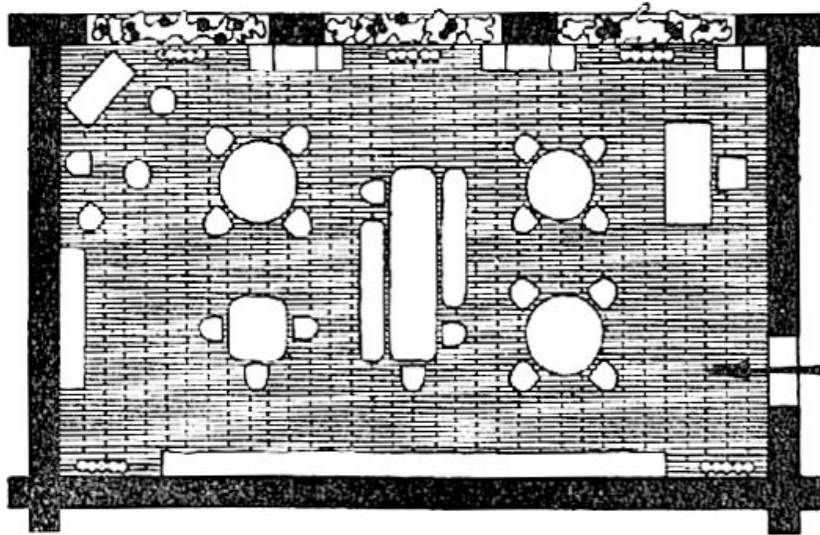

Fig.2. Gizela Šuklje, Design of a 'Happy hearth' (activity centers for children with small libraries and reading rooms where they could be freely creative). Published in *Ženski svet* 13, no. 2 (1935), 41.

various efforts by the Drava Banovina, municipalities, farming associations, professional clubs and cooperatives for the regulation of villages. Šantel concluded her article by saying that she has made readers aware of the need for prudence regarding the construction of new farmhouses in existing villages and the need to protect and preserve the 'aesthetic values of our villages' and to achieve 'harmony between the building and the landscape' with typical farmhouses that were made to suit each particular region.<sup>29</sup> Gizela Šuklje supplemented Dušana's articles with a detailed analysis of the existing problems of rural homes and she recommended the farmhouse the use of locally available material and a construction that is as solid as possible for the successful renovation based on a certain building type. In her opinion, farmers would benefit from the advice of experts and recommended that practical studies of farming houses be included in the training of technicians and architects.<sup>30</sup>

The article entitled "Metal furniture" by Dušana Šantel Kanoni is also directly connected with the theme of modern home design. She outlined the different advantages of metal furniture while drawing attention to the fact that in Slovenia the industrial production of such furniture is lagging behind but that this should not have a negative effect on its being purchased by cafes, pubs, hotels and businesses.<sup>31</sup> Somewhat outside the context of modern living culture, but directly connected with the motherly role of the woman in society, is the article by Gizela Šuklje entitled 'Veselo ognjišče' ('Happy hearth') in which she presented the activities of the *Enfance et Jeunesse* – a French organization which set up activity centres for children with small libraries and reading rooms where they freely could be creative. The author also offered readers a plan for such institutions and

29 Dušana Šantel Kanoni, "Naša vas in arhitekt," *Ženski svet* 13, no. 7/8 (1935), 168–170.

30 Gizela Šuklje, "O izboljšanju naše kmetijske hiše," *Ženski svet* 13, no. 12 (1935), 276–278.

31 Dušana Šantel Kanoni, "Kovinstvo pohištvo," *Ženski svet* 13, no. 12 (1935), 278–279.

expressed the wish that soon 'happy hearths' would also come alive in Slovenian towns (Fig. 2).<sup>32</sup>

The collaboration of the above mentioned architects with the magazine *Ženski svet* continued until 1939. Despite a promising beginning, their contributions no longer had anything to do with architectural content but were limited to reviews of contemporary art-historical and ethnographic books, evaluations of art exhibitions and presentations of some Slovenian female artists.<sup>33</sup>

### *Žena in dom* (Women and Home, 1930–41)

The monthly *Žena in dom*, which was published in Ljubljana between 1930 and 1941, was to some extent a rival for the magazine *Ženski svet*. Its editors were Erna Podgornik, Rija Podkrajšek and Tončka Lipoglavšek. Despite the fact that it tried to be a monthly for women of all social levels, its varied content mainly appealed to middle-class women. It brought readers educational and entertaining articles on the theme of housekeeping, raising children, health, hygiene, handicrafts, fashion and modern living culture. The graphic appearance of the magazine was very different from that of *Ženski svet* as the cover usually sported lively colours in combination with large format photographs, while the magazine's interior featured many photographs and images that illustrated different articles or were part of numerous advertisements for products and services by local and foreign brands.<sup>34</sup>

From the outset, the theme of modern living culture was present in the magazine and in comparison with *Ženski svet*, it focused on slightly different and more varied presentations of interior design. Whole-page photographs of furniture, which thereby became an advertisement for the woodworking company that produced it, were sometimes featured on the front cover (October 1930, June 1931, September 1932 and September 1933) or as part of advertisements for local master carpenters from Ljubljana and its surroundings in the magazine (Fig. 3). Advertisements were usually a combination of photographs of furniture and catchy slogans. These encouraged readers to buy attractive, modern, practical and solid furniture of all kinds with which buyers could comfortably and tastefully furnish their home.

Of the vast majority of articles dealing with contemporary housekeeping, their authors remain

32 Gizela Šuklje, "Veselo Ognjišče," *Ženski svet* 13, no. 2 (1935), 41–42.

33 Gizela Šuklje, "Dr. France Stele: Umetnost Zapadne Evrope," *Ženski svet* 14, no. 9 (1936), 206–207; Gizela Šuklje, "Jože Karlovšek," *Ženski svet* 14, no. 12 (1936), 273–274; Gizela Šuklje, "Jože Karlovšek: Slovenski ornament, ljudski in obrtniški izdelki," *Ženski svet* 15, no. 7/8 (1937), 182–183; Marjanca Kanc Čuček, "Jože Karlovšek: Umetnostna obrt," *Ženski svet* 16, no. 7/8 (1938), 180–181; Dušana Šantel Kanoni, "Slikarica Henrika Šantel," *Ženski svet* 18, no. 4 (1940), 73–77; Dušana Šantel Kanoni, "Razstava likovnih umetnic v Ljubljani," *Ženski svet* 18, no. 1 (1940), 20–21.

34 Mateja Ratej, "(Ma)Rija Podkrajšek - urednica mesečnika Žena in dom v letih 1930–1941," *Kronika: Časopis za krajevno zgodovino* 50, no. 1 (2014), 133–114.

unknown. Usually the articles consisted of short explanatory texts and sketches or photographs of the interiors or individual items of furniture. There were particularly interesting articles in which male readers were given practical advice in words and pictures about how they can renovate old or used furniture and, in a very simple way, give it new modern shapes or adapt it for new uses (Fig. 4).<sup>35</sup> In a similar way, they also presented articles about local handicraft products (e.g. modern designs for carpets, lampshades, pillows, curtains) that women could make themselves with the help of examples and instructions (Fig. 5).<sup>36</sup> There are also interesting articles from 1939 and 1940 which introduced relatively new themes for readers about the necessity of arranging the garden around the house with comfortable outdoor furniture for enjoying nature, about procedures for buying and building so-called weekend houses in order to spend time away from the city and about the characteristics of furnishings for modern wooden houses.<sup>37</sup>

Modern housing culture was dealt with in word and image by architects Janko Omahen,<sup>38</sup> an unknown architect M. and another unknown academic architect I. Žak. Janko Omahen was the first to begin working for the magazine. The particularity of his articles lay in the fact that they were not aimed solely at female readers but also tried to reach a male readership. In his first article from 1930 he presented the problems of modern interior design with architects belonging to one of two possible groups either in a 'technically meaningful arrangement



Fig. 3. Front cover of the women magazine *Žena in dom* (Women and home). Published in *Žena in dom* 4, no. 9 (1933).

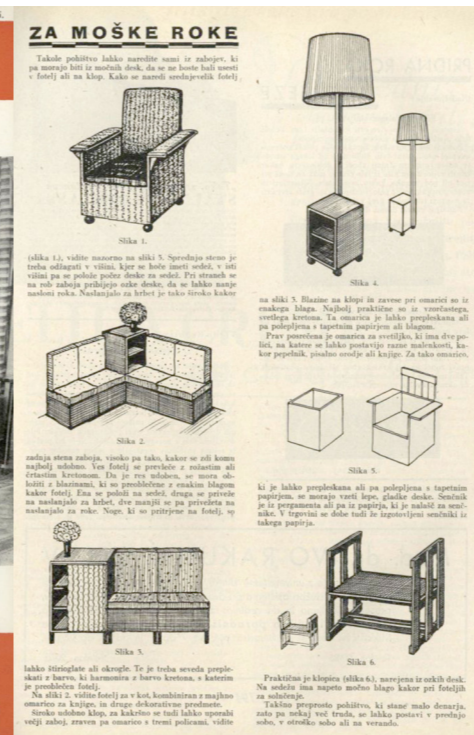

Fig. 4. 'For Men's hands' (practical advice on how can a man make modern furniture on his own). Published in *Žena in dom* 4, no. 5 (1933), 193.



Fig. 5. 'Practical handwork' (modern designs for carpets). Published in *Žena in dom* 5, no. 1 (1934), 37.

35 "Iz starega pohištva nove oblike," *Žena in dom* 1, no. 9 (1930), 306-307; "Za moške roke," *Žena in dom* 4, no. 1 (1933), 19-20; "Za moške roke," *Žena in dom* 4, no. 5 (1933), 193; "Za moške roke," *Žena in dom* 5, no. 5 (1934), 194-195; "Prenovite si opravilo," *Žena in dom* 7, no. 12 (1936), 428-430; "Iz starega novo," *Žena in dom* 8, no. 6 (1937), 248. The topic of "Make-do-and-Mend" is analysed also by Fiona Hackney in the already cited article: Hackney, "Use your Hands," 23-38.

36 E.g. "Moderno okno," *Žena in dom* 1, no. 4 (1930), 132-133; "Posteljno perilo," *Žena in dom* 5, no. 1 (1934), 35, and "Praktično ročno delo," *Žena in dom* 5, no. 1 (1934), 37; "Takale preproga napravi sobo toplo in domačo," *Žena in dom* 6, no. 6 (1935), 234.

37 "Kako si uredimo vrt?," *Žena in dom* 10, no. 3 (1939), 102-104; "Krog in krog je vrt v cvetju," *Žena in dom* 10, no. 6 (1939), 234-236; "Za letovanje: lastno hišico," *Žena in dom* 10, no. 5 (1939), 194-196, and "Med lesenimi stenami, pod lesenimi stropi," *Žena in dom* 11, no. 2 (1940), 70-71.

38 Janko Omahen (1898-1980) graduated in 1927 with Ivan Vurnik at the Technical Faculty of the University of Ljubljana. Between 1925 and 1929 he led, together with architect Domicijan Serajnik, the graphic department of the Delniška tiskarna printing house in Ljubljana. In 1929, the two architects jointly established an architectural studio and mainly dedicated their work to interior design. France Stele, "Omahen, Janko (1898-1980)," in *Slovenska biografija*, <http://www.slovenska-biografija.si/oseba/sbi395254/> (accessed July 21, 2015).

of the home' or an 'artistically-comfortable' solution. In the opinion of the author, the correct approach was the unification of both which was gradually supposed to bring about the 'harmony of a new style'.<sup>39</sup> An article from 1931 dealt with the importance of the correct selection and fitting of lighting in the home which should not be overlooked if people wished to create a 'true home'.<sup>40</sup> His last article from 1932 was a kind of justification of modern housing culture. Omahen tried to refute the main objection given by the large population that rejected the introduction of a modern style and proceeded to describe its advantages and attractiveness.<sup>41</sup> In 1933, the architect M. presented housewives with a detailed presentation of a practically and meaningfully arranged kitchen which had to include a modern kitchen table that was also depicted in sketches (Fig. 6). In 1937, an article was published by I. Žak in which he described different ways of sitting and the importance of comfort and suitable furniture.<sup>42</sup>

Female journalists only published a few articles on the subject of modern living culture. Two articles that are worth mentioning are by editor Rija Podkrajšek. She wrote about the incursion of modern style resulting in the tasteless construction of rural farmhouses and her appeal to her 'compatriots

39 Janko Omahen, "Problemi moderne ureditve prostora," *Žena in dom* 1, no. 10 (1930), 361.

40 Janko Omahen, "O lučih," *Žena in dom* 2, no. 6 (1931), 220.

41 Janko Omahen, "Sodobna stanovanjska kultura," *Žena in dom* 3, no. 9 (1932), 318-319.

42 M., "Kuhinjska miza," *Žena in dom* 4, no. 9 (1933), 330; I. Žak, "Kako sedimo," *Žena in dom* 8, no. 5 (1937), 196-197.

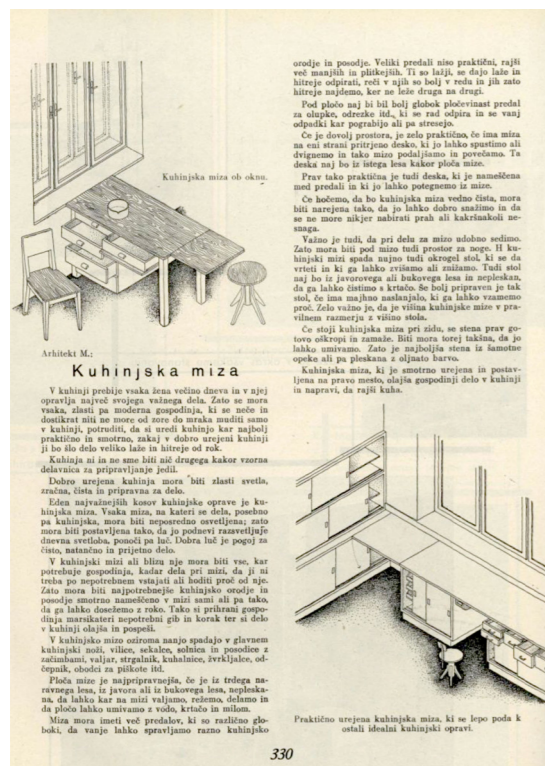

Fig. 6. Architect M., Design of a kitchen table. Published in *Žena in dom* 4, no. 9 (1933), 330.

on farms' and Slovenian rural housewives to build and equip their farmhouses in the autochthonous, Slovenian style.<sup>43</sup> After a few years, an article by an unknown female author was published about contemporary furniture along with many photographs.<sup>44</sup> Another article, also by an anonymous author, used words and pictures to present an attractive layout for an attic room.<sup>45</sup>

Women architects did not contribute articles to *Žena in dom*, but Dušana Šantel Kanoni collaborated with the magazine in a slightly different way. From 1933 onwards, she prepared stylish samples for various handicrafts for the supplement *Za pridne roke* ('For hardworking hands'), and in 1939 she wrote a handbook published by the magazine entitled *Kako opremim stanovanje* (How to furnish the home) (Fig. 7). The book came about following the initiative of magazine readers above all with the purpose of becoming a 'practical manual and sincere guide to all who would like to have an orderly and attractive home.' It was aimed, particularly, at those people who could not afford to equip their homes in a luxurious way, such as clerks, workers and farmers. In the introduction, Šantel Kanoni presented the characteristics of homes in past times, criticised old-fashioned furnishing styles and openly campaigned for modern styles. Further on, she described the main characteristics of a modern style and described different items of furniture. She paid particular attention to the layout and placing of furniture. Then there were two chapters devoted to the children's corner and holiday rooms in the countryside in Slovenian traditional style. The last part of the manual is devoted to explaining the role of the architect in fitting out the home and provides practical advice for moving. In compiling the book, Šantel Kanoni largely made use of Slovenian pictures. She featured drawings and photographs that had already been published by *Žena in dom*, as well as unpublished images of contemporary furniture which had been made according to plans drawn up by the workshop of Janez Omahen

and Domicijan Serajnik, and architects Ciril Tavčar and Dušana. Frequent references to foreign sources<sup>46</sup> in her text showed her worldliness and capability of adapting foreign ideas to the Slovenian context.<sup>47</sup>

### *Gospodinja* (Housewife, 1932–42)

The Union of Housewives was founded in 1931 as a special department of the General Women's Association in Ljubljana. In 1935 the Union became an independent association. As the Union wanted to train women to carry out the 'strenuous and responsible' work of housewives, it organised numerous educational courses, factory visits, lectures, the already mentioned housekeeping exhibition at Ljubljana's fair and published a monthly housekeeping review called *Gospodinja*. Its first editor was Albina Travnova who was succeeded later by Anica Kropivnik. It was meant for middle-class housewives as well as farming and working-class women. The main goals of the review were to obtain recognition for the life and vocation of housewives and to develop it and improve it.<sup>48</sup>

The graphic appearance of the magazine was simple but the same for all issues. It partly changed with the introduction of a new cover for the third issue in 1937 and this form was then kept until the end of 1941. Advertising was limited solely to the first and last pages of each issue and was less obtrusive than that in *Žena in dom*. There were permanent columns in *Gospodinja*. Novelties about modern living culture were brought by the column entitled 'Home' whose name was changed to 'Homeliness and comfort' after 1936. In comparison with the two magazines mentioned above, the



Fig. 7. Cover of the book *Kako opremim stanovanje* (How to furnish the home) by Dušana Šantel Kanoni.

46 She often mentioned architect Carl Burckhard and his book *Gutes und Böses in der Wohnung* (Leipzig: Verlag Otto Beyer, 1933), architect André Lurcat and his book *Architecture* (Paris: Au Sans Pareil, 1929), prof. Adolf G. Schneck and his books *Die Konstruktion des Möbels* (Stuttgart: Julius Hoffmann Verlag, 1932) and *Die Möbel als Gebrauchsgegenstand* (Stuttgart: Julius Hoffmann Verlag, 1929), prof. Ernest Neufert and his book *Bauentwurfslehre* (Berlin: Bauwelt Verlag, 1936), architect Bruno Taut and his book *Die neue Wohnun: Die Frau als Schöpferin* (Leipzig: Verlag von Klinkhardt & Biermann, 1924).

47 Dušana Šantel Kanoni, *Kako opremim stanovanje* (Ljubljana: Žena in dom, 1939), and "Inž. arh. Dušana Šantel Kanoni: Kako opremimo stanovanje," *Slovenec*, May 11, 1939, Kulturni obzornik.

48 Minka Kastelčeva, "Organizacija gospodinj drugod in pri nas," *Gospodinja* 1, no. 3 (1932), 17–18, and "10 let strokovnega gospodinjkega lista," *Jutro*, February 17, 1941.

43 Rijja Podkrajšek, "Nekaj o kmetijskem domu," *Žena in dom* 1, no. 1 (1930), 16 and Rijja Podkrajšek, "V kmetijski domove slovenski slog," *Žena in dom* 1, no. 2 (1930), 16.

44 "O sodobni opremi," *Žena in dom* 4, no. 9 (1933), 325–329.

45 "V mojem domu je domačnost," *Žena in dom* 9, no. 5 (1938), 195.

articles on this subject in *Gospodinja* were more numerous and varied in content. Most of them were written by university educated authors: up until 1934 there were contributions by architect Dragotin Fatur<sup>49</sup> and after 1935 by the architects Dušana Šantel Kanoni, Gizela Šuklje, Katarina Grasselli<sup>50</sup> and Marjanca Kanc Čuček as well as the university educated gardener Ružica Barle. Developments in contemporary housekeeping were followed by the column 'Technology' which brought housewives various news about ground-breaking technical innovations in the field of housekeeping such as modern washing machines and vacuum cleaners, gas and electric stoves and gas and electric hot water boilers. There are also some interesting articles in the Economics and Healthcare sections, which discussed the problem of working class and rural housing in Ljubljana and its nearby surroundings.

Contributions by architect Dragotin Fatur can be divided into two content groups. The first group contains articles of a more theoretical nature in which the author has tried to address housewives directly by inviting them to consider new findings about modern living culture.<sup>51</sup> The other group features articles that are more of a practical nature, in which he tells readers how to furnish individual rooms in middle-class houses (family or living rooms, bedrooms, bathrooms and separate toilets and laundry rooms). He offered advice on how to build one's own home, explained the beneficent effects of moving, described what new materials were available on the market (such as rubber flooring and wallpaper), showed possibilities for furnishing the modern apartment, for example through wall paper and wall panelling, and spoke about the importance of a good home and garden design.<sup>52</sup> The articles also reflect Fatur's special relationship with housewives. He believed that the housewife is the centre of the family and that she must not assume the traditionally subordinate role but a leading one. She should play a decisive role in preparations for the construction of the family home. She should cooperate closely with the architect and let him or her know her needs and wishes, which, however, should not surpass the family's financial capacities.<sup>53</sup>

The rich selection of articles by Slovenian women architects in *Gospodinja* can be divided into different themes. The first, articles in which women architects publish modern home design with detailed descriptions of the layout of individual rooms (the anteroom, dining room, living room/lounge, bathroom, bedroom).<sup>54</sup> The structure and content of these articles was similar to those by Fatur. Besides the usual description of the function of a particular room, its position, equipment, recommended interior design of walls, ceiling and floor, and possible artistic or handmade objects, architects often included in their texts a short historical overview of the development of an individual room with details about the contemporary situation in Slovenia. There was a special chapter on the layout and equipment of a modern kitchen, which Gizela Šuklje and Dušana Šantel Kanoni both dealt with in depth.<sup>55</sup> Although their two articles were similar in many ways, Šantel Kanoni's article offered an even deeper analysis and included technical details about minimal measurements of existing typologies of kitchen and about the latest acquisitions and innovations in this field. Both texts showed that their authors had broad horizons and were aware of contemporary developments in other countries. Šuklje's article was also accompanied by an illustrated supplement from the book called *Stanovanje* (Apartment)<sup>56</sup> which showed the layout of the so-called Frankfurt Kitchen (1926, designed by Margarete Schütte-Lihotzky) and the two-part kitchen sink. A special group of articles in *Gospodinja* dealt with Slovenian handicrafts and arts, which in the architects' opinion, gained in value and in price after the war (Fig. 8). Their use in the modern apartment was completely justified as long as they were used with moderation and with feeling. They gave the home the very necessary warmth and an original touch.<sup>57</sup> The use of fresh flowers was also very appropriate for decoration as was fresh greenery, which Katarina Grasselli wrote about. Gizela Šuklje delved into the meticulous arrangement of the small garden characterised by simple and clear lines in which plants are left to grow freely, while Ružica Barle explained the characteristics of rockeries

49 Dragotin Fatur (1895–1973) graduated in 1924 with Jože Plečnik at the Technical Faculty of the University of Ljubljana. In the interwar period, he established an architectural studio and worked as a professor in the technical secondary school in Ljubljana. He was the main editor of the first Yugoslav architectural magazine *Arhitektura* (1931–34).

50 Katarina Grasselli (1910–1990) graduated in 1934 with Jože Plečnik at the Technical Faculty of the University of Ljubljana (AFA). Her interwar work is still mostly unknown.

51 Dragotin Fatur, "Stanovanjska kultura," *Gospodinja* 1, no. 3 (1932), 18–19; Dragotin Fatur, "Stanovanje in oprema," *Gospodinja* 2, no. 10 (1933), 75–76; Dragotin Fatur, "Udobno stanovanje," *Gospodinja* 2, no. 9 (1933), 70–71; Dragotin Fatur, "O pohištvu," *Gospodinja* 3, no. 3 (1934), 27–28.

52 Dragotin Fatur, "Družinska soba," *Gospodinja* 2, no. 1 (1933), 2–4; Dragotin Fatur, "Spalnica," *Gospodinja* 2, no. 2 (1933), 10–11; Dragotin Fatur, "Kopalnica, umivalnica, stranišče," *Gospodinja* 3, no. 9 (1934), 98 and *Gospodinja* 3, no. 10 (1934), 110; Dragotin Fatur, "Pralnica," *Gospodinja* 4, no. 6 (1934), 63–64; Dragotin Fatur, "Pogoji za gradnjo lastnega doma," *Gospodinja* 2, no. 6 (1933); Dragotin Fatur, "Selitev," *Gospodinja* 3, no. 2 (1934), 16–17, 43–45; Dragotin Fatur, "Kavčuk," *Gospodinja* 3, no. 8 (1934), 88–89; Dragotin Fatur, "Stene stanovanja: Tapete," *Gospodinja* 3, no. 1 (1934), 2–3; Dragotin Fatur, "Opločevanje sten," *Gospodinja* 3, no. 4 (1934), 39–40, and Dragotin Fatur, "Hiša, stanovanje, vrt in človek," *Gospodinja* 3, no. 5 (1934), 50.

53 Dragotin Fatur, "Arhitekt in gospodinja," *Gospodinja* 1, no. 2 (1932), 10–11.

54 Dušana Šantel Kanoni, "K smotrenemu urejevanju stanovanja," *Gospodinja* 4, no. 4 (1935), 38–39; Gizela Šuklje, "Domače ognjišče," *Gospodinja* 5, no. 8 (1936), 88; Dušana Šantel Kanoni, "Predsoba," *Gospodinja* 4, no. 7 (1935), 74–75; Gizela Šuklje, "Vestibul: Vhod v domačijo," *Gospodinja* 5, no. 10 (1936), 110–111; Gizela Šuklje, "Jedilnica," *Gospodinja* 6, no. 2 (1937), 14; Gizela Šuklje, "Hala, salon, dnevna soba: Stanovanjski in družabni prostor," *Gospodinja* 6, no. 1 (1937), 2–3; Gizela Šuklje, "Kopalnica," *Gospodinja* 6, no. 3 (1937), 26–27, and Marjana Kanc Čuček, "Spalnica," *Gospodinja* 6, no. 6 (1937), 62–63.

55 Gizela Šuklje, "Nekaj misli o oblikovanju kuhinjskega prostora," *Gospodinja* 4, no. 8 (1935), 86–87, and Gizela Šuklje, "Nekaj misli o oblikovanju kuhinjskega prostora," *Gospodinja* 4, no. 9 (1935), 98–99; Dušana Šantel Kanoni, "Kuhinja," *Gospodinja* 8, no. 4 (1939), 38; Dušana Šantel Kanoni, "Kuhinja," *Gospodinja* 8, no. 5 (1939), 51, and Dušana Šantel Kanoni, "Kuhinja," *Gospodinja* 8, no. 6 (1939), 63–64.

56 Jože Mesar and Ivo Spinčič, *Stanovanje* (Ljubljana: Jugoslovanska knjigarna, 1931).

57 Gizela Šuklje, "Zavese," *Gospodinja* 4, no. 1 (1935), 2–3; Dušana Šantel Kanoni, "Ročno delo v sodobnem stanovanju," *Gospodinja* 4, no. 2 (1935), 14–15; Gizela Šuklje, "Tkanine," *Gospodinja* 5, no. 1 (1936), 3, and Gizela Šuklje, "Tkanine v nošnji in stanovanju," *Gospodinja* 5, no. 2 (1936), 15–16; Gizela Šuklje, "Mali okraski stanovanjske opreme," *Gospodinja* 5, no. 5 (1936), 52–53;

and common mistakes made when creating them.<sup>58</sup> The new thematic group consisted of articles in which the architects Dušana Šantel Kanoni and Marjetka Kanc Čuček dealt with the question of how to create a more child-friendly home where each family arranged a children's room or small children's corner in the parents' bedroom, or if this was not possible, that readers should at least buy appropriate children's equipment (bed, table with chairs and children's cupboard) made of a light material and of a clean and simple form. According to the architect, the permanent corner and personally scaled equipment would make children feel greater attachment

to the home and would also teach them independence and a sense of orderliness (Fig. 9).<sup>59</sup> In their articles the architects dealt with a broad spectrum of homes from middle-class apartments, small working-class flats in the form of workers' colonies, terraced houses and apartment blocks in suburbs, to plans and studies of rural houses and health buildings which Yugoslavia exhibited at the *Exposition Internationale des Arts et Techniques dans la Vie Moderne* in Paris in 1937. They also dealt with a new kind of single person's flat ('bedsit'), plans and equipment for small gardens or summer houses in the countryside and offered readers practical instructions for preparing pleasant, homey rooms for tourists.<sup>60</sup>



Fig. 8. Dušana Šantel Kanoni's design for pillows, around 1935. Courtesy of Dušana Šantel Kanoni private collection (EG0007370), (published also in *Gospodinja* 4, no. 2 (1935), 15).



Fig. 9. Play kitchen designed by Dušana Šantel Kanoni, Second Housekeeping exhibition at Ljubljana's fair (1932). Courtesy of Dušana Šantel Kanoni private collection (EG0007387).

## Conclusion

The presentation and analysis of the above mentioned women's magazines, *Ženski svet*, *Žena in dom* and *Gospodinja*, has shown that during the interwar period these magazines played an important role in spreading ideas about modern housing culture amongst the female population. Each one had its own approach, but what they shared in depth was their approach to living culture. They did not limit themselves solely to presenting the traditional middle-class home but reacted well to the needs of society, which was advancing carefully along the path of general modernisation and progress. Slovenian women architects played an impor-

tant role with their articles regarding the modern solution for farmhouses and working-class housing, the correct use of contemporary handicrafts and artistic decorations and flowers in the modern home, making suitable children's furniture, and the principles of modern gardening. The architects showed a worldly and sophisticated approach to their subjects and knew much more than just what was related to interior design and home decoration. This can be seen especially clearly through a comparison with current popular articles written by women journalists focused above all on underscoring women's skills and taste within their home. Unfortunately, the advanced ideas of Slovenian women architects only reached the small number of women who read these magazines as they did not publish their articles in the daily newspapers and other specialised press, which was very common at that time in other countries, for instance in Italy.<sup>61</sup> One of the best examples of their practice, in the field of modern living culture were the items of kitchen and children's furniture by Dušana Šantel Kanoni which were on display at the housekeeping exhibition at Ljubljana's fair in 1932 (Fig. 10) and other examples of Šantel Kanoni's furniture design published in the manual entitled *How to equip your home* in 1939. Katarina Grasselli designed the garden layout of the former Villa Bahovec on Erjavčeva street 11 in Ljubljana after 1935, which was demolished in 1982 due to the construction of Cultural and Congress Centre Cankarjev dom. Marjanca Kanc Čuček planned the collective housing building on Tržaška

58 Katarina Grasselli, "Cvetlice v stanovanju," *Gospodinja* 5, no. 3 (1936), 27-28, and Katarina Grasselli, "Vrtič v stanovanju," *Gospodinja* 5, no. 4 (1936), 42-43; Gizela Šuklje, "Arhitektura malega vrta," *Gospodinja* 4, no. 5 (1935), 50-51, and Ružica Barlè, "Skalnjak in alpini," *Gospodinja* 6, no. 10 (1937), 103-104; Ružica Barlè, "Skalnjak in alpini," *Gospodinja* 6, no. 11 (1937), 115-116; Ružica Barlè, "Skalnjak in alpini," *Gospodinja* 6, no. 12 (1937), 126, and Ružica Barlè, "Skalnjak in alpini," *Gospodinja* 7, no. 1 (1938), 2-3.

59 Dušana Šantel Kanoni, "Otroško pohištvo," *Gospodinja* 4, no. 10 (1935), 110-111; Marjana Kanc Čuček, "Otrok in dom," *Gospodinja* 6, no. 9 (1937), 91-92.

60 Marjana Kanc Čuček, "Malo stanovanje," *Gospodinja* 6, no. 4 (1937), 42-43 and Marjana Kanc Čuček, "Malo stanovanje," *Gospodinja* 6, no. 5 (1937), 54-55; Gizela Šuklje, "Nekaj besedi o našem pohištvo," *Gospodinja* 6, no. 10 (1937), 103; Marjana Kanc Čuček, "Garsonjera," *Gospodinja* 7, no. 12 (1938), 127; Gizela Šuklje, "Poletna hišica," *Gospodinja* 5, no. 6 (1936), 64, and Gizela Šuklje, "Soba za letoviščarje," *Gospodinja* 4, no. 6 (1935), 62.

61 Katrin Cosseta, *Ragione e sentimento dell'abitare: La casa e l'architettura nel pensiero femminile tra le due guerre* (Milano: Tipomozza, 2000), 15.



Fig. 10. Kitchen furniture designed by Dušana Šantel Kanoni and made by Andrej Fajfar furniture factory from Bistrica-Podbrežje, Second Housekeeping exhibition at Ljubljana's fair (1932). Courtesy of Dušana Šantel Kanoni private collection (EG0007376).

street 11 in Ljubljana in front of the Tobacco factory for the sisters Karla Kanc and Štrekelj Mara around 1938.<sup>62</sup> Despite the fact that much remain unknown and that it will be necessary to carry out much more research, the content of these magazines points to the fact that the road to modernisation of living culture in Slovenia began already at the end of the twenties and that it was on a high level despite the artisanal form of production and marketed to both male and female audiences by male and female experts. However, the trends that were begun could only come alive fully after the Second World War in the context of the new socialist state and with the help of mass industrial production.

<sup>62</sup> For more information about Katarina Grasselli see: Bogo Zupančič, *Usode Ljubljanskih stavb in ljudi: 1–24* (Ljubljana: KUD Polis, 2009), 86–93. In regards to Marjanca Kanc Čuček see: "Iz Ljubljane: Sgraffiti Prof. S. Šantla," *Jutro*, September 11, 1938, and "Ljubljana: Zanimiva hiša na Tržaški cesti," *Slovenec*, September 15, 1938.

#### Alenka Di Battista

Research Centre of Slovene Academy of Sciences and Arts,  
'France Stele' Institute of Art History



Alenka Di Battista obtained a BA in History of Art and History at the Faculty of Arts of the University of Ljubljana in 2011, and for her BA thesis "Nova Gorica and Velenje: Miracles of the socialist post-war reconstruction" received the Student Prešeren Award of the Faculty of Arts in Ljubljana. Since 2011 she has collaborated with the international research project 'Unfinished modernisation', presenting the new constructed postwar cities in Slovenia, Kidričevo, Nova Gorica and Velenje'. She obtained her PhD at the Postgraduate School ZRC SAZU and became Research Assistant at the "France Stele" Institute of Art History in Ljubljana in 2017. Her research interests concern twentieth-century architectural and urban history, especially the interwar period in Slovenia and neighboring countries. For the EU MoMoWo-project she researches the interwar work of Slovenian women architects.

E-mail: [alenka.di.battista@zrc-sazu.si](mailto:alenka.di.battista@zrc-sazu.si)

## The Role of Spanish Women in the Household and Craftwork in the First Years of the Regime of General Franco: The Women's Section

After the Civil War, Franco's Dictatorship in Spain revitalized the so called Women's Section, created in 1934 as the female section of the Falange political movement. It was an organisation similar to those in Germany or Italy, which promoted the role of women as mothers and wives in accordance with the ideology of the regime.

Losing the war in 1939 implied the end of the initiatives of the Republic to dignify women, promote their access to higher education and their participation in public social activities. Franco's regime made women go back to their homes, (mostly in the first decades) making fun of republican women considering them 'tomboys' or depraved persons who wanted to subvert the biological order of housebound women. It is in this historical and ideological framework that we analyse how the Women's Section was created and how they organised training courses for women as 'home managers'. These courses aimed to train women not only in daily matters such as cooking, childcare or domestic tasks, but also in the revival of popular craftworks, decoration and furnishing as well as manual arts.

Keywords: Spain, Francoism, women, interior design, craftwork

It is not necessary to describe, as it is well known, the minor role that women played during Franco's regime in Spain (1939–75), mostly in the first part of the regime. At that point, as Simone de Beauvoir described in 1949 a woman's life was always subject to her husband. Her role was that of a secondary gender reliant on the primary, leading agent of the historical transformation: the man.<sup>1</sup> First from the Falange with the Women's Section as the enforcer, and later on with the Opus Dei in the second half of the regime, they created a feminine ideal that implied the return of women to their homes. As Capel pointed out, several campaigns were developed during the 1940s from different perspectives (church and state) enhancing the prototype of the housewife as the agent responsible for the well-being of the family because of their dedication to domestic tasks.<sup>2</sup>

The hierarchical differences between men and women implied that females were not capable of having their own view of the world, which meant they embraced the sets of values and roles that the male gender established. However, that imposition was enforced subtly, so it seemed it actually came from the subject group, women. During Franco's Regime, especially in the first decades of the postwar period, women had a relevant position, as mothers to give birth to the children of the 'New Spain', to raise those children and educate the new society of the regime. Women were considered in charge of bringing up their families, as wives and mothers. The policy aimed at raising the birth rate provided extended families with several benefits, as long as women did not work out of the house. This promotion to raise the birth rate was not only based on ideological issues, but also on a national need, as in the first period of the regime it was necessary to counteract the demographic emptiness caused by the Civil War. Similarly, the discrimination of women in the labor market somehow alleviated the unemployment rate of the 1940s and 1950s in a country devastated by the war.<sup>3</sup>

- 1 Simone de Beauvoir, *El segundo sexo* (Madrid: Cátedra, 2000). First edition in French *Le Deuxième Sexe* in 1949.
- 2 Rosa M<sup>a</sup> Capel Martínez, *Mujer y trabajo en el siglo XX* (Madrid: Arco Libros, 1999), 47.
- 3 Gloria Nielfa Cristóbal, *Mujeres y hombres en la España franquista: Sociedad, política, economía y cultura* (Madrid: Instituto de investigaciones feministas, 2003), 31.

The ideological context regarding the role of women during Franco's Regime was based on two premises<sup>4</sup>: the bourgeois model of the housewife and the model promoted by Catholicism. In the first case, it is widely known that since the Industrial Revolution took place there was a process of separation between the productive sphere (work place) and the reproductive sphere, related to domestic matters. Men belonged to the first model, and non-working women to the second, except for those women of the high bourgeoisie who had domestic servants, thus joining the two spheres. Women were then considered the 'angel of the house' and the backbone of the family stability. On the other hand, the traditional catholic discourse promoted the idea that women should be linked to the family, taking care of the house and children's education. The female model of this catholic discourse was Virgin Mary, who was the ideal of purity, service, sacrifice and modesty. Moreover, as Jesuit Enrique Herrera Oría pointed out, they had to 'educate girls in what should be the basic ambition of every woman: make the home an extension of who you are'.<sup>5</sup>

Education for women of all ages was based on transferring a culture limited to the private and domestic sphere, and their training was focused on moral education, rather than intellectual training. Those values associated with femininity were developed from early childhood, in order to create perfect housewives, devoted wives and perfect managers of their homes, while men took care of the social and political management. However, even in this female role, the daily life of women was subject to their social condition. This distribution of gender roles was only possible in the urban middle class and the high society, where ruling the house or attending formal ceremonies were part of a bourgeois ritual. In most Spanish homes lived reality was a different situation. After the war, society in Spain was mainly rural, and that prototype of the woman staying at home and taking perfect care of the house and family was only a utopia. Rural women not only took care of the house, but also of the animals and gardens, and they collaborated with their husbands in cultivating the fields.<sup>6</sup> Even in the technocratic age in the 1970s, with the exodus from rural areas to the cities, many low class women contributed to the household income carrying out all kinds of activities.

### The Women's Section and the Female Ideal in the Fascist Discourse

The Women's Section was an institution that contributed to establish the ideological discourse of Spanish women during Franco's Regime. It was led by Pilar Primo de Rivera, and it was 'the only

legal political organization for women after the war'.<sup>7</sup> It was created in 1934, a few months after the foundation of the Spanish Falange led by José Antonio Primo de Rivera, Pilar's brother. It was disbanded in 1977 after General Franco's death. It played an important institutional role as it controlled the training for women of all levels and ages. After the war, this organisation was in charge of education for girls and it had general control over women (very often in conflict with schools run by nuns, who saw the Women's Section as a rival), as opposed to the confrontations existing in the Falange. Discrepancies with the clergy were usual, in spite of their strong catholic orientation. For example, a controversial aspect was the incorporation of physical education into the academic curriculum. In order to join this type of physical activities, they created the 'pololos', a sort of baggy short trousers to be worn under the skirts, and which did not please the members of the Catholic Church.

We shall take into account that the participation of Falangist women during the war was very scarce, devoted to social and medical assistance to injured people, or to clothing, sewing uniforms and equipment that soldiers needed. However, during the Second Republic the political and social implication of women was seen as a threat, and that is why the Women's Section promoted an approach to domesticity, which implied the confinement of women in their 'natural' environment: the house, ignoring the different duties women carried out inside the family unit, especially in the rural areas. That domestic ideology actually entailed that women had to go back to the private sphere. Since the end of the Civil War, the training on which the Women's Section relied promised that soldiers coming back home would have 'such a pleasant family life, that they would find anything they may want inside their homes, so they would have no need to look for anything in taverns and casinos in their free time'.<sup>8</sup>

Its main role was instructing young women to be good mothers and wives. This type of pedagogy was disseminated among *Escuelas de Hogar* (Domestic Schools), *cátedras ambulantes* (Travelling Professorships) and the Social Service compulsory for women, which were, all in all, training courses on matters related to maternity and domestic subjects. As Álvarez Puga stated, most of the activities of the Women's Section had to do with household tasks, in line with all the fascist ideologies which relegated women to the domestic sphere.<sup>9</sup> The 3 k's German slogan: 'Kinder, Küche, Kirche' (children, kitchen, church) which encouraged women to embrace the traditional way of life, and which Hitler would later on take up, was imitated with the 3 c's 'casa, cocina, calceta' (house, kitchen, knitting).<sup>10</sup> The Women's Section found a similar model in the *Fasci Femminili* in Italy or in the *Mocidade Feminina* in Portugal, which had identical propaganda lauding female reproductive roles and

4 Jordi Roca i Girona, "Esposa y madre a la vez. Construcción y negociación del modelo ideal de mujer bajo el (primer) franquismo," in Gloria Nielfa Cristóbal (ed), *Mujeres y hombres en la España franquista: Sociedad, economía, política, cultura* (Madrid: Editorial Complutense, 2003), 50–51.

5 Enrique Herrera Oría, "Educar en la niña a la mujer," *Atenas* (December 1938), 366.

6 Matilde Peinado Rodríguez, *Enseñando a señoritas y sirvientas: Formación femenina y clasismo en el Franquismo* (Madrid: Catarata, 2012), 44.

7 Lourdes Benería, *Mujer, economía y patriarcado durante la España franquista* (Barcelona: Anagrama, 1977), 19.

8 "La gran concentración femenina de Medina del Campo," *Revista Y* (June 1939).

9 Eduardo Álvarez Puga, *Diccionario de la Falange* (Barcelona: Dopesa, 1977).

10 Victoria Sau, *Diccionario ideológico feminista* (Barcelona: Icaria Editorial, 1981), 165.



Fig. 1. Meeting of Pilar Primo de Rivera with the Nazi Women in 1941 in Berlin. Courtesy of Bundesarchiv Bild 146-1976-112-03A, October 1941.

showing women as mothers of the children of the nation and also sharing the same concerns about gymnastic activities.<sup>11</sup>

The fascist component in the first years of Franco's Regime was obvious until the Second World War broke out. As in other authoritarian European regimes (Italian and German) the Spanish Government relied on a strong repression, using attractive rhetoric pretending to be the saviors of the civilization, and even showing a fake desire to encourage the masses to participate in the political decisions of the nation. Some gender issues also present great similarities among Italian Fascism, German Nazism and Francoism: policies aimed at raising the birth rate, patriarchal family structure, the promotion of the home and maternity, exclusion of women from the labor market.<sup>12</sup> Likewise, the three regimes had their own women's organizations, as the German *Nationalsozialistische Frauenschaft* and *Deutsches Frauenwerk*, which were the model that the Women's Section followed in many aspects. We know of 16 trips by a delegation of the Women's Section to Germany, in addition to the stay in Spain of six groups of *Bund Deutscher Mädel* (Fig. 1).<sup>13</sup> In September, 1941, the leader of the Women's Section Pilar Primo de Rivera travelled to Germany where she was welcomed by Adolf Hitler whom she gave a sword and a dagger elaborated by a craftsman in Toledo,<sup>14</sup> at the request of Franco himself. Besides, there was an exchange of delegations with Italy, although it was less relevant than the one

11 Giuliana di Febo, "La condición de la mujer y el papel de la iglesia en la Italia fascista y en la España franquista: Ideologías, leyes y asociaciones femeninas," in *Ordenamiento jurídico y realidad social de las mujeres: Siglos XVI a XX* (Madrid: Seminario de Estudios de la mujer Universidad Autónoma de Madrid, 1986), 446.

12 Rosario Ruiz Franco, *¿Eternas menores? Las mujeres en el franquismo* (Madrid: Biblioteca Nueva, 2007), 25.

13 Antonio Morant i Ariño, "Una importante expresión de amistad hispano-alemana: Les visites de Pilar Primo de Rivera a l'Alemanya nacionalsocialista, 1938-1943," in *I Encuentro de Jóvenes Investigadores en Historia Contemporánea de la Asociación de Historia Contemporánea* (Zaragoza: Prensas Universitarias de Zaragoza, 2008), 2.

14 During the visit to Germany she was received by different Nazi leaders to 'offer a clear vision of the attention that the Nazi policy has dedicated to the feminine'. *Revista Y* (Mai 1938).

with Germany. As in other contemporary regimes, Francoism aimed to instill the values and way of life that followed the model of a fascist society, which implied women were to serve their husbands, and become 'perfect maids' whose final goal was no other than 'improve the family life'.<sup>15</sup>

### Domestic Activities and the Household for the Women's Section

The organisational structure of the Women's Section consisted of National Schools, Residence Halls, Farm Schools, craft workshops, Domestic Schools, lodgings, press and propaganda, publications (as the journals *Y*, *Teresa* or *Bazar*), Vocational Training Schools, Social services, Nursing Schools, etc.<sup>16</sup> The Domestic Schools seemed to imitate German models and focused on the idea of the woman as the main element in the house and family and also on the need to receive theoretical and practical training for that purpose. Although back in 1941 there were fifty seven domestic schools throughout Spain, there were more than one thousand mixed schools that combined official education delivered by a teacher, and training on domestic aspects, with either one or more specific teachers.<sup>17</sup> Single-sex education offered specific courses for young girls: 'Family and social education', 'Sewing' and 'Music and songs', in addition to 'Dressmaking', 'Domestic economy and social relationships', 'Postnatal care' or 'Cookery' in advanced courses (Fig. 2).

In 1942 the Rural Domestic Schools were created thanks to a consortium with the National Institute for Colonization, which belongs to the Ministry for Agriculture. Their purpose was to keep the training program of each city, without taking women away from their environment. Part of their activities had to do with the rural environment, like the *Escuela de Economía Doméstica Rural de Aranjuez*<sup>18</sup> (Rural Domestic Economy School of Aranjuez), *cátedras ambulantes* (travelling professorships), farm



Fig. 2. Cooking classes, Barcelona, 1943. Courtesy of Merletti Collection/ IEFC Ref. ACP-1-295.

15 M<sup>a</sup> Teresa Gallego Méndez, *Mujer, Falange y Franquismo* (Madrid: Taurus, 1983), 198.

16 Carmen Alcalde, *Mujeres en el Franquismo. Exiliadas, nacionalistas y opositoras* (Barcelona: Flor del viento ediciones, 1996), 59.

17 Luis Suárez Fernández, *Crónica de la Sección Femenina y su tiempo* (Madrid: Asociación Nueva Andadura, 1993), 109.

18 The School of Aranjuez was created in 1950 for the training of rural instructors, and the following year it would become a collaborating school of the Ministry of Agriculture.

schools or rural homes in the colonial villages, in the rural areas. In addition to traditional songs and regional dances, cookery and sewing, women received training on how to be a truly good housewife, which, in a period of 45 days, included whitewashing walls, gardening arrangements, balconies, kitchen, etc.<sup>19</sup> Moreover, there were advocates of the Women's Section who visited the homes to 'make improvements' and recommended that women 'make use of their old domestic utensils or clothes'.<sup>20</sup> For traditional Spanish women in the postwar period, the fact that their role as wives (or even as mothers) could be questioned, was used by the Regime as a control measure. It is fair to imagine that housewives could fear being called into question.

In all the places where the Women's Section developed their activities, they recommended women take extreme care of their hygiene and appearance in order to 'instill the desire to strive for perfection from the very beginning, and achieve a greater refinement, thus raising the cultural level in Spain'.<sup>21</sup> It was also suggested that those places should have an austere decoration, to prevent those women 'from getting used to excessive luxury, as they could not keep up with it', but at the same time setting the example of the minimum living standards 'they should achieve in their own homes'. Likewise, women were advised to take up sewing and dressmaking as a usual activity, which also had a practical use. It seemed that sewing and dressmaking were intrinsic to females because 'every little girl loves sewing'. So from a very early age they should start sewing, firstly with a cloth to practice sewing stitches, backstitches, hems and buttonholes, being able after some to make table cloths or table linens and then practice pin stitching, laces, piping, embroidery or cross-stitching (Fig. 3).

Concerning domestic tasks, the Women's Section provided training on home cleaning and ventilation, the importance of the exposure of the house and the distribution of rooms, the furniture that was necessary for each room, natural and artificial lighting or the different heating systems (Fig. 4). There were even courses focused on Decoration, which dealt with the importance of the aesthetic of the home, decoration of walls and ceilings, distribution of rooms and how to use the available space, material and distribution of furniture, combination of fabrics and the use of decorative objects like vases, pictures or even indoor plants (Fig. 5). Interestingly, this training program included a section on how to have a little washroom inside the house to enjoy some privacy.<sup>22</sup>

The publications linked to the Women's Section suggested austerity in decoration, in line with the economic status of the country after the civil war. On the one hand, women were encouraged to take care of the domestic economy focusing on their resources and planning their needs in advance,

19 Pilar Primo de Rivera, *La Enseñanza doméstica como contribución al bienestar de la familia española* (Madrid: Comercial Española de Ediciones, 1961), 24.

20 Primo de Rivera, *La Enseñanza doméstica*, 25.

21 Falange Española Tradicionalista y de las JONS. Delegación Nacional de la Sección Femenina, *Plan de formación de las juventudes* (Madrid: Afrodisio Aguado S.A., 1946), 14.

22 Falange Española Tradicionalista y de las JONS. Delegación Nacional de la Sección Femenina, *Plan de formación de las juventudes* (Madrid: Afrodisio Aguado S.A., 1946), 184 and 198.



Fig. 3. Sewing classes, Women's Section, 1942.

Courtesy of Fondo Santos Yubero, Archivo Regional de la Comunidad de Madrid (ARCM).



Fig. 4 Home Schools, 1940.

Courtesy of Fondo Santos Yubero, ARCM.



Fig. 5. Classes at the Home School, Madrid, 1942.

Courtesy of Fondo Santos Yubero, ARCM.

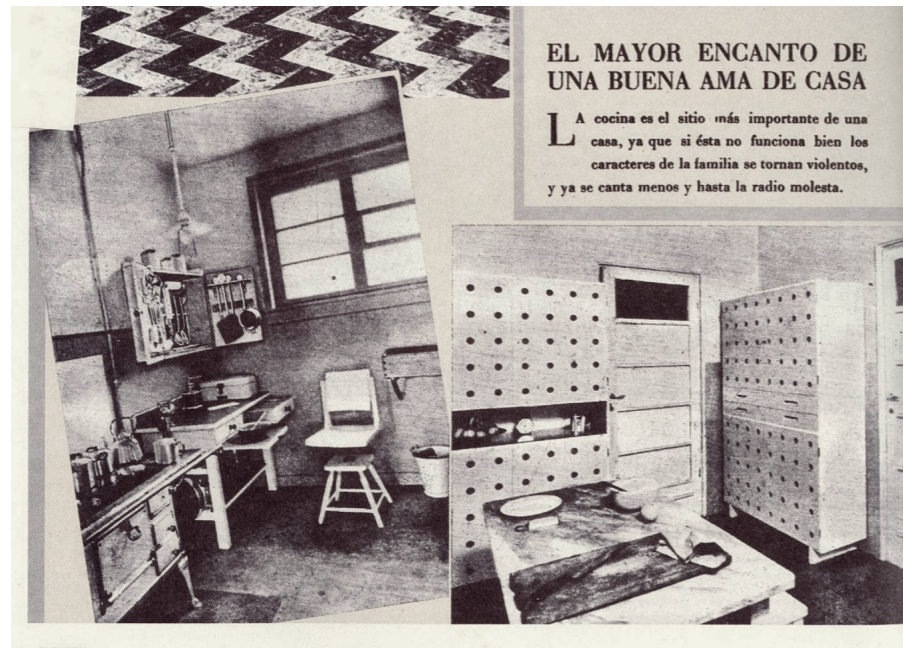

Fig. 6. The kitchen, *Medina Journal*, 1943.

especially in the kitchen, as it was considered to be a place of 'order and cleanliness, where all the family will gather and sing wonderful songs'.<sup>23</sup> On the other hand, women were also encouraged to use old furniture, as 'you may restore and rejuvenate your old-fashioned furniture yourself'<sup>24</sup> and also to make their own curtains, bed covers and tablecloths etc. which were explained on a regular basis in many women's magazines (Fig. 6). That strong orientation to take up recycling and be self-sufficient is parallel to the lack of a national industry able to fulfill the domestic needs at that time. Thus, women with all the instructions provided by the media and the training delivered by the Women's Section became decorators of their homes.

### Craftwork in the Women's Section

It is worth mentioning how the Women's Section promoted Spanish craftwork. In general, a quite large Falangist faction believed that embracing modern trends meant losing their national identity, and thought they were antinational, cosmopolitan and capitalist. As Llorente has explained, craftwork has three main values for the Falange: social and economic, as a way to increase the income of a population impoverished by the war and by the lack of industrial fabric; ideological, overlapping the anti-capitalist discourse of the Falange, as the promotion of artisans was contrary to the foundations of capitalism, with an interesting religious connection, because the spiritual mission of craftwork

fostered an approach to God; and, finally, an aesthetic value, as it highlighted the beauty of craftwork pieces as opposed to the ugliness of the industrial production.<sup>25</sup> Moreover, as the press at the time showed, this craftwork revival aimed to 'embrace the Spanish style in our homes again'<sup>26</sup> by searching for national values in craftwork pieces and going back to traditional models. This desire to go back to craftwork showed some similarities with the beginning of Nazism, since Hitler's Regime presented women as 'the guardians of the German culture' and as the ones responsible for keeping the traditional songs, dances, dresses and craftwork typical of the country.<sup>27</sup> The interaction between the fascist ideology and the desire to go back to craftwork traditions would also be a permanent feature of the Italian fascism and until 1944 different trilateral events between Spain, Germany and Italy were common on Spanish soil.

The starting point of this reevaluation of craftwork was the creation of the *Obra Sindical de Artesanía* ('Crafts Syndicate') in 1940, conceived as a local organization, aimed at providing assistance, and included in the corresponding 'vertical union'. Its activities went from the elaboration of a census containing occupations (385 occupations) and a local census of handicraft artisans, to some specific activities like craft markets, organization of exhibitions and contests, artisans' cooperatives or the awarding of loans. As most part of the artisanal activities was performed by women, the Women's Section got involved in their vitalization. In the same way that there had been a process to rescue Spanish popular music and dances through the *Coros y Danzas* ('Choirs and Dance') groups, presenting them as a combination of physical exercise and promotion of the national roots,<sup>28</sup> the training on craftsmanship monopolized the education of the young Spanish women.

It seems that the willingness of the Women's Section to promote craftwork started out in the last months of the civil war, as an activity that could provide additional resources to peasant families of the national faction. In May, 1939 there was a craft fair in Santander with Spanish products, which later on travelled to San Sebastián and Valencia in 1940. In the VI National Conference of the Women's Section held in Granada on January 2, 1942, it was agreed to collaborate with the *Obra Sindical de Artesanía*, in order to disseminate the craftwork production throughout the country and provide assistance in the organization of its activities. In October of the same year the first national craft fair was organized out of the country, with an itinerant exhibition that travelled to Lisbon, Berlin, Frankfurt-am Maine and Vienna. Moreover, a singular body of craftswomen was created and entrusted with the elaboration of a 'Census of Handicraft Artisans'.<sup>29</sup>

25 Ángel Llorente, *Arte e ideología en el franquismo (1936–1951)* (Madrid: Visor, 1995), 56.

26 *ABC*, July 21, 1942, 16.

27 Jill Stephenson, *The Nazi Organización of Women* (New York: Routledge, 2013), 12.

28 The great success of *Coros y Danzas* was due to their international tours and the success of the film *Ronda Española*, released in 1957 and directed by Ladislao Vajda.

29 Luis Suárez Fernández, *Crónica de la Sección Femenina y su tiempo* (Madrid: Asociación Nueva Andadura, 1993), 148.

23 *Medina*, December 5, 1943.

24 Juan (Brian) Basilio Gómez, *La decoración de la casa modesta* (Barcelona: Leda, ca.1950), 10.



Figs. 7 and 8. Inauguration of the craftwork courses organized by the Women's Section with a delegate of the Nazi delegation in Madrid, 1942. Courtesy of Fondo Santos Yubero, ARCM.

The so called 'apprenticeship training' delivered in the *Talleres-Escuela* ('Workshop-School') of the Women's Section, and whose objective was to provide training to ensure a better economic stability in a future life, included theoretical and practical training on art, Spanish craftwork and geographical situation of the Spanish craftwork, emphasising the details 'typical of a specific region'.<sup>30</sup> That is, the objective was not to achieve a deep knowledge about the Spanish craftwork tradition, but to get a general idea on a theoretical basis and to achieve a practical performance according to the characteristics of each region (Fig. 7). They organised workshops to learn how to make dolls, toys, carpets, laces, weaving, knitting, and how to work with straw, wicker and hemp. It is worth mentioning that in this same training program for woman under eighteen years of age, ten out of the twenty topics covered in their History of Art subject were the so called 'minor arts', maybe because these skills were considered better suited for their future life rather than, for example, painting skills. It must be taken into account that the range of techniques and models was huge because of the country's rich craft tradition and every territorial organisation identified the potential of each region in different crafts (Fig. 8).

The basic reason for this promotion of the craftwork performed by women was to alleviate the terrible economic situation of many families in the post war period, but there was also a deep underlying nationalistic feeling, with a strong wish to keep local tradition and national products. This shows

one of the contradictions of the Women's Section: in spite of the strong defense of the national catholic role of women, who were restrictively limited to the household, it favored self-employment and promoted entrepreneurship culture on a small-scale, in which even the husbands and children in the family collaborated.<sup>31</sup>

### Conclusion

The Women's Section, as an organisation for women in the Francoist era, developed intense training activities aimed at a model of catholic bourgeois woman as the perfect housewife, who met the needs of her husband and of a traditional fascist society. From its creation in 1934, the Women's Section promoted the idea of the woman as mother and wife, keeping the house clean and neat, with no ambitions, always recycling and a on a constant state of self-production. That way, women of the first period of Franco's Regime were decorators and producers at the same time, designers and decorators of their homes in the post-war period, which had no national industry or distribution channels, in a country devastated by the Civil War. In the same vein, the Women's Section promoted the recovery of craftwork in a national ideology that praised the popular values of the State. Women took part in this craft renovation as manufacturers and even entrepreneurs in charge of modest small companies.

<sup>30</sup> Falange Española Tradicionalista y de las JONS. Delegación Nacional de la Sección Femenina: *Plan de formación de las juventudes* (Madrid: Afrodísio Aguado S.A., 1946), 214.

<sup>31</sup> Alison Lever, "Capital, Gender and Skill: Women Homeworkers in Rural Spain," *Feminist Review* 30 (1988), 6.

**Ana María Fernández García**

Department of Art History, University of Oviedo, Spain



Ana María Fernández García holds a PhD in Art History (with honors). She specialised in artistic relations between Spain and America as regards contemporary art and she is currently working on decorative arts in Spain. She has been a visiting researcher at the Universities of Buenos Aires, Santiago de Chile, UNAM Mexico, Cambridge and Kingston. She has published several books and articles on Spanish art in Argentina, Chile, Cuba, Ecuador and United Kingdom. She has also been president of the Danae Foundation, curator of the Selgas Fagalde Foundation and coordinator of the European Master in Conservation, Preservation and Heritage Management. She works at the University of Oviedo in Spain.

E-mail: [afgarcia@uniovi.es](mailto:afgarcia@uniovi.es)



Marjan Groot

## Visual Sources and Women's History: a Documentary about the Life and Work of Dutch Graphic Designer and Teacher Tine Baanders (1890–1971)



Play video

Around the millennium, I was tracing and researching the work of women designers and architects in the Netherlands who were active between 1880 and 1940. The idea of presenting a documentary with visual historical material at the first MoMoWo conference workshop at the University of Leiden, the Netherlands, about women designers, architects, and engineers between 1918 and 1940, comes from my experience then. Wanting to learn more about the practices of individual women as designers, architects, or engineers, I encountered difficulties in finding archival sources and written documents in public archives. The reasons for the lack of documents are sometimes that women had not been active in the field for a long time or had not achieved much because they stopped working when they got married. Sometimes they did not retain their work and documentation for later preservation in public archives because they did not believe it to be of any future importance – they were designing for the moment, not thinking about possible historical interest later. Confronting the gaps in public archives, I could only attempt to trace family connections and private archives that might hold documentation relating to the women whose names I came across and could help in (re)constructing their histories. Perhaps relatives could remember something of the lives of their grandmothers, mothers, or great-aunts, or of people whom the designers met.

A case study of the graphic designer Tine Baanders (1890–1971) was a good opportunity to address the importance of private archives for historical research on women architects and designers in the context of the first MoMoWo conference workshop for the period 1918 to 1940. Tine Baanders lived in Amsterdam and was active between 1910 and 1960. She did not have any children and after her death her papers and letters were kept by other members of her family. Today they hold a large number of negatives, photographs, and letters documenting not only her own life and work, but also that of her many Dutch and foreign friends who were part of the network of artists and designers in Amsterdam. Mr. Broos Baanders, a great-nephew of the designer, is actively involved in ordering and analysing the archive, having used it for a small exhibition and lectured about it himself. Working together, he, his daughter Sanderijn Baanders, Thomas Vorisek (technical assistant at the University of Leiden), and I produced a documentary about 30 minutes long with a focus on visual source material. It was first presented at the MoMoWo conference at the University of Leiden on Friday 25 September 2015. To watch this documentary please click the: [link](#).

Maria Helena Souto

## Representation Introduction

The four articles highlight the numerous ways women have been left out of modern architecture and design history publications, and analyses the different paths of the women 'left in the shade.' In the article by Florencia F. Cardoso we can observe how women architects and designers are still unequally portrayed by historians. We submerge into pioneer cases in the articles by Lucia Krasovec, Laura Martinez, and Maria Perers, all of which focus on women who have contributed to the image of their countries through their work and participation in international exhibitions.

Cardoso develops 'a quantitative and qualitative content analysis of the documentation of women's achievements in modern architecture history publications'. She focuses on ten books published in a ten-year period (2004–14) and observes that inequality of recognition between men and women's achievements still remains and that there is 'a lack of acknowledgement of women's contributions to modern architecture,' especially when compared to the pioneering book and exhibition by Susana Torre, *Women in American Architecture* (1977).

Krasovec's article provides paradigmatic examples of pioneering cases, focusing on how the Women's Building in the Chicago International Exhibition of 1893 designed 'a strategy to gender subsequent pavilions, [and that] female architects were encouraged to design them'. She presents similar cases in Germany, and also focuses on the Italian architect Maria Teresa Parpagliolo Shepard and her 'approaches in an innovative way to architecture, gardening and landscape issues.'

The interesting study by Laura Martinez analyses the impact of Anni Albers's visit to Barcelona International Exhibition in 1929 when she was still a Bauhaus student, on her later work. Martinez highlights the impact of the many interiors Lilly Reich and Mies van der Rohe designed for the German sections in eight separate Beaux-Art palaces 'on architectural culture from then on', particularly the use of woven textiles as architectural elements.

Maria Perers begins her article by examining the impact of the Swedish Pavilion at the 1925 Paris Exposition Internationale des Arts Décoratifs et Industriels Modernes and how this success was transferred to the United States in 1928 via the luxury passenger liner M/S Kungsholm. She analyses how this success is largely related to the work by Swedish designer Anna Petrus whose works are studied by the author.

## Modern Women in (Modern) Architecture: Some Cases (Genesis of a Modern Lifestyle)

The presence and influence of women as architects and designers, has not yet been sufficiently explored in terms of social change. From the end of the 19th century we find very strong and innovative female influence in architecture, design and urban planning projects. The origins of the modern women's approach to architecture emerges mostly from the world fairs in America during that period, when the social influence of women determined occasions for a specific professional role in architecture. At the beginning of the 20th century, American experiences were exported to Europe through fairs and exhibitions, generating a model for the new generation. What did actually drive these women to choose this profession and what did they have in common? What were their aims and what concepts did they have of the new era? In a nutshell the Italian scenario of that historical era reveals how women –who had a profound impact on Modernist history even while working at the periphery of the profession– have changed the idea of living, working, learning, having fun, even if their works sometimes remains under the 'tradition of misattribution'. The case of Maria Teresa Pargagliolo Shepard is significant both as an instance of Italian pioneering innovative landscape architect and as a promoter of a new lifestyle.

Keywords: design, architecture, women pioneer, landscape, exposition

Women became architects and engineers especially in the second part of the nineteenth century, after the industrial revolution and important changes in life and cultural aspect of the society.

At the beginning, most of them chose this profession because of their particularly high social status, even working in the shadow of established architects.

However, earlier we can find some rare cases of the architectural profession practiced by women that constitute cases of great excellence. Women involved in architecture belonged to noble or important families that allowed them to do architecture although generally, at the same time, they avoided publicize their works.

For example, Katherine Briçonnet (1494–1526) had great influence in designing her husband's property, Château de Chenonceau,<sup>1</sup> managing the construction work and taking important architectural decisions while her husband was away fighting in Italian wars. Named 'Château des Dames', the castle was successively embellished by Diane de Poitiers and Caterina de Medici.

One century later, Plautilla Bricci (1616–1690) was the first woman to practice architecture and her reputation has clearly survived to the present day, although the full extent of her activities remains to be explored. In 1663 Bricci designed the Villa Benedetti (destroyed in 1849), near the Porta S. Pancrazio on the Janiculum Hill, for Elpidio Benedetti, agent to Cardinal Jules Mazarin in Rome. Benedetti was so pleased with the result that in 1677 he published a guidebook to the villa giving detailed descriptions and views of the building along with an account of the roles played by Plautilla and her brother, with whom it is said she collaborated. However, the building contracts and several preparatory drawings make it clear that it was, in fact, Plautilla who designed the building with little,

<sup>1</sup> Eugène Aubry-Vitet, "Chenonceau," *Revue des deux mondes* no. 2 (1867), 851–881, <https://rddm.revuedesdeuxmondes.fr/archive/article.php?code=64538> (accessed June 12, 2017). First published by M. Abbé Chevalier, *Pièces historiques relatives à la Chastellanie de Chenonceau publiées pour la première fois d'après les originaux* (Paris: Techner, 1864–1866), in 5 vol.

if any, creative input from Basilio. Benedetti was probably embarrassed to admit that his villa had been entirely designed by a woman.<sup>2</sup>

Yet Lady Elisabeth Mytton Wilbraham (1632–1705) set up an architectural office near Birmingham and eventually designed 400 buildings. As the historian John Fitzhugh Millar wrote, she might also have taught her most famous colleague, Christopher Wren, who rather abruptly took up architecture in the XVII century after a decade as an Oxford scientist.<sup>3</sup> Even if she did not sign her drawings because her aristocratic milieu would have disapproved of a working woman, the library at Weston Park, in the village of Weston-under-Lizard, owns some tangible evidence of her interests - copious notes about building techniques and raw materials she signed in her 1663 volume of Palladio's writings. Given the situation of a woman acting as an architect during a period in history when that was socially unacceptable, it is still not clear the documentation of Wilbraham's authorship of any building, other than for her family.

The first women architects worked from about the second part of 1800 in America, either independently or as the wife of male architects. What drove these women to choose this profession and what aims and ideas of the new era did have had in common? To answer this question, it is necessary to investigate the events that led to the occasions in which women were able to express their creativity and skills in the field of architecture. At the time, it was mostly based on the intersection of the new bourgeois femininity coupled with the political and economic power relevant to the growth of the nation states.

In the mid-nineteenth century, the Woman's Building made its appearance at the world exhibitions, and up until the First World War it remained a significant component of these events. The world exhibitions provided a showplace to present and to celebrate the industrial production of the emerging nation states - the locus of every kind of human activity,<sup>4</sup> where any number of contemporary social or cultural concerns also found expression. The Women's Building represented gender difference -as did the emerging women's movements- at venues which championed display of industrial production. It represented clearly bourgeois femininity in a didactic form, even if it would repeatedly

reinforce traditional female roles. Anyway, the Women's movements demanded that women occupy a more active role in the public sphere. Women's Buildings rendered this demand more visible and, step by step, the architecture of those pavilions also contributed to change the concept of what a woman should be, and to promote women's active participation in design and realisation of such.<sup>5</sup>

The first realisation for the *Chicago Columbian Exposition* in 1893, is significant. Because the managing board of the fair agreed to allow women to participate, a separate Board of Lady Managers that had authority over all the decisions regarding the Women's Pavilion was created. The competition was opened to trained architects, women only, and this pavilion was a promising first step that would set a precedent for women's involvement in later years.<sup>6</sup> The winner, Sophia Hayden (1868–1953), was young and had just graduated. She submitted a design based on her thesis project for a fine arts museum in an Italian Renaissance style. Her design for the fair building included balconies and loggias and was perceived as 'light and gay,' in the words of one of the judges, qualities deemed appropriate for a festive event. Paid the small sum of \$ 1000 plus expenses, and compelled to reduce the scale of her details, Hayden was forced to make changes on short notice and with little time. Hayden spent two years completing working drawings, designing a building that was both positively and negatively reviewed by architectural journals for the same reason: it was made by a woman!<sup>7</sup>

In 1891 the architect, Jennie Louise Blanchard Bethune (1856–1913), wrote the article 'Women and Architecture' for the *Inland Architect and News Record*, in which she voiced her disgust at the competition and the pathetic remuneration offered, while male colleagues received up to ten times that amount for their expo buildings. In her words, it was an 'unfortunate precedent to establish just now, and it may take years to live down its effects'.<sup>8</sup> Whatever problems there may have been, this was a far more substantial commitment to women than any fair had previously made and the building represented the display of women's achievements. The design process of Hayden's debut work was often interfered with by the supervision of Bertha Palmer, a powerful Chicago businesswoman, socialist and president of the Board of Lady Managers. During the initial planning phase, the Board, aligned with the organisers of the Exposition, developed the dimensions of the

2 Yuri Primarosa, "Nuova luce su Plautilla Bricci pittrice e architettrice," *Studi di Storia dell'Arte* no. 25 (2014), 145–161, [https://www.academia.edu/12116062/Nuova\\_luce\\_su\\_Plautilla\\_Bricci\\_pittrice\\_e\\_architettrice\\_](https://www.academia.edu/12116062/Nuova_luce_su_Plautilla_Bricci_pittrice_e_architettrice_) (accessed June 12, 2017).

3 John Fitzhugh Millar, "The First Woman Architect," *Architects Journal*, November 11, 2010, <https://www.architectsjournal.co.uk/the-first-woman-architect/8608009.article> (accessed June 12, 2017); Eve M. Kahn, "Maybe a Lady Taught Christopher Wren," *The New York Times*, March 8, 2012, <http://www.nytimes.com/2012/03/09/arts/design/the-case-for-a-17th-century-female-british-architect.html> (accessed June 12, 2017); Jay Merrick, "Elisabeth Wilbraham, the first lady of architecture," *Independent*, February 16, 2011, <http://www.independent.co.uk/arts-entertainment/architecture/elizabeth-wilbraham-the-first-lady-of-architecture-2215936.html> (accessed June 12, 2017).

4 Sigfried Giedion, *Space, Time and Architecture: The Growth of a New Tradition*, 5<sup>th</sup> edition (Cambridge Mass.: Harvard University Press, 1967), first edition 1941.

5 Mary Pepchinski, "The Woman's Building at the World Exhibitions: Exhibition Architecture and Conflicting Feminine Ideals at European and American World Exhibitions, 1873–1915," *Wolkenkuckucksheim: Internationale Zeitschrift zur Theorie der Architektur* 5, no. 1 (2000), <http://www.cloud-cuckoo.net/openarchive/wolke/eng/Subjects/001/Pepchinski/pepchinski.htm> (accessed June 12, 2017).

6 The Board of Lady Managers was a governing body, and the first of its kind, see: Maud Howe Elliott (ed.), *Woman's Building of The World's Columbian Exposition: Chicago, 1893* (Chicago, New York: Rand, McNally & Company, 1894), <http://digital.library.upenn.edu/women/elliott/art/art.html> (accessed June 12, 2017); Sarah Allaback, *The First American Women Architects* (Urbana-Champaign: University of Illinois Press, 2008).

7 Allaback, *The First American Women Architects*.

8 Margaret Moore Booker, "Hayden (Bennett), Sophia (Gregoria)," in Joan Marter (ed.), *The Grove Encyclopedia of American Art* (Oxford: Oxford University Press, 2011).

plan and the idea of the structure with the Fair's supervising architect, Daniel Burnham. For the first time women architects were discussed in a lively public forum and the two most accomplished colleagues, Louise Blanchard and Minerva Parker Nichols (1863–1949), contributed their views to major periodicals.<sup>9</sup> In the summer of 1882 Hayden suffered a nervous breakdown, likely the result of the intense pressure she was under. Some used her illness as proof that women did not belong in architecture, while others, such as fellow architect Minerva Parker Nichols who also participated at the competition, came to her defence. For her design, Hayden was given a gold medal and an award for 'delicacy of style, artistic taste, and geniality and elegance of the interior hall'. At the ceremony held in her honour in June 1893, Hayden was praised for creating 'a lasting monument to her genius and a source of pride to women for all ages to come'. The following year she designed a building for the Women's Club of America, but it was never completed. Burnham suggested she open an architectural firm in Chicago, instead she chose to retire from the field.<sup>10</sup>

The Woman's Building reflected the growing association of American bourgeois femininity with the patronage of the fine arts. As the American painter Anna Lea Merritt (1844–1930) observed,

recent attempts to make separate exhibitions of women's work were in opposition with the views of the artists concerned, who knew that it would lower their standard and risk the place they already occupied. What we so strongly desire is a place in the large field (...). The kind ladies who wish to distinguish us as women would unthinkingly work us harm.<sup>11</sup>

In any case, the Columbian Exposition set the precedent for a Women's Building at the Cotton States and International Exposition held in Atlanta two years later, when the Women's Department sponsored a national competition in search of a talented female designer. The request was for a building in the colonial design, 'to harmonize and at the same time to be able to hold its own among the much larger buildings in its immediate vicinity'.<sup>12</sup> In 1895, when she worked in the Pittsburgh architectural office of Thomas Boyd, Elise Mercur (1864–1947), a Pittsburgh architect, won the competition and a prize of \$100. The building was the most expensive for its size at the fair and the only building to have a

cornerstone laid.<sup>13</sup> At time, it was noted that 'she goes out herself to oversee the construction of the buildings she designs, inspecting the laying of foundations and personally directing the different workmen from the first stone laid to the last nail driven, thereby acquiring a practical knowledge not possessed by every male architect'.<sup>14</sup> While Sarah Ward Conley (1859–1944) authored the one at the 1897 Tennessee Centennial in Nashville, Elise Mercur developed a two-story, multifunctional building modelled on a regional paradigm, the Southern antebellum plantation house.

Following the Chicago example, as a strategy to gender subsequent pavilions, female architects were encouraged to design them, and encountered all the difficulties related to the practice of this profession, and especially the recognition of women's capacity to manage a project and the execution of a construction.

The Columbian Exposition also paved the way for women to begin designing structures of all types, such as Josephine Wright Chapman's (1867–1943) design for the New England States Building which won the competition for the upcoming Pan-American Exposition in Buffalo in 1901.

Later, inside the Panama-Pacific International Exposition held in San Francisco in 1915, the YWCA Building, sponsored by the Young Women's Christian Association at the insistence of local heiress Phoebe Hearst, was erected. The building's exterior is designed by the architect Edward C. Champney of San Francisco (1874–1929), and the architect Julia Morgan (1872–1957) was asked to design the pavilion's interior. It's interesting that, in this case, function had overtaken meaning, as the building was created to serve women working and participating in the public sphere. Julia Morgan was the first woman to graduate from the Beaux-Arts in Paris and in 1904 had established a successful practice in San Francisco Bay Area. It must also be said that, at time, she was a seasoned professional having built extensively for both the Hearst family as well as for the YWCA.<sup>15</sup>

In Europe, the process of the emancipation of women professional architects has had a longer incubation. Professional practice was still outside the norm for women in the nineteenth century.

Around 1900, representative Women's Buildings also appeared at European fairs. There were many occasions to talk about women at the Expositions, but there isn't evidence of the involvement of women architects designers. For example, the Palais de la Femme, at the *Exposition Universelle et Internationale de Paris* in 1900, was a small pavillion praised for conveying a sense of the *Parisienne*. Under the supervision of Madame M. Pégard, it was executed in a charming Baroque style, a small

9 Kathleen D. McCarthy, *Women's Culture: American Philanthropy and Art, 1830–1930* (Chicago: University of Chicago Press, 1991); see also Anna Burrows, "The Women's Pavilion," in Patricia Kosco Cossard and Isabelle Gournay (eds.), *Essays on the Material Culture of the World's Fairs*, University of Maryland Libraries, University of Maryland, 2005, <http://digital.lib.umd.edu/worldsfairs/record?pid=umd:997> (accessed June 12, 2017).

10 Bruce G. Harvey, *World's Fair in a Southern Accent: Atlanta, Nashville and Charlestone, 1895–1902* (Knoxville: University of Tennessee Press, 2014).

11 Sharon Foster Jones, *The Atlanta Exposition* (Mount Pleasant (S. Carol.), Arcadia Publishing, 2010); Coons F. H. Boyd, "The Cotton States and International Exposition in the New South, Architecture and Implications" (Master's thesis, University of Virginia, 1988).

12 Allaback, *The First American Women Architects*; Mary Temple Jamison, "Pittsburgh's Woman Architect," *Home Monthly*, April 1898.

13 Mary Pepchinski, "Woman's Buildings at European and American World's Fairs, 1893–1939," in Tracy Jean Boisseau and Abigail M. Markwyn (eds.), *Gendering the Fair. Histories of Women and Gender at World's Fairs* (Urbana, Chicago and Springfield: University of Illinois Press, 2010).

14 Foster Jones, *The Atlanta Exposition*; Boyd, *The Cotton States*; Allaback, *The First American Women Architects*; Temple Jamison, "Pittsburgh's Woman Architect."

15 Sara Holmes Boutelle, *Julia Morgan: Architect* (New York: Abbeville Press, 1988).

masterwork of modern French architecture, decorated with tasteful latticework, flowers, artful stone basins and fountains, where the architect Emmanuel Pontremoli (1865–1956) understood how to embody the grace and the attraction of appealing femininity in stucco and stone.<sup>16</sup>

In Britain, there were barriers to the presence of women in the professional field of architecture. The Institute of Architects, founded in 1834, was 'undeniably, a male preserve (...) For the emerging architectural profession, women in their ranks were quite simply unthinkable', as the architects-members were to be 'men of taste, men of science, men of honour'.<sup>17</sup> The RIBA –Royal Institute of British Architects– did not admit women until 1898 although during the 19th and 20th century some women –mostly from a family architects– did practice as professionals outside the auspices of the RIBA. Women's place in the profession was envisaged and inscribed by Robert Atkinson (1883–1952), head of the AA School in London in 1917: '(...) women would find a field for their abilities more particularly in decorative and domestic architecture rather than the planning of buildings 10 to 12 stories high'.<sup>18</sup>

The first female-designed pavilions were constructed in 1914, at competing fairs in Germany. Margarethe Knüppelholz-Roeser (1886–1949) created a one-story building with stark unornamented facades, coloured in deep ochre tones for the Werkbund Exhibition in Cologne. Emilie Winkelmann (1875–1951) designed the Haus der Frau for the 1914 *Internationale Ausstellung für Buchgewerbe und Graphik* – Bugra (International Exhibition for the Book Industry and Graphic Design) in Leipzig. She also arranged the twenty-five finely furnished exhibition rooms, each differing in size and decoration, into a long building clad in light grey with neo-baroque facades.<sup>19</sup>

By the turn of the century, more and more women who were joining the pioneer generation of architects were finding that higher education gave them access to new opportunities. Now women without male relatives or friends in the profession could decide to become architects, even assuming they could pay for their education. There is evidence that more women architects were beginning to join others by the early twentieth century.<sup>20</sup>

16 The building was located close to the Eiffel Tower. It housed an exhibition on women artists that had received prizes during the Fair. It also had a few theatres, a large entrance hall where visitors could come and rest, and a reading room; there was also a section dedicated to beauty products. See Paul Lindenburg, *Paris un die Weltausstellung* (Minden i. Westfalen: J. C. C. Bruns' Verlag, 1900); Anne St. Cere, "Der Frauenpalast auf der Pariser Ausstellung," in Georg Malkowsky (ed.) *Die Pariser Weltausstellung in Wort und Bild* (Berlin: Kirchhoff & C.o Verlag, 1900), 15–16, <http://digi.ub.uni-heidelberg.de/diglit/malkowsky1900/0003?sid=6e96e774c9bc3e0d0276a25ed9832fc6> (accessed June 12, 2017).

17 The first woman member was Ethel Mary Charles (1871–1962) and she was also the first woman to address an architectural society in Great Britain, see Lynne Walker, "Golden Age or False Dawn? Women Architects in the Early 20th Century," <https://content.historicengland.org.uk/content/docs/research/women-architects-early-20th-century.pdf> (accessed June 12, 2017).

18 Walker, "Golden Age."

19 Jeremy Aynsley, *Graphic Design in Germany: 1890–1945* (Berkeley, Los Angeles: University of California Press; London: Thames & Hudson Ltd., 2000), vol. of series Weimar and Now: German Cultural Criticism.

20 Walker, "Golden Age."

The Italian scenario of that historical period may reveal, in short, how women, who have had a profound impact on Modernist history, even while working on the periphery of the profession, changed the idea of living, working, learning, having fun.

In 1927 Mussolini uttered the sentence 'Women should be passive. The woman must obey. She is analytic and not synthetic (...) my view of the role of women in the state is opposed to feminism. Naturally she does not have to be a slave; but if I gave her the right to vote, she would deride me. In our state she simply does not count'.<sup>21</sup> In this political and social climate in which it was difficult to emerge in this profession, there are multitalented women who left a distinct impression on the Italian architectural scene with their own firm, involved in important fairs and other important works.

From 1920 to 1940, the exhibitions realised in Italy were an integral element of the processes and techniques of building consent, with a range of different themes, staged with the indispensable contribution of the artistic and architectural professions. The didactic function of these exhibitions and pavilions constituted a kind of campaign to promote a national lifestyle.

The *IV Triennale* of Monza in 1930 was an important occasion for the comparison of academic and rationalist architecture. Some enterprises, such as Edison and Rinascente, promoted the research of innovative housing solutions giving the opportunity for young Italian architects such as Emilio Lancia, Gio Ponti, and Gruppo 7, to build housing prototypes in the Villa Reale Park. The exposition of these prototypes was replicated in the *V Triennale* in Milan in 1933, and provided significant input to the Modern House Show with more than 30 buildings, for social or private destination, and with different economic ranges.<sup>22</sup> Among the participants, Luisa Lovarini (1895–1980), graduated from the Academy of Fine Arts in Bologna and employed by the Opera Nazionale Dopolavoro, the national institute providing assistance to workers, designed the Casa del Dopolavorista (After-Work House), a one-story house fully furnished.<sup>23</sup> In Italy, it was the first important architectural contribution from a woman architect.

21 Tracy H. Koon, *Believe, Obey, Fight: Political Socialization of Youth in Fascist Italy, 1922–1943* (Chapel Hill and London: University of North Carolina Press, 1985); Emil Ludwig, *Colloqui con Mussolini* (Milano: Mondadori, 1932).

22 Flavia Marcello, "Fascism, Middle-Class Ideals, and Holiday Villas at the 5th Milan Triennale," *Open Arts Journal* 2, (Winter 2013–14), DOI <http://dx.doi.org/10.5456/issn.2050-3679/2013w08fm> (accessed January 10, 2016).

23 Gio Ponti, [editorial on architecture at V Triennale di Milano], *Domus* 11, no. 61 (January 1933), 1, [http://www.casadellarchitettura.eu/fascicolo/data/2010-12-18\\_434\\_598.pdf](http://www.casadellarchitettura.eu/fascicolo/data/2010-12-18_434_598.pdf) (accessed June 13, 2017); Mattia G. Granata, *Smart Milan: Innovation from Expo to Expo (1906–2015)* (Cham, Heidelberg, New York, Dordrecht, London: Springer, 2015); Grace Lees-Maffei and Kjetil Fallan (eds.), *Made in Italy: Rethinking a Century of Italian Design* (London: Bloomsbury Academic, 2014); Ferdinando Reggiori, "La triennale di Monza: IV Mostra Internazionale delle Arti Decorative," *Architettura e Arti Decorative: Organo del Sindacato Nazionale Architetti* 9, no. 11 (July 1930), 481–526, [http://www.casadellarchitettura.eu/fascicolo/data/2013-10-30\\_581\\_2554.pdf](http://www.casadellarchitettura.eu/fascicolo/data/2013-10-30_581_2554.pdf) (accessed June 13, 2017). The Milan Triennale Exhibition of Modern Industrial and Decorative Arts and Modern Architecture developed out of the biennale International Exhibition of Decorative Arts which it took place in Monza in 1923. After three exhibitions, in 1930 it was renamed the International Triennial Exhibition of Modern and Industrial and Decorative Arts, and it began to be organised according to techniques.

The house was published in *Edilizia Moderna*,<sup>24</sup> with two illustrations: the building from the garden and the living room, showing the non-luxury house for the new middle-class, and the application of innovative materials, as linoleum, and a more appropriate organisation of the living space and modern facilities. The design of the house was extended to the outdoors as the garden was considered an important part of the house where 'everyday life pulses and collaborates for the happiness of the family', and its design was fundamental for the success of the whole project. The project was successful and it was described by Lidia Morelli as a little jewel of practicality, of good taste and low price.<sup>25</sup>

A few years later, Maria Teresa Parpagliolo Shepard, born in Rome (1903–1974), approached architecture, gardening and landscape issues in an innovative way to. She was the first Italian woman landscape architect. After she had started her university studies in archaeology, she developed interest in garden design and botany. She started to educate herself, studying all the available garden literature and taking several study trips. In 1931 she went to England where she trained in the office of Percy Stephen Cane (1881–1976). She participated in international conferences of European landscape architects (Paris 1937, Berlin 1938), and contributed regular articles for specialist magazines such as *Domus*, *Il giardino fiorito*, *Landscape and Garden*, *Journal of the Institute of Landscape Architects*. In 1938, she joined the planning team for the *Esposizione Universale* in Rome (E42), and in 1940 became head of the exhibition's *Ufficio Parchi e Giardini*. In 1946 Parpagliolo married Ronald Shephard, and moved to London starting to work on projects with Sylvia Crowe (1901–1997). From 1950, with Frank Clark (1902–1971) she designed for the Festival of Britain and the grounds of primary schools in the south of London. In 1954, the Società Generale Immobiliare commissioned her projects for private and public gardens, parks and open spaces.<sup>26</sup>

Parpagliolo was first involved in urban planning schemes with Raffaele De Vico (1906–1969) and Piero Porcinai (1910–1986), and she was soon appointed head of the Planning Department for Parks and Gardens of the World Exhibition, E 42, site in the south of the city and planned by Mussolini to open in 1942.<sup>27</sup>

When she started to have an interest in landscape architecture there were no specialised schools on the topic so she developed as a self-taught landscape designer travelling mostly in Italy, England, France and Germany, to make contact with garden designers and view their projects, and participating in thematic exhibitions and conferences.<sup>28</sup> Although she was hired for the job because of her excellent botanical knowledge and her ability to design planting plans and flower beds, Parpagliolo realised the new opportunities it offered for becoming involved in urban design and planning.

Serving the Fascist regime, she adhered to its political vision with her theoretical statements and design work for the exhibition E42. Yet she showed no regret and no lack of self-confidence when reflecting, in 1971, on her work within the male-dominated planning team: 'It was such an enormous job that I learned the profession doing one job and teaching all architects to see the site in a different way'.<sup>29</sup> In Parpagliolo's idealist vision, the healthy landscape consisted of functional natural systems and integrated social communities, and it provided the cultural meanings to support human life. Landscape architecture was a work of synthesis.

The innovative idea of domestic gardens and parks was that of a natural landscape, where a beautiful and functional landscape becomes an aesthetic expression of practical land-use, looking to an innovative spatial qualities of the city.<sup>30</sup>

Parpagliolo not only designed gardens and open spaces in Italy, she also wrote a lot of articles for specialist magazines on planting and garden design, urban design and broader environmental issues.

She explained her idea of garden architecture, influencing the readers and professionals on this issue then underdeveloped in Italy, by highlighting the fact that the garden and the landscape are part of the same picture. For Parpagliolo, this was a central point in the cultural debate of the twentieth century.

From soft suggestions for a pretty familiar open space to detailed technical instructions (Figs. 1 and 2), the theoretical principles of Parpagliolo were focused not only on geometrical or natural shapes,<sup>31</sup> but even on the issues of simplicity, balance and harmony between materials and plants. The practical examples of small gardens (Figs. 3 and 4), illustrate the close connection of the

24 Giuseppe Pensabene, "L'architettura alla Triennale," *Edilizia Moderna* 11–12, no. 10–11 (1933) 3–7, [http://www.casadellarchitettura.eu/fascicolo/data/2011-03-07\\_444\\_1769.pdf](http://www.casadellarchitettura.eu/fascicolo/data/2011-03-07_444_1769.pdf) (accessed June 13, 2017).

25 Katrin Cosseta, *Ragione e sentimento dell'abitare: La casa e l'architettura nel pensiero femminile tra le due guerre* (Milano: Franco - Angeli editore, 2000), vol. of series *Storia dell'architettura e della città*, [https://books.google.si/books?id=H0fmGJS1C8MC&printsec=frontcover&hl=sl&source=gbs\\_ge\\_summary\\_r&cad=0#v=onepage&q&f=false](https://books.google.si/books?id=H0fmGJS1C8MC&printsec=frontcover&hl=sl&source=gbs_ge_summary_r&cad=0#v=onepage&q&f=false) (accessed June 13, 2017); Victoria De Grazia, *How Fascism Ruled Women: Italy 1922–1945* (Oakland, Cal.: University of California Press, 1992).

26 Sonja Dümpelmann, "Maria Teresa Parpagliolo Shepard (1903–1974), Her Development as a Landscape Architect between tradition and Modernism," *Garden History* 30, no. 1 (Spring 2002), 49–73.

27 Massimo De Vico Fallani, *Parchi e giardini dell'EUR: Genesi e sviluppo delle aree verdi dell'E42* (Roma: Nuova Editrice Spada, 1988).

28 Dümpelmann, "Maria Teresa Parpagliolo."

29 Dümpelmann, "Maria Teresa Parpagliolo."

30 Sonja Dümpelmann, "Breaking Ground: Women Pioneers in Landscape Architecture: An International Perspective," in Patrick F. Mooney (ed.), *Shifting Ground, Landscape Architecture in the Age of the New Normal* (Vancouver: University of British Columbia, 2006), 45–50, Proceedings of CSLA/CELA Conference, 14–17 June 2006, Vancouver, British Columbia, Canada, <http://thecelaorg.ipage.com/wp-content/uploads/shifting-grounds-proceedings.pdf> (accessed June 13, 2017).

31 Maria Teresa Parpagliolo, "Giardino geometrico e giardino naturale," *Domus* 11, no. 61 (January 1933), 40–41, [http://www.casadellarchitettura.eu/fascicolo/data/2010-12-18\\_434\\_626.pdf](http://www.casadellarchitettura.eu/fascicolo/data/2010-12-18_434_626.pdf) (accessed June 13, 2017).

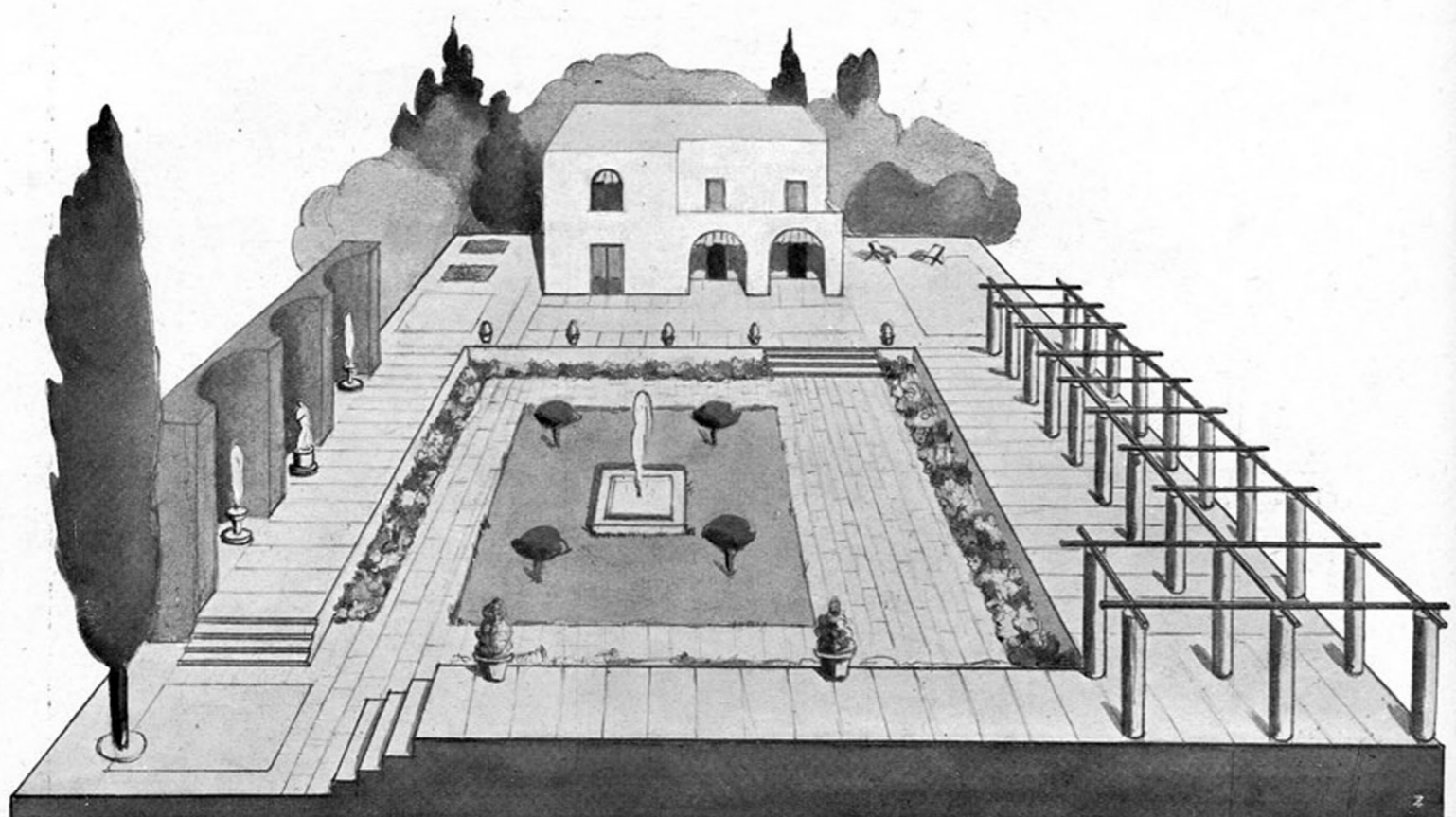

Fig. 1. Drawing of Geometrical garden by Maria Teresa Parpagliolo, in "Giardino geometrico e giardino naturale". Published in *Domus* 11, no. 61 (January 1933), 40.

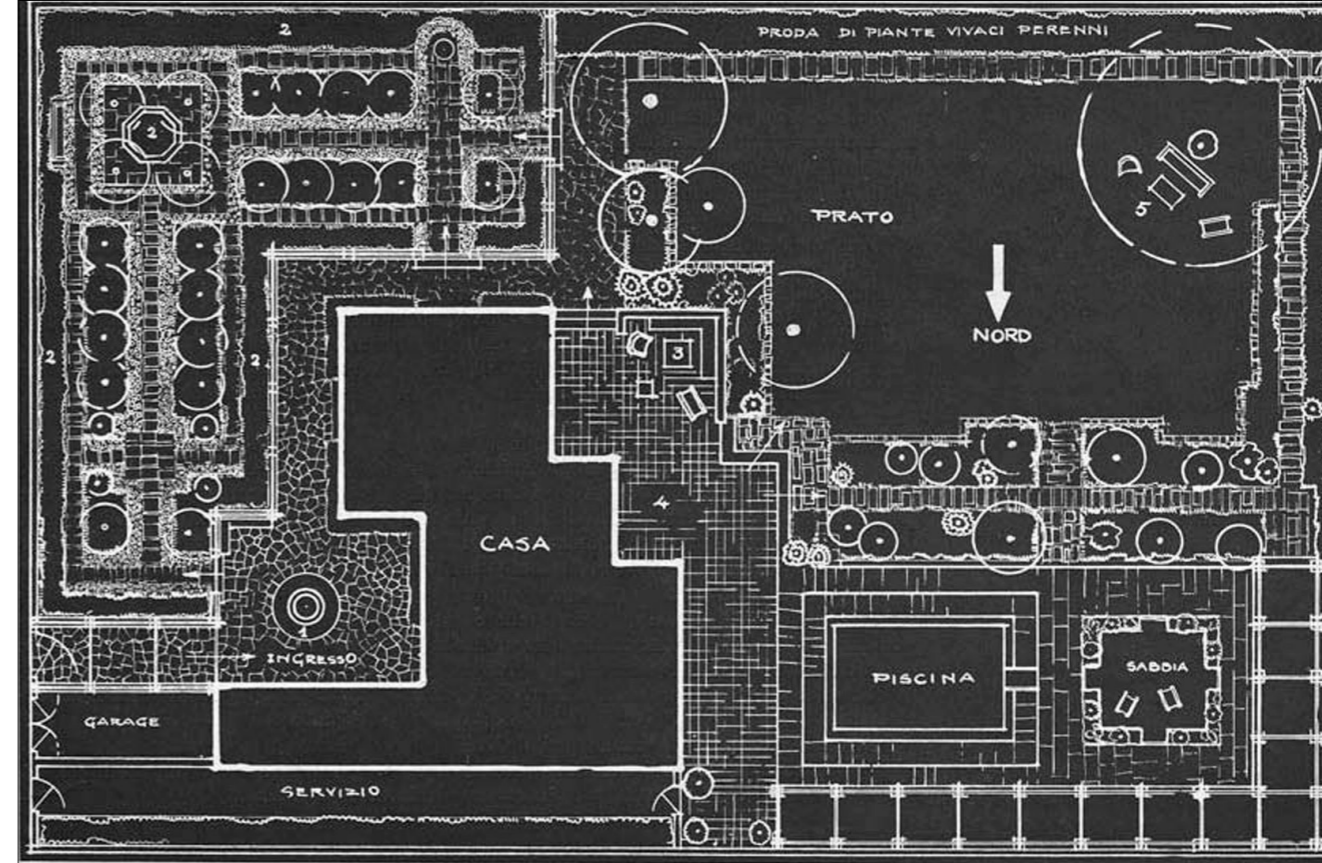

Fig. 3. Drawing of Small garden by Maria Teresa Parpagliolo, in "Delle parti di un giardino". Published in *Domus* 11, no. 62 (February 1933), 90.

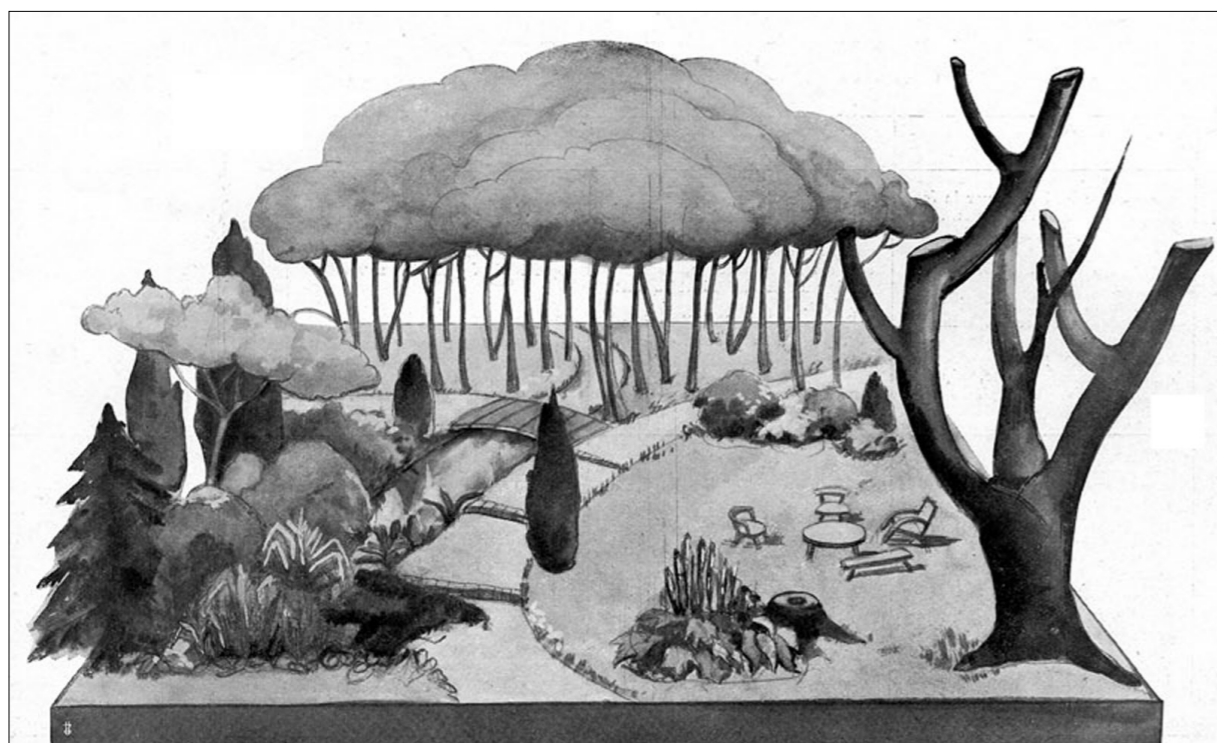
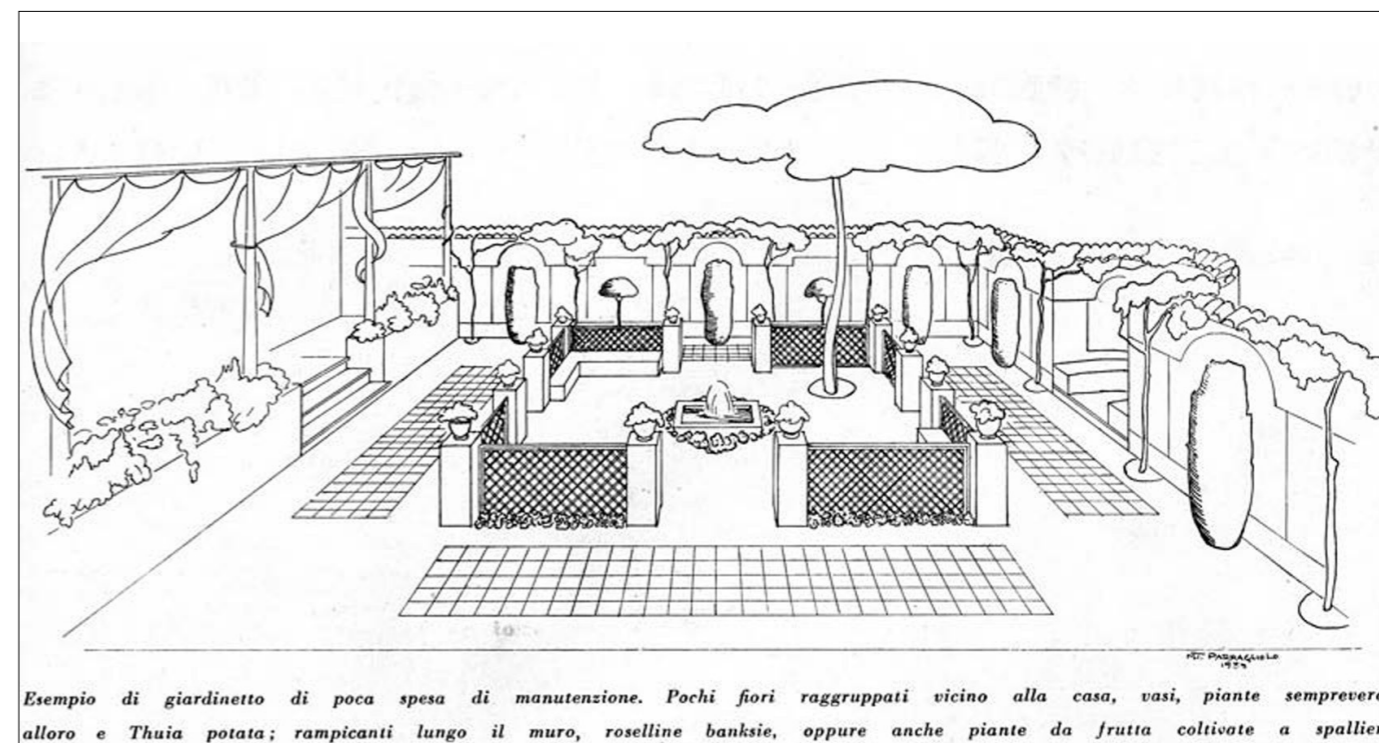

Fig. 2. Drawing of Natural garden by Maria Teresa Parpagliolo, in "Giardino geometrico e giardino naturale". Published in *Domus* 11, no. 61 (January 1933), 41.



Esempio di giardinetto di poca spesa di manutenzione. Pochi fiori raggruppati vicino alla casa, vasi, piante sempreverdi, alloro e Thuia potata; rampicanti lungo il muro, roselline banksie, oppure anche piante da frutta coltivate a spalliere.

Fig. 4. Drawing of Small garden by Maria Teresa Parpagliolo, in "Il piccolo giardino". Published in *Domus* 11, no. 64 (April 1933), 209.

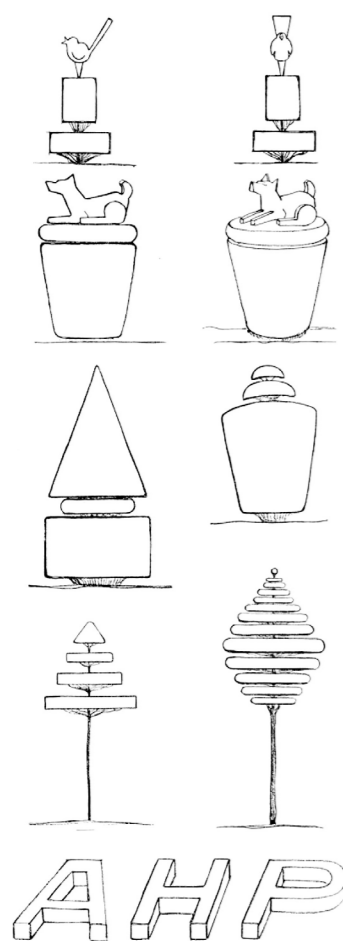

Fig. 5. Drawing by Maria Teresa Parpagliolo, in "Opus topiarium".  
Published in *Domus* 11, no. 65 (May 1933), 276.

building with its open space, for which the surroundings area became the extension of the house itself, like a room to fit, 'stanza da stare',<sup>32</sup> with green furniture and objects (Fig. 5).

Pietro Porcinai established, that her research is developed through the knowledge of the European experiences on landscape. In August 1938, before she started to work on E42, she took part in the Second International Conference of Landscape Architects in Berlin, from where she returned enthusiastic about the German approach to the landscape. In particular, she described the German highways whose shapes were studied in detail by expert professionals, and she began to promulgate the use of local plants in landscape design, the so called *fora classica*, in accordance with Fascist garden culture.<sup>33</sup>

In 1938, when she started project gardens and parks for the E42 with Porcinai and De Vico, she had already gained good international experience and she was able to draw an image of the modern Italian garden taking into account the political idealism of the Fascist period.

The town planning scheme of the world exhibition of 1938 paid great attention to the setting up of green areas, under the supervision of Marcello Piacentini (1881–1960), Superintendent of the Architecture, and Gaetano Minnucci (1896–1980), Director of Services relating to the Architecture, Parks and Gardens.<sup>34</sup> For this purpose, a special commission of architects and technical staff with a specific background in landscape architecture was established, and included Alfio Susini (1900–

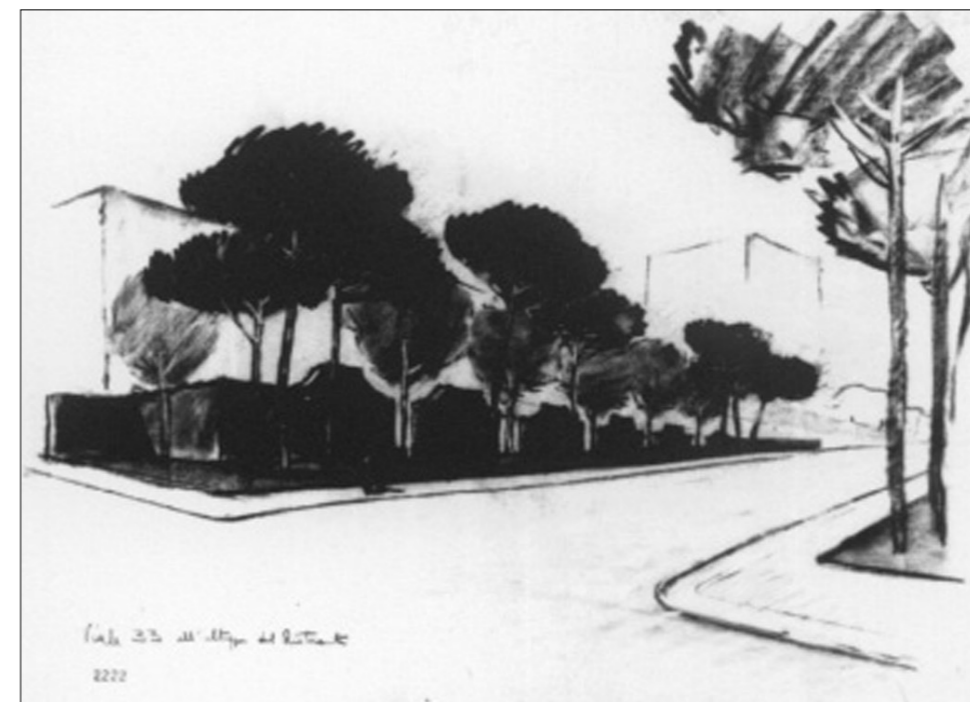

Fig. 6. Drawing attributed to Maria Teresa Parpagliolo, in Sonja Dümpelmann, "Maria Teresa Parpagliolo Shepard (1903–1974): Her Development as a Landscape Architect between tradition and Modernism". Published in *Garden History* 30, no. 1 (Spring 2002), 63.

1985), Guido Roda (1892–1971) and Maria Teresa Parpagliolo, who became head of exhibition's Planning Department for Parks and Gardens in 1940. During her work, Parpagliolo probably adjusted her ideas to the Fascist ideals of classical design, and this is clear in the project of a garden for the Exhibition of the Italian Garden. This turned out to be a collage of design elements found in different Italian renaissance and baroque garden resulting in unrelated garden rooms placed next to each other more or less at random.<sup>35</sup> Even if the aim of the exhibition was to define an innovative landscape character, at the end the design of gardens was subordinated to the Fascist classical ideal of *classicità*. Owing to increasing financial difficulties in late 1939, most of the projects were never realised. In projecting the green belt –as avenues, roads and squares– harmonisation of the panorama and the sky of Rome was planned with, based upon the choice of resinous trees, Italian pines, as the national symbol. Some sketches, showing a formal design with trimmed hedges along avenues and parks, show the image of the exhibition, as it should be. The drawings technique of a lot of perspective views for the E42 exhibition can be attributed to Parpagliolo: roads and avenues are attractive with shady trees, adorned with channels of water or a series of fountains (Figs. 6 and 7).<sup>36</sup>

<sup>35</sup> Dümpelmann, "Maria Teresa Parpagliolo."

<sup>36</sup> Dümpelmann, "Maria Teresa Parpagliolo."

<sup>32</sup> Maria Teresa Parpagliolo, "Delle parti di un giardino," *Domus* 11, no. 62 (February 1933), 90–91, [http://www.casadellarchitettura.eu/fascicolo/data/2010-12-18\\_433\\_655.pdf](http://www.casadellarchitettura.eu/fascicolo/data/2010-12-18_433_655.pdf) (accessed June 13, 2017); Maria Teresa Parpagliolo, "Il piccolo giardino," *Domus* 11, no. 64 (April 1933), 209, [http://www.casadellarchitettura.eu/fascicolo/data/2011-02-18\\_431\\_1593.pdf](http://www.casadellarchitettura.eu/fascicolo/data/2011-02-18_431_1593.pdf) (accessed June 13, 2017); Maria Teresa Parpagliolo, "Opus topiarium," *Domus* 11, no. 65 (May 1933), 276, [http://www.casadellarchitettura.eu/fascicolo/data/2011-02-18\\_430\\_1635.pdf](http://www.casadellarchitettura.eu/fascicolo/data/2011-02-18_430_1635.pdf) (accessed June 13, 2017).

<sup>33</sup> Maria Teresa Parpagliolo, "Hannover, città nel verde: Un esempio di moderna urbanistica," *Le Vie del Mondo: Rivista mensile della CTI* 6, no. 3 (March 1938).

<sup>34</sup> Marcello Piacentini et al., "L'esposizione Universale di Roma 1942," *Architettura* 17, special number (December 1938), 721–24, [http://www.casadellarchitettura.eu/fascicolo/data/2011-02-07\\_321\\_1373.pdf](http://www.casadellarchitettura.eu/fascicolo/data/2011-02-07_321_1373.pdf) (accessed June 13, 2017).

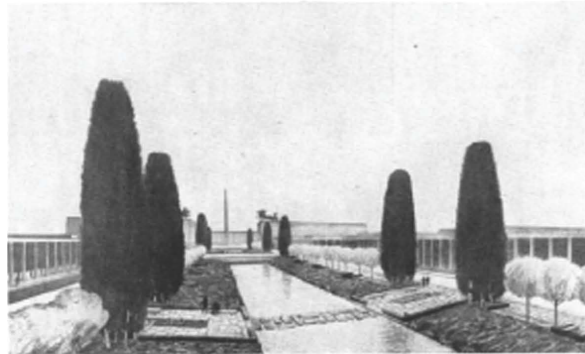
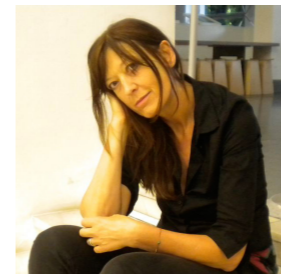

Fig. 7. Sketches of Belvedere, Avenue of the Corporations and Parkzone, in "Parchi, giardini, viali alberati nell'E42," in Marcello Piacentini et al., "L'esposizione Universale di Roma 1942".

Published in *Architettura* 17, special number (December 1938), 826.

In the first part of her professional experience, Parpagliolo's communication skills activated a break with tradition to experiment with new forms in garden design, parkways and community gardens. She also contributed as a pioneer to establish landscape architecture as a new specific discipline. Having considered women's participation in architecture since the early twentieth century, it can be said that we have seen works mostly realised in exhibition occasions, and that were innovative both in the architectural and the social settings. Women architects, through their actions and their lives, contributed as pioneers to redefine professional identity and the boundaries of achievement in architecture. Even if their numbers were few, the works of pioneer women architects have had a profound and still unknown impact on modern history. The opportunities to emerge were limited for them, and their position in the architectural hierarchy was more often than not on the lower rungs of the professional ladder, but they strongly changed the idea of living, working, and learning, have fun, even if sometimes their works remained under the tradition of misattribution.

### Lucia Krasovec Lucas Politecnico di Milano



Lucia Krasovec Lucas is an architect, has a PhD in urban and architectural investigations, and is a contract professor in the Faculty of Architecture at Politecnico of Milano since 2002. She focuses on the urban, landscape and environmental field and their re-definition with integrated projects in small and large scale. She has been involved in EU programs as Phare Cross- Border Project, Interreg, Ecos-Ouverture. Her practice's expertise includes Architecture, Masterplanning, Urban Design, Space Planning, Interior Design, Building Approval, Graphic Design and Project Management. Her approach to the space filters out the research of the image and the patterns of it in a deep contamination with different disciplines, including art and experimental visualization, on account of the importance of a good communication and information of visions especially strong in the public space main themes. She is President of the national board of AIDIA, Association of Italian Women Engineers and Architects, and co-founder of AIDIA Trieste.

E-mail: [lucia.krasovec@polimi.it](mailto:lucia.krasovec@polimi.it)

## How Wide is the Gap? Evaluating Current Documentation of Women Architects in Modern Architecture History Books (2004–2014)

Four decades ago, Susana Torre addressed the lack of documentation and representation of women's design and built achievements in architectural histories. This article contributes to the current criticism of the lack of documentation of women's contributions to architectural histories. To evaluate the historical visibility of women since Torre's first addressed of the issue, this article provides a quantitative analysis of the documentation of women and their achievements in recent publications. The titles examined were 10 modern architecture history books, accompanied by an index, published or re-printed between 2004-2014 and available in Belgian university libraries. Only those available in at least three institutions were investigated, and those with multiple copies available were prioritised. The outcome of this research is two-fold. Firstly, it demonstrates that modern architecture histories were composed of an averaging ratio of 19 men architects/designers to one woman architect/designer. Secondly, inspired by the three-question Bechdel test that evaluates women's representation in film, an architectural Bechdel test was introduced and put into practice to evaluate the representation of women's lives and achievements. Only four out of the ten books were shown to represent the lives and/or achievements of one woman architect in at least three pages.

Keywords: women, modern architecture documentation, quantitative study, recent publications

### Introduction

Low representation of women is a problem in the practice of architecture today. This will only be exacerbated by an inaccurate account of architecture history. Perpetuating an exaggerated gender gap can discourage women from entering and remaining in the profession. In 2014, a survey covering 97% of architects in Europe showed that the collective average of women practicing architecture was 39%.<sup>1</sup> The same European survey stated that women architects earned 67 cents to a man's euro. This suggests that women are not valued equally in the profession. Moreover, architects tend to earn the most when they are above fifty years-old but, according to the 2014 report, only one woman for every six men reaches this higher recognition. One may wonder, are women architects being discouraged from the profession due to a lack of recognition?

In 1977, Susana Torre addressed the lack of documentation and representation of women's design and built achievements in architectural histories. Torre asked, 'Why, although women have designed and built since the beginning of human civilization, have their achievements remained undocumented and unacknowledged in architectural histories?'<sup>2</sup> Are women's achievements still undocumented and unacknowledged in the modern architecture records? Is this gap between women's achievements and what is written in the canon history books still significant today? If such gap still exists, one may wonder how wide is the gap?

In the last forty years, several architectural historians and theorists have examined the work and lives of modern women architects and designers. They have disseminated and proliferated their findings through exhibitions and exhaustive publications<sup>3</sup> thus, providing the tools to revisit the history of

- 1 'Country profiles' in: 'The Architectural Profession in Europe 2014 – ACE Sector Study, 2014,' Architects' Council of Europe, [http://www.acecae.eu/fileadmin/New\\_Upload/7.\\_Publications/Sector\\_Study/2014/EN/2014\\_EN\\_FULL.pdf](http://www.acecae.eu/fileadmin/New_Upload/7._Publications/Sector_Study/2014/EN/2014_EN_FULL.pdf) (accessed June 16, 2017), research done by Mirza & Nacey Research Ltd, January 2015.
- 2 Susana Torre (ed.), *Women in American Architecture: A Historic and Contemporary Perspective: A Publication and Exhibition* (New York: Whitney Library of Design, 1977).
- 3 Diana Agrest, Patricia Conway and Leslie Kanes Weisman (eds.), *The Sex of Architecture* (New York: Harry N. Abrams, 1996); Lori A. Brown, *Feminist Practices: Interdisciplinary Approaches to Women in Architecture* (Farnham: Ashgate, 2011); Ulla Markelin, *Profles: Pioneering Women Architects from Finland* (Helsinki: Museum of Finnish Architecture, 1983).

modern architecture and to correct inaccuracies about collaborative projects previously thought to have been individually created. These updated, detailed studies have given modern architecture a new face in a history that does not omit the presence of women. They have 'unforgotten' great architects like Charlotte Perriand, Lilly Reich and Marion Mahony Griffin.<sup>4</sup> It seems thus necessary today to evaluate the impact of their work. If historians have included women architects, to what extent did they?

The outcome of my research is twofold. Firstly, I present the statistics for total individuals recorded, focusing on those appearing on more than one page or illustration. Secondly, these page-citations are supported with an analysis of the representation of women architects' lives and achievements.

## Methodology

This article provides a quantitative and qualitative content analysis of the documentation of women's achievements in modern architecture history publications. This research paper is divided in two parts.

The first concerns the quantification of people named in book indexes who were assigned an individual and documented role in the history of architecture. I am interested in the individuals who are attributed a singular role and individual recognition. By examining book indexes and counting the page citations, a female-to-male ratio of represented individuals can be demonstrated. Because this conference focuses on the period of 1918–45, statistics and information about women architects working in this period will be included.

The second part addresses the way in which women modern architects are included in these books. This was done by creating an architectural Bechdel test through which the books were examined. The Bechdel test is a three-question



Fig. 1. Extract of original comic strip by Alison Bechdel titled 'The Rule' in her *Dykes to Watch Out For*, 1985, p. 22. Copyright belongs to Alison Bechdel.

test developed by cartoonist Alison Bechdel in 1985 to analyse the representation of women in film (Fig. 1).<sup>5</sup> In order for a film to pass the test, it needs to fulfil the three following requisites.<sup>6</sup> Firstly, the film has to have more than two named female characters that, secondly, talk to each other; and thirdly, talk about something other than men. The goal of this test is to draw attention to the lack of women represented in film and to illustrate how they are represented. The last question points to the way women characters are written only to promote the stories of other men characters.

The architectural Bechdel test is further explained in part two of this article. This test was done with the support of a supplementary quantitative method. By counting the pronouns he, she, his, her and him employed in the English version of the text, it was possible to illustrate how women architects' lives and their achievements are portrayed in these books. This step was accomplished with digital, English versions of the books examined (Google books and ebooks). This quantification enabled an evaluation of the extent to which gender pronouns, in the English translations of the text, refer to women architects; thus, a form of quantification of the representation of women's lives, achievements and ideas described in such publications.

## The Ten Titles Analysed

Ten books were analysed for this research. They were selected according to five criteria.

- (1) Only books published in the last decade were studied (from 2004–14).
- (2) All books were available in more than one architecture library at Belgian universities. Books in multiple copies, languages or editions were preferred.
- (3) Titles had to contain the words 'modern architecture' or '20th century architecture'. This was designated in order to examine what is perceived as 'generally noteworthy' or the canon of modern architecture. There was one exception to this guideline in incorporating the title *Negotiating Domesticity* edited by Gülsüm Baydar and Hilde Heynen. This was deliberately done in order to compare the effect of gender-aware architectural theory and history books.
- (4) Books geographically focused were excluded from the research in order to represent the perceived world's canons and the 'general' history of modern architecture.
- (5) Finally, all books had to include an index of the individuals mentioned within the pages of the literary work.

4 Charlotte Benton, *Charlotte Perriand: Modernist Pioneer* (London: Design Museum, 1996); Mary McLeod, *Charlotte Perriand: An Art of Living* (New York: Harry N. Abrams, 2003); Matilda McQuaid, *Lilly Reich, Designer and Architect* (New York: Museum of Modern Art, 1996); Debora Wood, *Marion Mahony Griffin: Drawing the Form of Nature* (Evanston, IL: Mary and Leight Block Museum of Art, 2005).

5 Glyn Davis et al., *Film Studies: A Global Introduction* (London: Routledge, 2015), 462.

6 Alison Bechdel, "The Rule," in *Dykes to Watch Out for* (Ithaca, NY: Firebrand Books, 1986).

The ten titles of the books studied are: *Encyclopedia of 20th Century Architecture* (2004); *Negotiating Domesticity: Spatial Productions of Gender in Modern Architecture* (2005); *L'Architecture du XXe siècle* (2005); *Modern Architecture and Other Essays* (2005); *L'architecture moderne* (2006); *The A-Z of Modern Architecture* (2007); *Modern Architecture: Representation & Reality* (2009); *La arquitectura moderna y sus creadores* (2012); *20th Century World Architecture* (2012); and *Modern Architecture: A Critical History* (2014).

Then ten publications here studied are not all aimed for the same audiences. Some are intended for scientific audiences, some contain subjective essays on modern architecture, and others claim to be encyclopaedic accounts of modern architecture. A strict distinction was not made for two reasons. Firstly, scholars have praised these ten books as being accurate representations of history, also using them as scientific references in their own academic publications. Secondly, these books were found in university libraries, presented with the same treatment and in the same shelves for modern architecture history sources.

### Part One: The Statistical Results

All the ten titles add up to 6985 pages recording the history of modern architecture. After analysis, a total of 3490 individual names were extracted from the indices. Of the total number of people mentioned, 342 were female (10%) to 2936 male (90%) (Fig. 2). Of the 3490 people indexed, 1574 (45%) are mentioned on more than one page or illustration. Since more than 50% of the individuals indexed are only used once as literary references that are unique to one title, I propose to study the statistics of those individuals that are mentioned more than once: in the same book or just once but in more than one book. These 1574 individuals would be portrayed as significant contributors to modern architecture.

Of these individuals cited, 144 (9.1%) are women and 1429 are men (90.9%); 1063 are architects and designers (67.5%); 116 artists (7.4%) and 95 historians (6%). Furthermore, of these 1063 architects and designers, appearing on more than one page, 61 are female (5.7%) to 1002 male (94.2%). Subsequently, of the 61 women, 24 are recorded architects or designers who were active in the profession between 1918 and 1945. Finally, we can produce the ratio of female to male architects or designers, documented in two or more pages or illustrations and being active during 1918–1945, to be 24 women (4.6%) to 490 men (95.3%). This is an extremely low ratio, especially given that out of the ten most cited architects, as recorded in this analysis, more than half had significantly collaborated with women architects and designers.

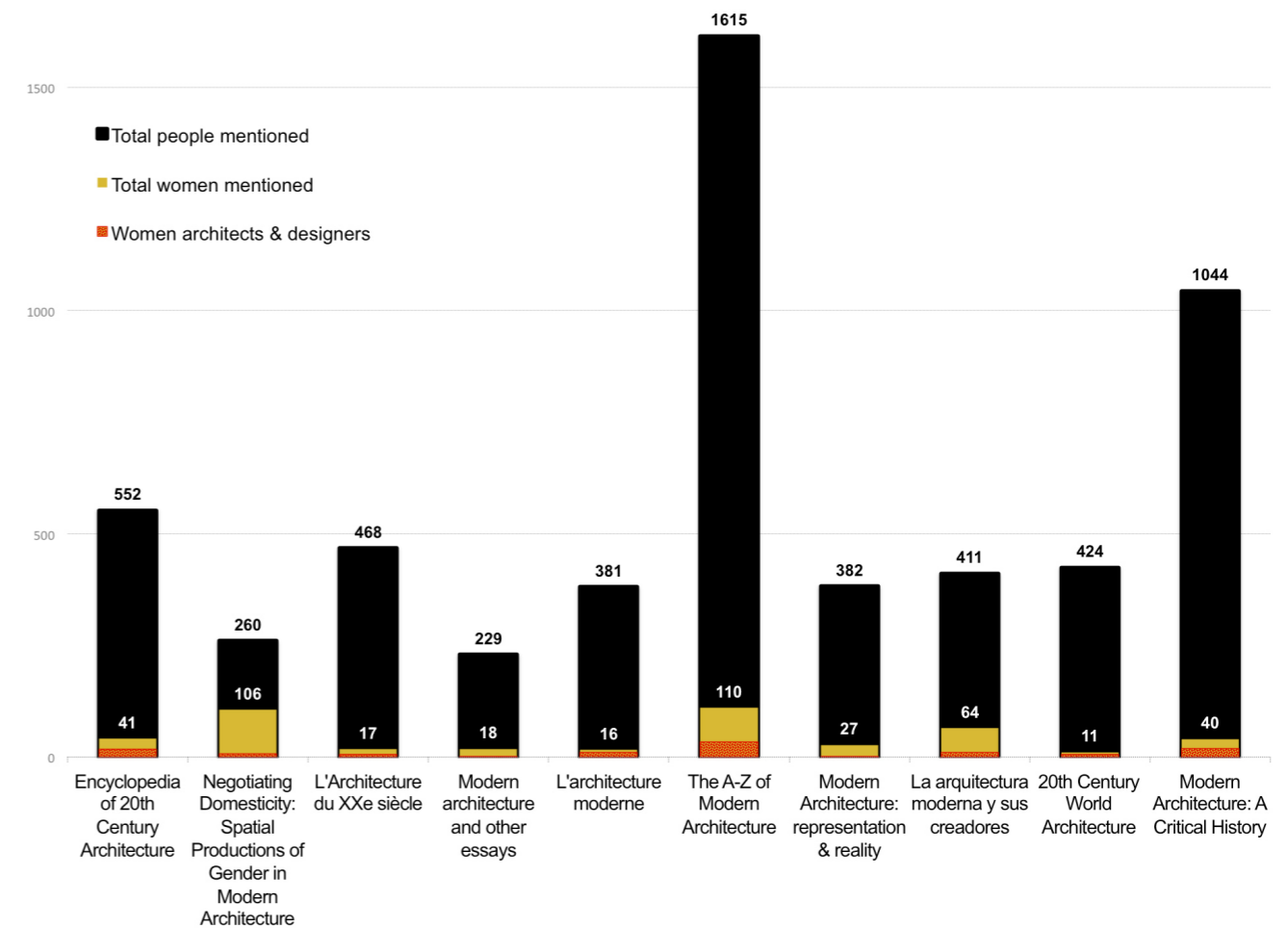

Fig. 2. Chart of all the names mentioned in the indexes of the ten titles

### Part Two: The Torre Test

Six out of the ten most cited architects,<sup>7</sup> in this recently published Euro-American literature, collaborated and some even partnered with fellow female architects and designers for their most celebrated work. However, only two women are present in the top 100 most cited architects (Fig. 3). Furthermore, when women collaborators or partners are described in this historical literature, they are almost never presented as equal architects or designers but rather as drafters, assistants or even just simply as wives. How do we account for this discrepancy? Why are men and women not equally portrayed by historians? It is imperative for architectural history to reflect reality but most of all, it is important that the future of architecture is projected from accurate histories.

<sup>7</sup> After adding up total counts of page citations, across the ten studied publications a top ten of most cited architects was found. The top ten most cited architectes are, in order of page-mentions: Le Corbusier (Charlotte Perriand), Frank Lloyd Wright (Marion Mahony and Catherine Ostertag), Ludwig Mies van der Rohe (Lily Reich), Louis Kahn (Anne Tyng), Walter Gropius, Robert Venturi (Denise Scott Brown), Louis Henry Sullivan, Philip Johnson, Alvar Aalto (Aino Marsio-Aalto), and Adolf Loos.

# SIX OUT OF THE 10 MOST CITED ARCHITECTS COLLABORATED WITH WOMEN

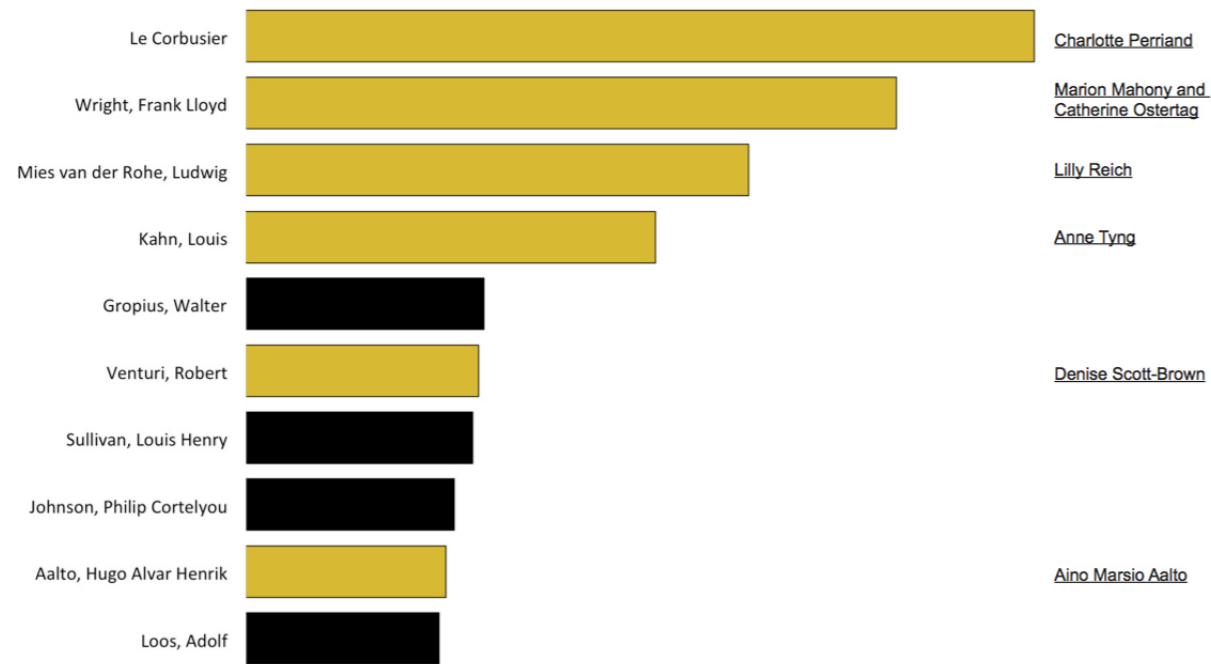

Fig. 3. Chart representing the top ten most cited architects in the ten titles analysed.



Fig. 4. Results of the "Torre test".

	TOTAL PAGES	TOTAL WOMEN ARCHITECTS & DESIGNERS	TOTAL WOMEN ARCHITECTS & DESIGNERS, >1 PAGE	1ST TORRE CONDITION	2ND TORRE CONDITION	3RD TORRE CONDITION
1. Encyclopedia of 20th Century Architecture	1525	34	24	✓	✓	✓
2. The A-Z of Modern Architecture	1071	103	9	✓	✓	✓
3. 20th Century World Architecture	831	10	1	✓	✓	✗
4. L'architecture du XXe siècle	604	16	9	✓	✓	✗

Fig. 5. The representation of women architects in Group A.

The architectural equivalent of the Bechdel test that I propose will need to comply with the three following statements. (1) The book contains more than three women architects or designers, named individually in the index. (2) One of the women architect's projects, productions, ideas or experiences are mentioned (3) in more than two pages of the whole book. I name this adapted architectural Bechdel test the Torre test, in honour of Argentinian scholar Torre and her pioneering contribution to recognising women in architecture with her 1977 publication, in a defining time when history started being written with a conscious perspective of gender biases.<sup>8</sup> Six out of the ten books fail this simple test (Fig. 4).

For the purposes of clarity, the books will be separated into three groups according to their number of pages. Group A will include the books with over 450 pages. Group B will include books between 300 and 450 pages. Finally, Group C will include the books with less than 300 pages.

### Group A

This group is composed of four books that aim at a lengthier narrative of history, replicating the form of encyclopaedias. Figure 5 illustrates the results for their representation of women architects (Fig. 5).

#### 1. Sennott, *Encyclopedia of 20th Century Architecture, Volume 1-3*. New York: Fitzroy.

This title is an extensive historical encyclopaedia composed of three volumes and 1525 pages.<sup>9</sup> There are 553 individuals mentioned and almost half of them (266) are mentioned multiple times. This suggests an average of 2.7 pages per individual, which allows for a more extensive historical account of the lives and works of the architects and designers. One also observes a higher number of female (26 she and 35 her) and male pronouns (88 he, 89 his and 74 him) used in the text. This is

<sup>8</sup> Torre, *Women in American Architecture*.

<sup>9</sup> R. Stephen Sennott, *Encyclopedia of 20th-Century Architecture* (New York: Fitzroy Dearborn, 2004).

also reflected by extensive descriptions of women architects and their contributions, thus passing the Torre test.

*Encyclopedia of 20th Century Architecture* represents the second highest use of female pronouns. Due to the encyclopaedia format, each entry of a woman architect presents a detailed account of who they were and what they accomplished. This above average representation of women architects may be due to the involvement of the feminist architect and historian Diana Agrest, as she was part of the board of advisors.<sup>10</sup> A particularity of this book, which increases the visibility of the women architects, is that there is an index entry on this topic: titled 'women architects,' which is followed by a reference to the page mentions of nine prominent women architects.

The theme of women in architecture is also treated throughout the three volumes of the encyclopaedia. For example, on the 'Finland' entry there is a two-paragraph description of prominent early 20th century women architects. Along with two other Finnish women architects, Vivi Lönn is presented. She is noteworthy for being the first female architecture graduate in 1896 and the first independently practicing female architect of Finland in 1904.<sup>11</sup> In page 460 of this encyclopaedia, she is presented as a 'major force' in the architecture of the first two decades of the country. Her most prominent buildings are also subsequently referenced without elaboration. This book has a 7.43% female name citations in its index. Even with a low percentage, this book is noteworthy in elaborating in higher detail the lives, production and trajectories of 41 women.

## 2. Gössel and Cohen, *The A-Z of Modern Architecture*. Cologne: Taschen.

This book, consisting of two volumes with illustrated projects, represented the highest number of women mentioned (110), and the highest number of women architects mentioned (103).<sup>12</sup> Some of the wives that collaborated with their partners are given a name and sometimes a face. This reference book is effective in representing the high numbers of women that have contributed to the field of architecture as a whole in the twentieth century. It may be because it is taken more as a detailed encyclopaedia than as a free-flowing writing piece. Even though many women are cited in this book, very few are actually presented or cited on more than one page of the book.

Some of the architect wives of men architects are for the first time present in this book. However, they are not represented equally compared to their husbands. For instance, Herzog and De Meuron both appear in the same number of pages. For example, the Finish modernist architect Aino Marsio Aalto (1894–1949) is here mentioned for the first time on her own in the index, however, she is not given her own entry in the content of the book. Nonetheless, this is the only time in all ten books

<sup>10</sup> Ibid.

<sup>11</sup> Annie Canel and Ruth Oldenziel, *Crossing Boundaries, Building Bridges* (London: Routledge, 2005), 82.

<sup>12</sup> Peter Gössel and Jean-Louis Cohen, *The A-Z of Modern Architecture* (Köln: Taschen, 2007).

researched that she appears in the index individually. Aino Aalto graduated in 1920, a year before Alvar and with the same architecture degree from the Institute of Technology in Helsinki.<sup>13</sup> She collaborated as an equal partner with her husband, as well as designing on her own.

Surprisingly, the projects that she produced alongside Alvar Aalto are cited in 8 out of the 10 books, with the top 10 highest amounts of page citations in all of the books. The projects and designs Aino Aalto produced with her partner are well recognized and admired but she does not receive any credit for them. On the other hand, Alvar Aalto, who is one of the most described figures of modern architecture, appears in more than 140 pages of all of the books analysed. In this way, it is her husband that is credited as the sole author of the projects that they both collaborated on.

However, Irish architect Eileen Gray's (1878–1976) life and achievements are described on more than one page of the book. It is only thanks to the Peter Gössel and Jean-Louis Cohen mentioning her in three pages that this book passes the Torre test.

## 3. Terragni and Thomas, *20th Century World Architecture*. London: Phaidon.

This book was edited by two women historians, Emilia Terragni and Helen Thomas, and it has the lowest women representation out of the ten titles.<sup>14</sup> There are only 10 individual women architects cited in the index at least once. Women represent a very low 2.6% of the 424 people cited. The lives or works of women architects are not recorded in this 831-page book. This title was praised upon reception for its accuracy, exhaustiveness and inclusiveness of modern architects from non-Western parts of the world. For example,

The reality, needless to say, was more complicated, and now Phaidon have devoted several kilogrammes of book to putting the record straight. *20th-Century World Architecture* is a coffee-table book that weighs more than a table, an epic production that boasts its scale: 3,800 photographs of 757 buildings by 699 architects in 97 countries. It aims to set architecture in wider contexts of colonisation and decolonisation, and of cultural exchanges between countries.<sup>15</sup>

Despite this title aspiring to represent 20th century world architecture, it exhibits a case for discrimination. There are female partners that are completely overlooked and whose respective husbands or partners are not (ie. Aino Marsio-Aalto, Nobu Tsuchiura, Charlotte Perriand, Denise Scott-Brown, etc.) There are also several female architects that are overlooked as individuals

<sup>13</sup> Alvar Aalto, Aino Aalto and Renja Suominen-Kokkonen, *Aino and Alvar Aalto: A Shared Journey: Interpretations of an Everyday Modernism* (Helsinki: Alvar Aalto Foundation, 2007).

<sup>14</sup> Emilia Terragni and Helen Thomas, *20th-Century World Architecture* (London: Phaidon, 2012).

<sup>15</sup> Rowan Moore, "20th-Century World Architecture: The Phaidon Atlas by Phaidon Editors; The Future of Architecture Since 1889 by Jean-Louis Cohen – Review," *The Guardian*, October 28, 2012, <http://www.theguardian.com/books/2012/oct/28/architecture-atlas-phaidon-review> (accessed June 16, 2017).

but who are partially mentioned as office names or together with their husbands such as Marion Mahony Griffin, Ray Eames and Helena Syrkus.

A surprising example is the case of Lina Bo Bardi (1914–1992) whose projects are presented in three different pages but the architect is barely mentioned in them.<sup>16</sup> She is firstly introduced as Gio Pionti's student and then the authors proceed to describe her home, the *Glass House* (1951), as an excellent representation of his theories and not hers. Subsequently, when presenting Bo Bardi's project for the *Museum of Art* in São Paulo, the narrators only focus on the husband of the architect, Pietro Maria Bardi. They describe his role in the museum, his networks and his curatorial experience. Her name is only mentioned in the last sentence of the page, to remark her unusual choice in presenting the artwork freely in the space. Finally, only in the project of the *Pompéia Factory Leisure Center* is Bo Bardi's motto 'Architettura povera' cited. However, her unique parti pris for renovating the factory, instead of following through with the planned demolition of the site, is also ignored. This title fails the Torre test because Bo Bardi's life and ideas are not described for more than one page and her projects are presented in such a way that they do not appear to be her own.

#### 4. *L'Architecture du XXe siècle*. Cologne: Taschen.

Multiple copies, editions and language versions of this book were available at all university libraries. The version analysed here is a French translation and second edition of the book published in 2005, a newer version has been published in 2012.<sup>17</sup> However, it is the 2005 edition that was most widely available, in multiple copies, across multiple institutions. This book contains 604 pages of text, with an index presenting a total of 468 people with 17 referenced women. Thus, one can observe a 3.6% representation of women in this notorious reference of modern architecture history. However, this book blatantly fails the Torre test.

When analysing the use of gender pronouns in the English version of the 2005 edition, a great discrepancy stands out. There are a total of 189 male pronouns (83 he, 85 his and 21 him) employed in the text. However, there are absolutely no mentions of she pronouns. This can be translated as: there are zero sentences where women are active subjects in the history of modern architecture. Furthermore, there are only five uses of the pronoun her. Of the five, only two refer to human beings: British-Iraqi architect Zaha Hadid and American-French artist Josephine Baker, as a fantasy client. The other three her pronouns refer to anthropomorphised nature. Zaha Hadid's name appears in text in two sentences of the whole book. Once in the descriptor of a photograph of her *Vitra Fire Station* (1989–1993) and once when describing the profile of architect Daniel Libeskind.<sup>18</sup> In this

	TOTAL PAGES	TOTAL WOMEN ARCHITECTS & DESIGNERS	TOTAL WOMEN ARCHITECTS & DESIGNERS, >1 PAGE	1ST TORRE CONDITION	2ND TORRE CONDITION	3RD TORRE CONDITION
5. <i>La arquitectura moderna y sus creadores</i>	407	17	8	✓	✓	✓
6. <i>Modern Architecture and other essays</i>	400	6	5	✓	✓	✗
7. <i>Modern Architecture: A Critical History</i>	389	25	17	✓	✓	✗
8. <i>Modern Architecture, representation &amp; reality</i>	364	5	3	✓	✗	✗

Fig. 6. The representation of women architects in Group B.

way, her life and work are not included in the body of the book and are not described for at least three pages.

A particularity of this book is that it contains a section detailing twenty architects: as individuals or as duos. Sadly, no women are represented. It insinuates that no women architects were worth being remembered or that their work was not remarkable enough in the history of 20th century architecture. This particular chapter, that appears at the end of the book, also provides a biography of the architects, accompanied by large photographs of the architects mentioned. Because this selection is not explained/motivated in the introduction or the text, one is left wondering, why these twenty? Why only white Western men?

#### Group B

This group is composed of four books written by one author aiming to portray abridged overviews of modern architecture history, some of them are a compilation of essays. Figure six illustrates the results for their representation of women architects (Fig. 6).

#### 5. *Filler, La arquitectura moderna y sus creadores*. First edition, Spanish translation. Barcelona: Alba.

This book is a composition of articles published online for the 'The New York Review of Books' that was re-edited for the book publication. These articles dating from 1985 to 2007 were edited together in the last 8 years and the author took advantage of the time to include more female architects. Martin Filler narrates history for a wider audience, attempting to include references to popular culture figures (Marilyn Monroe, Judy Garland, Jacqueline Kennedy) as well as political figures (Robert Kennedy, Saddam Hussein and George W. Bush).<sup>19</sup> However, there is no bibliography or footnotes supporting this book, which makes one question its scientific validity.

<sup>16</sup> Terragni and Thomas, *20th-Century World Architecture*, 722, 728, 732.

<sup>17</sup> Peter Gössel and Gabriele Leuthäuser, *L'architecture du XXe siècle* (Köln: Taschen, 2005).

<sup>18</sup> Gössel and Leuthäuser, *L'architecture*, 524, 585.

<sup>19</sup> Martin Filler, *La arquitectura moderna y sus creadores* (Barcelona: ALBA Editorial, 2012).

This publication passes the created Torre test, given that women architects are present in the index and a woman architect's life is partially described through multiple pages. However, this doesn't prevent this work from undermining women's contributions to architecture. The author acknowledges that Margaret Macdonald (1864–1933) had been 'forgotten' by many historians and academics, even citing the work of feminist historian Janice Helland. However, he discredits the collaboration of the couple.

Pamela Robertson, an expert on Charles Mackintosh, cited in 2001 one of the letters Mackintosh addressed to Macdonald, his wife, as recognition of her contribution.<sup>20</sup> Charles Mackintosh wrote, 'you must remember that in all my architectural efforts you have been half if not three-quarter in them.' However, Filler does not as recognise her efforts. For example on page 44, he questions the fact that both Macdonald's and her husband's initials appear as authors of both of their work. He raises doubts about Macdonald's contributions to the architectural office by adding: 'Scholars debate whether this meant actual collaboration, concept inspiration, or merely, in the case of his series of botanical watercolours (...), her proximity when he painted them.'

Here, Margaret is reduced to the role of an object that appeared to be sharing the same space as the male-genius in the room. On page 207, Marion Mahony is also discredited for her architectural contributions, being only mentioned once, as Frank Lloyd Wright's draftsman and not as the registered architect that she was.

#### 6. Scully, *Modern Architecture and Other Essays*. New York: Princeton Press.

This book contains an introduction by Neil Levine that describes the life of the author, the architectural historian Vincent Scully, and multiple chapters that are essays previously written by Scully and compiled by Levine.<sup>21</sup> This is not, thus, an encyclopaedia but it does aim to portray a personal overview of modern architecture. There are 18 women out of 381 people cited in the index of this book. However, three of the women indexed are mentioned only once, in the biographical introduction, and only because they were wives or ex-wives of the author. It is surprising that the three indexed women (Nancy Keith Scully, Catherine Lynn Scully and Marian LaFollette Wohl) were, and are, involved in the academic world of art and architecture history but were not included in this book for their accomplishments but as biographical information of Vincent Scully.

There are fewer references to other authors and more focus on a small number of figures. In a way, it almost appears to be too subjective as most of the author's cited architects are rooted in the same country as the author and external scientific referencing is scarce throughout the book.

<sup>20</sup> Charles Rennie Mackintosh and Pamela Robertson, *The Chronycle: The Letters of Charles Rennie Mackintosh to Margaret Macdonald Mackintosh, 1927* (Glasgow: Hunterian Art Gallery, University of Glasgow, 2001), 18.

<sup>21</sup> Vincent Scully, *Modern Architecture and Other Essays* (Princeton: Princeton University Press, 2005).

This is due to the nature of the writing being in essay form. For example, very high page mentions are given to the architect Louis Khan, who is much less referenced in the other books. There is one woman architect, Elizabeth Plater-Zyberk (1950), who is mentioned in more than three pages but always as an accessory to her husband, and her own life and accomplishments are not described for more than one page. Denise Scott-Brown is the other one mentioned in more than three pages but again, as an accessory to her husband and her own life and accomplishments are not described.

There are a total of 30 female gender pronouns employed in this book. There are nine instances where the pronoun she is employed. These are in reference to the following: one for a client of a home (Vanna Venturi), one for a religious story mentioning the Virgin of the Belle, two for an Egyptian mummy story (no name), two for anthropomorphized countries of France and England, one for the dead wife of a king (no name), two for the mother of Frank Lloyd Wright (no name), and finally one for Catherine Bauer who is not included in the index of persons mentioned. This book fails the Torre test.

#### 7. Frampton, *Modern Architecture: A Critical History*, 4th revised edition. London: Thames and Hudson.

This book had a very large index (1044 individuals) considering that it is comparatively small in size, 389 pages.<sup>22</sup> This creates a higher density of name citations per page, resulting in less detailed information about one-person, but more individual contributions recorded. This produces a more inclusive history of architecture with large numbers of individuals and not just the too-well-known heroes (cf., Le Corbusier, Frank Lloyd Wright, Mies van der Rohe, etc.).

Although the numbers of people mentioned are higher, the number of women represented is not proportionally higher. Designers, interior architects, and architects that happen to be women are only mentioned once and only in the context of their couple. For example, the designer and artist Noémi Pernessin is mentioned only once (p. 258). Her name appears as a second subject, not the first, and it used as a descriptor of her husband and not as a stand-alone citation. This is her only mention. In contrast, her husband, Antonin Raymond is mentioned as the main subject in multiple pages (257–8, 259). By mentioning only him as a subject, Frampton implies that Pernessin's contributions were negligible. This is in contrast with historians who have examined the biography of the couple and attribute to Noémi Pernessin an equal role of influencing, economically supporting, and directing her husband's work.<sup>23</sup>

<sup>22</sup> Kenneth Frampton, *Modern Architecture: A Critical History* (London: Thames and Hudson, 2013).

<sup>23</sup> Kurt Helfrich and William Whitaker, *Crafting a Modern World: The Architecture and Design of Antonin and Noémi Raymond* (Princeton: Princeton Architectural Press, 2006), 16–17.

This tendency of mentioning the woman collaborator only as an accessory to a male counterpart is repeated several times throughout the whole text,<sup>24</sup> thereby failing the Torre test.

### 8. Levine, *Modern Architecture: Representation & Reality*. Yale Press.

This book, written by Neil Levine, is a compilation of his lectures given at the University of Cambridge in the academic year of 1994.<sup>25</sup> In this way, the content of this book dates back to a time when several other feminist historians were publishing books and organising conferences on women's contribution to modern architecture.<sup>26</sup> However, this book does not seem to have been impacted by these contributions. The author, Levine, reviews three centuries of architecture, dating the beginning of modernity to the Italian architect Alberti in the mid-fifteenth century. This would provide for many years of history where women also theorised and took part in the practice of building.<sup>27</sup> Nonetheless, there are 27 women cited in this book as opposed to 353 men.

There are a total of 31 female gender pronouns (9 she and 22 her) employed in the text against a total of 225 (87 he, 85 his and 53 him) male gender pronouns. Only five women architects are cited and none of them were working during the period of 1918–45. The only two women architects cited more than twice are Denise Scott Brown (1931) and Cammie McAtee (1966). They are mostly used for literary references and their life and work are not described either.

A review by historian Kenneth Frampton describes the author as an outstanding architectural historian of his generation. It sates,

This is Levine at his critical best and it is this, surely, that puts him in a class apart as far as the architectural historians of his generation are concerned, since his writing not only manifests profound erudition and logical judgment but also exhibits an exceptional capacity to perceive and interpret the spatial and technostatic feeling of a given architecture...<sup>28</sup>

Even though, *Modern Architecture: Representation & Reality* is a critically acclaimed book, appreciated by fellow historians,<sup>29</sup> it fails the Torre test.

<sup>24</sup> Lilly Reich (p. 163), Eileen Gray (p. 334), Margaret MacDonald (p. 74), Gertrud Jekyll (p. 50), Gunta Stölzl (p. 128), Catherine Ostertag (p. 62) and more.

<sup>25</sup> Neil Levine, *Modern Architecture: Representation and Reality* (New Haven Conn.: Yale University Press, 2010).

<sup>26</sup> Agrest, Conway and Weisman, *The Sex*; Beatriz Colomina (ed.), *Sexuality and Space* (Cambridge: MIT Press, 1992); Dolores Hayden, *The Grand Domestic Revolution: A History of Feminist Designs for American Homes, Neighborhoods, and Cities* (Cambridge: MIT Press, 1982); Leslie Kane Weisman, *Discrimination by Design: A Feminist Critique of the Man-Made Environment* (Champaign: University of Illinois Press, 1994).

<sup>27</sup> For example Katherine Briçonnet (1495–1526). See: Alberto Gisholt Tayabas, "De la mujer en la arquitectura, una reflexión histórica," *Bitácora arquitectura* 33 (2016), 80–85.

<sup>28</sup> Kenneth Frampton, "Modern Architecture: Representation and Reality," *Journal of the Society of Architectural Historians* 4 (2012), 552–55.

<sup>29</sup> Jack Quinan, "Modern Architecture: Representation & Reality," *Choice* 3 (2010), 489.

	TOTAL PAGES	TOTAL WOMEN ARCHITECTS & DESIGNERS	TOTAL WOMEN ARCHITECTS & DESIGNERS, >1 PAGE	1ST TORRE CONDITION	2ND TORRE CONDITION	3RD TORRE CONDITION
9. <i>L'architecture moderne</i>	336	10	1	✗	✗	✗
10. <i>Negotiating Domesticity: Spatial Produc...</i>	322	20	5	✓	✓	✓

Fig. 7. The representation of women architects in Group C.

### Group C

This group is composed of two books of a shorter length, aimed at a scholarly audience. Figure 7 illustrates the results of their representation of women architects (Fig. 7).

### 9. Colquhoun, *L'architecture moderne*. Gollion: Infolio.

This book was available across all university libraries with more than one copy, in numerous editions and in more than one language. The version analysed here is a 2006 paperback French translation of the 2002 edition of *Modern Architecture* by Alan Colquhoun.<sup>30</sup> Many of the books researched here made reference to this book as a scientific source of merit. There are 366 pages and 16 women that are mentioned in the index. This figure is the second lowest out of the 10 books. This book also fails the Torre test.

The pronoun her appears on two pages out of 366. On page 26, it is used to reference anthropomorphised nature. On the page 275, her is used to reference Catherine Bauer. The only she pronoun also appears on that same page. Both pronouns are used to reference the same housing expert and architectural educator. Bauer is the only woman architect described in the book; although only in less than five sentences. She is first introduced as Lewis Mumford's assistant and later as his 'tour partner.' On page 275, Bauer is also described as a writer, a 'transformed housing reformer', and an expert on social housing. However, Bauer was also a regional planner, part of the US Government Housing Authority and contributor to the United Nations urban development programs. She had been one year away from graduating with an architecture degree at Cornell University but graduated with an English degree from Vassar College instead. Bauer was also a professor and the Dean of the Environmental Design College at the University of California Berkeley.<sup>31</sup>

Household rationalist and designer Christine Frederick is also cited once, accompanied by two women that appear here as literary authors (household designer Erna Meyer and Austrian architect Margarete Schütte-Lihotzky). In two concise sentences, the historian describes the significance of

<sup>30</sup> Alan Colquhoun, *L'architecture moderne* (Gollion: INFOLIO, 2006).

<sup>31</sup> Barbara Sicherman, *Notable American Women: The Modern Period: A Biographical Dictionary* (Cambridge: Harvard University Press, 1980), 66–68.

the women's movement's influence in promoting new concepts of the domestic management (that greatly inspired celebrated modernist architects). These three household rationalists and designers are mentioned by name, in one page of the whole book. However, no context is given as to why their collective work would be remarkable in the theory of architectural history. Their life, ideas, and architectural works are overlooked.

#### 10. Heynen and Baydar, *Negotiating Domesticity: Spatial Productions of Gender in Modern Architecture*. London: Routledge.

This book represents the most equitable ratio of female to male individuals referenced (41% to 59%), with 106 women out of 260 individuals referenced in the index. It was edited by two feminist architecture scholars and it was a result of a Society of Architectural Historians (SAH) session on Domesticity and Gender in Modern Architecture in 2003.<sup>32</sup> In this way, this is a very different book written by multiple scholars, experts in their subjects and not claiming to be a detailed overview of modern architecture history. Furthermore, the topic of gender and women architects is of special interest in this book. *Negotiating Domesticity* is the only title that contains an almost equally high ratio of male and female pronouns 167 she and her and 186 he, him and his. In this way, the women architects mentioned have their life and work described in the more detail compared to the nine other books. This book also passes the Torre test.

*Negotiating Domesticity* is the only book that mentions the British modernist architecture contributor Elizabeth Denby (1894–1965). Denby was a successful designer and expert in the subject of modern housing. She was involved in several well-known modernist projects of the 1930s.<sup>33</sup> In the chapter titled 'A citizen as well as a housewife', Denby's productions are described as a member of the Utility Furniture Advisory Committee and as a housing consultant (pp. 49–64). The British author, Elizabeth Darling, mentions Denby's collaboration with the architect Max Fry but she also presents direct quotations from Elizabeth Denby herself, thus, giving her a voice and a life as a designer outside her collaboration with a man.

## Conclusion

Four out of the ten books pass the Torre test. The books that were the most frequently available within the Belgian libraries failed. In this way, six titles out of ten did not reach the simple three-page requirement to describe the work, life or ideas of a single woman architect or designer. This test was deliberately made simple and easy to pass in order to draw attention to a great discrepancy that persists today. Forty years after Torre's book and exhibition, there is a persisting lack of acknowledgement of women's contributions to modern architecture.

Recently published works by architectural theorists and historians have responded to some of the criticisms that feminist researchers often receive. One for example is the criticism that 'there are no modern women architects in history books because there were fewer women that had access to an architectural diploma at the beginning of the twentieth century.' However, this thought is misleading. The reality is that modern architecture was never a movement that required obtaining an architecture diploma. Some of the greatest male architects that lead the movement never obtained an architecture degree and sometimes never even received education from a formal college setting. Renowned modern architects such as Adolf Loos and Le Corbusier never acquired any university diplomas,<sup>34</sup> even though they commonly engaged in teaching and in writing about modern architecture.

In the same way, there have been many women that also practiced architecture without formal credentials, for example Lady Elizabeth Wilbraham who is attributed the role of architect for leading and designing the construction at least a dozen houses for her wealthy family in the 17th century.<sup>35</sup> A Belgian historian, Julie Piront, even discovered that groups of religious women between 16th–17th century in Belgium and France often designed and supervised their own built environments.<sup>36</sup>

Furthermore, several women actually had already attended architecture studies at the very beginning of the twentieth-century in a few countries. Some of these are the previously cited, Vivi Lönn and Marion Mahony as well as Julia Morgan (1872–1957), the first woman architect to graduate from the Beaux-Arts school in Paris,<sup>37</sup> and Margaret Staal-Kropholler (1891–1966), the first woman architect in the Netherlands.<sup>38</sup>

32 Hilde Heynen and Gülsüm Baydar, *Negotiating Domesticity: Spatial Productions of Gender in Modern Architecture* (London: Routledge, 2005).

33 Elizabeth Darling, "The Star in the Profession She Invented for Herself: A Brief Biography of Elizabeth Denby, housing consultant," *Planning Perspectives* 3 (2005), 273.

34 Adolf Loos et al., *The Architecture of Adolf Loos: An Arts Council Exhibition* (London: Arts Council of Great Britain, 1985), 116; Nicholas Fox Weber, *Le Corbusier: A Life* (New York: Alfred A. Knopf, 2008), 456.

35 John Millar, "The First Woman Architect," *The Architects' Journal*, November 11, 2010, <https://www.architectsjournal.co.uk/the-first-woman-architect/8608009.article> (accessed June 16, 2017); Nicole Pohl, *Women, Space and Utopia, 1600–1800* (Farnham: Ashgate Publishing Limited), 2006, 66.

36 Julie Piront, "Empreintes architecturales de femmes sur les routes de l'Europe: Étude des couvents des annonciades célestes fondés avant 1800" (PhD diss., Université catholique de Louvain, 2013).

37 Ginger Wadsworth, *Julia Morgan: Architect of Dreams* (Minneapolis: Twenty-First Century Books, 1990), 25.

38 Dave Wendt, *Academie van Bouwkunst Amsterdam 1908–2008* (Rotterdam: Uitgeverij 010 Publishers, 2008), 19. For more examples of women architects at the beginning of the twentieth century see: Despina Stratigakos, "Architects in Skirts: The Public Image of Women Architects in Wilhelmine Germany," *Journal of Architectural Education* 2 (2001), 90–100.

Finally, some may dismiss this failure by saying that 'there are less women in the history books because it is a reflection of the reality at the time.' This conclusion could be drawn if we were to study only one book, with few women citations, for example the 2005 *Architecture in the 20th Century* by Peter Gössel and Gabriele Leuthäuser. However, if one were to pick up another book, such as the *Encyclopaedia of 20th Century Architecture* or *The A-Z of Modern Architecture* then one would see that there are at least 140 women that contributed to the history of modern architecture, and even more outside of these two books. This suggests scientific inaccuracy as historians or a conscious bias against women's contributions.

In order to shine light on the invisibility of women architects, it is essential to measure the weight of their absence in the records of modern architecture. Numerous female modern architects and designers have been researched and their work proliferated in the last decades. These female histories need to be acknowledged. Historians of modern architecture should move on from the naïve male-hero narrative. Recognizing collaboration between architects will result in a better representation of history. Historians value the story of the ingenious male hero who is admired for his unlimited imagination and building abilities. The problem with this hero story, despite its inaccuracy, is that it has become the only story of modern architecture. As literary author Ngozi Adichie stated in 2009,

The single story creates stereotypes, and the problem with stereotypes is not that they are untrue, but that they are incomplete. They make one story become the only story. (...) The consequence of the single story is this: it robs people of dignity. It makes our recognition of our equal humanity difficult. It emphasizes how we are different rather than how we are similar. Stories matter.<sup>39</sup>

<sup>39</sup> Chimamanda Ngozi Adichie, *The Danger of a Single Story*, screened July, 2009 (Oxford, TED Global, 2009), [http://www.ted.com/talks/chimamanda\\_adichie\\_the\\_danger\\_of\\_a\\_single\\_story/transcript](http://www.ted.com/talks/chimamanda_adichie_the_danger_of_a_single_story/transcript).

### Florencia Fernandez Cardoso

Katholieke Universiteit Leuven KUL / Université Libre de Bruxelles ULB



Florencia Fernandez Cardoso is an architect. She graduated in 2013 with a Master's in Architecture from the Faculty of Architecture La Cambre-Horta, at the Université Libre de Bruxelles (ULB), where she also obtained a Bachelor in Architecture (2011). At the moment she is preparing a PhD in the same faculty as a joint-degree with KU Leuven and ULB, under the supervision of Hilde Heynen (KUL) and Christine Schaut (ULB). She is a researcher at Hortence (Architectural History, Theory and Critique) and Sasha (Architecture and Social Sciences), two laboratories that are part of the research center CLARA. Florencia is a member of the editorial committee of the annual scientific journal *Clara: Architecture/Recherche*.

E-mail: [florencia.fernandez.cardoso@ulb.ac.be](mailto:florencia.fernandez.cardoso@ulb.ac.be)

## Anni Albers and Lilly Reich in Barcelona 1929: Weavings and Exhibition Spaces

The Bauhaus participated as an industry in the German section of the 1929 Barcelona International Exhibition, sending objects to the Palaces of Textile Industries and Decorative and Industrial Arts, two interiors (besides another thirteen) designed by Lilly Reich and Mies van der Rohe. The ground-breaking design for the Textile Industries exhibition space clearly contrasted with the architecture of the given neoclassical palace.

The exhibited Bauhaus objects were samples of drapery material, upholstery material, and wall-covering materials, the three types of utilitarian weavings Anni Albers elaborated at the Bauhaus weaving workshop, apart from her own artistic wall hangings. In the fall of 1929, after her visit to Barcelona, Albers would design an experimental wall-covering material for the Bundesschule Auditorium of Hannes Meyer's Federal School of the ADGB in Bernau. The original weaving had two different sides, one for acoustic absorption (made out of a straw-like synthetic material with chenille backing), the other for light reflection (of a silver finishing), which would grant Albers her Bauhaus degree in February 1930.

The goal of this paper is to set out the role played by Reich in the interior design of the exhibition spaces in Barcelona and to trace the origin of the material innovation of Albers's weavings.

Keywords: Anni Albers, Bauhaus, exhibitions, interiors, Lilly Reich, textiles

This paper examines the work of Anni Albers (1899–1994) to ascertain the impact that the visit to Barcelona International Exhibition during the summer of 1929 had on her later work. Albers was then a student of the Bauhaus weaving workshop and would graduate the following semester, in February 1930.<sup>1</sup> Lilly Reich (1885–1947) would not join the Bauhaus until 1932.<sup>2</sup> However, Reich's work in the interior designs of the vast German exhibits in Barcelona 1929 is echoed in a building that was collectively designed by the various Bauhaus workshops under the directorship of Hannes Meyer (1889–1954), and in which Albers participated, also in 1929.

Despite all that has been discussed in relation to the Barcelona International Exhibition, an important fact has remained undiscovered for scholarship in the fields of decorative arts, design history and material culture. In early 1929 the Bauhaus had already acquired many commitments to participate in several exhibitions throughout that year.<sup>3</sup> Barcelona, together with Basel, Brussels, Leningrad and Paris, was one of the many cities outside Germany, where the Bauhaus was planning to display its objects. In fact, the Bauhaus participated as an industry in the German section of the 1929 Barcelona International Exhibition, sending objects to the Palace of Textile Industries (*Textilpalast*) and to the Palace of Decorative and Industrial Arts (*Gewerbepalast*).<sup>4</sup>

1 Anni Albers's Bauhaus diploma was signed in Dessau on February 4, 1930, by the Director Hannes Meyer and the Head of the Department Gunta Sharon-Stölzl. Box 29, Folder 2, Anni Albers Papers. The Josef and Anni Albers Foundation, Bethany, CT.

2 Mies van der Rohe offered Lilly Reich a position at the Bauhaus in Dessau a few months after he became its director in September 1930. Gunta Stölzl left the weaving department in September 1931, and Lilly Reich became the director of both the weaving studio and the building/finishing department in January 1932. See Magdalena Droste, "Lilly Reich: Her Career as an Artist," in Matilda McQuaid (ed.), *Lilly Reich: Designer and Architect* (New York: The Museum of Modern Art, 1996), 55.

3 On the first issue of the *Bauhaus* journal in 1929, the Bauhaus presence was noted on two lines, lost on a list with sixteen other exhibitions in which the school was taking part during that season. See "Ausstellungen," in *Bauhaus: Zeitschrift für Gestaltung* 3, no.1 (1929), 24.

4 Firma (company), Bauhaus Dessau, Dessau, Ebertallee, 12. Palacio (palace), Artes Decorativas e Industriales y [sic] Industrias Textiles. Box 47174, Expo 1929 Inventari Objetos de Artes. Exposición. Barcelona Extranjero y Estado. Listado de expositores, 4. Arxiu Contemporani, Exposición Internacional de 1929 (1923–1942), Barcelona. See also *Internationale Ausstellung Barcelona 1929: Deutsche Abteilung* (Reichsdr., 1929), 58 and 66.

As is already well known, most of the attention of the German presence in Barcelona went to the two pavilions that were built *ex-novo*, the renowned Representative Pavilion and also the German Electrical Industries Pavilion, both designed by Ludwig Mies van der Rohe (1886–1969). However, what it is less known is that another 16,287 m<sup>2</sup> were devoted to the exhibition of German industries in the fairgrounds of Montjuïc.<sup>5</sup> Reich and Mies had been in charge of designing the German sections in parts of the interiors of eight separate neoclassical palaces: the Southern Palace on the top of the mountain; the Machine Palace (with sections for Electricity, Motive Force and Chemical Industries), the Palace of Projections, and the Palace of Communications and Transport, around the main avenue; the Palace of Textiles Industries and the Palace of Decorative and Industrial Arts to the eastern side; and the Palace of Graphic Arts and the Palace of Agriculture on the top of the ridge. These commissions were interiors, which had to be accommodated in neoclassical buildings of the most different nature.

The linguistic diversity and the varied spatial quality of these eight neoclassical palaces –and the areas devoted to the display of the 342 German industries– indicate the colossal challenge that Reich and Mies faced to accomplish this endeavour. The spatial structures of the given palaces (most of them designed by local architects) ranged from ample horizontal spaces with steel columns of great slenderness, to double-height volumes resting on Corinthian columns, as the numerous interior photographs attest. Their assorted size is also apparent when comparing the ground plans (Fig. 1).<sup>6</sup> The dark shading in the image shows how the German sections occupied spaces of very different dimensions and kinds: between 2000 and 3000 m<sup>2</sup> devoted to Electricity, Motive Force and Chemical Industries, Communications and Transport, and Textiles Industries; 1,500 m<sup>2</sup> to the different exhibits distributed in the Southern palace; around 700 m<sup>2</sup> to Graphic Arts; smaller and varied areas to Decorative and Industrial Arts, as well as to Agriculture. Additionally, the German objects on display ranged from light to heavy industries. Thus, achieving consistency by providing a neutral background (where to underscore the particularities of the objects themselves) was not a minor challenge for the architects.



Fig. 1. 1929 Barcelona International Exposition site plan with the German presence marked in the different palaces. Collage by the author.

#### Legend

##### Pavilions.

**30.** German Pavilion.

**139.** Electrical Industries Pavilion

##### Industrial Exhibits distributed in Palaces

**4.** Palace of Graphic Arts, *Buchgewerbepalast*: 680 m<sup>2</sup>

**5.** Palace of Agriculture, *Landwirtschaftspalast*: 100 + 20 + 1300 + 100 m<sup>2</sup>

**6.** Palace of Decorative and Industrial Arts, *Gewerbepalast*: 841 + 400 + 100 + 100 m<sup>2</sup>

**7.** Machine Palace (Electricity, Motive Force and Chemical Industries) *Chemie- und Maschinenpalast*: 2500 + 2117 m<sup>2</sup>

**9.** Palace of Projections, *Projektionspalast*: 529 m<sup>2</sup>

**10.** Palace of Communications and Transport, *Verkehrspalast*: 3000 m<sup>2</sup>

**11.** Palace of Textiles Industries, *Textilpalast*: 3000 m<sup>2</sup>

**46.** Southern Palace, *Konstruktionspalast*: 1500 m<sup>2</sup>

\*Numbering according to the Spanish catalog of the German section.

Published in *Exposición Internacional de Barcelona 1929: Catalogo oficial de la sección alemana* (Berlin: Reichsdruckerei, 1929).

5 The German section of the International Exhibition of Barcelona occupied a total surface of 17.562 m<sup>2</sup>, including the official Representative Pavilion and its garden, which took up 258 m<sup>2</sup> and 417 m<sup>2</sup> respectively, and the Electrical Industries Pavilion that extended over 600 m<sup>2</sup>. The exhibition in the Palace of Textile Industries and the Palace of Decorative and Industrial Arts, the two palaces where the Bauhaus was present, occupied 3.000 m<sup>2</sup> and 1.441 m<sup>2</sup> respectively. In total, 342 German exhibitors took part in the different sections of the International Exhibition. Box 47174, Expo 1929 Inventari Objectos de Artes. Exposición. Barcelona Extranjero y Estado. "Exposición Internacional de Barcelona 1929. La sección extranjera de la exposición." Arxiu Contemporani, Exposición Internacional de 1929 (1923-1942), Barcelona.

6 See the official catalogue publication *Internationale Ausstellung Barcelona 1929*: Machine Palace (Electricity, Motive Force and Chemical Industries Palace), (*Chemie-und Maschinenpalast*), 2; Projections Palace (*Projektionspalast*), 35; Palace of Communication and Transport (*Verkehrspalast*), 39; Palace of Textile Industries (*Textilpalast*), 51; Palace of Decorative and Industrial Arts (*Gewerbepalast*), 61; Palace of Agriculture (*Landwirtschaftspalast*), 71–3; Palace of Graphic Arts (*Buchgewerbepalast*), 79; Southern Palace (*Konstruktionspalast*), 87. Copy deposited at the Bauhaus-Archiv, Berlin.

There were areas, such as the ample 3,000 m<sup>2</sup> space devoted to the Palace of Communications and Transport, which Reich and Mies left almost bare, so that the German means of transportation could be openly seen underneath the vaulted hangars. Others, such as the space devoted to the now famous beer-stand from Munich, which were simply sandwiched in an U-shape created by three walls between four Corinthian columns. Reich and Mies proposed different finishings depending, not only on the spatial structure of the given neoclassical palaces, but also, on the light-or-heavy character of the industries that would be on display. One clear example is the varied way in which they responded to two predetermined and similar interiors: that of the Electricity and Motive Force Industries and that of the Chemical Industries, to the left and right sides of the Machine Palace. In the Chemical Industries section, their aim was to cover the floors with linoleum, to lower the height of the ceiling with a hanging ceiling composed by one-meter-wide textile bands, and to panel most of the vertical surfaces in white whilst in the Electricity and Motive Force section, all surfaces were left bare.

The design of vitrines, shelves, lettering and signage was not a minor issue. Reich and Mies designed an extensive range of pieces of furniture to display a varied array of industrial products: from chemical compounds and optical objects to books and graphic arts. Additionally, the two architects naturally introduced 'still-lives' composed by tubular-steel furniture such as Mies's MR10 chairs, MR20 chairs, MR1 stools, as well as MR30 tables (Fig. 2). These pieces of furniture had originally been designed in 1927 for Mies's apartments at the Werkbund exhibition *Die Wohnung* (The Dwelling) at the Weissenhofsiedlung in Stuttgart, forming a consistent group of a chair, a chair-with-armrests, an ottoman, and a small round table. Metallgewerbe Joseph Müller from Berlin was the company that commercialized all the furniture from the German interiors in Barcelona, and also provided the steel frames for the freestanding elements that supported most of the objects on display.

The fifteen interiors distributed over eight palaces show how, with a few materials and a series of carefully controlled design strategies, Reich and Mies were successful in placing the heterogeneous objects of the German industries comfortably against a uniform background. The MR chair/ chair-with-armrest/ ottoman/ table sets, and the way they had been carefully introduced, played a crucial role in procuring formal consistency to a series of spaces that were otherwise heterogeneous in character. The official catalogue included a full-page advertisement of the

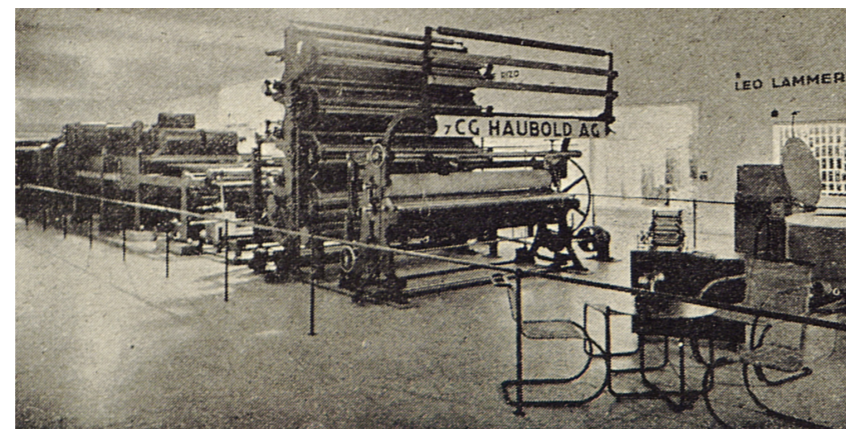

Fig. 2. Area of Textile Machinery at the Palace of Textiles Industries, with Ludwig Mies van der Rohe's furniture in the forefront. Published in *Exposición Internacional de Barcelona Diario Oficial*, no. 34, October 26, 1929, 4. Biblioteca Nacional de España.

steel-tube MR 10 chair with the seat and the back in 'Lilly Reich Weave',<sup>7</sup> since Mies took every opportunity to blatantly promote his furniture in what seemed to be a new promising market.<sup>8</sup>

The omnipresence of Mies's furniture in every single interior of Barcelona, and the quick and widespread commercialisation of it in Spain, led the Basque architects Joaquín Labayen (1900–1995) and José Manuel Aizpurúa (1902–1936) to choose the MR10 chair in wickerwork for the interior of the Nautical Club House they opened in San Sebastian in the summer of 1929, four months after the opening of the Barcelona International Exhibition, on the other side of the Franco-Spanish border. The mobility of the MR chair, its journey from Barcelona to San Sebastian, is relevant because it traces the travel itinerary that Anni and Josef Albers (1888–1976), followed from the Mediterranean to the Cantabric border of Spain that summer of 1929 (Fig. 3).<sup>9</sup> It also shows the impact of Mies's furniture in the shaping of modern interiors, since the German Pavilion in Barcelona and the Nautical Club House in San Sebastian would be precisely the only two works built on Spanish ground to be part of the *Modern Architecture: International Exhibition* at the MoMA in 1932.<sup>10</sup>

As explained, the fact that the Bauhaus had sent objects to two of the Barcelona exhibits, the Palace of Textile Industries and the Palace of Decorative and Industrial Arts, was the main motivation for the Alberses to decide to embark on a Southern European journey, since some of the fabrics woven by the Bauhaus weaving workshop (probably even by Anni Albers) were displayed in the German section of the Textile Industries.

The Palace was a neoclassical building finished by local architects Joan Roig and Emili Canosa in 1928. The area occupied by the German section extended through the front axis, and occupied an area equivalent to the space underneath the main dome. Austria, France, Italy, Spain, and Switzerland inhabited this space as well as the two other square areas on either side of it, and an extension to the northern side of the interior aisle. The plan for each of these squares was

7 This is the name that was given to the version of the chair in wickerwork, since it was long thought that Mies's tubular Steel models MR10 and MR20 had been 'revised in 1927 by his employee, Lilly Reich.' However, this is a fact that has been refuted in ZI Research Group, "The 'Lilly Reich Weave,'" in Helmut Reuter and Birgit Schulte (eds.), *Mies and Modern Living: Interiors, Furniture, Photography* (Ostfildern: Hatje Cantz, 2008), 139.

8 The full-page advertisement included in the official catalogue reads: 'The MR chair is elastic and follows the movements of the body. It is made out of steel tubes and it is delivered in chrome, nickel or lacquered in color, and the seat and the back come in leather or wickerwork. Better quality, bigger solidity' (translation by the author). Mies registered the patent of the MR10 chair for its 'improvement in chairs and curved armchairs' a few days after the opening of the Barcelona International Exhibition in 15 June 1929. On Mies's business with patent registrations of his chairs see Pablo López Martín, "La silla de la discordia. La pequeña escala como campo de experimentación de la modernidad. Breuer, Mies y Stam" (PhD diss., Universidad Politécnica de Madrid, January 2016).

9 See Laura Martínez de Guereñu, "Bauhäuslers on the Franco-Spanish Border," *Architectural Histories*, 4, no. 1 (2016), 15, DOI: <http://doi.org/10.5334/ah.191> (Special issue: Travel).

10 Mies's German Pavilion at the Barcelona Exposition (187–8), Labayen & Aizpurua's Nautical Clubhouse in Donostia-San Sebastián (174), in Henry-Russell Hitchcock Jr. and Philip Johnson, *The International Style: Architecture since 1922* (New York: W. W Norton & Company, 1932).

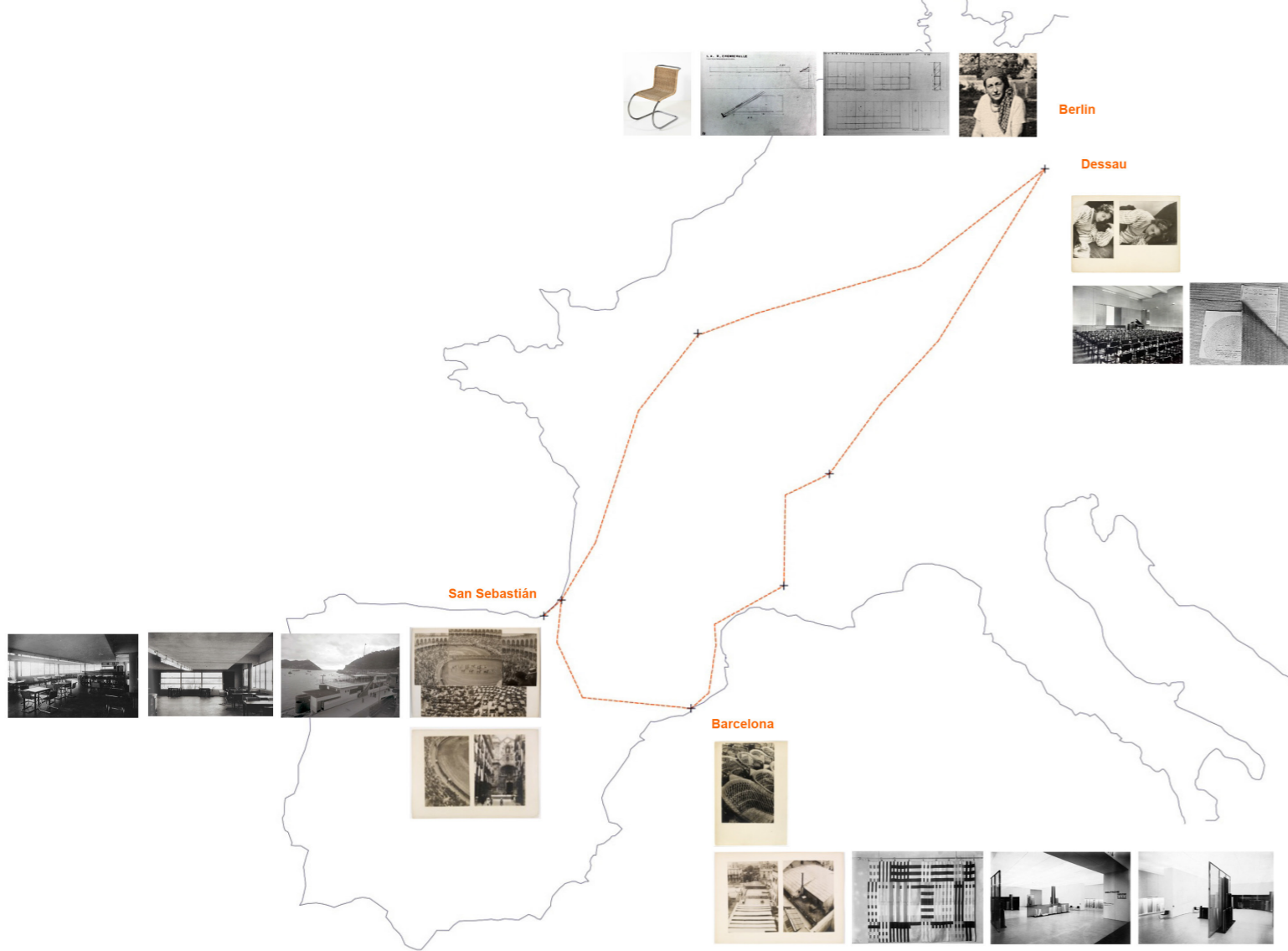

Fig. 3. Itinerary of Anni and Josef Albers during the summer of 1929, with designs and pieces of furniture of members of the Bauhaus. Mapping by the author.

**Legend**

Berlin:

Portrait of Lilly Reich; Plans of the interiors of Barcelona Exhibits; Ludwig Mies van der Rohe's MR10 chair in wicker.

Dessau:

Photocollage of Anni Albers by Josef Albers; Interior view of the auditorium of the ADGB building; Wall covering material for the auditorium.

Barcelona:

Photocollages by Josef Albers; Textile design by Anni Albers; Interior views of Deutsche Seide at the Palace of Textiles Industries.

San Sebastián:

Photocollages by Josef Albers; Exterior and Interior views of the Nautical Club by Joaquín Labayen and José Manuel Aizpurúa.

organised according to a classical compositional spatial structure. Four main columns created a central square accompanied by eight other smaller columns, placed toward their two perpendicular sides in each area; all of them together supported friezes that crossed and marked the height of the ceiling perpendicularly.

Reich and Mies created a ground-breaking design for this exhibition space, which clearly contrasted the architecture of the designated neoclassical palace as well as the interior design of the rest of the represented countries in the same building. It is worth comparing the original distribution of the stands anticipated by the general committee of the Barcelona exhibition, with the way Reich and Mies organised the German products.<sup>11</sup> In the original Palace of Textile Industries, a steel structure was covered with plaster creating concentric friezes at a low height and the stands were rationally organised following these concentric areas. Reich and Mies broke the alignments of the distribution of the stands, allowing the visitors to move freely across the space. In order to do so, they covered the perimeter walls with modular white panelling and created four cabinets in the form of an L (facing each other towards the central space) thereby distinguishing a perimeter circulation from a central space (Fig. 4).

In the central area, the weavings were hung from freestanding bars of different width and height that advanced over an array of isolated coloured glazed walls of chrome carpentries. These coloured-glass walls, including a curved one, divided the space, while allowing a view through it. The cabinets in the form of an L, as well as the perimeter walls, served as backdrops for the freestanding coloured glass walls and the textiles hanging from them. Thus, the modular repetition of the white wood panes in the background, the four L-shaped cabinets, and the freestanding glazed walls created a balanced atmosphere in which the objects on display were foregrounded (Fig. 5). The images of this interior space show some of the many details of the panelling that were designed in order to create a distinct interior to the one originally offered in the form of a neoclassical palace. The photographs also reveal how assorted the areas of the section were, accommodating miscellaneous products and machines.

As the official catalogue of the German presence in Barcelona reveals, the Bauhaus was exhibited in one of the displays of the perimeter spaces on the left side of Deutsche Seide, amongst thirty-eight other German industries distributed in the entire area, including companies such as Gütermann that still survive today.<sup>12</sup> As the listing reads, the objects that the Bauhaus sent to this section were

<sup>11</sup> The original plans with the exhibitor-distribution of the different palaces that are stored as part of the holdings of the Arxiu Contemporani in Barcelona [Exposició Internacional de 1929 (1923–1942)] differ substantially from the plans designed by Reich and Mies, as the plans of the Mies van der Rohe Archive and the numerous photographs of the exhibition display attest.

<sup>12</sup> The list of objects in the section devoted to the Palace of Textile Industries (*Textilpalast*) that also shows a distribution plan in one of the publications about the German presence in Barcelona reads: '15. Bauhaus Dessau, Dessau: Vorhangstoff, Diwanddeckenstoff, Spannstoff.' See *Internationale Ausstellung Barcelona 1929*, 58.

Fig. 4. Plan of the Palace of Textiles Industries, with reference to the different German exhibitors.

#### Legend

1. Berlin-Karlsruher Industrie-Werke Aktien-Gesellschaft, Karlsruhe (Baden)
2. Mundlos Aktien-Gesellschaft, Nähmaschinen-Fabrik, Magdeburg-Neustadt
3. G. F. Grosser, Fabrik für Flachstrick-maschinen, Rundstrickmaschinen, Spulmaschinen, Markersdorf (Chemnitztal)
4. Louis Bahner, Strumpfwirkerei, Oberlungwitz (Sachsen)
5. Gütermann & Co., Nähseidenfabrik, Gutach (Breisgau)
6. Limbacher Maschinenfabrik Bach & Winter, Limbach (Sachsen)
- Biernatzki & Co., Chemnitz
- Emil Wirth, Wirkmaschinenfabrik, Hartmannsdorf bei Chemnitz
- Seyfert & Donner, Chemnitz
- Dürkoppwerke A.-G., Nähmaschinenwerk, Bielefeld
- G. Hilscher, Wirkmaschinenfabrik, Chemnitz
- C. A. Roscher Söhne, Rundwirk – und rund-Strickmaschinenfabrik, Mittweida (Sachsen)
- Chemnitzer Strickmaschinenfabrik A. –G, Chemnitz
7. C. G. Haubold A. –G, Maschinenfabrik, Chemnitz
8. Leo Lammertz, Nadelfabrik, Aachen (Rheinland)
9. S. Fränkel, Tischzeug-, Leinwand . und Frottierwarenfabrik, Neustadt (Ober-Schlesien)
10. Wilhem Geidner, Metallwarenfabrik, Kempten (Bayern)
11. Mauser-Werke A. ´G., Werk Spezialnäh-Maschinenbau, Oberndorf am Neckar (Württemberg)
12. Elite-Diamantwerke Aktiengesellschaft, Siegmars-Chemnitz
13. Erich Barth, Chemnitz
14. Deutsche Seide
  - a. Verein Deutscher Seidenwebereien, Krefeld
  - b. Verband Deutscher Samt – und Plüschfabriken, Krefeld
  - c. Vereinigte Glanzstoff-Fabriken A.-G., Elberfeld
  - d. I. P. Bemberg A. –G, Barmen-Ritters-Hausen
  - e. I. G. Farbenindustrie A. –G., Abteilung Kunstseide, „Agfa“ Berlin so 36.
- 15a. Handweberei Hablik-Lindemann, Itzehoe (Holstein)
- 15b. Bauhaus Dessau, Dessau
- 15c. Deutsche Textile Kunst Deteku, Rudolf Hiemann, Leipzig

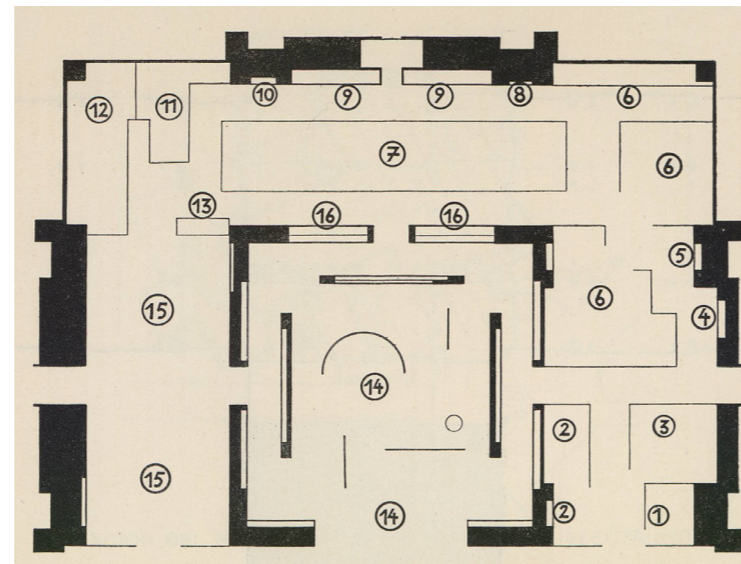

- 15d.u.f. Mechanische Weberei Pausa A., -G, Stuttgart
- 15e.u.k. Deutsche Werkstätten Textilgesellschaft M. B. H. Dresden –A.
- 15g. Staatliche Hochschule für Handwerk und Baukunst, Weimar
- 15h. Spitzenwerkstätte, Elfriede Freiin von Hügel, Stuttgart.
- 15h. Forkelsche Arbeitsgemeinschaft, Plauen (Vogtl.)
- 15h. Staatliche Kunstschule für Textilindustrie, Plauen (Vogtl.)
- 15h. Spitzenkunst L. Matthaei, Hannover, Ferdinandstrasse 41
- 15h. Frau Margret Klaiber-Gminder, Öhringen (Württemberg)
- 15i. Staatliche Spitzenklöppelschule Tiefenbach, Tiefenbach (Oberpfalz, Bayern)
- 15i. Staatliche Spitzenklöppelschule Stadlern, Stadlern (Bayern)
- 15i. Staatliche Spitzenklöppelschule Schönsee, Schönsee (Bayern)
- 15i. Staatliche Klöppelschule Nordhalben, Nordhalben (Bayern)
- 15i. Staatliche Klöppelschule Abenberg, Abenberg (Bayern)
16. Nieuhuus & Dütting, Baumwollspinnerei, Weberei, Färberei, Bleicherei, Nordhorn (Hannover)

Published in *Exposición Internacional de Barcelona 1929: Catalogo oficial de la sección alemana* (Berlin: Reichsdruckerei, 1929), 50–57.



Fig. 5. Lilly Reich and Mies van der Rohe, Interior view of the Palace of Textile Industries. Courtesy of the Bauhaus-Archiv, Berlin.

samples of drapery material, upholstery material, and wall-covering material, the three types of utilitarian and anonymous weavings Anni Albers designed, together with her own artistic wall hangings, at the Bauhaus weaving workshop. However, there are no photographs that can show how the

space on this side of the perimeter gallery had been distributed. Instead, there are two photographs showing sewing machines by Mauser-Werke A. G., knitting machines from Elite-Diamantwerke, and every kind of textile machine from C. G. Haubold A. G., in the continuing perimeter of the gallery. The longitudinal arrangement of this machinery recalls another project that Reich had designed on her own three years earlier for the International Frankfurt Fair: 'Von der Faser zum Gewebe' (*From Fiber to Textile*). In this design Reich had foregrounded the display of the industrial process of production, showing the manufactured raw materials and distinguishing between phases and types in an almost scientific way.<sup>13</sup> This precedent clearly reveals Reich's responsibility in the overall design of the interior at the Palace of Textile Industries of Barcelona, something that Mies never obscured.<sup>14</sup>

<sup>13</sup> See Matilda McQuaid, "Lilly Reich and the Art of Exhibition Design," in McQuaid, *Lilly Reich*, 21.

<sup>14</sup> In the introductory note to *Barcelona Exhibits 1929* published in *The Mies van der Rohe Archive* by Garland, Franz Schulze only recognizes that 'the special talents of his companion, the designer Lilly Reich, proved of inestimable value' when Mies was called upon to oversee the layout and the design of the individual exhibits of Barcelona. See Arthur Drexler (ed.), *The Mies van der Rohe Archive*, Vol. 2 (New York: Garland Publishing Co., 1986), 246. Valentín Trillo explains also how Mies named Reich co-author of the entire Barcelona exhibits project in the letter he sent to commissioner Von Schnitzler on 28 September 1929, in which he justified a summary of the budget of the German participation in Barcelona. Bundesarchiv, Politisches archive, MAEB R240030/ 0107-0138. Berlin, October 7, 1929. Quoted in Valentín Trillo, "Mies in Barcelona: Arquitectura, representación y memoria" (PhD diss., Universidad de Sevilla, January 2016), 289. Additionally, correspondence between the office of Internationale Ausstellung Barcelona 1929, Der Deutsche Generalkommissar in Barcelona and Lilly Reich in Berlin, from 26 November 1929, discussing the days of work devoted to the installation of different industries on display at the Textile Pavilion (2 days for Nieuhuus & Dütting; 4 days for Bauhaus, Pausa, etc; 2 days for Spitzen; 2 hours for Güttermann and 23 days for Deutsche Seide) can be found at the Mies van der Rohe Archive, the Museum of Modern Art, New York.



Fig. 6. Anni Albers, *Wall Hanging*, 1926, Woven, Silk (three-ply weave); actual: 178.8 x 117.8 cm (70 3/8 x 46 3/8 in.).

Courtesy of Harvard Art Museums/Busch-Reisinger Museum, Association Fund, BR48.132

© The Josef and Anni Albers Foundation / Artists Rights Society (ARS), New York

(Photo: Imaging Department © President and Fellows of Harvard College).

However, there is no evidence of which specific weaving samples the Bauhaus sent to Barcelona, nor whether some of them were made by Albers herself or not. The interior of the Palace of Textile Industries was clearly the most successful one of the entire fair, for it showed the high quality and modern taste of the German textile industries.<sup>15</sup> It has also been discovered that Anni was always the one in charge of 'engineering' the trips and arranging the itineraries that she and Josef would follow, which leads one to think that it was her idea to embark on a Southern trip, from Dessau to Barcelona, in the summer of 1929.<sup>16</sup>

During the 1920s, Anni Albers's artistic work developed on a parallel track to that of Josef Albers. Anni's weavings and Josef's glass paintings show an interest in exploring the same architectural themes. It is easy to find striking correspondences, as is the case with some of her weavings such as *Pictorial Tapestry* (1925), and his glass paintings such as *Skyscrapers on Transparent Yellow* (1929); or with *Wall Hanging in Silk* (1926) (Fig. 6) and *Interlocked* (1927) (Fig. 7). Although the architectural implications of Josef's glass paintings might be more apparent (due to the way they represented overlapping of horizontal floors or the play between regular supports and cantilevers), the exchange –and the mutual influence– of their work is obvious. Looking at the dates, it can be inferred, however, that it was Anni who influenced Josef on his tectonic explorations during the 1920s. Besides this, Anni had recognised the impact that Tuscan architecture,

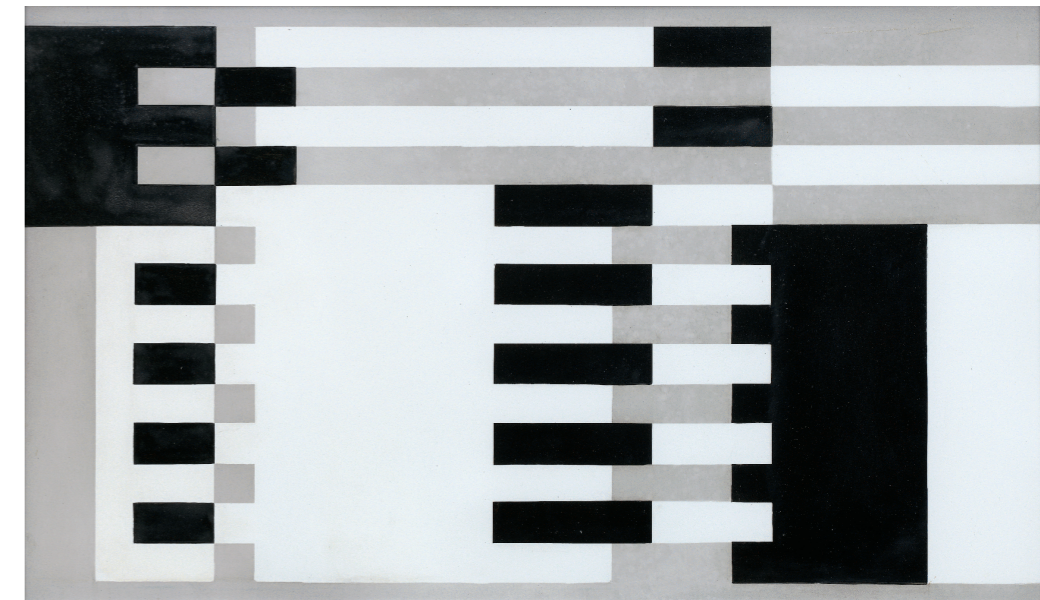

Fig. 7. Josef Albers, *Interlocked*, 1927, Sandblasted opaque flashed glass. 32,7 x 52,2 cm, Solomon R. Guggenheim, New York. Gift, The Josef and Anni Albers Foundation, Bethany, 1991.

especially the strip patterning –the alternating bands of stone of the Basilica of the Santa Croce and the Duomo Cathedral in Florence– had had on their work in 1925.<sup>17</sup> And for this reason it is not difficult to think that the Mediterranean architecture the Alberses saw in Barcelona had a similar impact on their work. If one looks at *Komposition*, the wall hanging Anni developed in 1929/1930, after their trip to Barcelona, in parallel to *Pergola*, Josef's last glass painting in his idiosyncratic 'thermometer style',<sup>18</sup> also created after the same trip, it is clear that they were both exploring and translating the same tectonic concerns. Their resemblance with the horizontal pergolas Josef captured in the interior courtyard of the Hotel Colón in which they stayed is quite astonishing. One of the images of the photo collage created by Josef Albers years later shows that some of the commercial extensions of the ground level were protected by subsequent bands of long horizontal pergolas for shadow production, very present in Mediterranean architecture.<sup>19</sup>

But this is not what interests us most about the impact the trip to Barcelona may have had on Anni's work. Anni would graduate the following February, weaving a complex textile as her final project,

17 See Nicholas Fox Weber, *The Bauhaus Group: Six Masters of Modernism* (New York: Alfred A. Knopf, 2009), 370.

18 The 'stripping' strategy that acquired the name of 'thermometer style' consisted in the employment of single pieces of opaque glass with surfaces of different colours. Josef Albers sewed bands in groups of different widths and visual weights with a variety of vertical columns, producing an effect of spatial superposition that created the illusion of transparency. Albers developed this technique to be able to create a multifaceted spatiality in single pieces of opaque glass, since for him, 'combination [became] as important as composition' in the design of his glass paintings. See "On My Glass Wall Paintings" (1933). In *Josef Albers: An Anthology (1924–1978)* (Commentaries on texts by and on Josef Albers by Laura Martínez de Guereñu), in *Josef Albers: Minimal Means, Maximum Effect* (Madrid: Fundación Juan March, 2014), 217, Exhibition catalogue.

19 The resemblance between Josef Albers's, *Studie für die Glasskonstruktion Pergola*, December 1929, and Anni Albers's *Komposition*, tapestry, 1929/1930, both at the Stiftung Bauhaus Dessau, point to one of the three images that Josef Albers took in Barcelona: *Barcelona from the Hotel Colón '29*, 1929. Gelatin silver print, mounted on cardboard, photocollage, 29,5 x 41 cm. The Josef and Anni Albers Foundation, Bethany (1976. 7.11).

15 "Una visita a la sección alemana de la Exposición de Barcelona," in *Exposición Internacional de Barcelona. Diario Oficial*, no. 12, June 2, 1929.

16 Anni Albers recognized this role she had two years earlier, with the previous trip they had made to Spain, that time on a Banana boat, to the Canary Islands. 'I was always the adventurous one who arranged tickets and visas and I had the idea that we should do (sic) a journey: we went on a banana boat to Tenerife [1927]. The whole trip there and back took five weeks. We travelled on mule back up to the pick. There were two other islands still that we visited. All was really quite adventurous.' Conversation between Anni Albers and Nicholas Fox Weber in Orange, Connecticut. October 21, 1974. Tape 2 (side A), 6:58 min; 'I was always the one who thought of [travel] when we were still at the Bauhaus.' See Maximilian Schell, interview with Anni Albers, Orange, Connecticut, December 16, 1989. Box 21, Folder 6, The Anni Albers Papers. The Josef and Anni Albers Foundation, Bethany, CT.

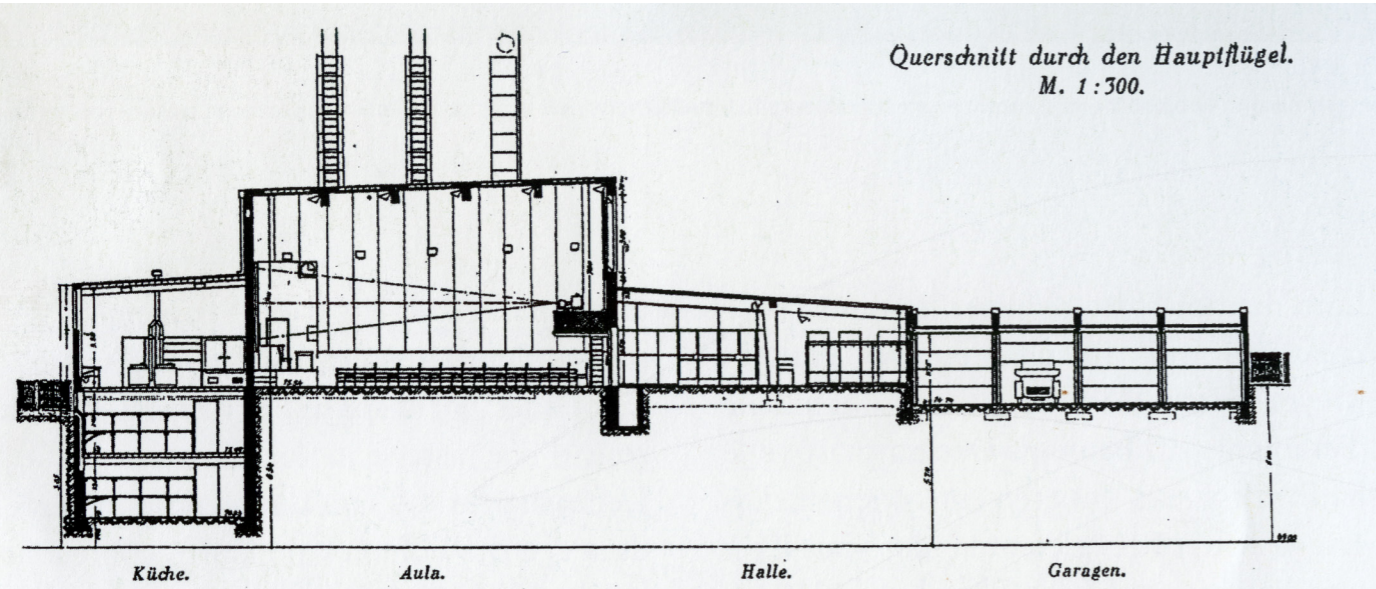

Fig. 8. Hannes Meyer, Section of the auditorium of the ADGB building, Bernau, Germany, 1929. Published in *Sonderdruck aus dem Zentralblatt der Bauverwaltung* 51, no. 14 (1931), 215.

which would solve an acoustic problem in a collective building. It was a wall-covering material for the Bundesschule Auditorium of the Federal School of the ADGB (*Allgemeiner Deutscher Gewerkschaftsbund*) in Bernau, which Meyer, then the director of the Bauhaus, was finishing in collaboration with the Bauhaus workshops.<sup>20</sup> The building had been under construction since 1928. Years later, Anni Albers herself explained how Meyer was building a union school and had come up against an echo problem in the auditorium. Meyer asked Albers specifically whether she could take care of that problem.<sup>21</sup> The section of the auditorium shows the extensive surface where Albers would need to intervene (Fig. 8).

The conventional thing to do at that time was to put velvet on the walls, because the fibers absorbed sound. But it would have to be in a dark colour, because the room was going to be used by hundreds of people, and the marks of fingerprints had to be avoided. Albers then decided to experiment with a then new synthetic material from Italy, a kind of cellophane.<sup>22</sup> Albers explained that the greatest shift took place at the Bauhaus when, in her own words, 'the idea of a practical purpose, a purpose

20 As a 'communal effort of craftsmen and inventors,' this construction materializes the words of "building," the famous thesis that Hannes Meyer published in *Bauhaus* 2, no. 4 (1928). Republished in Ulrich Conrads, *Program and Manifestoes on 20<sup>th</sup>-century Architecture* (Cambridge, Mass., The MIT Press 1970), 117–20.

21 Neil Welliver, "A Conversation with Anni Albers," in *Craft Horizons* 25, no. 4 (July - August 1965), 42.

22 'Cellophane just was coming in as a new material – we have been in Florence, Italy, and I had bought a little crocheted cap made of this material. And I unraveled it and used it for the first attempt.' In Savim Fesci, "Interview with Anni Albers, Orange, Connecticut, July 5, 1968," Archives of American Art, New York, <http://www.aaa.si.edu/collections/interviews/oral-history-interview-anni-albers-12134> (accessed July 4, 2017).

aside from the purely artistic one' brought about a profoundly different conception of her work.<sup>23</sup>

Following this idea, what Albers created was an interesting 'construction' with multiple threads: cellophane on the front (for light reflection) and white velvet on the back (for sound absorption) (Fig. 9). With this light-reflecting straw-like material on the surface, the walls could be white, because they could be cleaned by brushing. Later on, Zeiss Icon Works in Germany analysed of how the light-reflecting surface worked when the light fell on it at different angles. By this means, she demonstrated that scientific penetration was possible for textile knowledge, following the demands of the Bauhaus at that time.

Anni stated that textiles for interior use could be regarded as architectural and that, when they were not pliable, they had to compete against other materials.<sup>24</sup> This is precisely what she did with the textile of Bernau, weaving it with two opposed sides and producing an architectural element that was light-reflecting, sound-absorbent, and easily cleanable (Fig. 10). However, what made this textile architectural was probably the fact that Meyer proposed the project to her as 'a problem to solve.'<sup>25</sup>

Anni was able to understand it as such for the interior design projects she had recently seen in Spain. There, at the Palace of Textile Industries of the Barcelona International Exhibition, Reich and Mies, had also treated textiles as architectural elements, putting them at play with the white paneling and the freestanding glass walls. Such an innovative design is unlikely to have gone unnoticed by Anni



Fig. 9. Anni Albers, View of the cellophane and the velvet sides, wall-covering material for the auditorium of the ADGB building, Bernau, Germany, 1929. Courtesy of the Bauhaus-Archiv.

23 Anni Albers, "Weaving at the Bauhaus" (September 1938, revised July 1959), in *Anni Albers: Selected Writings on Design* (Middletown, CT: Wesleyan University Press, 2000), 4.

24 'It is really interesting to concentrate like an architect has to concentrate on the functioning of a house, so I enjoyed concentrating on what that specific material demanded. I developed a series of wall covering materials, which at the time I did it was non-existent really. And I tried to make them so that they were partly even light reflecting, that they could be brushed off, that they could be fixed straight and easily on the wall without pulling into different shapes, you know. So a specific task sets you a very interesting way of dealing with your choice of material, with your technique, and so on.' In Fesci, Interview with Anni Albers, Orange, Connecticut, July 5, 1968.

25 '[Hannes Meyer] was building a union school and had come up against an echo problem in the auditorium...He asked me if I could think of something to take care of this problem...This material was used in this hall effectively.' In Welliver, "A Conversation with Anni Albers," 42. Meyer disregarded the artistic dimension of architecture. As the first sentence of his text "building" reads, 'all things in this world [were] a product of the formula: (function times economy)'. See Meyer, "building," 117.



Fig. 10. View of the auditorium room of the ADGB building, covered with Anni Albers's textile. Courtesy of the Bauhaus-Archiv.

Albers, and probably more than one story could be told about the impact that the many interiors Lilly Reich and Mies designed for Barcelona 1929 have since had on architectural culture.

### Acknowledgements

This article is part of the project Bauhaus, Spain, America: Exchanges and Cultural Transfers (1928–1975) that I developed as a fellowship recipient from the edition of the BBVA Foundation Leonardo Grants for Researchers and Cultural Creators. I am also grateful to the Josef and Anni Albers Foundation, the Ludwig Mies van der Rohe & Lilly Reich Archive at the Museum of Modern Art (MoMA), New York, the Arxiu Contemporani in Barcelona and the Bauhaus-Archiv in Berlin for facilitating my access to primary sources.

### Laura Martínez de Guereñu

IE School of Architecture and Design, IE University, Madrid-Segovia



Assistant Professor at IE University, she holds a Master in Design Studies (History and Theory of Architecture) from Harvard University (2004 With Distinction) and a PhD in Architecture and a Professional Degree from University of Navarra (2006, 1998 Thesis Award of Excellence). She studies the cultural transfers and creative exchanges between the north and the south of Europe as well as North America during Modernism. Her research has been supported by the BBVA Foundation, the Fritz Thyssen Stiftung, the Josef and Anni Albers Foundation and Fundación Rafael del Pino, amongst other institutions.

E-mail: lguerenu@faculty.ie.edu; lmg@post.harvard.edu

## Women behind Swedish Grace: Success and Neglect

The Swedish national museum of art and design, the Nationalmuseum in Stockholm, has launched a project to research and collect works by women designers in the inter-war period. So far, the project has resulted in a catalogue and an exhibition of more than 140 objects by 22 women designers, most of which have been acquired in the past few years. Under the mottos of 'more beautiful wares for everyday use' and 'artists for industry', many women designers were hired by Swedish decorative arts companies in the 1920s. Known as Swedish Grace, Swedish decorative arts and design won acclaim at the 1925 Exposition des arts décoratifs et industriels modernes in Paris. Anna Petrus and Marie-Louise Idestam-Blomberg were awarded gold medals for their work but in spite of this, their names were omitted in the catalogues. Another example is Sylvia Stave, who had a design career in modern materials until she married and was forgotten. When the Italian firm Alessi resumed production of one of her shakers, they thought Marianne Brandt had designed it. Although successful during their time, women designers in the Swedish inter-war period were ignored and forgotten due to their family situation, gender-biased company relations, and not least institutional neglect by the Nationalmuseum.

Keywords: Sweden, historiography, museum (re)presentation, women designers

### Introduction

When the Swedish luxury liner M/S Kungsholm had crossed the Atlantic Ocean and arrived in New York on 3 December 1928, everyone gasped in admiration. The newspapers reported that even the French could not have done it better. There were glamorous salons in red and black, furniture made of exotic woods with silver inlay, and magnificent staircases that could have featured in F. Scott Fitzgerald's novel of 1925 *The Great Gatsby* (Fig. 1). Every detail, from the champagne glasses to the textiles, furniture and the interiors as a whole, had been created by the most prominent designers of the time. Sweden was experiencing a heyday in decorative arts and design, and M/S Kungsholm was a floating showcase for the decorative arts industries.<sup>1</sup>

The reputation had spread since the success of the Swedish pavilion at the 1925 Paris Exposition, British critic, Morton Shand eventually coined the term Swedish Grace to describe the often classical design of glass, ceramics, furniture, and other decorative arts.<sup>2</sup> Two years later, The Metropolitan Museum of Art in New York gave Sweden the opportunity to exhibit its finest decorative arts and design. Needless to say, expectations were high when M/S Kungsholm arrived in New York.



Fig. 1. The first-class smoking room on M/S Kungsholm with cast iron reliefs by Anna Petrus on the fireplace. Courtesy of Sjöfartsmuseet Akvariet, Göteborg.

- 1 Anne-Marie Ericson, *M/S Kungsholms inredning: Mästerverk i svensk art deco* (Lund: Bokförlaget Signum, 2005); Marie Rehnberg, *Anna Petrus: Skulptör och industrikonstnär* (Stockholm: Bokförlaget Signum, 2009), 139–147.
- 2 Morton Shand, "The Stockholm exhibition," *Architectural Review* 68 (August 1930), 73–83, referred to in Anne-Marie Ericsson, *Svenskt 1920-tal: Konsthantverk och konstindustri* (Lund: Bokförlaget Signum, 1984), 8.



Fig. 2. Anna Petrus (1886–1949).



Fig. 3. Anna Petrus, Relief 'The Earth' 1928, copper, produced by Ragnar Myrsmeden. Purchase by Barbro Osher Pro Suecia Foundation, Nationalmuseum, NMK 64/2013.

Anna Petrus (1886–1949), one of the designers featured in the Nationalmuseum's acquisition and exhibition project *Women Pioneers*, had designed the large copper reliefs that were intended for the first class library on the ocean liner (Fig. 2). These were striking compositions on the four elements, inspired by Greek mythology and daringly depicting Earth as a female centaur with a small child on her shoulder (Fig. 3). At the time, this was considered an astonishing accomplishment for a woman. With her strong hands, Anna Petrus processed even the hardest materials such as stone and iron. She was the first woman in Sweden to work with cast iron and had a breakthrough at the 1925 Paris Exposition, where she was awarded a gold medal.<sup>3</sup>

But the war arrived, and when the American soldiers took over M/S Kungsholm in 1941 all the interiors disappeared. Luckily, Anna Petrus' reliefs of the four elements had yet to be mounted, which is why they are still preserved and could recently be acquired by the Nationalmuseum and shown in the exhibition at Läckö Castle and Kulturhuset Stadsteatern in Stockholm 2015.

### War, Taste, Marriage, and Dominant Companies – Four Reasons for Neglect

The exhibition, *Women Pioneers – Swedish design of the interwar period*, features more than 140 objects of glass, metal, and ceramics. Textiles are not included in the project, due to practical reasons of exhibition display but also because it is a part of the collection where women are well-represented. Most of the exhibition's 22 women artists and designers, although forgotten today – it was even difficult to find photographic portraits of some of them, which is quite striking – were prominent in the inter-war period. They participated in exhibitions in Paris, London, New York, and many other cities, they attended the Technical School, now called *Konstfack*, the University College of Arts, Crafts, and Design in Stockholm, or the Royal Academy of Fine Arts, and several of them went to Paris to study with well-known artists and sculptors. For many reasons, however, these women were later forgotten or neglected.<sup>4</sup>

One reason was, of course, the Second World War, which for years closed Sweden's doors to the outside world. At the 1939 New York World's Fair, Sweden had one of the most noticed pavilions, but the possibilities for further contacts and sales were barred when the war broke out. Then, after the war, a new generation took over.

Another reason for the neglect was the question of taste, and in this case, the Nationalmuseum is somewhat responsible. For a long time, the Museum saw itself as a guardian of good taste, and the notions of good taste meant that the more colourful and exuberant objects designed by these women in the 1920s and 30s did not fit the prevailing acquisitions policy of the Museum. Instead, the Museum favoured the more terse modernist style. Values change with time, however, and since 2012 the Museum has been actively collecting objects by women designers in the inter-war period. Unfortunately, many interesting pieces from this period had already been taken out of Sweden by the 1980s, as there was greater interest and knowledge abroad.<sup>5</sup> Since 2012, the Museum has acquired 92 objects by women designers that are featured in the exhibition.

A third reason for oblivion is the dominance of companies. When Anna Petrus designed flower pots with the same decoration she had used for the columns in the Swedish pavilion at the 1925 Paris Exposition, she was not even allowed to have her name in the product catalogue of Näfveqvarn, the foundry she worked for, even though the names of her male colleagues were listed.<sup>6</sup>

In other cases, the company name may indeed be the reason why artists and designers were forgotten. The interior design shop, Svenskt Tenn from 1924, literally Swedish pewter, is one example.

3 Sonja Lyttkens, "Min mor Anna Petrus," in *Anna Petrus: Konstnär och formgivare* (Uppsala: Sonja Lyttkens in collaboration with Bror Hjorths Hus, 2005), 21; Rehnberg, *Anna Petrus: Skulptör och industrikonstnär*, 159.

4 Magnus Olausson and Eva-Lena Karlsson (eds.), *Kvinnliga pionjärer: Svensk form under mellankrigstiden* (Stockholm: Nationalmuseum, 2015).

5 Magnus Olausson, "Inledning," in Olausson and Karlsson, *Kvinnliga pionjärer*, 4.

6 Marie Rehnberg, "Anna Petrus och Paris 1925," in *Anna Petrus: Konstnär och formgivare* (Uppsala: Sonja Lyttkens in collaboration with Bror Hjorths Hus, 2005), 35, 38.



Fig. 4. Estrid Ericson (1894–1981).  
Courtesy of Svenskt Tenn archive  
(Photo Erik Holmén).

The founder, Estrid Ericson (1894–1981), made sure the company name took pride of place, rather than the individual designers she hired, and she knew well which products were sellable (Fig. 4). 'All models are the property of the company', Ericson wrote in the product catalogue from 1931, in which she presented some of the 300 models in her assortment. In the late 1920s, she started collaborating with Anna Petrus, who, amongst other things designed a lion that Ericson used and re-used in various ways (Figs. 5 and 6). The objects are representative of the material culture of the 1920s and include tobacco jars, matchstick holders, boxes with lid, trays, mirrors, book-ends, etc. Even in the 1970s, Ericson composed a plate on which she used a cast of a lion that Petrus had designed in the 1920s.<sup>7</sup> Ericson was a business woman with an eye for what would be commercially viable, but this method of adjusting somebody else's design was only possible in a time with a different view on copyright and the designer's

influence on the final product. The brand was unequivocally the firm Svenskt Tenn and the name Anna Petrus was consequently forgotten. It is only during the past ten years that she has been recognised as one of the most original and influential designers of the inter-war period.<sup>8</sup>

Estrid Ericson had founded her company, Svenskt Tenn, in 1924, focusing on pewter as a cheaper alternative to silver. In this way, she contributed to regenerating the status of pewter as a modern material. Similarly, the decorative arts industries highlighted other materials as modern and affordable to a wide audience. The Museum's acquisitions of objects by women designers includes some pieces in German silver, which also was cheaper and more modern than real silver; earthenware, which was simpler than porcelain; and cast iron, which had mainly been used for stoves and fireplaces but was now popular for flower pots and other household items. Perhaps the most exciting material was the Swedish version of Bakelite, *isolit* from Skånska Ättiksfabriken, later called Perstorp. Wilhelmina Wendt (1896–1988) was the daughter of the factory founder and owner. She was also the first woman master silversmith in Sweden, a combination that gave her the idea to work in silver and the new plastic material (Fig. 7). She graduated from *Högre konstindustriella skolan* at *Tekniska skolan* in Stockholm in 1929 and was inspired by the Art Déco era. In 1946, she opened her own studio and production back home in Perstorp.<sup>9</sup>

7 Rehnberg, *Anna Petrus: Skulptör och industrikonstnär*, 101–103.

8 Christian Björk, "Estrid Ericson och Anna Petrus," in Olausson and Karlsson, *Kvinnliga pionjärer*, 42–44.

9 Anders Bengtsson, "Wilhelmina Wendt," in Olausson and Karlsson, *Kvinnliga pionjärer*, 30–36.



Fig. 5. Anna Petrus, Sculpture 'Lion' 1926, pewter, Svenskt Tenn.  
Purchase by The Barbro Osher Pro Suecia Foundation, Nationalmuseum, NMK 67/2014.



Fig. 6. Estrid Ericson and Anna Petrus (décor), Bowl 1944, pewter, Svenskt Tenn.  
Purchase by The Barbro Osher Pro Suecia Foundation, Nationalmuseum, NMK 66/2015.



Fig. 7. Wilhelmina Wendt, Brush 1935, silver, black isolite (plastic), Skånska Ättiksfabriken, later Perstorp AB. Donated by Nationalmusei Vänner, Bengt Julin's foundation 2013, Nationalmuseum, NMK 74/2013.



This ambition to renew and develop the art industries is summarised by the motto 'more beautiful wares for everyday use' and 'artists for industry', which the Swedish Society for Arts, Crafts, and Design promoted since 1914 in line with its German sister organisation, the Werkbund.<sup>10</sup> In the case of earthenware, for example, several manufacturers had realised that it no longer sufficed to simply reproduce peasant vessels from the collection at the Nordic Museum, or to copy foreign factory products. To compete on the international market and increase production, it was necessary to hire professional artists and designers who could create products that people actually wanted to buy and could afford. Examples of women designers are Tyra Lundgren (1897–1979), artistic director of the Arabia porcelain factory in Helsinki and the first woman designer at the Venini glassworks outside Venice, Anna-Lisa Thomson (1905–1952), the first permanently employed artist at St Eriks Lervarufabriker, and Maggie Wibom (1899–1961), the first permanently employed woman at Bo Fajans (Fig. 8). Marie-Louise Idestam-Blomberg (1898–1988), who was among the first group of professionally trained furniture designers, opened one of the first interior design companies in Sweden, Futurum.<sup>11</sup> Another woman designer was Sylvia Stave (1908–1994), artistic director of the goldsmiths C.G.

Fig. 8. Anna-Lisa Thomson, Vase 1936, stoneware, glazed, Gefle Porslinsfabrik. Purchase by Nationalmuseum, NMK 129/1936; Vase 'Shell' 1945, earthenware, partially glazed, Upsala-Ekeby. Purchase in 1945, by Nationalmuseum, NMK 60/1945; and Vase, faience, Upsala-Ekeby. Donated by Upsala-Ekeby through director Rolf Sterner 1943, Nationalmuseum, NMK 96/1943.



Fig. 9. Sylvia Stave, Water jug '3834' 1936, electroplated silver, blackened wood, C.G. Hallbergs Guldsmeds AB. Purchase by The Barbro Osher Pro Suecia Foundation, Nationalmuseum, NMK 198/2013.

Hallbergs Guldsmedsaktiebolag. The exhibition included a whole room with her glamorous cocktail shakers, glasses, and coffee sets in silver and German silver, in a Bauhaus-inspired style (Fig. 9). In 2013, the Nationalmuseum had the opportunity to acquire a large collection of her work from the German-Swedish collector and connoisseur Rolf Walter. Since the Museum receives no public funding for acquisitions, it was thanks to the Barbro Osher Pro Suecia Foundation that we could acquire some 40 objects designed by Sylvia Stave.<sup>12</sup>

Sylvia Stave brings us to a fourth reason why successful women designers were so quickly forgotten and neglected, namely marriage. Stave had a blossoming career and her works for C.G. Hallbergs were exhibited at the 1930 Stockholm Exhibition and the 1937 Paris World's Fair. But in 1940, at the age of 31, she married a doctor in France and retired from the design field, to become a housewife. She never worked as a designer again, and when the Italian firm Alessi resumed production of one of her cocktail shakers in 1989, they thought it was designed by the German Bauhaus-trained designer Marianne Brandt. However, Rolf Walter and the Bauhaus archive were able to identify the real designer, Sylvia Stave, and re-establish her name within the design community.<sup>13</sup>

There are indeed several exciting and moving life stories embedded in the project about women pioneers in design. It is with great pleasure that the Nationalmuseum in Stockholm is now collecting objects and filling in the gaps in its inter-war design collection. The Museum building is currently closed for a major renovation, and when we open again in 2018, women designers will feature more prominently in the permanent exhibition.

<sup>10</sup> Gregor Paulsson, *Vackrare vardagsvara* (Stockholm: Svenska slöjdföreningen, 1919); Gregor Paulsson, "Better Things for Everyday Life," in Lucy Creagh, Helena Kåberg, and Barbara Miller Lane (eds.), *Swedish Modern: Three Founding Texts* (New York: The Museum of Modern Art, 2008), 72–125.

<sup>11</sup> Olausson and Karlsson, *Kvinnliga pionjärer*, Sigrid Eklund-Nyström, *Inredningsarkitekt på 1930-talet: Om inredningsfrman Futurum och hur en ny yrkesgrupp etablerar sig* (Stockholm: Nordiska museets förlag, 1992); Maria Perers, "Marie-Louise Idestam-Blomberg: Artist of the 'People's Home,'" *Art Bulletin of Nationalmuseum Stockholm* 22 (2015), 61–70, <http://nationalmuseum.diva-portal.org/smash/get/diva2:991809/FULLTEXT01.pdf> (accessed June 26, 2017).

<sup>12</sup> Magnus Olausson and Micael Ernstell, "Sylvia Stave," in Olausson and Karlsson, *Kvinnliga pionjärer*, 46–52.

<sup>13</sup> Ibid. Alessi, <http://store.alessi.com/and/en-gb/catalog/detail/90021-cocktail-shaker/90021> (accessed June 26, 2017).

**Maria Perers**

Curator of decorative arts and design, Nationalmuseum, Stockholm,  
and PhD candidate, Bard Graduate Center, New York



Maria Perers is a curator of decorative arts and design at Nationalmuseum, Stockholm, and PhD candidate at the The Bard Graduate Center: Decorative Arts, Design History, Material Culture in New York where she is working on her dissertation "Inside the Ideal Home: Changing Values in Apartment Living in Sweden c. 1955-1970." She also lectures in design history at institutions such as Parsons and Cooper-Hewitt in New York and Konstfack, University College of Arts, Crafts, and Design, in Stockholm.

E-mail: [maria.perers@nationalmuseum.se](mailto:maria.perers@nationalmuseum.se)





Ilja S. Meijer

## Cases from Ireland to Finland

### Introduction

The five articles in this section cover a range of different approaches. The article on English architect Mary Crowley applies a straightforward biographical approach and elaborates the formative years of her professional career. The article in which the wall hangings of textile designer and Bauhaus-student Anni Albers are related to the architectural concepts of Gottfried Semper, offers a more analytical approach. Aligning her textile wall hangings with architectural theory, Anni Albers tried to undermine 'gendered distinctions between architectural and textile practices'.

Textile design was strongly integrated into the Bauhaus curriculum. Another article concerned with this field is also related to the Bauhaus. Its main character is Corona Krause, a lesser-known designer whose biographical content presented in this article is based on archival and oral research.

The difficulties women architects experienced in a predominantly male environment is a recurring theme in the articles. One example is the essay about the relatively unknown (and Ireland's first female) architect Florence Fulton Hobson. She anonymously published an article in 1911 where she not only shared her own experiences, but also encouraged future women architects. Another example is the article on Aino Aalto, which reflects on the regularly encountered situation in which the professional careers of women are totally overshadowed in history by their professional and personal male partners.

## Architecture as Method of Self-Realisation: The Belfast Architect Florence Fulton Hobson

Florence Fulton Hobson (1881–1978) was the third woman architect to be licensed by the RIBA. Attended the School of Art in Belfast, was an apprentice in the Belfast practices of James John Phillips and James St John Phillips and worked for Edward Guy Dawber and James Glen Sivewright Gibson in London. After returning to Belfast, she worked for the Belfast Corporation from 1905 as an assistant to the Royal Commission on Health and Housing.

Little is known of her activities for the Belfast Corporation and only a few houses that were designed by her have been identified to date. She wrote, however, about the ways in which she negotiated her role as the only women in an all-male profession in her article "Architecture as a Profession". Here, she analysed and reflected on doubts that were at the time expressed in relation to women practicing as architects. At the same time the text was an aid to women who wished to become architects because it explained how architects are educated and accredited.

Keywords: Florence Fulton Hobson, Ireland, Suffragette, Easter Rising, Belfast, RIBA

Little is known about Florence Fulton Hobson (1881–1978). In 1911 she was the third woman to be licensed by the Royal Institute of British Architects (RIBA) and was the first one from Ireland. The online *Dictionary of Irish Architects*, the *Dictionary of Ulster Biography* and the brochure *Celebrating Belfast Women: A City Guide Through Women's Eyes* dedicate short texts to her<sup>1</sup> and on the basis of the information available here Ryan McBride wrote his unpublished BA Hons dissertation *Houses Designed by Women, for Women* that reiterates her biography and discusses one of her houses.<sup>2</sup>

Her life and significance as the first RIBA licensed Irish woman architect furthermore inspired the novelist Marina J. Neary to write two novels within which she and her family take a central place.<sup>3</sup> The extent of Fulton Hobson's architectural oeuvre has yet to be researched and this paper focuses on providing an account of her career and, more importantly, on discussing her 1911 article "Architecture as a Profession".

### Life

Fulton Hobson was born in 1881 in Monasterevin, County Kildare but grew up in Belfast where her family had moved to by 1883. Her family (Fig. 1) were Quakers and her English mother Mary Ann

1 "Hobson, Florence Fulton," *Dictionary of Irish Architects 1720–1940*, <http://www.dia.ie/architects/view/5010/HOBSON-FLORENCEFULTO> (accessed August 27, 2016); Kate Newmann, "Florence Hobson," *Dictionary of Ulster Biography*, <http://www.newulsterbiography.co.uk/index.php/home/viewPerson/692> (accessed February 2, 2017); and *Celebrating Belfast women: A city guide through women's eyes* (Belfast: Women's Resource & Development Agency, [s.a.]), 22, <https://wrda.net/pdf/celebrating%20belfast%20women%20-%20tour%20guiding%20booklet.pdf> (accessed August 27, 2016).

2 Ryan McBride, "Houses Designed by Women, for Women," (BA Hons thesis, Ulster University, 2015).

3 Marina Julia Neary, *Martyrs & Traitors: A Tale of 1916* (Maine: All Things that Matter Press, 2011); Marina Julia Neary, *Never Be at Peace* (Tucson, AZ: Fireship Press, 2013).

Bulmer Hobson (1856–1947) was a hobby archaeologist,<sup>4</sup> active Suffragette and founder –together with the poet and writer Alice Milligan (1865–1953)– of the Irish Women’s Association in Belfast.<sup>5</sup> Fulton Hobson’s younger brother, John Bulmer Hobson (1883–1969), is the best-known member of the family. He was a leading member of the Irish Volunteers, and the Irish Republican Brotherhood before the Easter Rising in 1916 and he had a pivotal role in the political developments in Ireland at that time.<sup>6</sup>

Fulton Hobson attended the School of Arts in Belfast and was an architectural assistant in the practice of James John Phillips (1841/42–1935) and his son James St John Phillips (1870–1935) between 1899 and 1903.<sup>7</sup> After moving to London she was first a temporary assistant to Guy



Fig. 1. Family Photograph, ca. 1922. Florence Fulton Hobson is standing to the left hand side. Her mother Mary Ann Hobson (née Bulmer) is seated in front of her. John Bulmer Hobson sits to the right hand side of the image. Courtesy of the family (private collection).

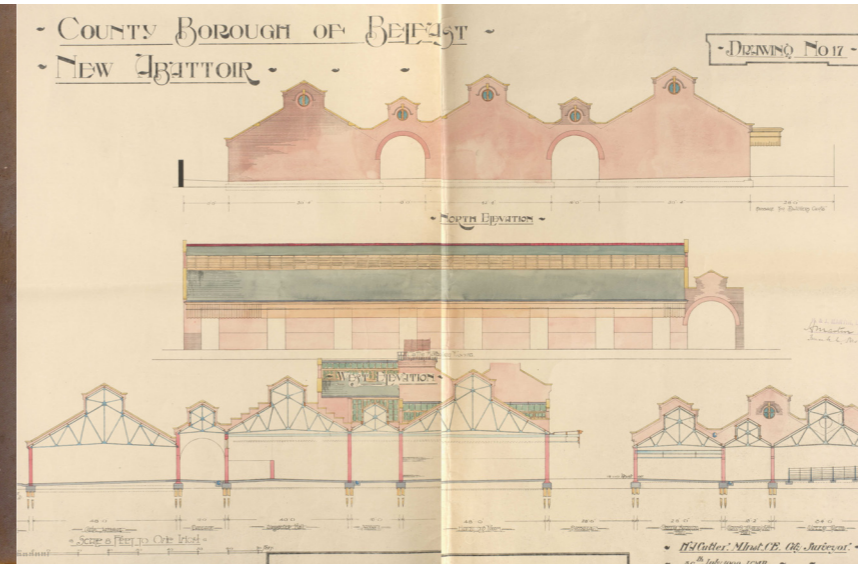

Fig. 2. Henry Albert Cutler, New Abattoir, Drawing no. 17, North Elevation, West Elevation, Belfast, 1909. Courtesy of ‘The Deputy Keeper of the Records, Public Record Office of Northern Ireland’, LA/7/8/JA/3/17.

Dawber<sup>8</sup> (1861–1938), who ran a large practice that specialised in stone-built country houses in Tudor or late Stuart styles, and later took employment with James Glen Sivewright Gibson<sup>9</sup> (1861–1951). Here, she was involved with the

work on the Neo-Baroque Town Hall in Walsall near Birmingham.<sup>10</sup> Fulton Hobson returned to Belfast and in 1906 and became a temporary assistant in the Surveyor’s Department at the Belfast Corporation where she made working drawings for an Electric Generation Station.<sup>11</sup> After travelling privately on the Continent to study architecture for three months she commenced working for the Royal Commission of Health and Housing, also at the Belfast Corporation. Here, she appears to have worked between 1907 and 1921. Up until 1911 she was involved with the erection of ten workmen’s dwellings in Portadown, a Presbyterian Church on Grosvenor Road in Belfast, a disinfecting station, and a public abattoir that was designed by the architect Henry Albert Cutler<sup>12</sup> (1861–1952) (Fig. 2).

Shortly after she had become a licentiate to the RIBA in 1911 she anonymously published the article “Architecture as a Profession.”<sup>13</sup> Little is known about her later career at the Belfast Corporation or her private practice. In 1913 she gave the public talk “Town Planning and its Relation to Public Health” at the Belfast Public Library. It encompassed topics such as the ethics of town planning, modern legislation, and social housing. She also built several houses at Carnalea (Figs. 3 and 4), south of Belfast, a bungalow in Killiney (Fig. 5), near Dublin and made alterations to the 1810

4 Mary Ann Bulmer Hobson was active in the Belfast Naturalists’ Field Club and is frequently mentioned in the Annual reports between 1904 and 1913, especially in relation to her interest in ‘Souterrains’ or cave dwellings. In 1904 her daughter Florence is mentioned as having made sketches and plans. “Some Souterrains in Antrim and Down,” *Annual Report & Proceedings: Belfast Naturalists’ Field Club Series 2*, vol. 5, part 3 (1903–4), 213–214. See also “Lecture on ‘Deneholes and Souterrains,’” *Annual Report & Proceedings: Belfast Naturalists’ Field Club Series 2*, vol. 5, part 5 (1905–6), 425–426, <https://archive.org/stream/s2annualreportsp05belfuoft#page/n5/mode/2up> (accessed June 16, 2017). In 1947 her *Memoirs of Six Generations*, which is a Chronicle of her family, was published. Mary A. Bulmer Hobson, *Memoirs of Six Generations* (Belfast: Graham and Heslip Ltd., 1947).

5 Catherine Morris, *Alice Milligan and the Irish Cultural Revival* (Dublin: Four Courts Press, 2013).

6 Marnie Hay, *Bulmer Hobson and the Nationalist Movement in Twentieth-Century Ireland* (Manchester: Manchester University Press, 2009); Kate Newmann, “Bulmer Hobson (1883–1963), Writer and Revolutionary,” *Dictionary of Ulster Biography*, <http://www.newulsterbiography.co.uk/index.php/home/viewPerson/691> (accessed January 1, 2017).

7 Biographical details on her professional work: “RIBA Nomination File ‘Florence Patterson’. Candidate’s Separate Statement, December 3<sup>rd</sup>, 1910,” in The Royal Institute of British Architects, *Licentiate Florence Fulton Hobson Student RIBA*, London, November 29<sup>th</sup>, 1910. In addition to her architectural work, this CV also lists two publications “Some Ulster Stone Monuments in Antrim co. Down” (1910) and “Some Ulster Souterrains” (1910). Her mother wrote the texts but both articles were illustrated with Fulton Hobson’s drawings of ancient stone monuments and underground structures. Information on her work after 1911 is contained in: Florence Fulton Hobson, “Hand-written Curriculum Vitae,” not dated (c. 1921). This manuscript is in the collection of Fulton Hobson’s family. Her successful completion of the preliminary and intermediate RIBA exams in 1903 didn’t go unnoticed and the Belfast architect W. J. Fennell welcomed her in a public lecture on “Early English Architecture” among the ranks of architects and ‘... was glad to see that there was at least one lady in Belfast who had the pluck to serve her time to architecture, and had passed the Royal Inst. Of British Architects...’ “Lecture by Mr. W. J. Fennell FRIBA on ‘Early English Architecture’ at Municipal Technical Institute (extract),” *The Northern Whig*, Monday February 9, 1903 in The Royal Institute of British Architects, *Licentiate Florence Fulton Hobson Student RIBA*, London November 29, 1910.

8 “(Sir) Edward Guy Dawber,” *Dictionary of Scottish Architects: Architect Biography Report*, [http://www.scottisharchitects.org.uk/architect\\_full.php?id=203314](http://www.scottisharchitects.org.uk/architect_full.php?id=203314) (accessed, August 15, 2016).

9 “Glen Sivewright Gibson,” *Dictionary of Scottish Architects: Architect Biography Report*, [http://www.scottisharchitects.org.uk/architect\\_full.php?id=100337](http://www.scottisharchitects.org.uk/architect_full.php?id=100337) (accessed, August 15, 2016).

10 RIBA Nomination File ‘Florence Patterson’.

11 Fulton Hobson, “Hand-written Curriculum Vitae.”

12 “Cutler, Henry Albert,” *Dictionary of Irish Architects 1720–1940*, <http://www.dia.ie/architects/view/896/CUTLER-HENRYALBERT> (accessed August 10, 2016).

13 Anonymous [Florence Fulton Hobson], “Architecture as a Profession,” *The Queen: The Lady’s Newspaper*, December 23, 1911. Her being licensed by the RIBA was reported also in *The Queen* shortly after her article had been published. “Public Work and Women’s Employment,” *The Queen: The Lady’s Newspaper*, February 17, 1912, 284.



Fig. 3. Florence Fulton Hobson, House at Carnalea Co. Down, 1914–15.  
Courtesy of Gary Quigg Photography.



Fig. 4. Florence Fulton Hobson, House at Carnalea Co. Down, 1920–21.  
Published in Maire Garvey, "Ireland's First Women Architect," *The Crystal* (September 1927), 263.



Fig. 5. Florence Fulton Hobson, Bungalow in Killiney near Dublin, c. 1921.  
Courtesy of Gary Quigg Photography.

Glendun Lodge in Cushendun.<sup>14</sup> Fulton Hobson also worked for the Reconstruction Commission of the Irish White Cross Society before the initiation of the Free State in 1922.<sup>15</sup> The Irish White Cross had been organised in 1920 to obtain funds to alleviate the effects of civil war in Ireland.<sup>16</sup>

The only publication that illustrated and discussed Fulton Hobson's houses was the 1927 article "Ireland's First Women Architect" by Maire Garvey in the magazine *The Crystal*<sup>17</sup>. It featured images of two of the houses that Fulton Hobson had built in Carnalea as well as one floor plan (Figs. 3 and 4).

Around 1930 she ran the craft shop, Dunluce Handcrafts, in Bushmills, Co. Antrim and retired in 1936. In 1947 she married William Forbes Patterson and appears to have lived in London until the 1960s but returned to Carnalea where she died in 1978 at the age of 97.

### Architecture as a Profession

The most compelling insights to the ways in which Fulton Hobson experienced her education and early practice as an architect are given in her article "Architecture as a Profession". The article begins by explaining that architecture is suitable for those –men and women– who combine artistic ability and 'practical common sense' and continues to summarise several preconceptions concerning women architects:

Many people declare that women should be domestic architects, and that they would no doubt excel in house designing on account of their special knowledge of domestic arrangements, but this is about as far as they are willing to go; any larger sphere of work has probably never presented itself to the minds of the majority of people. There certainly is an idea abroad that a woman could not superintend the erection of a high building or supervise workmen. It is thought that she could not possibly go up a ladder in a skirt, and that, although she might be everything that could be desired as a designer of houses to live in (for who knows the dwellers' requirement better than she?), yet to look after all the details of house erection would be something entirely outside her sphere, and unsuitable, if not impossible.<sup>18</sup>

This statement as well as the remainder of the article displays comprehensive knowledge and involvement in the discussion about women in architecture that had commenced in Britain around 1900 when Ethel Mary Charles (1871–1962) and her sister Bessie Ada Charles (1869–1932) had

<sup>14</sup> Fulton Hobson, "Hand-written Curriculum Vitae."

<sup>15</sup> Maire Garvey, "Ireland's First Woman Architect," *The Crystal: Modern Ireland Mirrored* (September 1927), 264.

<sup>16</sup> Ibid.

<sup>17</sup> Ibid.

<sup>18</sup> Anonymous, "Architecture as a Profession."

become associate members of the RIBA in 1898 and in 1900. Some of the wording of Fulton Hobson's article allows for the assumption that she was familiar with the article, "May Women Practise Architecture?",<sup>19</sup> that was published in 1902 in *The British Architect* and that reported on a talk by Ethel Mary Charles.

The argument, that women are best suited to be domestic architects, can be found in both articles and was related to the notion that the realm of women is the domestic one. Domestic architecture hence provided a 'natural' niche for women architects. Female spheres and experiences were linked with newly acquired expertise in architecture. This could be seen, as Despina Stratigakos has shown, as an attempt to reconcile the perceived opposite spheres of women in the workplace with women in the domestic realm. Using the first German women architect Emilie Winkelmann (1875–1951), as an example the reporter Fritz Daussig explained in 1909 that designing single-family homes would help women to remain feminine and would 'preserve the best female qualities in their professional work'<sup>20</sup> since house design should come 'naturally' to women architects.

Fulton Hobson's remark that a women architect would find it difficult to supervise contractors or builders referred to social expectations about gendered behaviour.<sup>21</sup> The social homogeneity of the all-male work place was disrupted by a female presence and created unease. Fulton Hobson regarded such diffidence as unnecessary because architects are gentlemen and behave politely to everyone in the office.<sup>22</sup>

Her comment that skirts make the climbing of ladders a problematic exposure<sup>23</sup> appears to have related to the observation that male architects were able to transgress class boundaries between construction workers and fellow middle-class architects through wearing clothes appropriate for the building site. This way they would be seen as knowledgeable master architects as well as craftsmen. It would have been scandalous for the lady architect to attempt the same.<sup>24</sup>

The notion that women could not climb a ladder was also linked to a broader discourse concerning the perceived inferior physicality of the female body. Such concerns went, as outlined by architectural historians Lynne Walker and Despina Stratigakos, hand-in-hand with fears that a third gender

would be created, that athletic bodies would lead to female impotence, or that women would become 'masculine'.<sup>25</sup>

The beginning of Fulton Hobson's article outlined objections towards women architects but it also provided the female reader with counter-arguments should she too have to tackle similar views and obstacles. Fulton Hobson's text also addressed practical issues such as how to find an architect willing to give a woman the opportunity to work in his office. In giving insights into the daily operations of an architectural practice, she provided her readers with clues as to why an architect might be reluctant to accept female apprentices which also equipped the reader with knowledge that might help to persuade a prospective employer.<sup>26</sup> The article explains the costs and length of tutelage, gives details about the three qualifying examinations by the RIBA and provides a list of schools where architecture is taught.

She closes her article with a word of warning to the architectural aspirant: she should not seek architecture as a profession unless she is strongly drawn to it. In citing the text *De Profundis* written by Oscar Wilde (1854–1900) to Lord Alfred Douglas (1870–1945) from prison between 1896 and 1897<sup>27</sup> this last paragraph takes a serious tone and is as such separated from the more ironic or matter-of-fact spirit of earlier passages:

Those who undertake something that is not part of themselves will achieve that, but will be nothing more; that if they start with the ideal of being the parish beadle, in whatever sphere they are placed they succeed in being the parish beadle and no more. A man whose desire is to be something separate from himself ... invariably succeeds in being what he wants to be. That is his punishment. Those who want a mask have to wear it.<sup>28</sup>

For Wilde, *De Profundis* was a reflective piece in which he deliberated the meaning of the identity of the artist and the 'self'.<sup>29</sup> This had been an integral part of Wilde's work and he had been particularly

25 Stratigakos, "Architects in Skirts," 90–2; Lynne Walker, "The Entry of Women into the Architectural Profession in Britain," *Woman's Art Journal* 7, no. 1 (1986), 13–18. See also Lynne Walker, *British Women in Architecture 1671–1951* (London: Sorello Press, 1984).

26 Anonymous, "Architecture as a Profession."

27 The title *De Profundis* was added by Robert Ross but Wilde named the letter *Epistola: In Carcere et Vinculis*. "Manuscript of 'De Profundis' by Oscar Wilde," *British Library: Manuscript/Letter*, <https://www.bl.uk/collection-items/manuscript-of-de-profundis-by-oscar-wilde> (accessed January 2, 2017). It is not known which edition Fulton Hobson used. If she read the first edition of 1905, it would not have contained any reference to Douglas and their relationship because the publishers feared being sued for libel and removed some passages. The text therefore would not have read as a love letter but presented itself as a reflective piece on the life of the artist. Fulton Hobson nevertheless will have been aware of the reasons why Wilde had been incarcerated.

28 Anonymous, "Architecture as a Profession."

29 Elaine Hernen, "Names are Everything: For Oscar Wilde, Posing as a Letter and Visiting Card," 219, <http://open.conted.ox.ac.uk/resources/documents/names-are-everything-oscar-wilde-posing-letter-and-visiting-card-elaine-hernen-224-5> (accessed, 22 August, 2016).

19 "May Women Practise Architecture?" *The British Architect*, February 21, 1902, 125.

20 Fritz Daussig, "Ein weiblicher Architekt," *Daheim* 45–48 (1909), 11, as cited in Despina Stratigakos, "Architects in Skirts: The Public Image of Women Architects in Wilhelmine Germany," *Journal of Architectural Education* 55, no. 2 (November 2001), 97.

21 Stratigakos, "Architects in Skirts," 92–4.

22 Anonymous, "Architecture as a Profession."

23 "May Women Practise Architecture?," 125.

24 Stratigakos, "Architects in Skirts," 92–4.

interested in exploring the meaning of identity within the constraints of social conventions.<sup>30</sup> Fulton Hobson's reading of Wilde was therefore inspired by the notion in which a person and their art amalgamate.

The reader at the time would have related the term 'parish beadle' to a lay official of a church or local administration who carried out various duties within charitable organisations. The most prominent parish beadle, Mr. Bumble, had been portrayed by Charles Dickens in his 1837–39 novel, *Oliver Twist*, as a pompous character engrossed with his idea of duty and power over others which overrides emotions of empathy or compassion. In *De Profundis* the term 'parish beadle' served Wilde as an example for an occupation that might bring with it importance, power, or respect but that might not necessarily amalgamate with a person's identity. The passage cited by Fulton Hobson in her article therefore was a warning that a profession should not be chosen because of a perception of it. If it is chosen for what it stands for rather than for what it means for oneself, it will become a mask and as such it will never be part of the self. The punishment of wearing such a mask is to never be able to merge the idea of an occupation with the true self. Fulton Hobson closed her article with the advice that architecture is only suitable as a profession for those 'who feel that it is the medium through which they can express themselves best and in which architecture is their method of self-realisation'.<sup>31</sup> An occupation should support one's identity and provide the knowledge and skills necessary to develop and nourish it.

## Conclusions

When women began to enter the profession of architecture around 1900 many reasons were brought forward that sought to explain why their gender was a hindrance to their ability to fulfil the duties and responsibilities of an architect. Within this discourse, very little opinion was expressed that women lacked the necessary intelligence or may have been unable to learn all required skills. Most criticism related instead to practical factors regarding social conventions and class.

Fulton Hobson's article was written in reaction to such notions and intended to be an encouragement for women to enter the field of architecture. In providing her readers with a number of counter-arguments she displayed her awareness of what it meant to have transgressed social boundaries and stratifications that expected women to fulfil a role described and prescribed by conventions. For the woman architect, no guidance existed to aid her in navigating social interactions in the workplace, in talking to a builder, in choosing the appropriate dress for the office and for the building site, or in approaching a client. In this way, she was placed outside societal norms and had to find

<sup>30</sup> Ibid., 220.

<sup>31</sup> Anonymous, "Architecture as a Profession."

ways that, on one hand, could counteract criticism and prejudice and that, on the other hand, helped her to be recognised as a professional.

Fulton Hobson's ultimate goal was, nevertheless, more than to provide a guidance to architectural education or to give instructions as to how to recognise and respond to prejudices. She cautioned her reader that the achievement of being a women architect should not be an end in itself. The struggle to become an architect is merely the means to the end of becoming what she considered to be her true identity and a fulfilment of herself. Fulton Hobson's main concern was that future women architects would reflect on what it means to find self-realisation as a woman and an architect in one person.

## Acknowledgements

Without the help of Florence Fulton Hobson's great-nephew Roger Mitchell, who provided me with family photographs, documents, drawings and other material that is still in the family's collection, it would not have been possible to write this paper. I would like to express my sincere thanks to him and his family for their ongoing confidence, support and interest in this research. I would also like to thank Prof. Peter Walker as it was he who brought Florence Fulton Hobson to my attention. Finally, I must thank Ryan McBride, who wrote his BA Hons dissertation on her life and work. His research and literature review were of great help and accelerated the writing of the biographical part of this paper.

**Tanja Poppelreuter**

Belfast School of Architecture, University of Ulster



Tanja Poppelreuter is a Lecturer in Architectural History and Theory at the University of Ulster in Belfast. Her research interests lie in the field of 20th-century art and architectural theory with the focus on the impact of politics, sociology and medicine on these fields as well as on the question of how utopian ideas developed and took shape in modern society.

E-mail: [t.poppelreuter@ulster.ac.uk](mailto:t.poppelreuter@ulster.ac.uk)



## Mary Crowley: Beginnings of the Career of a Pioneering Modern Movement Architect in Britain before 1945

Mary Crowley (1907–2005) was an exceptional Modern Movement architect yet her contribution is largely unrecognised and overlooked. This article looks at her pre-war background, training and early works. Mary grew up in the utopian Garden Cities at Letchworth and Welwyn when they were being established. She trained at the Architectural Association (AA) in 1927, just ten years after the school allowed women to join. After graduating in 1932 she became an associate of the Royal Institute of British Architects (RIBA) in 1934. Her early works include a group of three houses for her family influenced by Scandinavian Modernist ideas. She worked with other Modernist architects including Ernö Goldfinger and Maxwell Fry and was involved in the British Pavillion of the *Exposition Internationale des Arts Techniques dans la Vie Moderne Paris 1937* designed by Oliver Hill. After 1945, she worked at the newly formed Hertfordshire Architects Department and at the Ministry of Education's Architects and Building Branch.

Keywords: Mary Crowley, Medd, schools, Modern Movement, Sewell's, Hertfordshire

### Utopian Beginnings

Mary Crowley was born in Bradford in 1907<sup>1</sup> into a Quaker family rooted in the idealism and utopian experimentation of Quaker industrialists, Joseph and Seebohm Rowntree and Ebenezer Howard, and their concept for garden cities. These ideas initially shaped the 150 acre site model village at New Earswick near York and then the Garden Cities in Letchworth and Welwyn where Mary grew up and lived.<sup>2</sup> Parker and Unwin were commissioned to design New Earswick and two years later they started work in 1903 on the first Garden City at Letchworth.<sup>3</sup>

Ebenezer Howard's Garden City<sup>4</sup> movement was a reaction to the overcrowding and industrial pollution of Victorian cities. He drew on Quaker precedents at Port Sunlight, Bournville and Robert Owen's 'Vision for a new society', which envisioned 'a happy home for many generations of children where they will be brought up amid surroundings that will benefit them spiritually, mentally and physically'.<sup>5</sup>

Mary's father, Ralph Crowley 'became one of the pioneers of the Garden City Movement and at the heart of this utopian idealism was the education and social welfare of children. Ralph Crowley believed that, as he wrote, 'a doctor cannot fulfil his more specific function of treating bodily diseases, if he is indifferent to the patient's environmental conditions and his mental and moral welfare.'<sup>6</sup> Following Ralph's recruitment to the Board of Education in London in 1908, the family

1 Louise Brodie talking to Mary Medd, August 7, 1998, British Library, National Life Story Collection: Architects' Lives, National Life Story Collection: Architects' Lives, British Library C467/29, Medd, Mary, Part 1 of 11, <http://sounds.bl.uk/Oral-history/Architects-Lives/021M-C0467X0029XX-0001V0> (accessed July 6, 2017),.

2 See respectively Seebohm Rowntree, *Poverty, A Study of Town Life* (London: Macmillan Publishers 1901); Ebenezer Howard, *To-morrow: A Peaceful Path to Real Reform* (London: Swan Sonnenschein & Co 1898); Joseph Rowntree Foundation, "History of New Earswick," <https://www.jrft.org.uk/community/new-earswick-york>, accessed 4 January, 2016.

3 Walter Creese (ed.), *The Legacy of Raymond Unwin: A Human Pattern for Planning* (London and Cambridge Massachusetts: MIT Press 1966), 1.

4 Howard, *To-morrow*.

5 Alan Powers, *Hovels to Highrise: State Housing in Europe Since 1850*, (London: Routledge 1993),175.

6 "Obituary, Ralph Crowley MD Lond FRCP," *The Lancet*, October 10, 1953, 785.

moved from Bradford to the newly founded Garden City in Letchworth, Hertfordshire and then in 1920 to the recently established second Garden City in Welwyn.<sup>7</sup>

When the family moved to Welwyn Garden City in 1921 Mary was sent to Bedales,<sup>8</sup> a pioneering co-educational school founded by John Haden Bradley, which offered an alternative model to traditional English Public Schools. Mary found expression for her talents in drawing, music and art and spent many hours sketching in the (now Grade 1 Listed) Arts and Crafts Library with its double height timber structure dramatically top lit like a cathedral clerestory designed by Ernest Gimson.<sup>9</sup> After she left Bedales she spent a few months with a Swiss family in Lausanne to improve her French in 1926 before enrolling at the Architectural Association (AA) in London in 1927.<sup>10</sup>

### Education and Social Change

Mary was training for a profession at a time of great political and social change. It had only been 10 years since the suffragette Ruth Lowy persuaded AA Council to consider allowing women to be educated at the AA. Mary was not even eligible to vote until she entered her second year at the AA when Parliament passed the Representation of the People (Equal Franchise) Act on 2 July 1928. In this same period, political tensions in Germany saw waves of émigrés flocking into London, including architects and designers Walter Gropius, Marcel Breuer, Erich Mendelsohn, Ernő Goldfinger, Arthur Korn and László Moholy-Nagy, and the Russian architects Serge Chermayeff and Berthold Lubetkin.<sup>11</sup>

AA records show that Mary was a highly conscientious student who managed to get consistently high marks. She took full part in student activities including a stunning role in the Finale of the 1929 AA Pantomime with the choreography by Carmen Dillon (Fig. 1).<sup>12</sup> Mary was the only student to have won the AA's Travelling Studentship four years running in her second, third, fourth and fifth years. She also had her work published in the AA Journals and won the fiercely competitive



Fig. 1. AA Pantomime 1929, Mary Crowley far right. Courtesy of Architectural Association Photo Library.

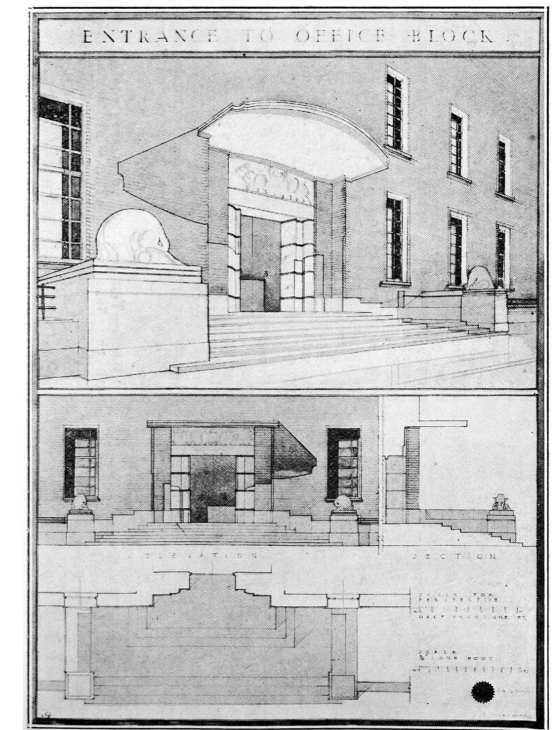

Fig. 2. Pottery Offices Entrance illustrated in *The AA Journal* 46, no. 522 (August 1930), 88. Courtesy of Dennis Sharp Archive.

and much coveted final year prize in 1932. The 1930 issue of the AA Journal includes Mary's third year project- a Modernistic rendering of an entrance to an office block (Fig. 2). The article shows a range of styles that were being explored from classical *An Application of the Orders* (Second Year, P. Cornit) to modern expressionism *Esquisse for an Island Belvedere* (Third Year W. P. Dyson).<sup>13</sup>

Her professional training at the AA and Travelling Studentships enabled her to travel to Scandinavia and Europe with her peers including Oliver Hill, Norah Aiton and others who pioneered Modernism in Britain. The trip to Scandinavia in 1930 was to be one of the most formative experiences of her student life. Organised by F.R. Yerbury, a group of 93 students and staff set off from St Pancras on 16 July 1930 a few days after she was presented the Third Year Course AA Travelling Studentship for £31.10s. Travelling by train and boat the group spent two days in Gothenburg, five in Stockholm and four in Copenhagen.<sup>14</sup> Photographs of the buildings visited were exhibited at the AA from 24 November to 20 December 1930 and a detailed account of the trip was published in the December issue of the *AA Journal* (Fig. 3).<sup>15</sup> The trip included visits to a number of new innovative schools in Gottenburg by Arvid Bjerke and Gunnar Asplund, and in Stockholm the group saw a new school by

7 Frederic James Osborn, F.J., *Green-belt Cities* (London: Faber & Faber, 1946), 36.

8 John Haden Badley, *Bedales: A Pioneer School*, (London: Methuen 1923).

9 Historic England (March 16, 1954, updated August 11, 1968) List Entry 1278033, Bedales Memorial Library, Lupton Hall and Corridor, <http://historicengland.org.uk/listing/the-list/list-entry/1278033> (accessed November 3, 2015).

10 Louise Brodie talking to Mary Medd, September 7, 1998, National Life Story Collection: Architects' Lives, British Library C467/29, Medd, Mary, Part 2 of 11, <http://sounds.bl.uk/Oral-history/Architects-Lives/021M-C0467X0029XX-0001V0> (accessed July 6, 2017).

11 Charlotte Benton, *A Different World: Émigré Architects in Britain 1928–1958*, (London: RIBA 1995).

12 HMSC, "AA Pantomime 1929," *The AA Journal* 45, no. 515 (January 1930), 280–283. Carmen later won an Oscar in 1949 for the Best Art Direction-Set Decoration for the 1948 Olivier version of Hamlet and was nominated for a number of BAFTA's and won an Emmy Award in 1975. Ronald Bergen, "Carmen Dillon: Oscar winning art director setting the scene for great British films," *Guardian*, April 21, 2000.

13 Frederic Etchells, "Exhibition of Students' Work," *The AA Journal* 46, no 522 (August 1930), 82–92.

14 A. A. "Excursion to Sweden and Denmark, 1930," *The AA Journal* 46, no. 526, (December 1930), 179–95; "The A.A. Visit to Sweden and Denmark," *The AA Journal* 46, no. 522, (August 1930), 104–6 and 81.

15 Ibid.

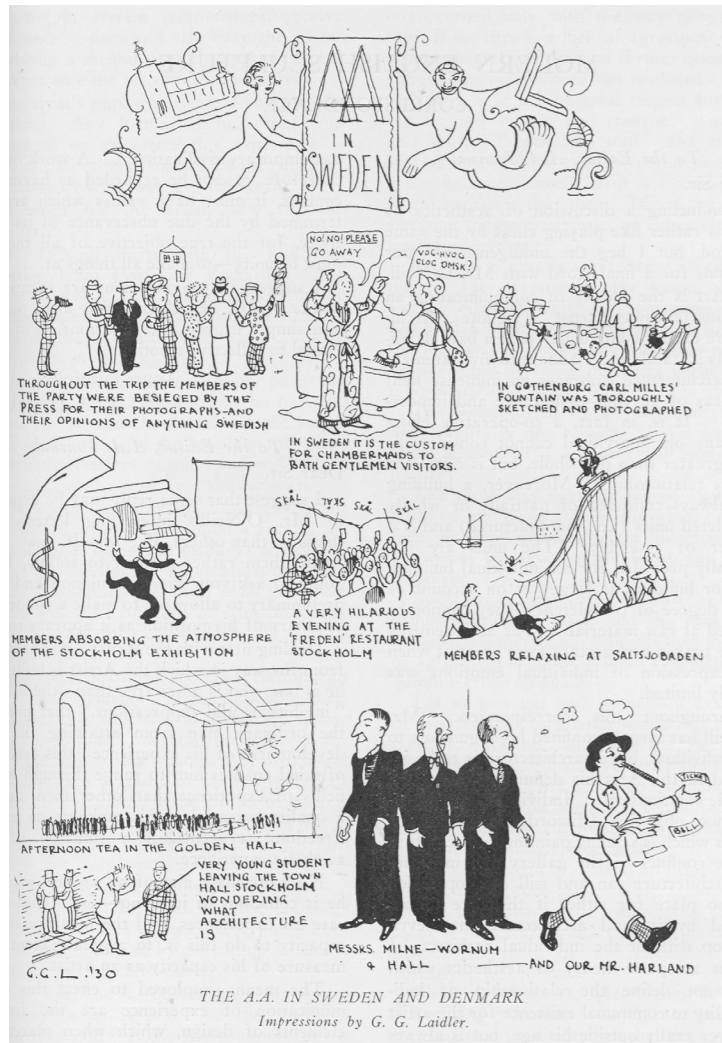

Fig. 3. Cartoon by G Laidler illustrating the Highlights of the 1930s AA visit to Stockholm. *The AA Journal* 46, no. 526 (December 1930), 195. Courtesy of Dennis Sharp Archive.

Hakon Ahlberg and a technical school by Eric Lallerstedt containing a fountain by Carl Milles. The main highlight of the tour was the newly completed Stockholm Town Hall and Asplund's Paradiset Restaurant in the Stockholm Exhibition. The exhibition's slogan was *Acceptera!*, or *Accept!*, literally a plea for acceptance of functionalism, standardization, and mass production as a cultural change. It also underlined the social and economic basis of the architecture designed, revealing the architect as 'a worker in the service of the broad masses of the community.'<sup>16</sup>

After the 1930 trip Modernism could no longer be ignored and Goodhart-Rendel's address to the AA General Meeting on 23 February 1931, when Mary was in her fourth year, gives an insight into the debates around stylistic attitudes:

I believe that much of our advanced architecture is in danger of being strangled by style-consciousness....I think that I recognise in most of the best recent architecture of France and

<sup>16</sup> Dennis Sharp, *A Visual History of Twentieth Century Architecture* (London: Heinemann 1972), 114.

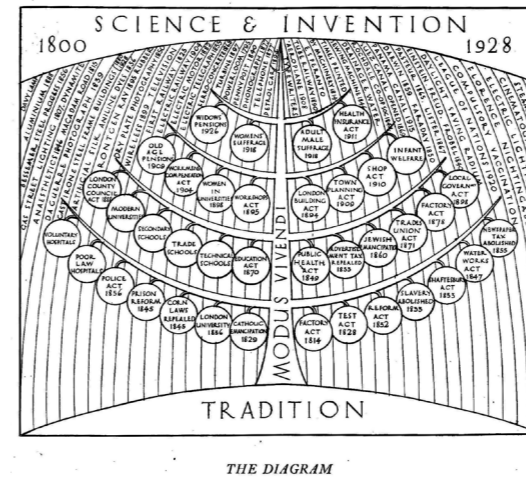

Fig. 4. 'The Diagram' illustrating major advances in science and invention with political and social events 'modus vivendi' used to illustrate Mr Duncan's opening speech at an AA General Meeting held on 27 May 1929 on "Modern Tendencies in Architecture and the other Arts," *The AA Journal* 45, no. 508 (June 1929), 7. Courtesy of Dennis Sharp Archive.

in some parts of Scandinavia and Germany a modern real style that has evolved naturally from changing practice in construction and changing fancies in ornament. ...In more backward countries the modern style is conceived of as a style of pure negation, its aesthetic weakness bolstered up by mechanical theory or unintelligible philosophy (Fig. 4).<sup>17</sup>

Mary's fourth year project for An Institute of Archaeology, published in the February issue of the *AA Journal*, (Fig 5) looks remarkably like the 1934 RIBA Headquarters which was influenced by Östberg's Town Hall and Asplund's City Library in Stockholm.<sup>18</sup> In her final year, 1932, she had two of her projects published in the *AA Journal*: *A British Centre for Arts and Sciences in France* fifteen kilometres from Paris on the banks of the Seine, and her thesis subject which was *An Educational Centre for a Town of 25,000 Inhabitant* (Fig 6).<sup>19</sup> The Educational Centre is remarkably futuristic with curtain walling along one elevation and Scandinavian style Modernist treatment on the other. In this final thesis she mentions the school system of Gary, Indiana that her father had visited in 1913 and the first of Henry Morris' village colleges in Sawston (the precursor to Gropius's Impington). Mary left the AA at the top of her class, winning the highly coveted medal from the *Société des Architects Diplômés par le Gouvernement*, Paris, a prize for the best Diploma student of

<sup>17</sup> Harry Stuart Goodhart-Rendel, "Growing Pains," *The AA Journal* 46, no. 529 (March 1931), 283.

<sup>18</sup> "AA School Fourth Year Project," *The AA Journal* 46, no. 528 (February 31), 269-73.

<sup>19</sup> Respectively in *The AA Journal* 48 no. 545 (July 1932), 52 and 55, and *The AA Journal* 48, no. 548 (October 1932), 103.

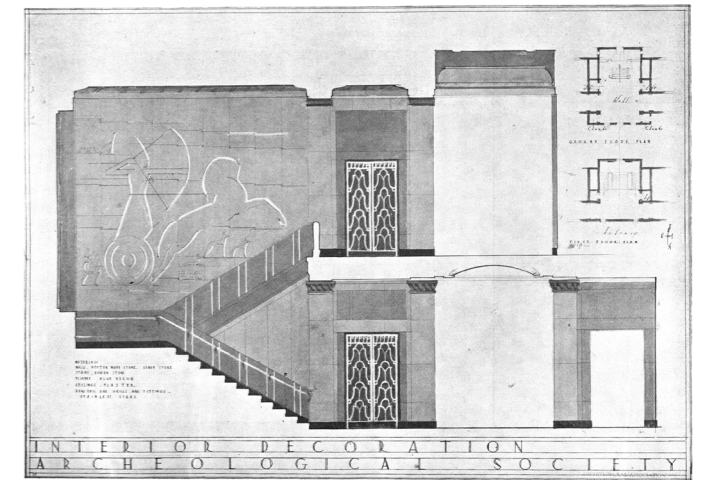

Fig. 5. The Institute of Archaeology, 4<sup>th</sup> Year project by Mary Crowley illustrated in *The AA Journal* 46, no. 528 (February 1931), 272. Courtesy of Dennis Sharp Archive.

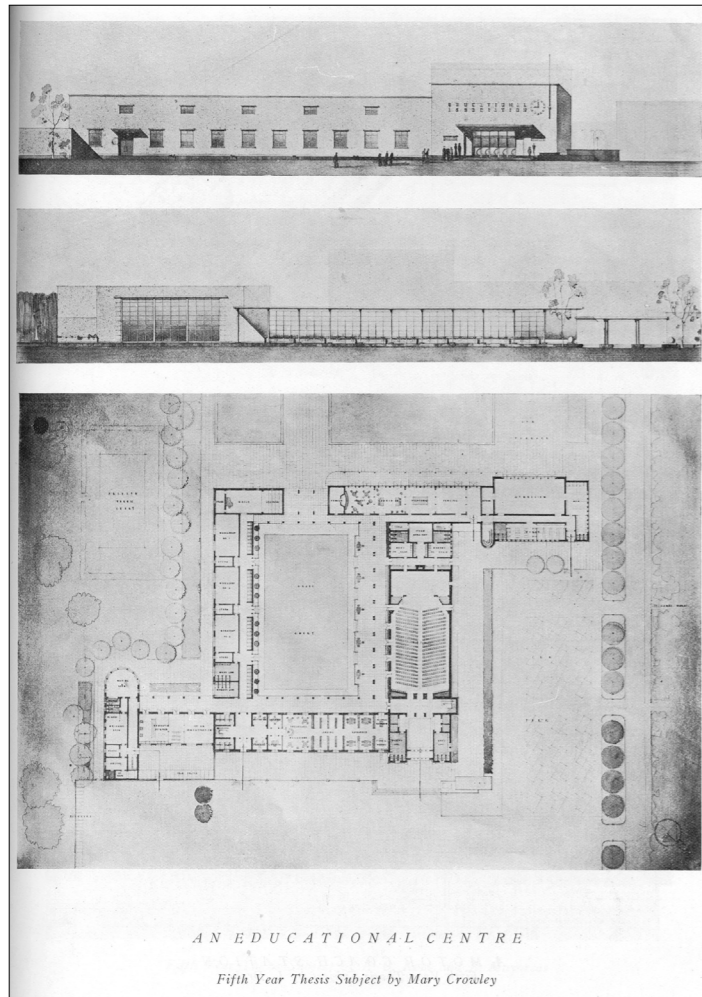

Fig. 6. An Educational Centre, Fifth Year Thesis Subject by Mary Crowley, *The AA Journal* 48, no. 548 (October 1932), 103. Courtesy of Dennis Sharp Archive.

the session. She was also awarded the Henry Florence Travelling Studentship (£50).<sup>20</sup> While studying at the AA Mary also gained seven months experience working in the office of the architect of Welwyn Garden City, Louis de Soissons (who retired from AA Council in 1929).<sup>21</sup>

### Early Practice

Mary left the AA at a time of the Great Depression (1929–33) when there was a serious economic downturn and work was sparse. Her family were amongst her first clients. In 1934 she started working independently on a group of three houses at Sewell's Orchard, Tewin, for her parents, her sister Elfrida and brother-in-law - Elfrida had married architect Cecil Kemp,<sup>22</sup> who became the Chief

<sup>20</sup> *The AA Journal* 48, no. 545 (July 1932), 41–2.

<sup>21</sup> RIBANPA\_5426\_Crowley\_Mary\_1934\_1–5 (February 9, 1934), Royal Institute of British Architects (RIBA), London.

<sup>22</sup> "Six pithead baths erected by the Miners' Welfare Committee: Architects: J. H. Forshaw, C. G. Kemp," *Architectural Review* (1941), 79–80.



Fig. 7. A view of Kemp House taken in 2007 with a single extension on the side, designed by the author. Courtesy of Dennis Sharp Architects.

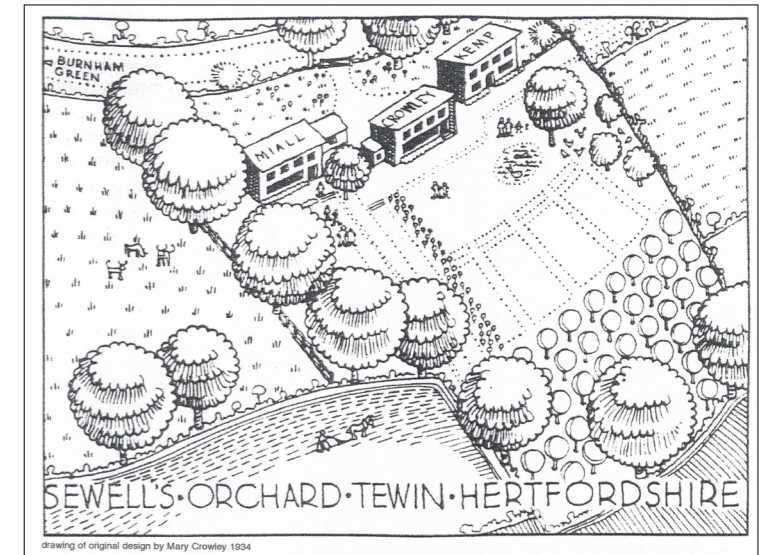

Fig. 8. Line drawing by Mary Crowley showing bird's eye view of a group of three houses at Sewell's Orchard, Tewin. Courtesy of Dennis Sharp Archive.

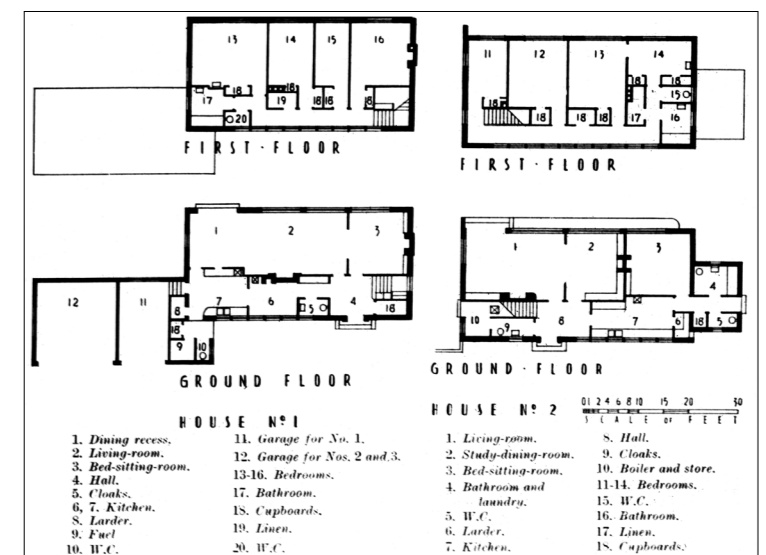

Fig. 9. "Houses At Tewin, Herts, Architect: Mary Crowley A.R.I.B.A.," *The Architect & Building News*, June 26, 1936, 388. Courtesy of Architectural Association Photo Library.

architect to the Miners Welfare Commission and was responsible for the innovative design of the pithead baths, and a third house for another Quaker family, the Mialls (Fig. 7).<sup>23</sup>

The three houses in Tewin are radically different to anything else in the area. The mono-pitch buff brick structures look deceptively simple. The influence on the design was Scandinavian and drew on the seminal AA trip from 1930.<sup>24</sup> Every detail was carefully thought through especially in relation to the services and the control of sun, light and air. The upper floor bathrooms are grouped together with a concrete floor to cope with any leaks or future failures; the ironmongery on the windows allow for the full extent of the windows to be opened without any dividing frames and all the rooms have natural controllable air vents. The internal arrangement on the ground floor with sliding doors creates a flexible space which can be used for intimate dining or open plan parties. The shared gardens maintained a sense of the open countryside and a pond was designed to store rainwater. A simple return on the south facing façade gives each house a sense of enclosure and privacy (Fig. 7). Completed in 1936, the Sewell Orchard houses were included in an exhibition at the Building Centre<sup>25</sup> and published alongside houses by other great Modern Movement architects such as Breuer, Yorke, Goldfinger, Lubetkin, Lescaze, Chermayeff, and others in F.R.S. Yorke's book *The Modern House in England* published in 1937. This was a remarkable achievement and testament to her talent as an architect (Figs. 8 and 9).

In the same period Mary worked with Ernö Goldfinger on several projects including his own house which was part of a terrace of three units in Willow Road, Hampstead (London NW3). Goldfinger had moved to London in 1934 after marrying an English artist he met in Paris, Ursulla Blackwell, (of the Crosse and Blackwell food group) and he had offices in Bedford Square near the AA.<sup>26</sup>

The two housing projects are very different. Goldfinger's houses are a split level terrace of red brick faced town houses with a spiral staircase linking the multi levels whilst the Tewin houses are a group of modern villas in the countryside on one and a half acres of land. It is difficult to see what Mary contributed to the Goldfinger terrace but Sewell Orchard was entirely under her control and in her interviews she also acknowledges the help of John Brandon-Jones and Cecil Kemp.<sup>27</sup> She collaborated on projects with Brandon-Jones and other students who studied with her at the AA, including Judith Ledebor.<sup>28</sup>

23 Bill Miall, *Memoirs*, [http://prism.bham.ac.uk/~miallrc/private/WEM\\_memoirs.pdf](http://prism.bham.ac.uk/~miallrc/private/WEM_memoirs.pdf) (accessed November 3, 2015).

24 Brodie talking to Mary Medd, September 7, 1998, National Life Story Collection: Architects' Lives, British Library C467/29, Medd, Mary, Part 3 of 11, <http://sounds.bl.uk/Oral-history/Architects-Lives/021M-C0467X0029XX-0003V0> (accessed July 6, 2017).

25 Catherine Burke, *A Life in Education*, (London: Ashgate, 2013), 69.

26 Design Museum, "ERNÖ GOLDFINGER Architect (1902–1987) Designing Modern Britain" (2006) <http://design.designmuseum.org/design/erno-goldfinger?print=1> (accessed January 4, 2016).

27 Brodie, Part 3 of 11.

28 Leonard Marsh, *Mary Medd Architect 1907–2005* (Kent: Meadow Publications, 2013), 4.

## School Building Design

Mary collaborated with Goldfinger on a series of projects for the French toy makers Abbats and a project for a prototype prefabricated expanding nursery school commissioned by the Nursery Schools Association in 1934. A sketch of the design is held by the RIBA Drawings and Archive Collections.<sup>29</sup> She went on to design a nursery school at Kensal House, the innovative housing project by Maxwell Fry (Fig. 10). Kensal House was completed in 1937 and financed by the Gas Light and Coke Company for re-housing slum dwellers. The dramatic curve of the nursery school creates a dynamic geometry and sense of place. There are many similarities with the prototype she had designed a few years earlier for the Nursery Schools Association, particularly the use of top lights and sliding folding doors that merge inside and outside spaces. Mary was also involved in Goldfinger's *The Child Exhibit* at the 1937 British Pavilion at the *Exposition Internationale des Arts et Techniques dans la Vie Moderne* designed by Oliver Hill under Frank Pick. Hill was a contemporary AA student who had also gone on the AA trip to the Stockholm Exhibition in 1930.<sup>30</sup>

Between 1938–40 just before the onset of Second World War, Mary and another contemporary student, Anne Parker, worked with Goldfinger on designs for evacuation, school, and holiday camps.<sup>31</sup> In 1940 she collaborated with Justin Blanco White (another ex-AA student) and Goldfinger on prefabricated industrial housing design run by the RIBA.<sup>32</sup>



Fig. 10. Nursery at Kensal House designed by Mary Crowley. Courtesy of Architectural Association Photo Library.

29 Juliet Kinchin and Aidan O'Connor, *Century of the Child: Growing by Design, 1900–2000*, (New York: MOMA, 2012).

30 "The A.A Visit to Sweden and Denmark," *The AA Journal* 46, no. 522 (August 1930), 104–6.

31 *Architects & Building News*, October 27, 1939, 88–9, and *Architects & Building News*, March 22, 1940, 288.

32 R.I.B.A., *Industrial housing in wartime: Results of a competition organised by the Royal Institute of British Architects* (London: RIBA, 1940).

## Hertfordshire County Council

1941 was a turning point for Mary when John Newson, the Chief Education Officer at Hertfordshire, offered her a job to work in the Hertfordshire County Council's Education Department.<sup>33</sup> There was an urgent need to help schools make arrangements for the mandatory requirement to feed school children – something her father had campaigned for. She worked with Paul Mauger on the project which mainly focused on providing facilities for cooking in small village schools. This also gave Mary an opportunity to speak to teachers about education ideas. She kept up with the ideas of Henry Morris on the village schools in Cambridgeshire through John Newsom and her father.<sup>34</sup>

The 1944 Education Act radically changed the education system for secondary school in England and made all schooling free for all pupils and raised the school leaving age to 15. The new Act made it a duty of local education authorities to secure the provision of primary and secondary schools:

and the schools available for an area shall not be deemed to be sufficient unless they are sufficient in number, character, and equipment to afford for all pupils opportunities for education offering such variety of instruction and training as may be desirable in view of their different ages, abilities, and aptitudes, and of the different periods for which they may be expected to remain at school, including practical instruction and training appropriate to their respective needs.<sup>35</sup>

The pressure to build new schools in a war-torn Britain where there was a shortage of materials required great ingenuity and creativity to deliver large numbers of buildings quickly and economically.

In 1945 Hertfordshire County Council appointed its first ever County Architect, C.H. Aslin. Aslin established the Hertfordshire County Architect's Department in 1946 with Stirrat Johnson-Marshall as his deputy and a team of architects including Mary and David Medd. When Mary joined the Hertfordshire Architect's Department she was nearly forty years of age, single and the only professional female architect on the staff list. Her experience of pre-fabricated building construction and her in depth knowledge of education and school design internationally made her an invaluable member of the team that was already aspiring to build fifteen schools within two years of being established.<sup>36</sup> The first three schools that were designed by the team that Mary and her future husband David Medd were part of were Essenden School (120 children), Cheshunt School (200 juniors) and Croxley Green School (320 children).<sup>37</sup>

Mary's most significant work on schools, which was to have national and international impact, developed after she was 40 years of age and in partnership with her husband David Medd. The

couple married in 1949 and both moved from Hertfordshire County Architect's Department to the newly formed Architects and Building Branch (A&BB) headed up by Johnson-Marshall who was the deputy County Architect in Hertfordshire. The Medds wrote many of the *Building Bulletins* that became the standard references and set the standards for school design all over the world including the Ministry of Education *Building Bulletin 1* which was issued in the first year (1949).<sup>38</sup> The couple worked so closely together that it is difficult to single out Mary's contribution.

From the very start of her professional career Mary was a Modernist focused on the welfare of children. Her Quaker upbringing and her father's involvement in founding Letchworth and Welwyn Garden Cities meant that in her formative years, Mary was surrounded by people with vision and ideas about social justice and equality. Ideas about space, form and prefabrication evolved from what she saw and learnt on student trips especially the famous Architectural Association student trip to the Stockholm Exhibition in 1930. Mary developed her knowledge and hands-on expertise of prefabrication and school building as a member of the Hertfordshire Architects Department. This early experience enabled Mary to pursue an international and celebrated career in school design.

<sup>33</sup> Brodie, Part 3 of 11.

<sup>34</sup> Brodie, Part 5 of 11.

<sup>35</sup> Great Britain, *Education Act 1944*: 7&8 Geo Ch 31 (London: HMSO, 1944), 5.

<sup>36</sup> "Architectural Pre-View, The Hertfordshire Architect's Department," *Architectural Review* (February 1947), 63–6.

<sup>37</sup> Ibid.

<sup>38</sup> Geraint Franklin, 'Built-in variety': *David and Mary Medd and the Child Centred Primary School, 1944–80*, *Architectural History* 55 (2012), 321–367.

**Yasmin Shariff**

**Dennis Sharp Architects**



Yasmin Shariff is director of Dennis Sharp Architects, a practice with close associations with DoCoMoMo. She has worked on many Modern Movement buildings including Mary Crowley's Kemp house in Tewin. She was a senior lecturer at the University of Westminster for over 15 years and a trustee and Honorary Secretary of the RIBA and the Architectural Association. Currently she is chair of the steering group AA XX 100, set up to mark the centenary of women at the Architectural Association in 2017 and serve as a catalyst for a wider discussion of women in architecture.

E-mail: [yshariff@sharparchitects.co.uk](mailto:yshariff@sharparchitects.co.uk)



## Women Architects in the Shadow: Aino Marsio-Aalto

Aino Marsio-Aalto, one of the most important Finnish architects of the beginning of the 20th century, was Alvar Aalto's professional and personal partner from the start of his career until her death in 1949. But like other female partners of renowned architects, Marsio-Aalto worked behind the scenes. Her work has never been valued despite the fact that she was co-author of Alvar Aalto's projects, designed independently and led an international design company (ARTEK). The scope of her work encompassed architecture, interior projects and industrial design, with interest in residential architecture, minimum habitation projects, furniture and glass design.

Analysis of her work showed adherence to rationalistic principles of the Modern Movement, with emphasis on functional and practical issues, use of natural materials and mass-production. She created projects with an exquisite sensitivity to detail, colour, materials and textures. Aino Marsio-Aalto focused on small-scale projects to improve everyday life.

This paper highlights the work of the architect Aino Marsio-Aalto, who has been hidden behind the shadow of her husband. All these female pioneers of the beginning of the 20th century are the workhorses of the emancipation of women, and it is necessary that their personal stories uncovered to give them their due recognition.

Keywords: women architects, Aino Marsio-Aalto, Modern Movement, rationalism, Finland, Alvar Aalto

### Introduction

Aino Marsio-Aalto (Fig. 1) was one of the most important Finnish architects of the beginning of the twentieth century. She was the professional and personal partner of Alvar Aalto from almost the beginning of their professional career in 1920 until her death in 1949. However, her work has not been extensively studied in spite of her being a key figure in modern Finnish architecture and also a key figure in the work of her husband.

In the many studies about Alvar Aalto, limited credit has been awarded to Aino Marsio-Aalto and few written articles that analyse her work can be found.<sup>1</sup> The aim of this paper is to study and bring to light the professional career of Aino Marsio-Aalto, to understand and appreciate her architecture and design and to publicise and value her work placing it justifiably within the history of modern art, as a matter of historical justice. In the case of Aino Marsio-Aalto, the tandem with Alvar Aalto was not only personal but also professional, working with him as a collaborator, co-author and independent designer. She worked on architecture and interior design projects, preferring residential architecture, small dwellings, interiors and the design of furniture and everyday objects.

Aino Marsio-Aalto was always kept in the background, and her work in collaboration with her partner has not been clearly defined or fairly acknowledged until recently. The same thing has happened with other known professional couples of the twentieth century. After analysing the personal history of the great



Fig. 1. Aino Marsio-Aalto drawing at her desk in the office of Jyväskylä, around 1924.

Photo: Alvar Aalto Estate/Alvar Aalto Museum

<sup>1</sup> This article is based on the introduction to a study dedicated to one of these female architects, but acknowledging also the great number of other women forgotten by history. Heiki Alanen, "Preface," in Ulla Kinnunen (ed.), *Aino Aalto* (Helsinki: Alvar Aalto Foundation, Alvar Aalto Museum, 2004), 7.

architects of the past century we find that many had a female architect at their side, both professionally and personally. This is the case of the group, The Four, formed by two pairs of architects, Charles Mackintosh and his wife Margaret MacDonald and Herbert McNair and his wife Frances MacDonald. The *Deutscher Werkbund* had several architect couples, such as Hermann Muthesius and his wife, Anna Muthesius, Hans Poelzig and Marlene Poelzig, and Mies Van Der Rohe and Lilly Reich, who was his professional and personal partner before he immigrated to the United States. The list also includes Auguste Perret and his wife Karola Bloch, Le Corbusier and Charlotte Perriand, and Louis Kahn and various lovers who were architects like Anne Tyng and Harriet Pattinson. Ernst May's professional partner was Margarete Schutte-Lihotzky. Heikki Siren and Kaija Siren were personal and professional partners. In the Netherlands, Jan Frederik Staal was the partner of Margaret Kropholler, Mart Stam was married to Lotte Stam-Beese, and the architect Johan Niegeman was married to Bé Niegeman-Brand.

Alvar Aalto has always been considered a genius and a charismatic architect. However, this has not taken into account important professional collaborators and that he never directed the studio alone. In particular, two female architects accompanied him during his life, first Aino Marsio-Aalto and after her death, Elissa Mäkkiniemi. This implies that work attributed solely to Alvar Aalto should take into account his professional partners, who were a great influence in the practice.

It is well known that Aino Marsio-Aalto co-directed the office with her husband, taking responsibility for the clients, employees and economical and family issues. During Alvar Aalto's frequent foreign journeys, Marsio was responsible for the office and all the projects.<sup>2</sup> 'However, she never appeared in the foreground or admitted what had really been designed by her. She was always at work behind the scenes'.<sup>3</sup>

## Biography

For a better knowledge of Aino Marsio-Aalto it is important to study her biography to understand her influences and shed more light upon her work.

She was born in Helsinki in January 1894 to a proletarian family and was brought up in a housing complex for railway families. According to Suominen-Kokkonen her natural modesty, her interest for minimalism and preference for simple design is due to the atmosphere in which she grew up.<sup>4</sup> In 1913 she began to study architecture at the Polytechnic University of Helsinki. 'At that time there was



Fig. 2. Aino Marsio and Alvar Aalto in the Finnish Pavilion at the New Yorks World Fair, 1939. Photo: Alvar Aalto Museum

no professional separation between architects, interior and furniture designers, so her studies covered these subjects'.<sup>5</sup> Whilst studying she worked as a carpenter and building apprentice. This experience strongly influenced her later work and her work as director of Artek.

In 1919 the Female Finnish Architects Association *Tumstocken* was founded, which in 1942 evolved into *Architecta*. Marsio was a member from the beginning.

When she finished her university studies in 1920, she started to work for Oiva Kallio in Helsinki. In 1923 she collaborated in the studio of the architect Gunnar A. Wahlroos in Jyväskylä. A year later in 1924, she moved to the studio of Alvar Aalto in the same city. Six months later they were married. From that moment on they worked as a team, with Marsio acting as co-director of the office. In 1927 the practice moved to Turku when they won the competition to build the Agricultural Co-operative in the Southeast of Finland. In 1933 the studio relocated to

Helsinki where it remained for the rest of its existence.

In 1935 together with Alvar Aalto, the Gullichsen couple and Niels-Gustav Hahl, Marsio created Artek (Art & Technology) in Helsinki.<sup>6</sup> The company was conceived to develop objects for the domestic industry. From this moment onwards, Marsio-Aalto's principal interest was the business, first as the creative director, then as the general director, after the death of Hahl in 1941. She continued to lead the company, alongside many other projects, until her death from cancer in Helsinki in 1949 at the age of 55 (Fig. 2).

## Analysis of Her Work

Aino Marsio-Aalto was an architect who remained almost exclusively in the shadow of her husband, and of whom we know very little either of her work or of her person. Very few of her written works exist so the most important primary sources are her projects. However the work of Aino Marsio-Aalto is closely tied to that of her husband, and we must also bear in mind that the creative process

2 Mia Hipeli, "Aino Marsio-Aalto architect," in Kinnunen (ed.), *Aino Aalto*, 59.

3 Sigfried Giedion, *Space, Time and Architecture: The Growth of a New Tradition* (Cambridge: Harvard University Press), 667.

4 Arne Heponranta, "About Aino Marsio-Aalto," in Kinnunen (ed.), *Aino Aalto*, 17.

5 Kaarina Mikonranta, "Aino Marsio-Aalto Interior and Furniture Designer," in Kinnunen (ed.), *Aino Aalto*, 110.

6 "Artek (Company)," [https://en.wikipedia.org/wiki/Artek\\_\(company\)](https://en.wikipedia.org/wiki/Artek_(company)), (accessed January 27, 2017).

is usually the result of several imaginative strengths, which complicates the task of discovering the independent roles played by each architect.

To understand the work of Aino Marsio-Aalto it is fundamental to analyse the work that can be credited to her without joint authorship. The objective is to highlight Aino Marsio-Aalto as an independent architect and not to analyse her work in relation to the one of her husband, as has been done before, thus keeping her still in the shadow.

She was interested in improving an individual's everyday life, so her main focus was the design of small and domestic scale projects that helped to facilitate people's daily routines. Consequently, in this paper some of these will be studied.

For the clarification of the authorship of the designs it is necessary to examine the proof. In the case of utilitarian objects and furniture, the authorship is based on the exhibition named *Alvar & Aino Aalto. Design* carried out in Germany in 2004. For the design of kitchens and interiors, this justification is based on the study and catalogue of all the drawings of the studio of Alvar Aalto, between 1924 and 1939, in which we find the signature of Aino Marsio-Aalto.

Aino Marsio-Aalto was especially interested in questions related to the ideals of the Modern Movement like the practicality of objects, geometric shapes, standardization and universal timeless design.<sup>7</sup> She was concerned with questions of economic, serial production, storing and stacking, and the use of durable and economical materials. This led her to design objects without an aesthetic presumption. Aino Marsio-Aalto could be considered as the more rational element of the couple.

### Design of Glass Utensils. Competition Karhula-littala: Series Bølgeblick, 1932

In 1932 the Karhula-littala factory organised a competition for the design of glass tableware (Fig. 3). Aino Marsio-Aalto won second prize with her Bølgeblick series (a view of waves), which consisted of a jug, cups, dishes, plates, a sugar bowl and a milk jug. The range went into mass production in 1932. Later a collection of glasses, vases and bowls was added. This series became very popular, and was exhibited in 1933 in London, at the Fortnum & Mason department store, and in 1936 at the Milan Triennale where it won the golden prize.<sup>8</sup> The Bølgeblick series is still in demand and being produced and imitated today.

The objects designed by Marsio had a simple shape, with no aesthetic boasting, according to the

7 Timo Keinänen, "Alvar and Aino Aalto as glass designers," in Pirkko Tuukannen (ed.), *Alvar Aalto Designer* (Helsinki: Alvar Aalto Foundation, Alvar Aalto Museum, 2002), 135.

8 Ibid., 135.



Fig. 3. Bølgeblick Series.  
Photo: Majja Holma,  
Alvar Aalto Museum

Modern Movement statements of Le Corbusier in which 'objects are just tools, pretty tools' that 'need to fulfil a special aim'.<sup>9</sup> As Adolf Loos said in 1910, design has nothing to do with personal taste but must answer practical necessities.<sup>10</sup>

The design of the collection is united to the production methods and the materials used. Rings were introduced for practical reasons as they helped to hide irregularities in the inexpensive pressed glass. This type of glass was much cheaper than blown or strained glass and, mass production was automated. All the objects could be stacked, thus saving space and adapting to the minimum kitchen and housing standards, which were being studied at the time and were of great interest to Aino Marsio-Aalto.

The design of this series could be summarised in the ideas of Le Corbusier about the making of useful objects: they had to be above all perfect, precise, efficient, and inexpensive tools.<sup>11</sup> Eighty years later, they are still modern and can be found in any of our households. This is exactly what a designer at the beginning of the 20th century aimed for, a timeless, universal design for the general use of society.

9 Le Corbusier, "Argument," in Le Corbusier, *The Decorative Art of Today* (London: The Architectural Press, 1987), 23; Le Corbusier, "Ripolin Law," in Le Corbusier, *The Decorative Art*, 18.

10 Adolf Loos, "Architecture," in Panayotis Tournikiotis, *Adolf Loos* (Princeton Architectural Press 2002).

11 Le Corbusier, "The Decorative Art of Today," in Le Corbusier, *The Decorative Art*, 84.

## Furniture Design

### Stool for the Tuberculosis Sanatorium, Paimio, 1929–1932

On winning the competition to design the Tuberculosis Sanatorium in the southeast of Finland in 1929 (Fig. 4), Aino and Alvar Aalto were contracted for the complete design of the hospital complex. This was a dream for them; it was their first opportunity to carry out their philosophy of global design. Alvar Aalto, in 1925, spoke for the first time of one ambience that would be created when the architect takes charge of the complete building and the interiors, where each detail had a special importance.<sup>12</sup>

Aino and Alvar Aalto centred all their design on the comfort and well-being of the patients. Their proposal considered that they would spend most part of the day lying in the sun or in bed. So they paid special attention to the design of the beds and loungers, as well as all the elements in the rooms. One of these objects was the stool designed by Aino Marsio-Aalto in 1932, for the hospital. It was a three-legged tubular stool with steel lacquered legs and a circular seat of lacquered wood. The tubular structures of the legs were finished with a circular tube joining them so they could be easily stacked and occupy very little space. This stool is a clear example of the purest International Style in furniture design which always created durable objects, easy to clean and cheap without unnecessary ornamentation, with regular shapes, metal structure, stackable and close to the geometric and estereometric elementarism as displayed by Walter Curt Behrendt.<sup>13</sup> The stool is light for the patients to move easily. Made in neutral colours, the part in contact with the body is smooth and warm. All of these details show the designer's great interest in the practicality of the object.

The stool, together with two armchairs –41 and 42– designed by Alvar Aalto for the hospital, formed part of a programme of modern furniture launched in 1932, after being shown in the Scandinavian Housing Fair in Helsinki in the Standard Furniture section.<sup>14</sup> This furniture would be produced and manufactured by Finnish manufacturers, and it is still being made today by the Artek company.<sup>15</sup> All the furniture designed by



Fig. 4. The Paimio stool in different finishing's. Photo: Martti Kapanen, Alvar Aalto Museum

the Aaltos during these years and especially those produced for the hospital of Paimio displayed in great measure the ideals of the Modern Movement.

## Kitchen Design

### 'Minimum Kitchen' of the Minimum Apartment Exhibition in the Finnish Society of Art and Craft Fair, Helsinki, 1930

For the Minimum Apartment Exhibition in the 'Finnish Society of Art and Craft Fair' that took place in Helsinki in 1930, the Aaltos designed a modern minimum home comprised of living/dining room, kitchen and two bedrooms. Aino Marsio-Aalto designed the kitchen and its different utensils, a table and a sideboard for the dining room and curtains for the bedroom (Fig. 5). During this period Aino and Alvar Aalto's ideas in design in the domestic space were influenced by the social transformation and the new role of women in society. Alvar Aalto displayed his ideas about this topic in 1930:

I am referring to the complete transformation of the role played by women nowadays. Their independence and emancipation from a submissive position to a complete comradeship, as much in the work as at home involves completely new requirements in the design of the home. Woman's independence leads to radically new requirements in living commodities such as easy cleaning, weight of the objects and the mechanical uses of the fixtures.<sup>16</sup>

The most innovative element of the apartment was the *Minimum Kitchen* that was greatly influenced by the practical ideas of Margarete Schütte-Lihotzky, who created the *Frankfurter Küche* (Frankfurt Kitchen) in



Fig. 5. *Minimum Kitchen* of the Minimum Apartment Exhibition in the Finnish Society of Art and Craft Fair, 1930, Taidehalli, Helsinki. Photo: Heinrich Iffland, Alvar Aalto Museum

<sup>12</sup> Kaarina Mikoranta, "Alvar Aalto: Master of Variation," in Pirkko Tuukannen (ed.), *Alvar Aalto Designer* (Helsinki: Alvar Aalto Foundation, Alvar Aalto Museum, 2002), 75.

<sup>13</sup> Kaarina Mikoranta, "Aino Marsio-Aalto: Interior and Furniture Designer," in Kinnunen (ed.), *Aino Aalto*, 116; Walter Curt Behrendt, *Modern Building: Its Nature, Problems, and Forms* (New York: Harcourt Brace & Co., 1937).

<sup>14</sup> Thomas Kellein, "Aino and Alvar Aalto's Hospital rooms," in *Alvar & Aino Aalto: Design*, (Ostfildern-Ruit: Hatje Cantz Verlag, 2005), 57.

<sup>15</sup> Richard Weston, *Alvar Aalto* (London: Phaidon Press Ltd, 2007), 260.

<sup>16</sup> Alvar Aalto, "El problema de la vivienda," in Alvar Aalto and Goran Schildt, *De palabra y por escrito* (El Escorial: El Croquis, 2000), 113 and 115.

1926. Ideas like efficiency, organisation, modulation, simple cleaning, reduced space, storage and resistant and continued surfaces. Much influenced by the ideas of the American engineer Frederick Winslow Taylor and his Industrial Efficiency Movement, Schütte-Lihotzky was able to create a laboratory for the modern woman, and by rationalising the space she helped to save time.

The great novelty of the *Minimum Kitchen* in comparison with the *Frankfurter Küche* is that the height of the countertop is set at the height of a table, this means that all the elements were at an ideal height for working while sitting on a chair or stool thus making life easier and more comfortable for the 1930s housewife. The kitchen was small and rectangular, approximately 3 x 2 m, separated from the living room by a sideboard.<sup>17</sup> It contained two working surfaces; a long counter and a kitchen stove. On the side of the counter, we find a continued surface, long and easy to clean. The material of the countertop also runs along the length of the wall to a height of 30 cm, eliminating joints and creating a simple design. On the counter was a stainless steel kitchen sink, designed by Aino Marsio-Aalto, with a sliding wooden lid to cover the sink and provide more workspace. Next to the kitchen sink and sharing the same tap, there was another sink for washing clothes. Below the second sink was a rubbish bin on wheels with a removable lid, made of metal and easy to clean. Below the worktop there were four cupboard modules, one of them with drawers. Any type of utensil that did not fit into the cupboards was hanging on the walls. In this way, it was a neat space with everything in its place as if it was a laboratory, thanks also to the modulation of every element.

The kitchens designed by Aino Marsio-Aalto and Margarete Schütte-Lihotzky in the 1920s evolutionized the world of kitchen design, setting the basis for the present day kitchens. They created extremely practical kitchens in which everything down to the last detail was thought out, therefore making the work of women who were beginning to enter the labour market much easier, and also helping with their emancipation. With the compact modulated kitchens, time and space was saved and domestic life moved into the background, taking women out of the place where they had historically been confined.

## Interior Design

### Competition for the Finnish Pavilion at the New York World's Fair, 1938

Aino Marsio-Aalto submitted a proposal –USA 39– for the competition of the Finnish Pavilion at the 1939 World Fair of New York (Fig. 6).

At the same time Alvar Aalto presented two other proposals *Maa, Kansa, Tjyo, Tulos* (Country, People, Work, Product) and *Kas kuusen latvassa oravalla* (The squirrel has a nest in the spruce tree's top).

<sup>17</sup> Kaarina Mikonranta, 'Aino Marsio-Aalto Interior and Furniture Designer,' in Kinnunen (ed.), *Aino Aalto*, 118.

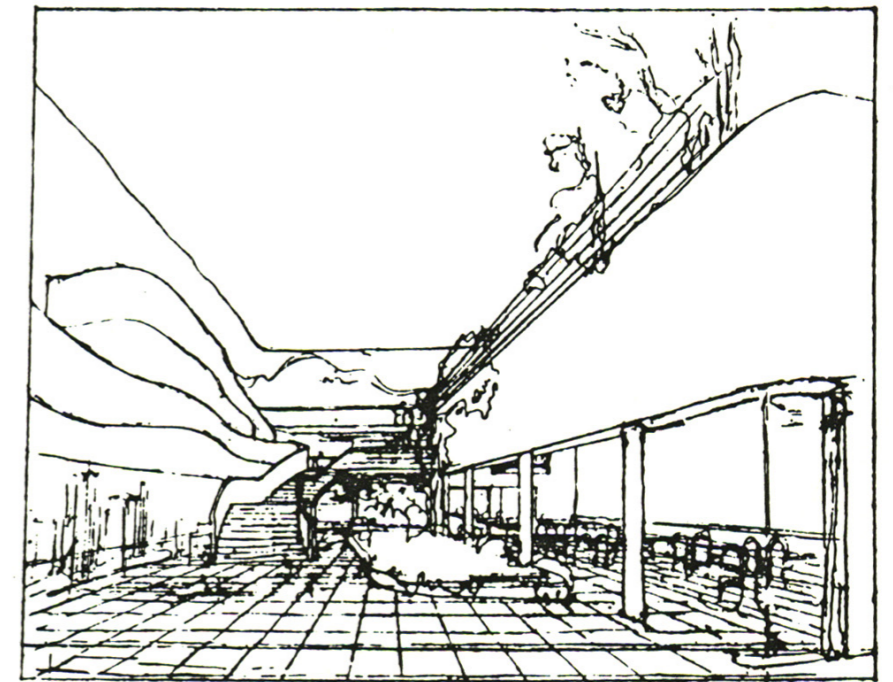

Fig. 6. Interior perspective of Aino Marsio-Aalto's proposal for the competition of the Finnish Pavilion in New York World's Fair, 1938. Photo: Alvar Aalto Museum

Aalto won the first and second prize while Marsio came in third.

The Finnish pavilion had strict design restrictions, because Finland could only afford a cubicle in a shared pavilion with other countries. Firstly it did not have an outside elevation; secondly the exterior form was fixed. Thirdly, the volume was determined and fourthly, and most important, the project was limited to an interior design that was supposed to impress a public overwhelmed by the great number of pavilions of the Fair. The trigger for the couple to present several proposals was the chance to be able to implement some of the ideas that were left pending in the design of Villa Mairea, the couple's most famous single-family house.

A fourth project designed by Aino and Alvar Aalto was finally built combining all of the proposals submitted.<sup>18</sup> The project that was finally carried out is one of the most analysed works of the practice, and because it is difficult to distinguish the individual input of each of the architects, we will study the proposal that Aino Marsio-Aalto presented independently. The project had to deal with a long and tall space (four stories high) so Aino Marsio-Aalto's proposal tried to break this pronounced long and narrow volume by creating two converging longitudinal façades in order to reduce the tunnel effect of the space. These two elevations had different architectonic treatments; one had two undulating balconies that break the high interior façade and provide dynamism and excitement, and the opposite side had a long linear terrace acting as counterweight to the facing elevation.

<sup>18</sup> Göran Schildt, "Finnish pavilion at the World's Fair in New York," in Alexander Tzonis, *The Architectural Drawings of Alvar Aalto. 1917–1939* (New York: Garland Pub., 1994), 170. Göran Schildt, "Finnish pavilion at the New York World's Fair 1939," Alvar Aalto Museum, <http://file.alvaraalto.fi/>, accessed August, 2015.

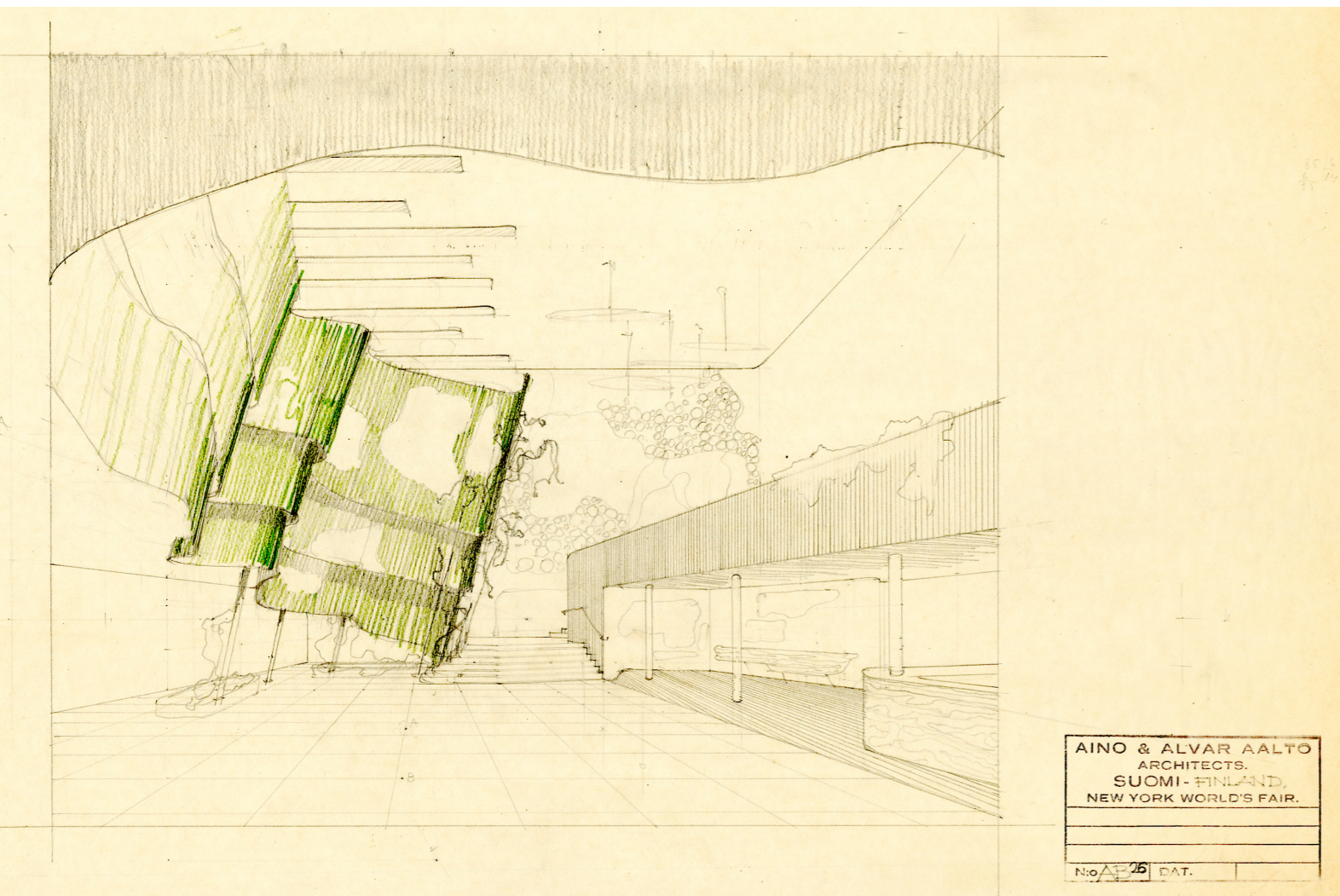

Fig. 7. Perspective of the final Project, 1939. Photo: Alvar Aalto Museum

The two converging facades created an artificial valley, which made you forget that this was an interior prismatic volume. This central void was the most interesting spatial point of the pavilion. The balconies were all connected creating a spatial continuity around the inner space; they generated an ascending walk towards the top terrace like a corbusian *promenade architecturale*. On the ground floor we find the access to the pavilion and in the centre of the main space there are two important elements: a garden with an irregular shape that broke the long room and brought nature to the interior (reminiscent of a Finnish forest), and an Italian ramp-staircase located at the end of the space that connected with the first floor balconies. This pavilion was an object of great dimensions, an important sculptural object that also shortened the length of the space.

The first floor was composed of two balconies –one linear and the other undulating– that met on a large landing where the staircase ended. The undulating balcony on the first floor contained the main exhibition space of the pavilion, where interesting viewpoints were created. The linear terrace was closed and used as a projection room, thanks to the trapezoidal shape of the floor plan.

The second floor had the smallest footprint; here the undulating balcony disappeared and only the linear terrace remained. Stylistically, this gallery was designed following the Modern Movement principles. It was a linear platform elevated on *pilotis*, rendered presumably in white, with rounded edges and a tubular horizontal balustrade reminiscent of some emblematic buildings from the International Style, like the houses for the Bauhaus masters of Walter Gropius from 1925–6 or the *Villa Savoye* of Le Corbusier from 1929. This mezzanine had a large space that mainly acted as a top balcony where one could admire the whole pavilion. An important feature was the *jardinière* on the second floor that was connected to the lower floor garden.

If the perspective sketched by Aino Marsio-Aalto is compared to a photo of the final project we can see that they were extremely similar (Fig. 7). Both had a linear balcony supported on *pilotis* on the right hand side, an undulating wall on the left that brought dynamism to the space, an important central staircase and natural elements along the building reminding us of Finnish nature. The main architectonic element is the central 'inverted valley' around which everything revolves and which endeavours to transport us out of the interior space to the magnificent Finnish lakes and forests.

## Conclusions

The purpose of this paper is to cast light on the professional work of the architect Aino Marsio-Aalto, almost forgotten in the shadow of her genius husband. It is not intended to highlight the value of a female architect for the mere fact of being a woman, but as a matter of historical justice. Until recently, history has belittled or ignored the role of women in any professional environment, especially if it is technical or architectural.

Recently, in Finland some articles have been devoted to the role of Aino Marsio-Aalto as an important collaborator in the work of Alvar Aalto, however they do not approach her work individually or try to value her professional career apart from the work of her husband.<sup>19</sup> This individual approach happened for the first time in 2004 in an exhibition dedicated to Aino Marsio-Aalto at the Alvar Aalto Museum. It was the first time that her personal life and professional career was addressed separately.

Due to the limited attention that Aino Marsio-Aalto's independent professional career has received, it has not been given its deserved place in history. This is because 'in the period that is discussed it appeared to be quite common for the joint projects of architect couples and the work of their joint offices to be recorded predominantly as the achievement of one spouse, thus overshadowing the

<sup>19</sup> Renja Suominen-Kokkonen, *Aino and Alvar Aalto: A Shared Journey: Interpretations of an Everyday Modernism* (Helsinki: Alvar Aalto Foundation and Alvar Aalto Museum, 2007).

other'.<sup>20</sup> Therefore when we bring to light a compilation of her architecture and design projects we help to clarify her important figure as a Modern architect and design pioneer.

There is enough evidence that Alvar Aalto respected the work developed by his wife in and outside the office. As Giedion described, all Aalto's exhibitions and his work up to 1949 were signed 'Aino and Alvar Aalto'. It was not a gesture of chivalry<sup>21</sup> but to the fact that their marriage was a 'partnership marriage'. In Finland in the 1920s this concept was a distinct expression of the modern.<sup>22</sup> If we talk about her talent, according to Viola Markelius, Marsio was more interested in social issues and her ingenuity was deeper than Alvar's.<sup>23</sup>

Aino Marsio-Aalto was mostly focused on small scale projects in which she put all her time and interest, so as to enrich and improve the daily life of the individual in his most intimate dimension through the improvement of his close surroundings (Fig. 8). If we analyse her work, we could consider Aino Marsio-Aalto as the rational element within the couple. If we examine her pieces there is a big emphasis on utilitarian, functional, and practical issues, as well as to the use of natural materials and mass-produced objects. She created pieces and designs without a strong aesthetical display, where the needs set the aesthetics of the objects. These ideas were less evident in Alvar Aalto's work. According to her grandson, Alanen, 'Aino remained loyal to functionalist ideas and designed practical things that were carefully studied and finished throughout'.<sup>24</sup> Based on this analysis, we can deduce that during the functionalistic period of the 1930s Aalto's work was highly influenced by Aino Marsio-Aalto's ideas. The domestic scale in the buildings of Alvar Aalto might also be strongly influenced by Aino Marsio-Aalto. The detailed design of every project, from its architecture, interior design, furniture and lighting, could not be the work of one sole person but of a design team. The sensitivity and the exquisite taste of the interiors of the buildings of Alvar Alto could be the work of Aino Marsio-Aalto. Marsio's concern for detail, colour, materials and textures can be detected in the drawings that she created which were full of annotations and where everything was designed down to the smallest detail.

Marsio was defined as quiet, punctual, calm, with her feet on the ground, and a counterpart of the bohemian, singular and creative personality of her husband. But after the analysis of her work and her life, we can conclude that she was a strong, responsible and creative professional. Accordingly, she was able, in the beginning of the 20th century, to lead a company that produced furniture and consumer goods for a domestic and international market. Her strength is reflected in the fact that

aside from directing the company she led an international architecture firm, and during Alvar Aalto's frequent travels she directed the practice, the projects, and the family.

Female pioneers from the beginning of the 20th century like Aino Marsio-Aalto were the workhorses of the emancipation of women. It is more than justified that these personal stories start to be uncovered, to give them their due recognition. Moreover, if we take into account the role of women during this historical period, their value is even greater, because their professionalism implied a rebellion against society and its established rules that relegated women solely to the domestic sphere. Architects like Marsio were strong and very talented women, but due to the historical time they lived in, they were kept in the shadow of their professional partners. They worked together with men, out of necessity or by choice, to be able to carry out their professional career. Very few of them managed to succeed independently and if they did it was always as designers. What it is striking is that in most of these architect couples, particularly in the case of Aino and Alvar Aalto, the male partner appreciated, valued and acknowledged the professional role of female partners. The denial of women as professionals is more an omission to be attributed to the narrators of history.

20 Alanen, "Preface," 7.

21 Giedion, *Space, Time and Architecture*, 667.

22 Renja Suominen-Kokkonen, "The Ideal Image of the Home," in Suominen-Kokkonen, *Aino and Alvar Aalto*, 139.

23 Göran Schildt, *Alvar Aalto: His Life* (Helsinki: Alvar Aalto Museum, 2007), 276–277.

24 Alanen, "Preface," 9.

**Myriam López-Rodero**

**Escuela Técnica Superior de Arquitectura de Madrid,  
belonging to the U.P.M.**



Myriam López-Rodero is a Spanish architect, raised in Spain and the U.S. She studied architecture at the Polytechnic University of Madrid and the TU Delft in the Netherlands. Currently she is undertaking her PhD thesis studying Women in the Shadow, focusing especially on Finish architect Aino Marsio-Aalto. Her professional career began in Madrid with Burgos & Garrido Arquitectos and continues in the Netherlands for KCAP architects, DKV architecten, and ONIX architecten. In 2008, she moved to Spain to create with two partners Madland estudio. In 2013 she moved to Holland, founding her own firm to develop architecture and interior design projects. She currently teaches at the Academy of Architecture of the Hanze University of Applied Sciences in Groningen, the Netherlands.

E-mail: [info@mlopezrodero.com](mailto:info@mlopezrodero.com)

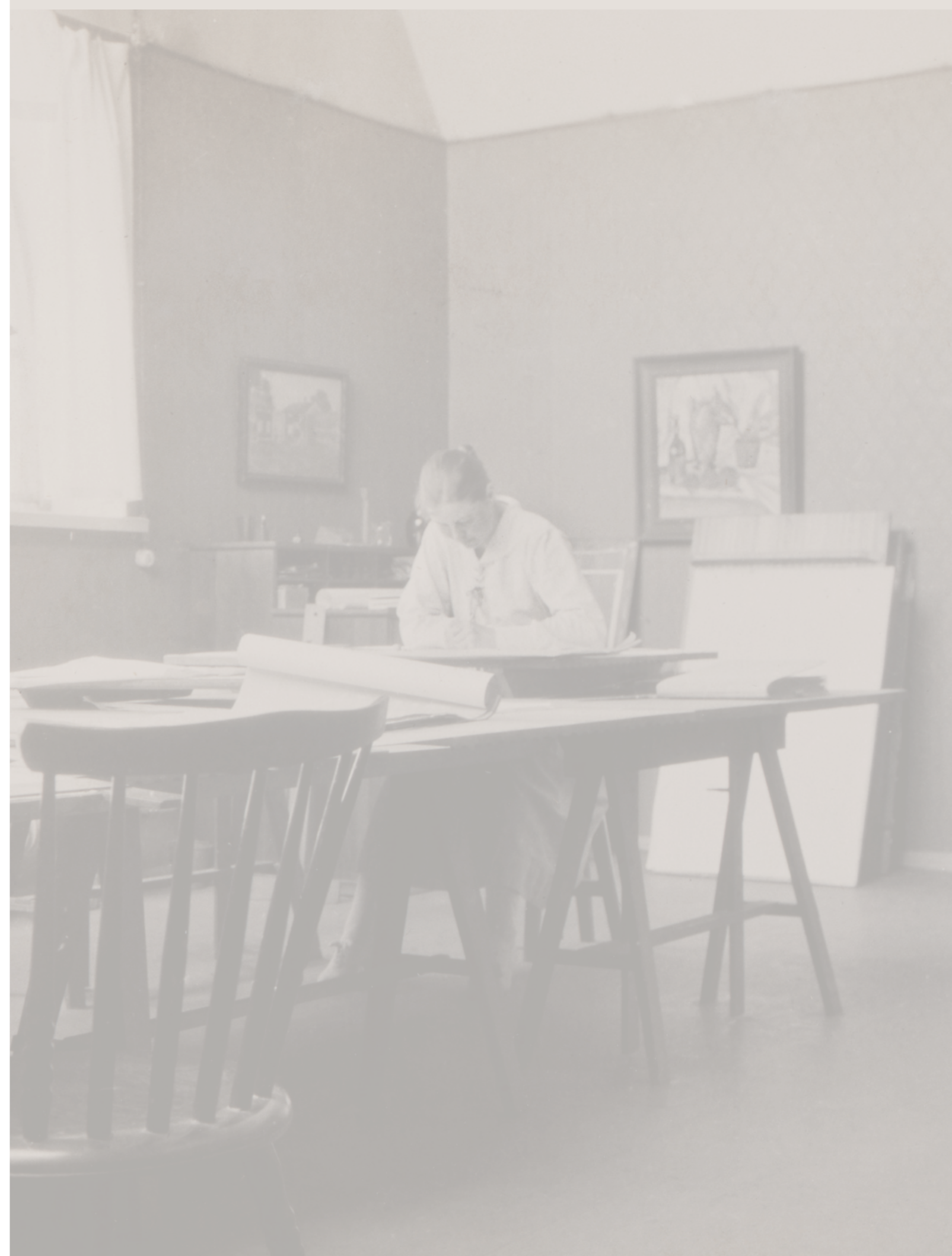

## The Case of Corona Krause: Textiles as a Spatial Apparatus

Crossing between the production of textiles intended for both bodily and spatial wrapping, Corona Krause's contribution to the terrain of modern textiles appears diversely rich. Alumna of the Bauhaus State School in Weimar, and later director of the weaving workshop at the Arts and Crafts School in Hannover, Krause belongs to the wider group of modern artists whose biographic and professional profile remains obscure, but recently cogent due to new archival acquisitions. Not only does this paper aspire to elucidate the thread of the artist's practice, stressing the need to unknot and retie modern historiographies, but it also anticipates drawing attention to the overlooked role of dress in the attentively orchestrated interior spaces produced in the early decades of the twentieth century. In so doing, it employs oral histories, archival material and observations, as well as writings of key figures of the Weaving Workshop in Weimar and sets out to provide a complex interpretation of the artist's little-known oeuvre. The contextualisation of the female body and dress within the interdisciplinary spatial production of that time, anticipates influence on a broader discussion on issues of disciplinary relevance and exchange, as well as of female representation and engagement, which was at that time valid, yet volatile.

Keywords: Bauhaus, Weaving Workshop, Corona Krause, simultaneity, modernity

Textile artworks held a pivotal role in the spatial experiments promoted by the Bauhaus State School (*Staatliches Bauhaus*) and were included in seminal interior spaces therein produced in the early years of the 1920s. In the light of the total work of art (*Gesamtkunstwerk*) concept, textiles were elevated to integral elements of interior architecture, equal to the rest of the domestic elements, namely pieces of furniture, ceramics and lighting. For the *Haus Sommerfeld* (1920–21) –the first architectural commission upon the School's establishment– for instance, Dörte Helm had created a large-format appliqué curtain,<sup>1</sup> in the dimensions of 2.10 by 2.60 meters, so as to conceal a wide wall opening in its interior (Fig. 1). The curtain echoed the geometrical patterns of the woodcarvings that Joost Schmidt had applied on the house's interior surfaces, as well as the ones that featured on its parquet floors. The interior architecture of the *Haus am Horn* (1922–23), which reached completion a few years later for the first Bauhaus exhibition in Weimar (1923), similarly incorporated site-specific textile artworks. The floor of its living room was covered by a carpet designed by Martha Erps-Breuer that aligned with the visual identity of its neighbouring fittings designed by Marcel Breuer and László Moholy-Nagy (Fig. 2). It was in the case of another space on display during the 1923 exhibition, however, that the contribution of textile design to interior architecture was expressed at its most evident.

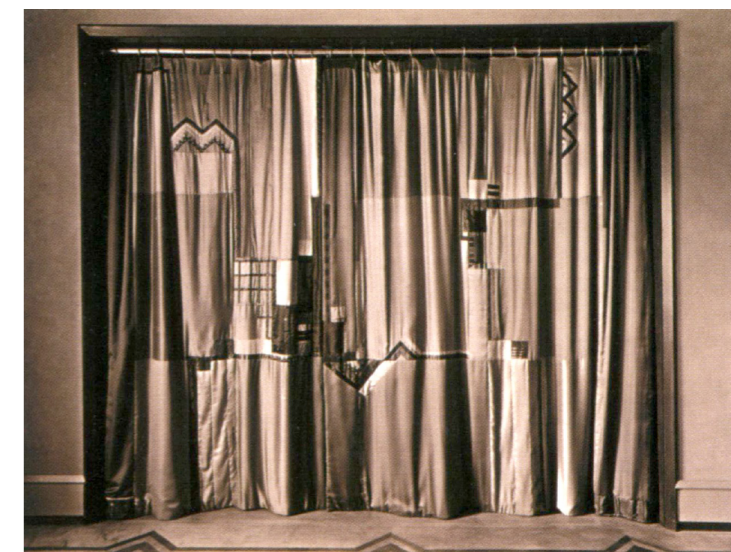

Fig. 1. Dörte Helm, Curtain with *appliqué* technique for the Haus Sommerfeld (1920–21).

Published in *Dörte Helm am Bauhaus in Weimar* (Weimar: Freundeskreis der Bauhaus-Universität Weimar, 2009), s.p., Exhibition catalogue.

<sup>1</sup> The catalogue of an exhibition on Dörte Helm at the Bauhaus-Universität Weimar (18 July – 6 September 2009), provides valuable insights into the body of her work. See Dörte Helm, *Am Bauhaus im Weimar* (Weimar: Freundeskreis der Bauhaus-Universität Weimar, 2009), Exhibition catalogue.

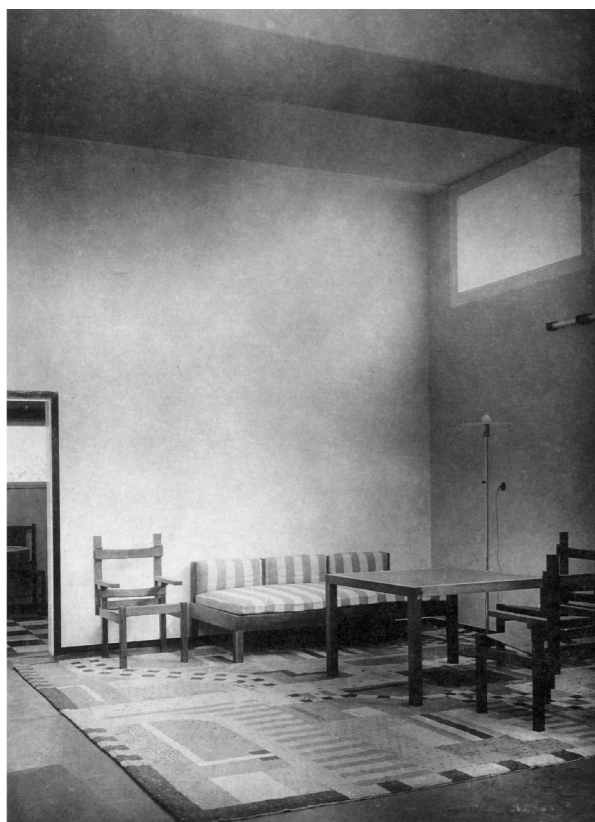

Fig. 2. Martha Erps-Breuer, Carpet for the Haus am Horn (1923). Published in Juliette Desorgues et al. (eds.), *Bauhaus: Art as Life* (London: Walther König, 2012), 89.

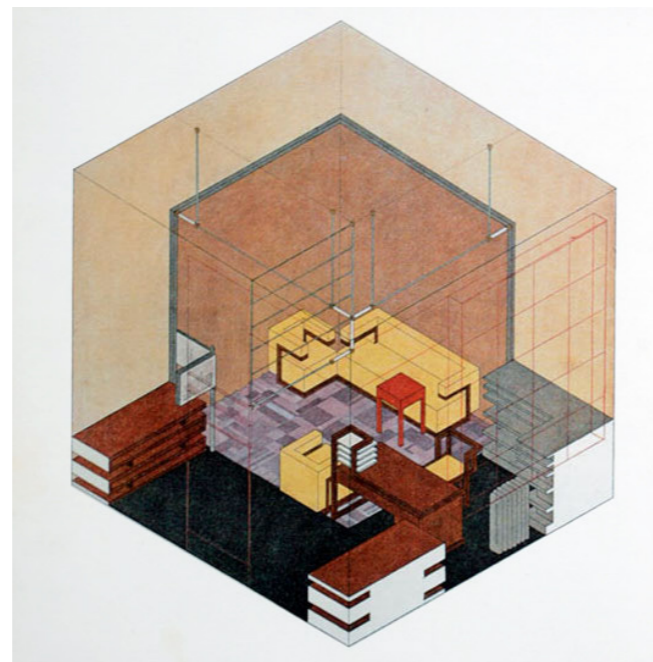

Fig. 3. Walter Gropius, The Office of the Bauhaus Director Weimar (1923). Published in Magdalena Droste and Jeannine Fiedler (eds.), *Experiment Bauhaus: Das Bauhaus-Archiv, Berlin (West) zu Gast im Bauhaus Dessau* (Berlin: Kupfergraben, 1988), 82.

Apropos the *Direktorzimmer Bauhaus* in Weimar (1923) (Fig. 3), not only did woven elements –namely the knotted-pile carpet by Gertrud Arndt and the silk wall hanging by Else Mögelin– articulate the room’s linear and spatial continuity, but, also, the diverse functional spaces were attentively ‘interwoven’,<sup>2</sup> as if both two- and three-dimensional elements had been ‘stitched’ together in an homogeneous space. The interrelation between textiles, furniture and other interior space elements could be ascribable to the visions of Walter Gropius for the ‘complete building’, as defined in his 1919 Bauhaus manifesto, in which architecture would converse with sculpture and painting. Meanwhile, its expression could, to a large extent, be attributed to the work of the Weaving Workshop. Through close collaborations with

2 ‘Even more than the furnished interiors of the *Haus am Horn*, the director’s office made all of the Workshop’s products – textiles, graphics, furniture, lighting – integral parts of a radical spatial experiment. Inspired not only by De Stijl extensions of space through linear continuities but also by Wright’s technique of weaving one space into another, the office layered both space and spatial perception through line and colour, through the suggestion of boundaries and wrapping spaces, and through functional zoning’. Barry Bergdoll and Leah Dickerman, *Bauhaus 1919–1933: Workshops for Modernity* (New York: The Museum of Modern Art, 2009), 49.

the Carpentry Workshop<sup>3</sup> and a perpetual dialogue with art and craftsmanship, the Workshop had a vivid and active presence in the majority of interior spaces produced.

It was to this environment of osmotic alliance between products of architecture, fine art and craftsmanship that Corona Krause<sup>4</sup> was introduced in Spring 1923, as a student of the preliminary course (*Vorkurs*) at the Bauhaus. Krause was born on 16 August 1906 –to a German consul, Friedrich Krause, and his wife, Isolde Morrison– in Coronata, Genoa. A textile artist, who had engaged in artisanal workshops on the craft of weaving prior to her inscription at the Bauhaus, Krause would later go on to make her own contribution to the wider map of modernist textile artworks in Germany. She was also an artist who had contributed a winning entry to a competition by the Junkers factory for aircraft upholstery designs,<sup>5</sup> who went on to initiate her own independent practice and who became largely involved in pedagogic activities – first at the Arts and Crafts School in Halle (Burg Giebichenstein Kunsthochschule) and then at the respective School in Hannover.

Aiming to shed light on the artist’s little-known artistic profile, the present article focusses on her stay at the Bauhaus, in the period between 1923 and 1925, and sets out to situate it within the wider cross-disciplinary debate of that period between interior space and textiles. It explores how her interaction with the pre-eminent figures of the School, and her involvement in its diverse activities, laid the foundation for her further creative professional practice. Consequently, it discusses selected artworks, currently found in the family archives and the collection of the *Sammlungsarchiv* at the Bauhaus Dessau Foundation (Stiftung Bauhaus Dessau), which are attributed to the artist and were created in the course of, and after, her educational stay at the Bauhaus. Emphasis is placed on a dress, which is included in the archival collection of her work and is estimated to date back to the late 1920s. As this paper considers how the dress alludes to materials and techniques promoted by the Weaving Workshop of the Bauhaus State School in Weimar, it aspires to understand the role of bodily attire in its extensive definition, within a wider context of holistic domestic environments produced by the School, as well as in reference to the artistic practices taking place at that time and, in terms of artistic production, later on as well.

3 This collaboration also led to a simultaneous approach to interior space elements such as pieces of furniture. ‘Later collaborations between the two Workshops in Dessau’, Weltge notes, ‘would result in the cohesive unity of fabric and chair and would be advertised with technical specifications including the elasticity of the material’. See Sigrid Wortmann Weltge, *Bauhaus Textiles: Women Artists and the Weaving Workshop* (New York: Thames and Hudson, 1993), 58.

4 The research project with the working title Corona Krause – Hermann “Sven” Gautel. “Le chaînon manquant” is being undertaken by the grandson of Krause, Jakob Gautel.

5 The information on Krause’s participation in the competition established by Junkers –the German aircraft and aircraft engine manufacturer based in Dessau– was provided by Jakob Gautel during our phone discussion on November 23, 2015.

### A Weaver's Formation: From the Visual to the Tactile Canvas

From April 1923 until her enrolment at the Weaving Workshop the following year, Corona Krause attended the preliminary course of the Bauhaus School in Weimar, during which she delved into experiments with watercolour, nude painting and typography, as the extent of her portfolio suggests. In that year, László Moholy-Nagy had succeeded Johannes Itten<sup>6</sup> at the helm of the course, having had significant impact on the formation of the Bauhaus weavers. Given that the succession was still recent, traces of Itten's influence on the weavers' practice were still evident. For instance, textile artworks of that period still drew upon elementary forms combined with primary colours – features that were characteristic of Itten's theory and teaching. Paul Klee also served as an influential figure for the Weaving Workshop practices in those days. Through his design theory courses, he prompted the weavers to experiment further with woven textiles that featured geometrical patterns, alongside a combination of colourful layers and stripes. A pencil sketch in Krause's portfolio – bearing the title 'Master Klee' and depicting Paul Klee's profile – reveals his informal bonds and close connection to the Bauhaus weavers and students of the School. In a broader context, the preliminary course of the Bauhaus comprised a platform of experimentation with materials, essential to the later engagement of students with weaving – one branch in a broad variety of handicrafts explored at the School.<sup>7</sup>

Among the pen drawings, watercolours and graphic works which Krause produced during the preliminary course of Moholy-Nagy, a balance study (*Gleichgewichtsstudie*) is found: it is entitled 'Floating Plastic, Illusionistic (*schwebende Plastik, illusionistisch*)' (1923) and survives through a silver gelatin print of 1955 located at the Bauhaus-Archiv in Berlin (Fig. 4). Comprising rectangular parts of solid wood and plastic that balance on a delicate spiral body, it refers to a sculptural piece which seemingly challenges gravity. Krause's limited reputation to this day could be presumably accredited to this sculptural artefact, given that László Moholy-Nagy had included it in his 1938

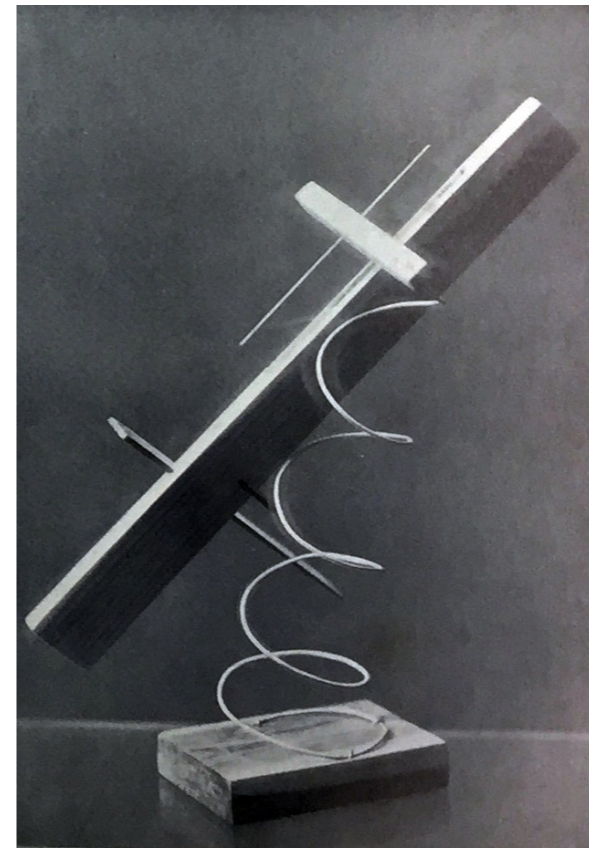

Fig. 4. Corona Krause, *Floating Plastic: Illusionistic* (1924), Photograph: Eckner, Weimar. Published in László Moholy-Nagy, *Vision in Motion* (Chicago: Theobald, 1965), 125.

book *The New Vision. From Material to Architecture*.<sup>8</sup> Arguably, the principal characteristics of this study would later be incorporated into Krause's textile artefacts, which although they had not received an equally broad attention as the 1923 study, they bore a vivid interest in the interpretation of geometry, abstractness and balance.

'Miss Korona Krause, you have been preliminarily accepted in the Workshop,' announces a letter addressed to the artist on 4 July 1924, signed by Walter Gropius. It indicates that 'admission shall be made on August; until then, you are on leave of absence.'<sup>9</sup> This document is the earliest surviving form of correspondence between Krause and the Weimar School, directed in those days by Gropius, and marks the beginning of her studentship at the Weaving Workshop, at the age of eighteen. From within a female terrain of creativity, integral to the Bauhaus State School, Krause would produce various artefacts that ranged from domestic furnishings, tablecloths, pillow cases and blankets, to women's and children's apparel.

A study in watercolour, coloured pencils and pencil on paper – dating back to 1924 – comprises a composition with circular segments and lines, while it is testament to the weaver's

6 Johannes Itten had an ongoing interest in textiles and the origins of his relationship with textile design can be traced back in the period between 1923 and 1926, a time when he founded the Ontos Workshops for handweaving, together with Gunta Stölzl. Later on, his contribution to art textile practice would be complemented by his appointment as Director of the Advanced School of Textile Art (*Höhere Fachschule für textile Flächenkunst*) located in Krefeld in 1932. See Karin Thönnissen, *Johannes Itten und die Höhere Fachschule für textile Flächenkunst in Krefeld* (Krefeld: Van Acken, 1992) and Ernest W. Uthemann (ed.), *Johannes Itten 1888–1967: Alles in einem – Alles in sein* (Ostfildern: Hatje Cantz, 2003).

7 'There were studies of materials that we could fool around with in our own studios. These were necessary in order to familiarize us with the materials of any one of the Bauhaus Workshops, for after the *Vorkurs* it was mandatory that we learn a handicraft'. Eckhard Neumann (ed.), *Bauhaus and Bauhaus People* (New York: Van Nostrand Reinhold, 1993), 41.

8 See Lutz Schöbe, "Sind Sie an Textilien interessiert?," Bauhaus Online, <http://bauhaus-online.de/magazin/artikel/sind-sie-an-textilien-interessiert>, (accessed November 29, 2015), and "Corona Krause," Bauhaus Online, <http://bauhaus-online.de/atlas/personen/corona-krause> (accessed November 29, 2015). More recently, the balance study by Corona Krause received renewed attention after the incorporation of its 1924 photographic documentation, produced by Lucia Moholy, in the exhibition *Bauhaus: Art as Life* exhibited at the Barbican Art Gallery in London (3 May – 12 August 2012). For a catalogue of the exhibits see *List of objects proposed for protection under Part 6 of the Tribunals, Courts and Enforcement Act 2007 (protection of cultural objects on loan)*, <http://www.barbican.org.uk/media/upload/art/bauhauslistofloansforprotection.pdf> (accessed November 29, 2015). More recently, Krause's work has been included in the exhibitions *Bauhaus: The Art of the Students – Works from the Collection of the Bauhaus Dessau Foundation* (October 19, 2013 – January 26, 2014, Stiftung Bauhaus Dessau, Galerie der Stadt Remscheid) and "Big Plans! Modern Figures, Visionaries, and Inventors. Applied Modernism in Saxony-Anhalt 1919-1933" (4 May 2016 - 6 January 2017, Bauhaus Dessau Foundation, exhibited throughout Saxony-Anhalt). See also Matina Kousidi, "The Thread of Corona Krause, beyond the Bauhaus," in *AIS/Design: Storia e Ricerche*, Special issue *Italian Material Design: Imparando dalla Storia*, no. 4, November 4, 2014, <http://www.aisdesign.org/aisd/il-filo-di-corona-krause-oltre-il-bauhaus> (accessed September 12, 2017).

9 Krause's correspondence with the Bauhaus is located at the Sammlungsarchiv of the Bauhaus Foundation in Dessau.



Fig. 5. Corona Krause, No title, Watercolour composition (1924). Stiftung Bauhaus Dessau. Published in <[www.bauhaus100.de/en/past/people/students/corona-krause](http://www.bauhaus100.de/en/past/people/students/corona-krause)> (accessed September 12, 2017)

experimentation with forms prior to the undertaking of weaving practices.<sup>10</sup> Part of a set of three watercolour drawings revealing a wider experimentation with colours, rhythm and forms, this study also reveals the influence of Moholy-Nagy's visual experiments on Krause's formation (Fig. 5). For the majority of Krause's surviving artworks in the field of weaving, painting and drawing techniques were incorporated into

the preparation process, hence evidencing the intimate relationship between pictorial and textile arts. Both the documented and surviving artworks of that period bear evidence of the presence of pictorial textiles, featuring mainly of striped or plaid patterns, thus reinforcing the connection to the abstract artistic canvases of the Bauhaus painters. Following Sigrid Wortmann Weltge, instructions from the master painters, including Itten, Klee and Moholy-Nagy, were fundamental in shaping the weavers professional lives.<sup>11</sup>

'A floor part can form part of the overall composition of a room and as much can function as a spatially determining element', Bauhaus weaver Gunta Stölzl –the artist who held a determining role

<sup>10</sup> It also reveals the impact of Moholy-Nagy's artistic character on Krause's work, as this is reminiscent of one of his artworks produced one year earlier. See Maria Wegener and Wolfgang Werner, *László Moholy-Nagy zum 100. Geburtstag: Bilder, Aquarelle, Graphik, Protogramme der 20er Jahre* (Berlin: Kunsthandel Wolfgang Werner, 1995), Exhibition catalogue.

<sup>11</sup> Weltge, *Bauhaus Textiles*, 10. For posterior explorations into painting and weaving, apropos of the Bauhaus, see also "Die Geburt der Abstraktion aus dem Geiste des Textilen," in Markus Brüderlin et al. (eds.), *Kunst und Textil: Stoff als Material und Idee in der Moderne von Klimt bis Heute Herausgegeben* (Ostfildern: Hatje Cantz, 2014), 119–40, and Christian Wolsdorff, "Wir waren halt die Decorativen im Sternenbanner Bauhaus," in Friedrich Meschede et al. (eds.), *To Open Eyes: Kunst und Textil vom Bauhaus bis heute* (Bielefeld: Kerber, 2013), 60–81.

for the Weaving Workshop's activities from 1920– describes, 'but it can just as well be conceived as a self-sufficient "thing in itself" which, in its formal and colouristic language can treat some two-dimensional visual theme'.<sup>12</sup> Indeed, during the Weimar era of the Weaving Workshop, the emphasis was placed on artistic expression, reflecting in this way the instruction and the design philosophies of the master painters. For instance, a tablecloth, measuring 2.42 m by 0.88 m and featuring a striped, abstract weaving style, although undated, bears resemblance to Krause's studies during the Bauhaus preliminary course, and, more precisely, to the intersecting linear patterns illustrated in her experimentation with watercolour and typography.<sup>13</sup>

On the one hand, textiles were regarded as visual compositions of flat planes, emphasising their aesthetic, visual value. On the other, as their practical, functional role began to emerge, they were perceived as three-dimensional objects. Yet, Corona Krause and her co-students –Anni Albers, Benita Koch-Otte and Else Mögelin– would approach weaving in a thoroughly experimental way; they would re-evaluate craftsmanship and technique following modern means, whilst embracing the emerging needs of their time. The collection of thread swatches compiled and collated by Krause is indicative of thorough research into the blending of natural with artificial materials. This exploration led to the combination of threads innovative at that time, namely aluminium, cellophane and plastic threads, with wool, silk or cotton.<sup>14</sup> 'The women increased their scientific experimentation,' Magdalena Droste writes, noting that 'systematic experiments with new materials – cellophane, artificial silk, chenille, for example' had been inherent to the Weaving Workshop curricular synthesis, even prior to Hannes Meyer's directorship.<sup>15</sup> It could then be asserted that Corona Krause's thread sample is part of the wider investigation into materiality promoted by the Workshop in the early 1920s.<sup>16</sup> 'The work must now be carried out in an experimental way', Albers wrote in her 1924 text

<sup>12</sup> Gunta Stölzl, *Offset: Buch und Werbekunst*, (Leipzig: Bauhaus, 1926), series Bauhaus-Heft, vol. 7; Julia Engelhardt and Frank Whitford (eds.), *The Bauhaus: Masters and Students by Themselves* (London: Conran Octopus, 1992), 234.

<sup>13</sup> The table cloth is part of the Corona Krause's family-owned collection, which is currently hosted at the Sammlungsarchiv of the Bauhaus Dessau Foundation.

<sup>14</sup> 'Why do we continue to concern ourselves with weaving rather than look for entirely new materials which have the same qualities as woven fabric: which can be dyed, are elastic, can be made to any size, are easily divisible, soft, and above all economic, but which do not depend on the painstaking and, in spite of the extreme technical complications, formally restricted process of weaving? One day such a new artificial material will certainly exist. But that is a task for the chemical industry and the university laboratories. Once this material has been invented and can be economically produced, weaving for us will have finished.' Helene Nonne-Schmidt, "Das Gebiet der Frau im Bauhaus," *Vivos voco* 5, no. 8–9 (August – September 1926), cited upon Engelhardt and Whitford, *Students by Themselves*, 256.

<sup>15</sup> Magdalena Droste, *Bauhaus 1919–1933* (Cologne: Taschen, 1993), 184.

<sup>16</sup> This combination was characteristic of the Bauhaus weaving practices at that time, as in the case of Anni Albers –Krause's co-student– and her renowned curtain for the auditorium of the Federal School (*Allgemeinen Deutschen Gewerkschaftsbundeschule*) in Bernau. Featuring a mix of cotton chenille and cellophane threads woven on cotton warp, the employed materials of this silvery stage curtain were meant to insulate sound and reflect light, respectively.

'Bauhaus Weaving' ('Bauhausweberei') that featured in the 1924 special issue of the magazine *Junge Menschen* dedicated to the Bauhaus in Weimar. Drawing attention to the need to regain full contact with the employed material, after the rise of mechanisation, she went on to explain that the role of weavers at that time was to bridge the generated gap between the weaver and the employed material.<sup>17</sup>

And as the Bauhaus was an attempt not at a dictatorial stance over obedient 'subsidiary bodies' but was rather, a multiplicity of heads and aspirations,<sup>18</sup> the weavers held in their entirety an important role in articulating the turmoil of their times through artefacts of functional, aesthetic and utilitarian importance. The concept of modern textile design would be expressed in multiple ways as the weavers would develop prototypes and designs addressed to the industry and pave the way for contemporary textile design. Under the educational instructions of Georg Muche, the Master of Form, and Helene Börner, the Master of Craft, Krause produced works influenced by the realms of art, craft and new technologies. In line with the spirit of the Weaving Workshop in those days, Anni Albers, Krause's co-student, would indirectly inform the materialistic thesis of Gottfried Semper. Through the concentration on materiality, technology and functionality, a culture of artistic upholstery, wall hangings and designs for the textile industry would come to life, attributing the origins of a unique and innovative body of work to the 'moving images' produced at the Workshop.<sup>19</sup> In turn, Albers herself would expand on the methodological shift in the Workshop's practices:

It was a curious revolution when the students of weaving became concerned with a practical purpose. Previously they had been so deeply interested in the problems of the material itself and in discovering various ways of handling it that they had taken no time for utilitarian considerations. Now, however, a shift took place from free play with forms to logical composition. (...) The whole range of possibilities had been freely explored: concentration on a definite purpose now had a disciplinary effect.<sup>20</sup>

17 'Only the work by hand, with its slow process, allows any type of experiment, allows a complete formal creation, technique and material', Albers writes, as 'only in this way we can understand the industry as mechanical craft – we can work for the industry, because we have understood the substance' (Annie Albers, "Bauhausweberei," *Junge Menschen* 5, no. 8 (1924), 188.

18 Oskar Schlemmer's affirmation from his diary, June 1923 (translation by the author). Walther Scheidig and Klaus G. Beyer, *Bauhaus Weimar 1919–1924: Werkstattarbeiten* (Leipzig: Edition Leipzig, 1966), 5.

19 Markus Brüderlin, "Zur Ausstellung: Die Geburt der Abstraktion aus dem Geiste des Textilen und die Eroberung des Stoff-Raumes," in Brüderlin et al., *Kunst und Textil*, 14-45, here 35 (translation by the author).

20 Anni Albers, "The Weaving Workshop", 1938 in Engelhardt and Whitford, *Students by Themselves*, 234.

## Dress, More Than Meets the Skin

This new 'range of possibilities' concerning textiles, which Albers illustrated in her writings, was to be applied to a wide range of surfaces from walls to furniture to female bodies, introducing new dynamics between the spatial and the corporeal realms. Despite the prominent position of textile artworks in the interior spaces orchestrated by the different departments of the Bauhaus School,<sup>21</sup> the element of dress, however, held a subordinate, nearly obscure, role. It mainly pertained to the ephemeral sphere of costume design, apropos both the Stage Design Workshop directed by Oskar Schlemmer and the informal festivities that traversed the Bauhaus calendar.<sup>22</sup> In both cases, dress represented a fertile terrain for experimenting with the distortion of the bodily silhouette, through the donning of voluminous, geometrical costumes and the exploration of the body's overall visual and tactile appearance through the adaptation of peculiar materials such as metallic wire, foam or natural hair.<sup>23</sup> Dress emerged as a continuation and integral part of the spatial environment in which it was being hosted, framing the aesthetic character of these isolated moments in the School's life span.

Wassily Kandinsky's appearance in traditional 'lederhosen', in celebration of the acquisition of the German citizenship in 1928,<sup>24</sup> the original, imaginative costumes of the Bauhaus parties, 'inhuman, or humanoid, but always new',<sup>25</sup> the renowned costumes of Oskar Schlemmer's *Triadic Ballet* (*Triadisches Ballett*), or even Johannes Itten's outfit, which comprised a red-violet, high-buttoned

21 'Simpler, arguably more easily mass-producible objects on the list, such as tablecloths, pillows, scarves, or drapes being produced in the Weaving Workshop, are notably absent from the catalogue.' Jeffrey Saletnik and Robin Schuldenfrei (eds.), *Bauhaus Construct: Fashioning Identity, Discourse and Modernism* (London and New York: Routledge, 2010), 49.

22 The role of dress and costume design in the Bauhaus School has been described in few studies from the past decades, among which Ute Ackermann, "Bauhaus Parties – Histrionics between Eccentric Dancing and Animal Drama," in Jeannine Fiedler and Peter Feierabend (eds.), *Bauhaus* (Potsdam: Ullmann, 2007), 126–39; Juliet Koss, "Bauhaus Theater of Human Dolls," *The Art Bulletin* 85 (2003), 724–45; and Farkas Molnár, "Life at the Bauhaus," in Timothy O. Benson and Éva Forgács (eds.), *From Between Two Worlds: A Sourcebook of Central European Avant-Gardes, 1910–1930* (Cambridge, Mass.: The MIT Press, 2002), 462–65.

23 Klee also recalls that 'one colleague, for example, by the name of Pascha, had a long mane that came down all the way to his shoulders, like the Beatles today. One day, in full public view, he was shorn of his adornment. But more important [sic.], Pascha artfully made this hair the central point of one of his studies of materials.' Neumann, *Bauhaus People*, 41.

24 Kathleen James-Chakraborty (ed.), *Bauhaus Culture: From Weimar to the Cold War* (Minneapolis: University of Minnesota Press, 2006), 110.

25 'The greatest expenditures of energy, however, go into the costume parties. The essential difference between the fancy-dress balls organized by the artists of Paris, Berlin, Moscow and the ones here at the Bauhaus is that our costumes are truly original. Everyone prepares his or her own. Never a one that has been seen before. Inhuman, or humanoid, but always new. You may see monstrously tall shapes stumbling about, colorful mechanical figures that yield not the slightest clue as to where the head is. Sweet girls inside a red cube. Here comes a winch and they are hoisted high up into the air; lights flash and scents are sprayed.' Farkas Molnár, "Life at the Bauhaus" 1925, in Benson and Forgács, *Between Worlds*, 465.

uniform and gold-rimmed glasses<sup>26</sup> and was influenced by the Mazdaznan philosophy with which he became acquainted in the period between 1923 and 1926, are a few of these moments. Apart from the peripheral and exaggerated manifestations of attire in the School, a part of the surviving Bauhaus dresses refers to sartorial creations of quotidian use, explicitly associated with the textile artists of the Weaving Workshop.<sup>27</sup> Most famously, the dress produced by Lis Volger in 1928 survives through the renowned black and white picture of Enrich Consemüller,<sup>28</sup> in which a female figure leans back on a B3 club chair designed by Marcel Breur, while looking at the camera through a painted metallic mask designed by Oskar Schlemmer. Approximately one-meter long so as to end just above the knee, Volger's dress was made of cotton and artificial silk threads and comprised a discreet striped pattern. Despite the pivotal role that dress held in the scenography of this picture, the production of female attire at the Weaving Workshop held an obscure role. Juliet Koss writes:

Her Bauhaus environment has encased and absorbed her: chair, dress, head. She is clearly female, but her slim body, ovoid head, and the pared-down fashions of the Weimar New Woman all suggest androgyny, reproducing the effect of Schlemmer's padded dolls from the other side of the gender divide. (...) That the figure cannot be identified, rather than detracting from the documentary value of the photograph, certifies a central feature of Bauhaus life: the defining presence of the doll seemingly female and certainly anonymous.<sup>29</sup>

In the extensively cited Consemüller frame, dress arises as both a sartorial and a spatial element: it is part of the interior environment that hosts and 'absorbs' the concealed woman, whilst hinting at a male-female ambiguity, cogent on different levels at the Bauhaus. Apart from raising awareness on the gender issues at the School, dress is equated here to a commodity that anchors the female self to its modern context, engaging –as textiles did– in a 'practical purpose'. It is into this framework of dress as a commodity that a sartorial piece of Corona Krause can be integrated (Fig. 6), comprising, together with Volger's dress and one of Margaretha Reichardt,<sup>30</sup> the dress collection currently stored at the archives of the Sammlungsarchiv of the Bauhaus Dessau Foundation.



Fig. 6. Corona Krause, Female dress (ca. 1927). Courtesy of Bauhaus Dessau Foundation (photo Library).

In their entirety, the dresses kept at the archives of the Bauhaus Dessau Foundation are stripped from any excessive element of ornamentation and echo the simplicity, geometrical abstractness and functionality of the rest of the textile artefacts produced at the Workshop. In particular, Krause's dress features a soft linear pattern, a straight A-line form and a length of approximately 1,10 m. Given its minimalistic form and loose shape, it allowed for the free movement of the female body, in a similar way as the dresses of Reichardt and Volger. The addition of a line of buttons and a large pleat on its front side, however, differentiate the dress aesthetically from the other two artefacts and are potentially the elements that reveal a later date of origin than the years of Krause's Bauhaus formation. Following the archive listing, the dress is attributed chronologically to the year 1927, a time when the artist assisted with teaching at the Burg Giebichenstein Kunsthochschule (Giebichenstein Artistic Highschool) in Halle. Yet, its similarity to the rest of the surviving dresses is remarkable, not only in terms of pattern and form, but also in terms of composition, therefore reflecting the firm influence Krause's stay at the Bauhaus had on her subsequent work.

The Burg Giebichenstein Kunsthochschule in Halle, located approximately fifty kilometers south of Dessau, was established in 1915 with architect Paul Thiersch appointed as its first director. Described as a more traditional, craft-oriented institution than the Bauhaus, it followed the principles of the Deutscher Werkbund (German Association of Craftsmen) and comprised various thematic workshops that ranged from metalwork and ceramics to bookbinding and pottery. Weaving was also part of the School's curriculum and in view of this, several former members of the Bauhaus Weaving Workshop in Weimar saw an opportunity to move to Halle instead of following the relocation of the Bauhaus School to Dessau. Among these members was Benita Koch-Otte, a former co-student and close friend of Krause, in whose steps Krause was about to follow. 'When the Bauhaus moved to Dessau and embraced technology and industry,' Weltge writes, Koch-Otte 'joined an exodus of anti-industrialist artists, accepting an offer

26 Felix Klee's recollection of the director of the Vorkurs, Johannes Itten. Neumann, *Bauhaus People*, 40.

27 Sporadic approaches towards quotidian female attire from within the School, would be associated with Bauhaus alumni, such as Ré Soupault and her multifaceted transformation dress [see Manfred Metzner (ed.), *Ré Soupault: Das Bauhaus – die heroischen Jahre von Weimar* (Wunderhorn: Heidelberg 2009)] or as Wassily Kandinsky and his 1919 designs for female dresses [see Sigrid Wortmann Weltge, *Bauhaus-textilien: Kunst und Künstlerinnen der Webwerkstatt* (Zürich: Stemmler Verlag, 1993), 50].

28 See Juliet Koss, *Bauhaus Theater*, 731–2; Magdalena Droste and Ludwig Manfred (ed.), *Das Bauhaus Webt: Die Textilwerkstatt am Bauhaus* (Berlin: Grete Häusler Verlag, 1998).

29 Juliet Koss, "Bauhaus Theater of Human Dolls," 724–45, here 731–2.

30 On Margaretha Reichardt see Barbara Rausch (ed.), *Grete Reichardt: Textilgestaltung* (Weimar: Kunstsammlungen zu Weimar, 1977), Exhibition catalogue; and *Margaretha Reichardt (1907–1984), Textilkunst* (Erfurt: Angermuseums Erfurt, 1994), Exhibition catalogue.

from Gerhard Marcks to head the Weaving Department at Burg Giebichenstein'.<sup>31</sup> The school in Halle focused on the cross between artistic excellence and craftsmanship, small-scale production and tradition, and in this context, a female dress of a more decorative, artisanal character – such as Krause's sartorial piece that survives in the Bauhaus Dessau archives – could be produced.

The dress consists of natural threads, accentuating in this manner its intention as an utilitarian, personal object that would align with the extensive quest for functionality. At the beginning of the 1920s, Lilly Reich in her text entitled 'Questions of Fashion' ('Modefragen'), published in 1922 discusses the changing character of dress in those days, highlighting its quotidian, but also contextual significance. More precisely, she explains that:

Clothes are objects of use, not artworks. They are subject to the requirements of the day. And yet clothes can produce metaphysical effects through their inherent orderliness, their peace and restraint, their coquettish gaiety and liveliness, their playful grace, their healthy simplicity, and their dignity. (...) But this service that fashion can provide must adhere to the necessities of life and reflect the requirements of the time: fashion must have discipline.<sup>32</sup>

Dress could thus be regarded as a symbolic and tangible manifestation of new ways of being within clothing and, by extension, within space. The tendency, as these pieces of female attire reveal, was for dress to become one of the 'standard types for practical commodities',<sup>33</sup> following the respective mandate of the Bauhaus Workshops. The small number of Krause's surviving sartorial designs, in combination with the rest of the remaining dresses at the Bauhaus Dessau archives, may hold the key to the inclusion of dress in the orchestration of the aesthetic character of a given space. Across the borders, similar intersections between spatial, textile and dress design were underway, through the case of artists that their work crossed the boundaries between dress, textile, spatial and stage design, such as Paul Poiret, Sonia Delaunay and Lyubov Popova.

Meant to align with the modern requirements for a freed female silhouette, which were accompanied by visions for the liberation of women's social position, the dresses kept at the Bauhaus Dessau archives have considered in-depth the versatile needs of women at that time. Seen as a continuation of the dresses of Reichardt and Volger, Krause's creation can be regarded as a vehicle of modern

concepts of enveloping the body, alongside a sense of anatomical comfort and hygiene. In tune with the changing role of women in those days, the dress addressed the necessities of the body in a way comparable to the dress-reform movement that had preceded and had similarly drawn attention to new appreciations of the female anatomy and its movement. Similarly, the weavers of the Bauhaus realised that the application of historicist fabrics could only be applied partly to modern products and pieces of furniture, identifying the need for replacing anachronistic modes of attire; 'the present, of which they were so much a part, provided a challenge to which they responded with enthusiasm'.<sup>34</sup>

For Corona Krause, as for the entirety of the Bauhaus female weavers who addressed both the terrains of female attire and interior space, textiles were considered to be inextricable parts of the architectural scenography, in line with the guidelines and holistic visions of their male instructors. For them, textiles were regarded as functional, timeless elements, rather than as changeable, ephemeral accessories, as they adequately corresponded to the rising changes in the wider interior, sociocultural and temporal environment. They can therefore be appreciated as pivotal quotidian artefacts, rather than as mere accessories, equally important to the spatial composition as pieces of furniture and domestic objects. Krause's artworks comprised a thread, which associated the various means of enveloping the human body with modern ways of artistic and material expression, with her educational stay at the Bauhaus being the foundation and starting point of the complex 'weave' of her life course.

Crossing between the production of textiles intended for clothing and those designed for the coating of domestic elements, Krause's contribution to modern textile design has been broad. The breadth of her portfolio, and its association with distinguished artists of that historical context, sheds light on the need to unknot and retie modern historiographies of the Bauhaus State School, and in particular of the distinct members of the Weaving Workshop. As the artist's profile remains obscure, despite the significant impetus she gave to the field of modernist textiles, questions arise regarding issues of gender, female representation, and publicity that have influenced historical narratives. Krause's case could be understood both as an isolated case of a Bauhaus alumna that demands further investigation, and also in relation to the wider terrain of the art of weaving in Germany at that time, but also as part of a wider group of artists who although active members of the Bauhaus School, produced work that remains under-explored. The present paper has attempted to lay the basis for further scholarly initiatives on the subject, drawing awareness to the broader, and highly relevant, topics of female representation and inclusion, artistic production and craftsmanship, cross- and interdisciplinary practices, within and beyond the boundaries of the Bauhaus loom.

31 Weltge, *Bauhaus Textiles*, 60.

32 Lilly Reich, "Modefragen," *Die Form: Monatsschrift für gestaltende Arbeit* 1, no. 5 (1922), 7–9; Robin Schuldenfrei, "Introduction," in "Questions of Fashion by Lilly Reich," *West 86th: A Journal of Decorative Arts, Design History, and Material Culture* 21, no. 1 (2014), 102–20, here 120, <http://www.west86th.bgc.bard.edu/translated-text/questions-of-fashion-reich.html> (accessed July 4, 2017). On Lilly Reich see also: Sonja Günther, *Lilly Reich 1885–1947: Innenarchitektin Designerin Ausstellungsgestalterin* (Stuttgart: Deutsche Verlags-Anstalt, 1988); Matilda McQuaid and Magdalena Droste (eds.), *Lilly Reich, Designer and Architect* (New York: Museum of Modern Art 1996), and Esther da Costa Meyer, "Cruel Metonymies: Lilly Reich's Designs for the 1937 World's Fair," *New German Critique* 76 (1999), 161–89.

33 Saletnik and Schuldenfrei, *Bauhaus Construct*, 49.

34 Weltge, *Bauhaus Textiles*, 44.

## Acknowledgements

I would like to express my appreciation to the members of the MoMoWo research project for initiating this conference-workshop event. My sincere thanks are due to artist Jakob Gautel –grandson of Corona Krause– for his valuable insights, to Nina Schönig at the Bauhaus Archives in Berlin, to the Library and Archives of the Bauhaus Foundation in Dessau. The support of the Swiss Academy of Humanities and Social Sciences has been indispensable for the development of this paper.

### Matina Kousidi

Postdoctoral Fellow at the Institute for the History and Theory of Architecture gta/ ETH Zurich



Dr. Matina Kousidi is an academic guest at the Chair for the Theory of Architecture Prof. Dr. Laurent Stalder at the Institute for the History and Theory of Architecture gta, Swiss Federal Institute of Technology Zürich. Previously, she has been the recipient of a DAAD postdoctoral scholarship, which allowed her to conduct research from within the Humboldt University of Berlin and teach at the Master's in Architecture program of Dessau Institute of Architecture. Dr. Kousidi was conferred her fully-funded PhD in Architecture at Sapienza University of Rome. She is interested in the interrelations between architecture and dress in modern and contemporary design practices.

E-mail: [mail@matinakousidi.com](mailto:mail@matinakousidi.com)

## The Pliable Plane: Textiles, Space, and the Work of Anni Albers

In 1922, Anni Albers (1899–1994) joined the Bauhaus School in Weimar. She expressed interest in architecture, but was refused entry to the male-only construction workshop (der Baukurs) and was directed to the weaving workshop. Between 1922 and 1933, Albers produced wall hangings and designs for commercial fabrics. My research examines her textiles work according to Bauhaus architectural ideals.

I position Albers' work in the context of German architect and theorist Gottfried Semper's (1803–1879) definitions of architecture. Semper proposed that architecture is motivated by four 'elements': the hearth, mound, roof and enclosure. Just as Semper asserts that textiles are the ancestors of enclosures in his treatise *Der Vier Elemente der Baukunst* (1851), I argue that Albers wall hangings fulfil the function of spatial dividers. I argue that her interest in spatial concerns, and her use of theoretical approaches indicate that Albers' textiles are literally and metaphorically flexible enough to fulfil myriad functions in a Bauhaus interior, and as a result, that the term 'wall-hanging' belies a richness of meaning. An expansion in categorisation of her work as wall hangings contributes to a clearer understanding of Albers' oeuvre as manifestations of theoretical approaches at work in the Bauhaus during her time there.

Keywords: Anni Albers, wall hangings, architecture, Gottfried Semper, spatial division

The title for this investigation comes from the first chapter of Albers' 1954 monograph, *On Weaving*, and from a later article originally published in *Perspecta* in 1957.<sup>1</sup> In it, Albers defines weaving as a method of 'forming a pliable plane of threads by interlacing them in a rectangular way.'<sup>2</sup> I find this language evocative and provocative: it was Albers' words that led me to this investigation of her textiles. One of the first of Albers' works which I encountered as I embarked upon this exploration is a representative instance of Albers' interior fabrics, which bears a significant title: *Wall-hanging* (Fig. 1). This piece gives us a sense of the dominant type of textiles Albers made at the Bauhaus.<sup>3</sup> Like others of Albers' pieces called 'Wall-hanging', this example is longer than it is wide, and its length exceeds one hundred centimetres. It is comprised of a combination of different fibres, including silk, as it does in many of Albers' other compositions. This gives us some idea about how heavy these pieces might be: they are made more substantial by the inclusion of heavier materials, like cotton. The silk in their compositions gives these fabrics lightness, and aids in the reflection of light and colour brilliancy. Finally, this wall hanging gives us an indication of the stylistic qualities shared by Albers' works from this time period. It features limited colour palettes, and a focus on straight implied lines, especially horizontal lines, which are kept to a grid.

This exploration deals with determining what exactly is meant by 'Wall-hanging', and what this might mean for Albers' ideas about architectural space. It might be tempting to assume that a wall hanging is simply that which hangs on a wall. The title of this work suggests something straightforward regarding its role in interiors, but this term belies its own richness. Albers' fabrics have been fixed upon walls, but also hanging from ceilings: wall hangings like the example from 1924 (Fig. 1) have been displayed by the Museum of Modern Art (MoMA) New York and the Bauhaus-Archiv, and

1 Anni Albers, "The Pliable Plane: Textiles in Architecture," *Perspecta: The Yale Journal of Architecture* 4 (1957), 36–41, abridged and reprinted as "Fabric: The Pliable Plane" in *Craft Horizons* 18 (July-August 1958), <http://www.annialbersfoundation.org/teaching/anni-albers/texts/#tab4> (accessed January 23, 2016).

2 Anni Albers, *On Weaving* (New Haven: Wesleyan Press, 1965), 59.

3 After having moved to America, Albers continued to work in textiles, but produced fewer wall hangings, and focused instead on smaller weavings and designs for industry.



Fig. 1. Anni Albers, Wall-hanging, 1924.

the Albers' Foundation hanging against walls.<sup>4</sup> Similarly, her cotton and linen curtain in Harvard's Graduate Student Centre, designed by Walter Gropius, was suspended from the ceiling and separated shared living quarters for increased privacy for the residents (Fig. 2). While she made this piece after she left the Bauhaus, and Germany, the curtain was used for a space designed by another *Bauhausler*, Gropius, and shares similar materials with other commercial fabrics from her Bauhaus years, many of which no longer survive. The varied possibilities for these textiles' situation, and by extension the word 'wall-hanging' itself, also suggests that we can play with the word: Albers' textiles might be used as wall hangings, but also as hanging walls. In this way, we engage with Albers' interest in architecture by manipulating language to create a link between two apparently disparate media: architecture and textiles.

If these weavings can act as hanging walls and as wall hangings, then perhaps part of their function is spatial division. The idea of using textiles as potential spatial dividers in an interior may have come from Gottfried Semper.<sup>5</sup> Semper was a nineteenth-century German architect, designer, and theorist. Semper was active in Germany as an architect. Among his architectural projects are the Semper Opera House in Dresden, and re-designing the Ringstrasse in Vienna. He fled Germany after taking part in the May Uprising in Dresden of 1849. Semper lived in Zurich and London until 1862, when he returned to Germany and resumed his work as an architect. Throughout his career, Semper was a major proponent of polichromy in Greek sculpture, a controversial topic at the time. He also wrote about the relationships between architecture and other art forms in, among others, his works *Der Stil* and *Der Vier Elemente der Baukunst*.<sup>6</sup> In these texts, he presents the four elements generating architectural forms. They are the hearth, roof, mound, and enclosure.<sup>7</sup> The use of the term 'elements' can be misleading.

4 The Museum of Modern Art in New York also contains later examples of Albers' wall hangings, dating from 1949 and onward. For more, see Barry Bergdoll and Leah Dickerman (eds.), *Bauhaus 1919–1933: Workshops for Modernity* (New York: Museum of Modern Art, 2009), exhibition catalogue.

5 Semper's views are considered by Bauhaus historians like Giedion and Smith to belong to the pre-modern era, even though it would appear that Semper's ideas continued to influence *Bauhäusler* like Gropius and Albers.

6 These texts are much studied, and have provided the theoretical basis for many analyses of nineteenth and twentieth century architecture. For more information on Semper, see the *Journal of Art Historiography* online. For more analysis of Semper's work in relation to textiles, Rebecca Houze has authored some excellent material.

7 Gottfried Semper, *The Four Elements of Architecture and other Writings* (Cambridge: Cambridge University Press, 1989), 24, translated by Harry Francis Mallgrave and Wolfgang Hermann.

Semper's later publications clarify that he conceived of them not as material elements or forms, but as 'motives or ideas, as technical operations based in the applied arts.'<sup>8</sup> This is to say that architecture does not actually have to have a physical hearth, roof, enclosure or mound in order to count as architecture. Instead, these four elements serve motivations that are present in all forms of architecture. These motivations, according to Semper, are: heating and warmth; protection from weather; removal from the ground; and spatial division.

The enclosure or wall as a spatial divider will be the focus of this article. The enclosure, according to Semper's definition, is that architectural element that 'formally represents and makes visible the enclosed space as such, absolutely, as it were, without reference to secondary concepts.'<sup>9</sup> The enclosure acquires its architectural value by defining a 'new spatiality' or inner world separated and protected from the outer, also by surrounding the hearth.<sup>10</sup> Each of the four elements corresponds to a particular technique of working process, developed both in a ritual and a functional sense in the practical arts. The enclosure originated with wickerwork, and therefore is a product of the technique of weaving.<sup>11</sup> We can see this connection perhaps most clearly in examples of wattle and daub construction from medieval Europe, which use stripped saplings woven between wooden posts and covered with mud to form substantial, hardy walls.

This weaving technique, Semper notes, is the first motive, which emerged in the intertwining of branches for fences and pens, which later evolved into the art of weaving with bast and wicker, later with woven threads. Semper asserts that the wall-fitter or *Wandbereiter*, that is, the weaver of mats and carpets, is the 'ancestor' of the architect.<sup>12</sup> He also argues that the beginnings of building coincide with those of weaving, and the first volume of *Der Stil* was meant to provide substantial

8 Semper, *Four Elements*, 24.

9 Semper quoted in Mari Hvattum, *Gottfried Semper and the Problem of Historicism* (Cambridge: Cambridge University Press, 2004), 71.

10 Semper, *Four Elements*, 23.

11 Hvattum, *Historicism*, 15.

12 Semper, *Four Elements*, 103.



Fig. 2. Anni Albers, Wall-hanging, 1924.

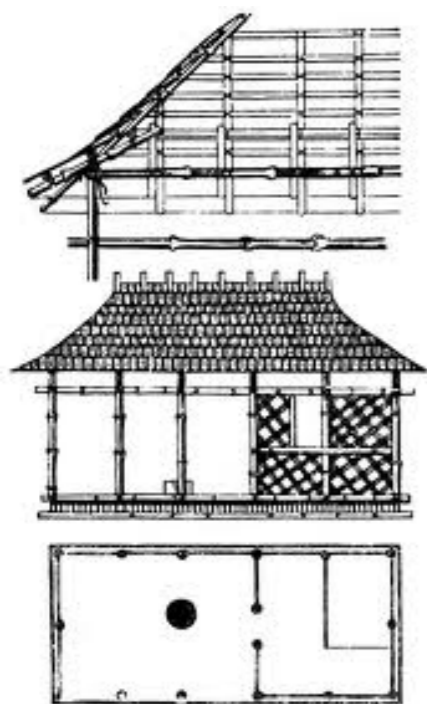

Fig. 3. Diagram of the Caraib Hut, Trinidad Display, Great Exhibition, 1851 (London, UK). Published in Gottfried Semper, *The Four Elements of Architecture and Other Writings* (Cambridge: Cambridge University Press, 1989).

documentation for this assertion.<sup>13</sup> The influence of the carpet in its capacity as a wall, as a vertical means of protection, had a significant impact on the evolution of certain architectural forms.<sup>14</sup> Walls, then, spring directly from acts of gathering and enclosing, acts expressed both practically and symbolically in the motifs of the textile arts.

An example of this can be found in Semper's *Der Stil*. A diagram, which depicts elements of a Caraib structure, was drawn from an example on display at the Great Exhibition of 1851 in London, England (Fig. 3). The hut illustrated for Semper the four motives in their simplest combination.<sup>15</sup> The illustration he provides shows the wall between the support posts of the roof as black intersecting lines. This interwoven material is akin to the warp and weft of a textile.<sup>16</sup> The supports, according to Semper's theory, are part of the roof, not the walls.<sup>17</sup> The materials that fill the space between the posts are the walls. In this instance, Semper looked beyond the spun threads of a weaving or inter-woven plant matter of the Caraib hut to focus on the role of the woven structure: that of the spatial divider. We can perhaps imagine how he made such a link: some fibres like hemp or jute are similar in structure and appearance to other more sturdy materials normally associated with

building materials, like bamboo or wood. Both are naturally occurring, plant-based, and share similar physical characteristics, like their light weight and tensile strength. The similarity in physical properties between textile and building materials also means that similar construction techniques exist in both the fibre arts and architecture. In this case, we can see that the inter-woven strands of plant fibre making up the Caraib hut resemble the warp and weft of a textile. The plant fibres in the hut were flexible enough to shape and bend to allow for weaving, while still maintaining tensile strength to produce a 'filler' that stretched between the roof supports of the structure. As a result,

<sup>13</sup> Hvattum, *Historicism*, 70.

<sup>14</sup> Semper, *Four Elements*, 103.

<sup>15</sup> Semper, *Four Elements*, 28.

<sup>16</sup> Warp threads are the upright, vertical threads of a weaving which provide structure for the fabric and do not move during the weaving process. Weft threads intersect the warp threads horizontally, and are manipulated by the weaver to 'fill' the spaces between the warp.

<sup>17</sup> Semper, *Four Elements*, 28.

Semper identified the interwoven material of the wall as akin to warp and weft. As such, it was possible for Semper to see beyond material or contextual concerns, and recognise a similarity of process and construction between woven textiles and woven wall structures.

This is not to say that Semper did not consider materials or context important: quite the opposite is true. The physical characteristics of materials, and their bearing on production processes were important to Semper. As part of a generation that endeavoured to explain cultural phenomena in historical and anthropological terms, Semper sought the roots of architecture in empirical facts. The 'primitive' hut was not, for Semper, the original, or universal, but an empirical phenomenon. It revealed both a timeless principle, and the particular historical conditions from which it originated.<sup>18</sup> He argues that the historical conditions of architecture begin with the history of practical art. This history of practical art, in turn, begins with the motifs, simultaneously embodying function, technique, and ritual action.<sup>19</sup> Semper was preoccupied with the origins of art in some primordial human condition and with revealing the development of art as a metamorphosis of motifs: these were key points in Semper's thinking on art.<sup>20</sup>

Albers' thoughts on textiles in architecture appear to echo Semper's assertions. It seems certain, then, that Albers was thinking about her work as an exploration of the basic means of one of architecture's most fundamental motives. Albers acknowledges the same functions accomplished by textiles that Semper champions: warmth, separation from the ground, shelter from the elements, and of course, spatial division.<sup>21</sup> Albers goes on to assert that the roles played by textiles in interiors have diversified even further, to include sound absorption and light reflection, among others.<sup>22</sup> By relating her work to Semper's theory, it is possible that Albers was reminding those same Bauhaus masters who refused her entry to the *Baukurst*, and who viewed the textile arts produced in the weaving workshop as dilettante and superfluous, that the very practice of building from which she was denied, and which was held in high regard in the Bauhaus, actually developed from the textile arts. She notes that

It is interesting in this connection to observe that in ancient myths from many parts of the world it was a goddess, a female deity, who brought the invention of weaving to mankind. When we realize that weaving is primarily a process of structural organization this thought is startling, for today thinking in terms of structure seems closer to the inclination of men than women.<sup>23</sup>

<sup>18</sup> Hvattum, *Historicism*, 35.

<sup>19</sup> Hvattum, *Historicism*, 14.

<sup>20</sup> Hvattum, *Historicism*, 10.

<sup>21</sup> Albers, "The Pliable Plane," <http://www.albersfoundation.org/teaching/anni-albers/texts/#tab4>.

<sup>22</sup> Albers, "The Pliable Plane," <http://www.albersfoundation.org/teaching/anni-albers/texts/#tab4>.

<sup>23</sup> Albers, "The Pliable Plane," <http://www.albersfoundation.org/teaching/anni-albers/texts/#tab4>.

In this way, we can see evidence of Albers' subtle refusal to be relegated to the position of amateur: her use of textiles in architecture was an act of resistance, and Semper's theory gave her the tools she needed to express her ideas and participate in a creative dialogue from which she had been barred. Semper's insistence that the textile arts were the ancestors of architecture, which paralleled her own views on her work, allowed her to accomplish this resistance.

Indeed, Semper asserts that hanging carpets remained the true walls, the visible boundaries of space. The often solid walls behind them were necessary for reasons that had nothing to do with the creation of space, rather, they were needed for security, for supporting a load, for their permanence, and so on.<sup>24</sup> With the need for warmer and more solid walls, the textile hanging became a 'dressing', and subsequently was replaced by other surrogate dressings, like stucco or wood. In 'all cases (Semper's emphasis) the motive and spatial essence of the wall' were enacted by the dressing, not by the supporting and contingent wall-prop behind.<sup>25</sup> In this way, Semper not only relates architecture to its origins in craft practice, he also notes the reliance on flexible textile structures where pattern, material, and form were interrelated.<sup>26</sup> Wherever the need for these secondary functions did not arise then the carpets remained the original means of separating space.<sup>27</sup> When we look at images of Albers' textiles, we can see that the insertion (or re-insertion) of textiles as important elements in architectural spaces would remind inhabitants that solid, load-bearing walls were not required for textiles to exist in a space. Indeed, according to Semper, it is actually the solid, plastered and painted wall that owes its existence to the textile.

Textiles in their architectural, spatial roles were not, however, only about enclosure. In Semper's theory, as well as at the Bauhaus, they related to thinking about a range of sensory engagement. In *Der Stil*, Semper traces the origin of monumental architecture to the 'improvised festival and stage apparatus.'<sup>28</sup> Semper argues that the ritualised event and the impending sensory experience precede the architectural form. In his argument, he offers up the impromptu covered market, or festival tent, as the ancestor of Egyptian, Greek and Roman architecture, respectively.<sup>29</sup> In these festival-type instances, the physical object dissolves into experience, into sensory perception and feeling.

These examples refer directly to Semper's ideas about the visceral experience of a space: one that he calls the 'festival'. Semper posits that the decorations on public monuments were 'initially

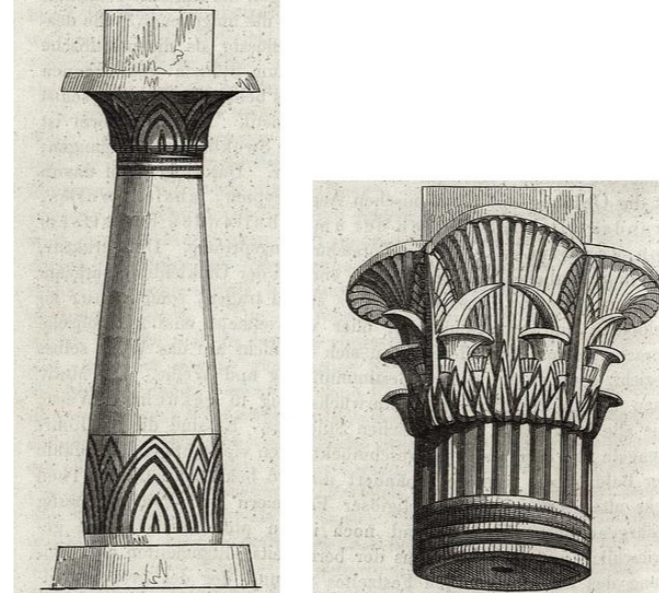

Fig. 4. Drawing of Columns with Calyx-shaped Capitals, Egyptian, Old Kingdom (date unknown). Published in Gottfried Semper, *Der Stil: Band 1: Die Textile Kunst* (Stuttgart: J.G. Sprandel'schen Buchdruckerei, 1860).

XXXXXXXXXXXXXXXXXXXX

planned to last only as long' as the festival for which the decorations had been made.<sup>30</sup> As such, textiles made for excellent festival apparatus since they were easy to remove once a ritual or festival had taken place, but worked well to separate sacred spaces from secular ones during holidays or celebrations. Textiles adorning exterior façades and interior spaces alike, as well as separating spaces during celebratory moments worked to develop a sensory experience of those festive times (Fig. 4). Observers and visitors to a temple would be alerted to the potentially sacred, but certainly liminal, time and space of a festival by textiles which were used to indicate the nature of the ritual. In this way, the visual experience of a textile, in conjunction with other sensory stimuli, would

develop for the participant a distinct sense of 'festival-ness'. Indeed, nearly every time he brings up the concept of the festival in his treatise *Der Stil*, Semper references textiles.<sup>31</sup> As such, textiles in this context, according to Semper, work to establish and further the visceral comprehension of festive spaces in the viewer by their very presence.

We can see Albers engaging with her audiences in a way that aligns itself with Semper's notions of the ritual, sensory event by using a visual language present at the Bauhaus to engage with her viewers. Albers uses geometric abstraction and juxtaposed fields of colour to suggest the dematerialisation of matter into perception, into its essence, grasped through the senses. Her use of flattened planes of colour and implied horizontal lines, which maintain a grid-like pattern, might be read as a visual representation of the moment of dissolution for the audience. While she may be depicting physical objects, her employment of geometric abstraction shows us those physical objects swimming before our eyes into insubstantiality. The central horizontal line of on the surface of *Wall-hanging* (1924) stretches from one side to another, recalling Semper's notion of hanging textiles draped between columns on a temple.<sup>32</sup> The remnants of these draperies, in Semper's view, could be found in columnar decoration that signalled the vestiges of textile decoration, namely 'garlands, draperies, tapestries', which 'sheathed' or 'dressed' the hollow underlying.<sup>33</sup> Semper points to a pair of ornamented Egyptian columns to support his claim (Fig 4). These columns, with their calyx-style capitals and decorative patterning around their bases, recalled for Semper the

24 Semper, *Four Elements*, 104.

25 Semper, *Four Elements*, 24.

26 Sarah Alfoldy and Janice Helland (eds.), *Craft, Space and Interior Design, 1855–2005* (Hampshire: Ashgate Publishing Limited, 2008), 1.

27 Semper, *Four Elements*, 104.

28 Semper, *Four Elements*, 2.

29 Gottfried Semper, *Der Stil* (Stuttgart: J.G. Sprandel'schen Buchdruckerei, 1860), 248.

30 Semper, *Stil*, 285.

31 Semper, *Stil*, 249, 285, 294, 433.

32 Semper, *Stil*, 280, 317.

33 Semper, *Stil*, 362.

garlands, banners, tapestries and draped fabrics which were, in his estimation, previously attached to columns for festival use, but had since been replaced by other modes of coloration and decor. Instead of depicting a realistic image of an ancient temple adorned with textiles during a festival, however, Albers develops a sense of abstracted, but nonetheless real, space. Now, instead of focusing on the object itself, we are encouraged to examine how we perceive the object: through colour, shape and texture. This abstraction appears to be in keeping with the shift in materials over time that Semper notes in his monographs: the style, colour, location, and form of the decoration and patterning in temple architecture did not change, so much as the materials and physical qualities of that decoration did. The sensory experience of the garlands and banners continued for temple-goers, long after the garlands themselves has been replaced by fresco. As such, Albers may be recalling the moment of visceral experience as the antecedent for architectural forms, including textiles, through geometric abstraction.

A particularly strong element of her approach to geometric abstraction in her surface design on her wall hangings is the horizontal line. This component also works to link Albers' wall hangings with Semper's theory. Semper mentions the tapestries and textiles stretched horizontally between the columns of a Pompeiian temple, especially for important festivals and religious events. The horizontal bands that run from side to side in *Wall-hanging* (1924) might recall those ancient festival fabrics. It also reminds the viewer that, according to Semper's theory, enclosures are not structural, but are stretched or suspended between the upright, vertical posts or supports of a building, which are actually part of the roof. In this way, Albers may be prompting her audience to remember that textiles are the ancestors of walls, and thus have a place alongside other architectural elements.

Further investigation of Semper's notion of the festival clarifies Albers' approach to surface treatment. Semper asserts that in Roman temple architecture, woven partitions hung between columns to furnish different zones. In his Pompeiian examples, for instance, the intercolumnnar drapery was retained in the form of a fresco, constituting, according to Semper, 'nothing more than the imitation (*Nachahmung*) of the draperies and screens that used to furnish and enclose the stoas and halls.'<sup>34</sup> He goes on to claim that the principle of dressing has greatly influenced style in architecture and other arts in all periods and in all nations. Indeed, he asserts that the relation between Pompeiian wall-paintings and earlier draperies is 'so obvious that no further evidence is needed from ancient writers'.<sup>35</sup> Despite this grand claim, there may be a granule of truth in his correlation between dressing the body and the building. In this way, Semper considers the appearance of the textile motive in architecture – his most important thesis of dressing. Ultimately, it is his justification for polichromy.<sup>36</sup>

'Polichromy', from the Greek for 'many colours', is the use of more than one colour in decoration or adornment, especially in sculpture and architecture. In the nineteenth century, however, it referred to a growing argument for a change in the interpretation of classical artefacts and archeological finds: namely that statuary, architecture, and objects from the classical periods of Rome and Greece ought not to be pristine, glowing white marble, but painted in bright and varied colours. This argument was important to Semper because the presence of colour in architecture was one of his main pieces of evidence for the relationship between genitive art forms like textiles, and their collective descendent, architecture. Semper insisted that colour, imagery, and patterning on textiles translated into polichromy in wall-painting because textiles had been the original walls, and colourful wall-treatment, in Semper's view, was the vestige of that lineage.<sup>37</sup> For Semper, polichromy was the link between ancestral textiles and resulting architectural forms.

The adoption and development of Semper's arguments for polichromy in the approach to colour championed at the Bauhaus, and with which Albers was familiar, becomes evident.<sup>38</sup> Bauhaus colour theory indicated that certain colours receded, and others appeared to move forward toward the viewer, which, when applied to walls in the form of paint or wall hanging, gave the viewer spatial information about the space they inhabited.<sup>39</sup> In pictorial planes, whether in wall-painting specifically or otherwise, warm, light colours, like yellow, orange, white, and especially red, moved toward the viewer. Cool and dark colours, like blue, green, purple, and black moved away from the viewer.

Because colours had agency to move, the notion of contrast and tension arose. Students of the preliminary course learned the seven distinct types of colour contrast among them the contrast of 'pure' or primary colours, heightened by the inclusion of black and white.<sup>40</sup> I propose that Albers took up these notions and used them not only to align herself and her practice with Semper's ideas, but also to abstract matter, and in doing so, to make insubstantial, as it were, the gendered distinctions between architectural and textile practices. By abstracting matter, Albers works to break down the material separation between architecture and textiles: the stone and concrete of a building, and the cotton or jute of a wall hanging shimmer and fade into colour fields and sensory perception. The distinguishing features of architecture and textiles blur and dissolve, as do the gendered separation of these two art forms, therefore, if textiles are architecture are indistinguishable from one another, making distinctions between them as a 'male' practice (architecture) and a 'female' practice (textiles) becomes nonsensical.

<sup>37</sup> Semper, *Four Elements*, 37.

<sup>38</sup> This theory was taught in the preliminary course, and Albers completed that course in 1922.

<sup>39</sup> Johannes Itten, *Design and Form The Basic Course at the Bauhaus and Later* (New York: Van Nostrand Reinhold Company, 1975), 32, revised edition.

<sup>40</sup> Frank Whitford, *Bauhaus* (London: Thames and Hudson Limited, 1984), 106.

<sup>34</sup> Semper, quoted in Hvattum, *Historicism*, 72.

<sup>35</sup> Semper, *Stil*, 280.

<sup>36</sup> Semper, *Four Elements*, 37.

This kind of abstraction is present in her *Wall-hanging* from 1924 (Fig 1). This work adheres to a grid and uses a relatively limited colour palette. The bands of dark brown work to push the lighter fields forward, so that the lightest section, at the centre, seems to bulge towards us. The increasingly dark colour fields at the top and bottom of this hanging seem to move away from the viewer, while simultaneously, the lighter areas push forward. This play with colour works to establish implied lines that indicate a kind of shimmering, insubstantial visual field: these coloured bands pulsate with a rhythm that derives from the interaction of colour. As such, Albers engages with Bauhaus colour language to develop a dematerialised, abstracted space that appeals to a viewer's senses through colour and form. Here, space is shaped by colour and form rather than the material presence of the pliable textile plane.

The textiles examined here offer instances of Albers using colour to delineate spaces and to address the visceral experiences of her viewers. As such, these visceral, functional characteristics of textiles, as they were championed at the Bauhaus, deserve consideration. Wall hangings were used to distinguish spaces via colour. As with the Bauhaus approach to wall-painting, coloured textiles indicated the spatial relationships of walls by juxtaposing different colours, although in Albers' work, juxtapositions are contained in a single textile, while with paint the juxtapositions are on different wall planes, so that part of a room forms a composition.<sup>41</sup> This use of colour in conjunction with textile seems to harken back directly to the notion of polichromy developing out of the textile arts, as championed by Semper. These same considerations appear central to Albers' wall hangings.

Wall hangings, like those produced by Albers, also worked to show the viewer where the volume-bounding planes of a room were. If a textile hung against a wall, it drew attention to that plane through the juxtaposition or patterning of different colours, and thus the viewer was made more visually aware of a room's spatial boundaries.<sup>42</sup> Albers herself notes this use of interior textiles as she reminds her readers that 'large tapestries have for centuries been used as pictorial walls and rugs as pictorial floors, warming, but principally centralizing our attention. A beautiful view, the flickering of a fire, the play of water, flowers; all serve as such a focal point'.<sup>43</sup> As such, it would appear that interior spaces were perceived as spatial compositions that could be viewed as pictorial planes themselves. Likewise, if a textile were suspended from a ceiling it constituted its own planar boundary, which nevertheless was made apparent by a change in colour. This emphasis on planar boundaries dividing volume, and the focus on the viewer's sensory perception and comprehension of a space are two significant characteristics of Bauhaus architecture, but also, I argue, of Albers' textiles.

The examples investigated here suggest that this theoretical approach was based largely in Semper's notions of the four elements of architecture, as well as his ideas about festival-apparatus and the moment of dissolution. In all of these ideas, Semper asserts that textiles play a significant role: either as the ancestor of walls, or as objects which dissolve into sensory perception to achieve for the viewer a total experience, a total work of art, which appeals to the audience in a powerful and visceral way. We have seen instances of textiles, particularly those by Albers, working to recall Semper's ideas and act as catalysts for moments of critical intervention in interior spaces. As such, textiles are capable of communicating ideas about space. They are flexible enough, metaphorically and literally, to occupy more than one function within a space, and to transmit the sometimes complex theoretical concepts set out by Semper.

This examination indicates a few key points about Albers' practice in making wall hangings. Firstly, it indicates that she found alternative methods and media to express her interest in architectural and spatial concerns, despite the sometimes hostile environment she faced as a woman at the Bauhaus. This discussion also suggests that Albers, like other *Bauhäusler*, was aware of Semper and the theories he published in *Der Stil* and *Die Vier Elemente der Baukunst*, but that she adopted and adapted those theories to suit her own purposes: namely, making architecture with textiles. Finally, this engagement with Albers' work might lead us to re-consider the richness of the terms we commonly use to deal with her work. Her work seems to exist at the meeting-place between architecture and textiles, despite the fact that these categories often appear disparate. The phrase used to title these works, 'wall-hanging' also belies a complexity and richness that I think is well-suited to Albers' work. Like her textiles, this term appears at first glance to be straightforward and denotative, but in fact encompasses a variety of ideas, contexts, and meanings.

This richness indicates that Albers' woven works can exist between or outside of categories, and that they call into question the very existence and usefulness of that system of categorisation, which has become so familiar to us. Her weavings are both architecture and textile. Like the geometric, abstracted style of her wall hangings, the distinctions between architecture and textile seem to dematerialise the more we interact with them, leaving us with only a sensory experience of an enclosed space, one that appears to support and defy a linguistic structure. Thus, the title 'wall-hanging' itself becomes abstracted, allowing us to re-arrange the words to better suit our visceral reaction to these works: they are wall hangings, and they are hanging walls. The way in which her practices transcend these categories and terms suggests that it might be best to suspend our desire to categorise and name the works we see before us, and instead desire to experience the sensory spaces Albers builds for us.

41 Hans M. Wingler, *Das Bauhaus* (Schausberg: Verlag Gebr. Rasch & Co., 1962), 10.

42 Ibid..

43 Albers, "The Pliable Plane," <http://albersfoundation.org/teaching/anni-albers/texts/#tab4>.

**Jennifer Burgess**

Queen's University, Kingston, Ontario Canada



Jennifer Burgess graduated from Queen's University with a Master's degree in art history in 2015. Presently, she studies the textile work of Anni Albers, about which she presented at the Context and Meaning conference at Queen's University in 2015. Her other interests include craft theory, gender studies, semiotics, linguistics, children's literature, and fashion history. She aims to continue to engage with the relationship between Anni Albers' textiles and her published texts. She currently resides in Berlin.

E-mail: [13jmb3@queensu.ca](mailto:13jmb3@queensu.ca)

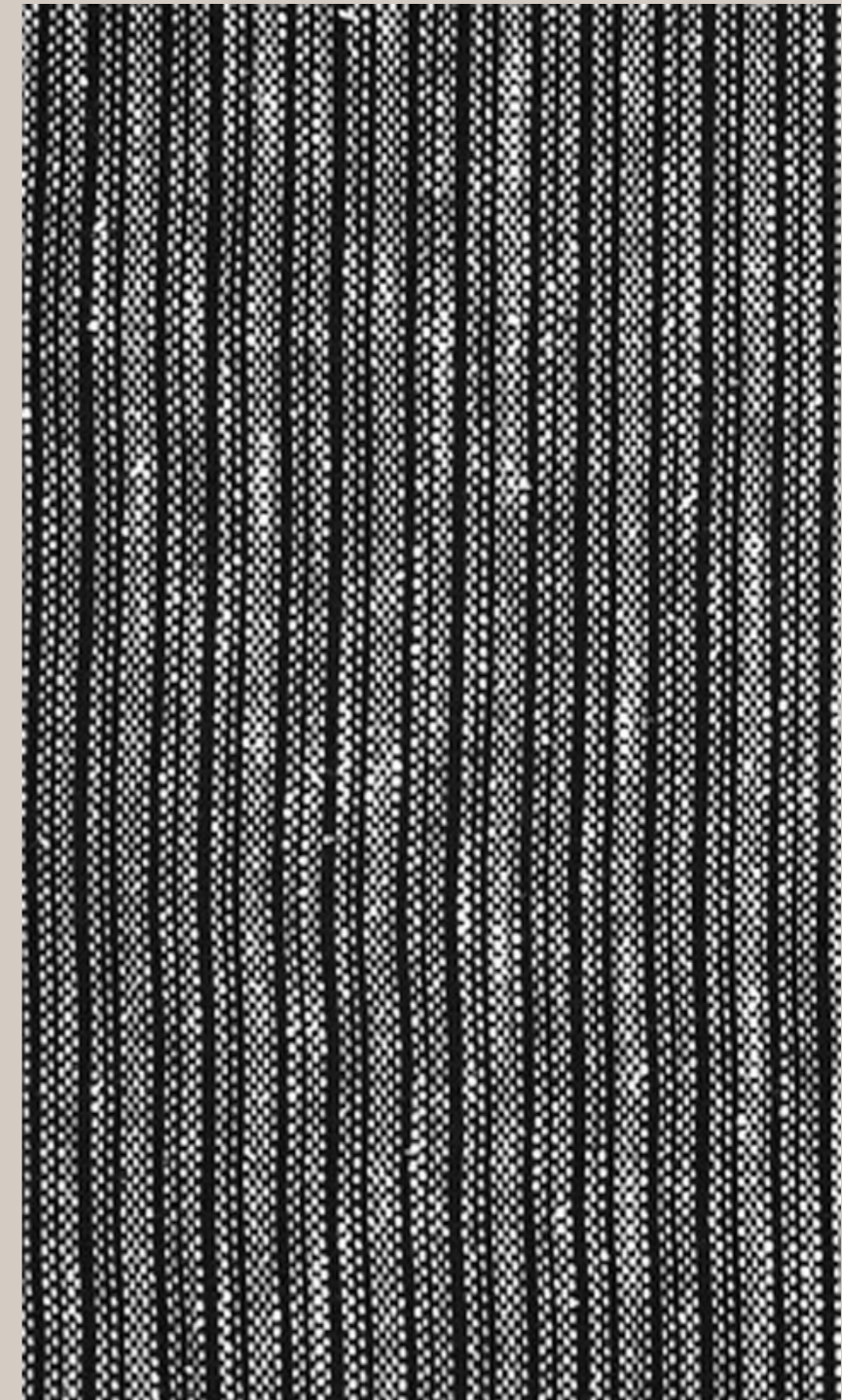

Roberta Spallone

Marco Vitali

# Interpreting Architectural Designs via Graphical Analysis and Digital Modeling

## Introduction

In this chapter, articles that deal with source surveys, graphical analysis, and digital modelling aimed at interpreting architectural designs are collected. These articles concern designs developed by architects during the 1930s that were designed not necessarily to be built, but were assumed as paradigms of their poetics of architecture, interlaced with a new way of life. The Modernist house is the subject of these case studies.

The drawing and the tools offered by the digital revolution in the field of architectural representation become a heuristic method of survey applied both to original design drawings and built architectures. The scholars, adopting this method, re-draw and, or, re-model the space and use the graphic model similar to scientists artificially reproducing a certain phenomenon in the laboratory. This method involves the identification and deconstruction of the building elements to retrace the ideative process by hypothesizing its phases. Digital models are the most useful database for collecting and synthesizing these analyses and interpretations.

Serafina Amoroso discovers and highlights elements of conceptual similarity between Eileen Gray's approach to space and architecture and the Japanese culture and way of life. The author discusses her hypotheses, referring to two case studies, the houses *E. 1027* and *Tempe à Pailla*, using perspective views of the interiors decomposed in several layers and frames, showing a moving point of view.

Starlight Vattano proposes a graphic reading of the *House of Dr. Nelken* (1932) by Helena Niemirska, made by graphic analysis and 3D modelling. This methodological approach allows the author to re-construct in three dimensions the modular grid and to search out the compositional criteria related to the sequence, development, and volumetric composition of spaces.

Giorgia Gaeta analyses Charlotte Perriand's unbuilt project for a *Maison du week-end* (1934) in which the architect faces the fundamental rules of human life in a minimum space and with the organisation of leisure. The digital model, intended as a hermeneutic tool, interprets the design process in order to deepen the compositional aspects of this flexible house to get formal and spatial values.

Vincenza Garofalo re-draws two built projects by Hana Kučerová Zaveská (Balling house, 1931, and a villa for her parents Olga and Maximilian Závěských in Dobrichovice, 1933–34). The graphic

analysis and construction of the 3D model are aimed at understanding the architectural organisms in a process of abstraction, synthesis, and choice of sign, which reveal the spatial dynamics, trying not to betray the original qualities of architecture.

Francesco Maggio focuses on the graphic reading of *Casa sul mare di Sicilia*, Lina Bo Bardi's unbuilt project (1940). The representation, conceived as a critical tool of analysis, is a bridge between ideal creation and construction, a medium for the verification of the project's intentions; the digital model is a virtual construction that simulates the materialisation of the project in a true, real, architectural 'body'.



## Eileen Gray's Architecture of Relationship: Materiality and Spatial Layering

This paper aims to offer a reading of Eileen Gray's work on the basis of a parallel that can be drawn between her critical interpretation of modern architecture and Japanese culture, about which she learnt through the intermediation of her fascination for and technical expertise in lacquer work, a technique that embodies a different way of understanding time, space and materiality. The western concepts related to the use of lineal perspective as both a method of representation and a spatial approach are replaced, in Japanese culture, by spatial layering. More specifically, there are three important key notions that may be used to trace a genealogy of Gray's concept of space, based on a sincere relationship with materials, on the subtle control of boundaries and on a spatial syntactic structure in which onion-like enveloping skins wrap and create a sensory responsive and multi-layered environment. They are *Ma* which means pause; *Rikyu nezumi* which refers to the ambivalence of shadows, and *Oku* or the profoundness of a multi-layered sense of space. Screens are space dividers; furniture dissolves the compactness of a room into an adaptable space-time continuum; sliding and folding elements are mobile partitions that, like a Japanese *fusuma*, suggest rather than delimit spaces.

Keywords: Modernity, Japan, materiality, layering, boundary, relationships

### Introduction: Resonances of Japan

In the early nineteenth century, Japanese works of both and applied art were already available in many European countries (Germany, France, and England). Cultural contacts were particularly intensified between 1848 and 1854, when a series of new treaty obligations encouraged trading initiatives between Japan and Europe. After the International Exhibition held in London in 1862 –‘one of the most important and influential showcases in the history of oriental art in the West’<sup>1</sup>– the *Exposition Universelle* in Paris in 1867 provided new opportunities to introduce Japanese art to the general public. In 1900 ‘Eileen and her mother went to Paris to see the great Universal Exhibition’<sup>2</sup> which was a turning point for Japanese art (above all for the ceramic industry). The Japanese government considered it ‘the most important exhibition since Vienna and invested a great deal of money in Japanese participation’.<sup>3</sup> In the course of the same exhibition, ‘Japanese crafts were criticized for their lack of progress’,<sup>4</sup> but, nevertheless, during the early nineteenth century, Japanese lacquer, textiles, ceramics, metal ware, ivory carvings were a source of fascination for the imagination of European artists and designers who were attempting to conciliate the negative effects that industrialisation had produced in the quality of design with the exciting possibilities offered by mass production.

Eileen Gray had many opportunities to become familiar with Japanese art by spending a lot of time in the Victoria and Albert Museum as a student of the Slade School of Fine Arts in London, which she entered in 1898 to study painting.

Visits to the museums were a must, not only for art students, but for anybody in good society [...]. Eileen [...] explored the museums on her own. One of her favourites was the South Kensington Museum, not far from her home, which by official order of the queen, became known as the

1 “Japonism (c.1854–1900),” in *Encyclopedia of Art History*, <http://www.visual-arts-cork.com/history-of-art/japonism.htm#japonism> (accessed July 3, 2017).

2 Peter Adam, *Eileen Gray: Architect/Designer: A Biography* (New York: Harry N. Abrams, Incorporated, 1987), 25.

3 Clare Pollard, *Master Potter of Meiji Japan: Makuzu Kōzan (1842–1916) and His Workshop* (New York: Oxford University Press, 2002), 80.

4 Ibid.

Victoria and Albert Museum in 1899. It was there that she first became interested in furniture and saw lacquer screens.<sup>5</sup>

But, after visiting the *Exposition Universelle* in Paris, fascinated by Art Nouveau (and, as suggested above, by Japanese art), she moved to Paris, where she met, in 1906, Seizo Sugawara, a Japanese artisan who taught her lacquer work. Once she had mastered lacquer, she decided to undertake original experiments in the use of new expressive codes by incising lines or embedding textures and other materials in the surfaces. Her skills in the lacquer technique, based on the overlapping of layers, were destined, according to the hypothesis suggested in this paper, to be fully transposed into the rhythms and spatial qualities of her architectural works.

In Japanese culture, the western concepts related to the use of lineal perspective as both a method of representation and a spatial approach are replaced by spatial layering. Hiroshige Ando's layering technique, which deeply influenced Europe's Impressionist movement, was based on Japanese pseudo-perspective<sup>6</sup> and replaced western perspective with a spatial concept based on sequences of planes having different qualities and values of visual permeability.

Japanese styles and influences met and intertwined with the destinies of some of the protagonists of Modern Movement (such as Bruno Taut, Charlotte Perriand,<sup>7</sup> Frank Lloyd Wright), generating an exchange of ideas which found expression in their works. It is therefore possible to detect modern affinities between traditional Japanese culture and Western modernity, pointing out the possibility of mutual resonances and influences. For instance, it can be stated that the *Ho-o-den* built in Chicago on the occasion of the International Exposition, opened on May 1<sup>st</sup> 1893, marked 'the beginning of Wright's direct architectural links with Japan',<sup>8</sup> although the Japanese pavilion –and its historic model in Japan, that is the original temple *Hō-ō-dō* or Phoenix Hall (1053)– was already familiar to local architects thanks to some articles published on national and international journals. Echoes of the influences exercised by Japanese architecture on Wright's work can be detected in the lateral and staggered approach to the entry of some of his Prairie House –the Ward W. Willits House (1902–03) for instance– or in the plan configuration of John Pew house (1940), in which a

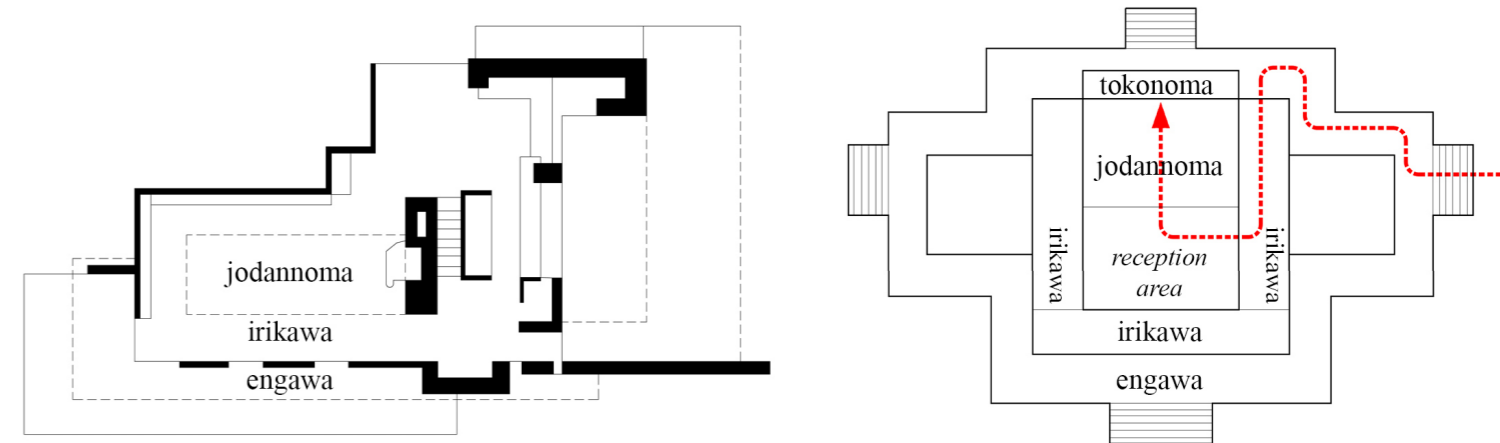

Fig. 1. Graphic processing, produced by the author, of the plan of the John C. Pew house by F. L. Wright (Madison, Wisconsin, 1940) and of the plan of the central hall of the Ho-o-den, showing (in a red dotted line) the staggered route to the *tokonoma* and its distinct spatial zones/layers.

The term *engawa* identifies 'The area beside or surrounding the straw matted floor of a room or veranda in Japanese dwellings' (see the *Glossary of Japanese terms* in Sfakiotaki, "Analysis of movement").

The term *irikawa* refers to spaces of circulation, which are the corridor-like spaces 'surrounding the main living space of the central hall' (see: Nute, *Frank Lloyd Wright*, 60).

The term *jodannoma* indicates the sitting area in front of the *tokonoma*.

The *tokonoma* is a built-in recessed space where art objects and flowers are usually displayed for artistic appreciation (Source: JAANUS Japanese Architecture and Art Net Users System, <http://www.aisf.or.jp/~jaanus/>).

Source of the original images: Nute, *Frank Lloyd Wright*, 59, 63, 64.

sort of spatial layering, very similar to that of a Japanese *Ho-o-den*, articulates the design of the interior spaces (Fig. 1).

[...] the most well-known architectural features of traditional Japanese house, which were highly praised by the leading figures of the 20th century modern movement, such as recessed alcove (*tokonoma*), built-in desk and shelves, wall-to-wall tatami mats, sliding screens to divide interior space (*fusuma*), wooden-lattice exterior sliding doors covered with translucent rice paper (*Shoji*) are the basic characteristics of Shoin Style of the Muromachi Period. (1333–1573).<sup>9</sup>

Other elements and concepts (which may be added to those listed above) –such as the modularity of

<sup>5</sup> Adam, *Eileen Gray*, 22.

<sup>6</sup> Thanks to new trade agreements, the flow of travelers and goods between Japan and the West increased enormously in the 1850s, thus triggering cross-cultural influences and exchanges between Japanese and Western artists. For this reason, Japanese pseudo-perspective itself was affected by Dutch influence as well (The Floating World of Ukiyo-E. Japan and the West: Artistic Cross-Fertilization, <https://www.loc.gov/exhibits/ukiyo-e/japan.html>, accessed August 30, 2017).

<sup>7</sup> Charlotte Perriand, from 1940 to 1942, during her first stay in Japan, worked at the department of Trade and Promotion of the Imperial Ministry of Commerce and Industry as consultant in industrial design in order to orient the production of furniture to be exported to the West. The same position had been occupied by the German architect Bruno Taut between 1933 and 1935. She documented her experiences in Japan in ten articles published from 1946 to 1957 and in her autobiography. See: Charlotte Perriand, *Une vie de creation* (Paris: Odile Jacob, 1998).

<sup>8</sup> Kevin Nute, *Frank Lloyd Wright and Japan: The Role of Traditional Japanese Art and Architecture in the Work of Frank Lloyd Wright* (New York: Van Nostrand Reinhold, 1993), 55.

<sup>9</sup> Murat Dündar, "Comparative Study on Conceptual Similarity and Differences between Traditional Houses of Japan and Turkey," *Intercultural Understanding*, 1 (2011), 18.

Japanese dwellings based on the *tatami* mat, the delicate asymmetry of their plan configurations,<sup>10</sup> flexibility, functionality, standardisation, lightness, transparency, etc.– can be traced back to traditional Japanese architecture.

Below, by way of a summary, is a brief overview of the above-mentioned features. The main purpose in listing them is to provide a general framework for exploring possible underlying elements of conceptual similarity between Gray's approach to space and architecture, on the one hand, and Japanese culture and way of life, on the other.

### (1) House as a Stage

According to Bruno Taut, who spent three and half years in Japan,<sup>11</sup> Japanese (domestic) architecture –which proceeds, through a progressive refinement process, from *Ise Shrine* (Shinto belief) and Tea culture (Zen belief)– reached a modern quality in the Katsura Detached Palace.<sup>12</sup> The fact that the traditional architecture of Japanese houses is a sort of evolution of religious buildings of Shinto implies that 'the house itself is a sacred place in a way where various kind of religious and custom rituals take place in time'.<sup>13</sup> Bruno Taut states that 'The Japanese house [...] is like a stage in an open-air theatre, the background of which, visible through the open wall, is nature'.<sup>14</sup> The metaphorical concept of Vacuum, as conceived by Taoism, seems to point in this same direction: 'only in vacuum lay the truly essential. The reality of a room, for instance, was to be found in the vacant space enclosed by the roof and walls, not in the roof and walls themselves. [...] Vacuum is all potent because all containing. In vacuum alone motion becomes possible'.<sup>15</sup>

### (2) Interior/Exterior Relations

The timber-framed structure of most traditional Japanese houses supports the load of the roof and only two sides of the building have walls (made up of grids of bamboos daubed with mud), the other sides (usually including the south one) being characterised by the presence of sliding partitions, doors or screens (usually made up of wood, straw and rice paper), which can be removed to face the garden. Views from the interior of a house towards its courtyard garden can thus be decomposed in several layers of both spatial and material qualities (Fig. 2).

### (3) Sense of Time

The presence of mobile furniture, sliding or folding partitions and cupboards, or storage units integrated in walls, stands for a special sense of time, with which Japanese culture –deeply influenced by Buddhism that limits the basic needs of everyday life– is permeated: the above-mentioned elements allow for different use of domestic spaces at different times of the day. This is also strongly linked to Taoism which, according to Chinese historians, can be considered as the "art of being in the world," for it deals with the present – ourselves. [...] The Present is [...] the legitimate sphere of the Relative. Relativity seeks Adjustment [...]. The art of life lies in a constant readjustment to our surroundings'.<sup>16</sup>

### (4) Spatial Layering and Threshold Conditions (Figs. 2 and 3)

In Japanese traditional architecture, elements such as spatial layering, the 'multipurpose usage of a room'<sup>17</sup> and the absence of defined and fixed boundaries (both between different rooms in the house and between interior and exterior) may be related, on the one hand, to the religious beliefs (Zen and Shinto) –which permeate the spiritual aspect of people's daily lives and advocate for simplicity– and, on the other hand, to some aspects of Japanese culture according to which familial atmosphere, rather than individuality, is much more important in the general asset of society, characterised, at various levels, by a parent-child relationship. Actually, in the Japanese language, there is no word for privacy: it is an importation from western culture.

Fig. 2. View towards the courtyard garden from the interior of a traditional Japanese urban residential building.

Graphic, processing produced by the author, showing the decomposition of space in several spatial layers.

Source of the original photograph: Mira Locher, Kengo Kuma, and Ben Simmons, *Traditional Japanese Architecture: An Exploration of Elements and Forms* (Tokyo: Tuttle, 2010).

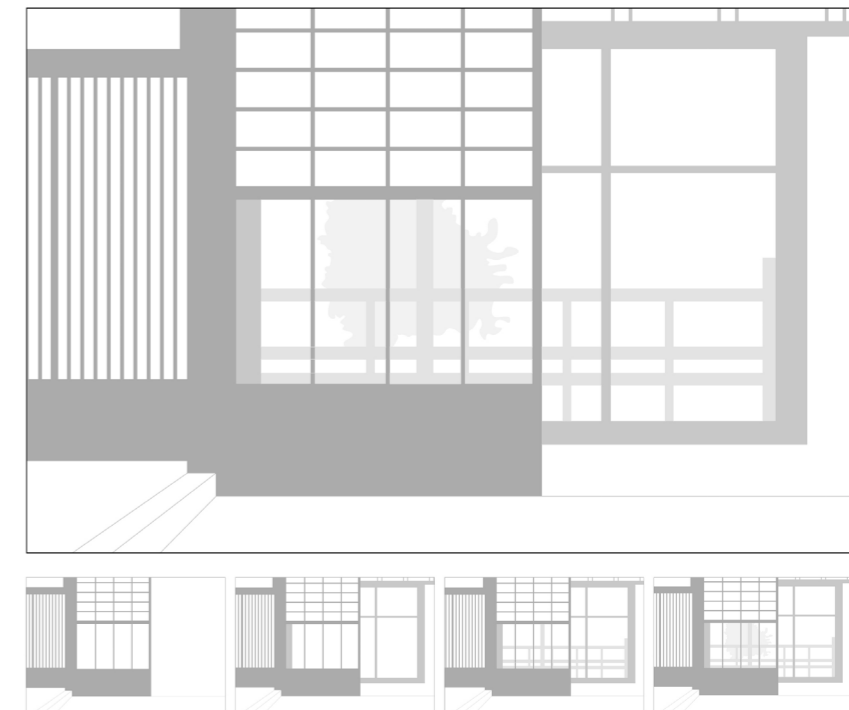

<sup>16</sup> Okakura, *The Book of Tea*, 58.

<sup>17</sup> Dünder, "Comparative Study," 20.

<sup>10</sup> Fifteenth-seventeenth century Japanese architecture features examples of asymmetric (though controlled by modular layouts) plan configurations, as exemplified by the asymmetrical placement of the pavilions of the imperial villa of Katsura (1579–1673). See: John F. Pile, *A History of Interior Design* (London: Laurence King Publishing, 2005), 96.

<sup>11</sup> See: Bruno Taut and Hideo Shinoda, *Houses and People of Japan* (Tokyo: Sanseido Co., 1958).

<sup>12</sup> See: Dünder, "Comparative Study," 17–23.

<sup>13</sup> Dünder, "Comparative Study," 20.

<sup>14</sup> Taut and Shinoda, *Houses and People*, 191.

<sup>15</sup> Kakuzo Okakura, *The Book of Tea* (London and New York: G. P. Putnam's Sons, 1906), 59–60.

### (5) Materiality (Fig. 3)

Most traditional Japanese houses are timber-framed - the tactile and material qualities of their pillars are conceived with both spatial and decorative purposes and in spite of the simple aspect of a Japanese room, many features (such as ornamental openings, wood finishes, either in their natural state or richly lacquered) were displayed for decorative purpose. But since 'the beauty of a Japanese room depends on a variation of shadows, heavy shadows against light shadows –it has nothing else',<sup>18</sup> layering and materiality together with a 'sensitive use of shadow and light'<sup>19</sup> – are constitutive/formative spatial methods and creative design strategies rather than mere decorative mechanisms.

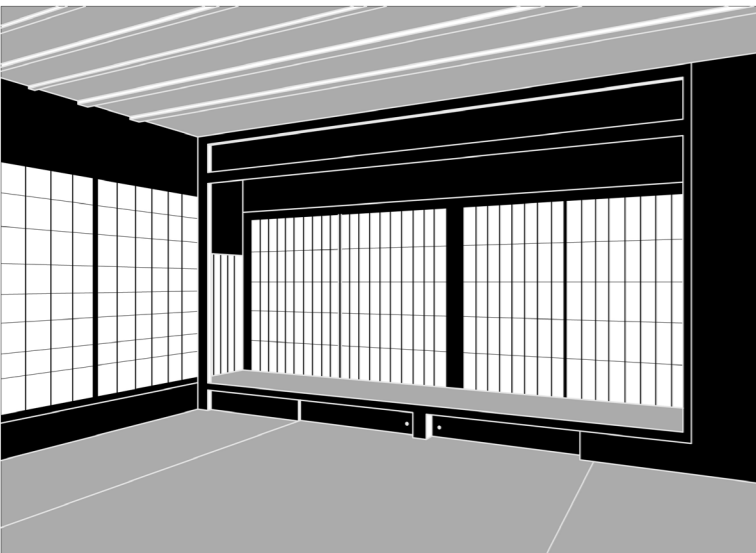

Fig. 3. Interior view of a traditional Japanese residential building.

Graphic processing, produced by the author, showing the decomposition of space in several spatial layers and the creative and decorative use of the natural qualities of material.

Horizontal spatial layers are shown in light gray (floors covered with tatami mats and wood board-and-batten ceilings). Vertical spatial layers are shown in black (sliding paper and wood screens, the shutters of a storage space under the staircase).

Source of the original photograph: Bruno Taut and José Manuel García Roig, *La casa y la vida japonesas* (Madrid: Fundación Caja de Arquitectos, 2007), 184.

### Eileen Gray's Materiality and Spatial Layering

When Eileen Gray started her career with lacquer furnishings in the 1910s, she was an artisan, working materials, rather than an architect. There is no novelty in this phenomenon, since Loos, Mies and Le Corbusier, in their youth, had apprenticed as artisans as well.

Similarly, there is no novelty in conceiving interiors and domestic atmosphere as an extension and completion of the spirit of their inhabitants. It was a contemporary approach in Art Nouveau design in Paris at that time, thanks to Dr Jean-Martin Charcot (a precursor to Freud), who, in the 1880s, demonstrated, through the therapeutic hypnosis experiences of his patients, that the

18 Jun'ichirō Tanizaki, *In Praise of Shadows* (New Haven, Conn: Leete's Island Books, 1977), 18.

19 Tanizaki, *In Praise of Shadows*, 20.

external qualities of an environment can influence thoughts, feelings, actions, human behaviours, and emotional reactions. This fact implied the dissolution (based on scientific authority) of the boundaries between the inside and the outside. With such authoritative scientific support, decorative artists in France at the end of the nineteenth century began to take seriously their therapeutic responsibility of redesigning domestic space.

Within this cultural framework, the personality of Eileen Gray was a more complex and ambiguous mixture. It is almost impossible to establish to what extent Japanese culture influenced Gray's approach to architecture and design, because the elements of her architecture can be drawn from different sources and influences.

Her lacquer work and interior design schemes from the 1910s and early 1920s, for example [...] the Monte Carlo room that she showed at the XIV Salon des Artistes Décorateurs in 1923 [...], contain elements of De Stijl-like, cubist-inspired abstraction [...] which seem to be overwhelmed by the richly textured sensuality of materials.<sup>20</sup>

Gray's way of conceiving space might also be seen as an attempt to re-formulate the relationship between human body and its environment, which, on the one hand, has parallels in Oskar Schlemmer's engagement with the social and artistic possibilities of this relationship, and, on the other, reminds one of 'Judith Butler's bio-political conception according to which: "[Bodies] themselves are modalities of power...productive and performative'.<sup>21</sup> Schlemmer's interest in the artistic and social implications of the materiality of the body is 'a reflection of Bauhaus formalism, which centered around the study of the materiality of a medium before going into theoretical discussion'.<sup>22</sup> Similarly, Gray's approach to materiality can be read as a means to communicate her way of understanding space, according to which, as suggested by Susan Hedges,<sup>23</sup> the sensuous textures of the built environment and elements and the participating presence of users' bodies and of their (domestic) performances, are the main components that, interfering and interacting with each other, activate space.

Gray's approach to modernity is something completely innovative, non-canonical and non-heroic. It is a kind of critical commentary on the Modern Movement itself, on its abstract formula and on the cold calculations<sup>24</sup> which modern architecture seemed to derive from.

Her architecture of relationships, based on the subtle and delicate control of boundaries, marks a

20 Jasmine Rault, *Eileen Gray and the Design of Sapphic Modernity: Staying In* (Farnham, Surrey: Ashgate, 2011), 17.

21 Beau Rhee, "Living Matter" (Master Thesis, La haute école d'art et de design - Genève, 2012), 38.

22 Rhee, "Living Matter," 41.

23 See: Susan Hedges, "Architectural Notation and the Body Condition: Tracking the Dance of E1027" (paper presented at the conference held at the University of Brighton, Brighton, England, July 2–4, 2009).

24 See: Eileen Gray, "Maison en bord de mer," in *L'Architecture Vivante* (1929). Gray's essay, "From Eclecticism to Doubt" has been translated and reprinted as an appendix to: Caroline Constant, *Eileen Gray* (London: Phaidon Press, 2000), 238–245.

return to a sincere relationship with materials, to an architecture that should be bodily experienced (both at an individual and at a social level).

As bodies are always mobilized in space and time, architecture is also a natural point of inquiry into an artistic and cultural treatment of space – social and political – and an inquiry into the very details of the process of living itself. [...] a body has no movement or life without space, and space has no reason to be constructed without movement or life of the human body.<sup>25</sup>

Architectural elements are, in general, not only space dividers, but rather a built reflection of a social and gendered order and deeply influenced, in the case of Japanese traditional architecture, by Buddhism and Shintoism.<sup>26</sup> Although the exploration of the possible spatial and temporal implications of Butler's theorisation of performativity (as mentioned above), addressed to architecture, is not the focus of this paper, it cannot be ignored that (architectural) space as well as sex and gender is the result of representations, cultural constructs and productions, whose essential and ontological dimension has been replaced by a performative conception. This latter has entered the contemporary architectural discourse because architecture itself 'is understood as a process rather than as an object'.<sup>27</sup> Precisely for this reason, Bonnevier's analysis of Gray's architecture in *E. 1027* follows an approach especially focused on gender and sexuality, according to which the house 'is interpreted as a built suggestion and a critique of heteronormative, male-dominated architectures'.<sup>28</sup>

This paper aims at offering a reading of Gray's work within the framework of a gap she herself produced, making room for an innovative range of interpretations.

For this purpose, the parallel, suggested by this paper, between Japanese culture and Gray's

<sup>25</sup> Rhee, "Living Matter," 32–33.

<sup>26</sup> As regards gender issues, contrary to what one would expect, gender segregation in Japanese domestic architecture was not as notable as in other eastern culture (such as in Korea, because of the influence of Neo-Confucian ideology).

<sup>27</sup> Jan Smitheram and Ian Woodcock, "Knowing Occupations: The Emetics of Very Small Houses" (paper presented at the conference held at the University of Brighton, Brighton, England, July 2–4, 2009), 3.

<sup>28</sup> Katarina Bonnevier, *Behind Straight Curtains: Towards a Queer Feminist Theory of Architecture* (Stockholm: Axl Books, 2007), 30. The fact that Eileen Gray is always deeply concerned with the preservation of her privacy, above all in *Tempe à Pailla*, reveals a design approach focused on the interior rather than on the exterior of the building. This issue, together with the absence of spatial hierarchies and above all of those spatial roles usually associated to a gendered use of domestic space –which can be detected in the fact that she termed 'her workroom a "boudoir-studio," merging the historically gendered spaces of boudoir and study into a single entity' (see: Constant, *Eileen Gray*, 107)– could be read as an attempt to re-interpret the feminisation of domestic space re-signifying it, since the domestic space was the official setting that a patriarchal society and tradition had assigned to women. This was, thus a reaction against and subversion of the sexual and gender associations usually linked to these spaces, in opposition to the masculinised modernist design strategy, based on a strongly hierarchical arrangement of space, according to which an interior should open centrifugally to the exterior. As an exception to the above mentioned elements, and perhaps because she could count on a maid's presence that prevented her to inhabit this space herself, the kitchen of the E1027 is the least suitable room to express her bodily concern with space.

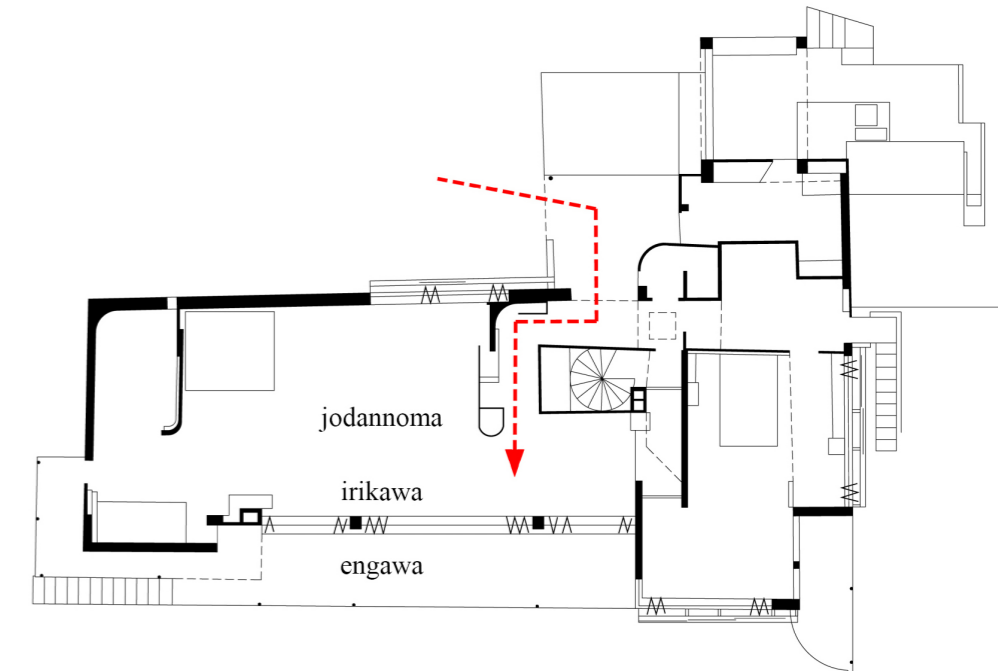

Fig. 4. Graphic processing, produced by the author, of the floor plan of the upper floor of *E. 1027*, drawing parallels with the spatial layering of the central hall of the *Ho-o-den* (see Fig. 1).

Shown in a red dashed line, the entry sequence, which requires three turns, recalls the zigzag movement of the staggered route to the *tokonoma* in the central hall of the *Ho-o-den*.

Source of the original image: Stefan Hecker and Christian F. Müller, *Eileen Gray: Works and Projects* (Barcelona: Gustavo Gili, 1993), 108.

approach to space can be introduced by referring to three important concepts: *Ma*, *Rikyu nezumi* and *Oku*.

The first concept, *Ma*, means pause intended as both a distance in space (a space in-between other spaces), and an interval of time (between phenomena and events, that is a kind of gap or silent space). It is strictly connected to Taoist and Buddhist tradition according to which a man is considered as an integral part of nature (but not as its centre, which is opposite to the anthropocentric perspective of Western culture). In these terms, within the multi-layered spatial structure of Japanese architecture and its conception of architectural space and nature as a continuum, humans are part of the composition, an extra layer.

The concept of *Ma* can acquire an outstanding significance as a key concept to fully understand and appreciate the gradualness of physical movements into and/or through Gray's houses, which usually require, from the entrance, a series of compulsory turns (Fig. 4), each time revealing a screened view. A gradual penetration of interior space, as well, is obtained by delaying, both in space and time, the progressive approach and access to the living room from the outside. This approach resonates with the above-mentioned *ma* concept, which structures Japanese way of thinking and acting: space becomes significant through the mediation of time<sup>29</sup> that is to say through the actions and the rituals that take place in it.

<sup>29</sup> See: Keiko Elena Saito, "Arquitectura y ambiente: Una mirada renovada sobre los conceptos Ku, Oku y Ma," *Kokoro: Revista para la difusión de la cultura japonesa* 5, no. 14 (2014), 8.

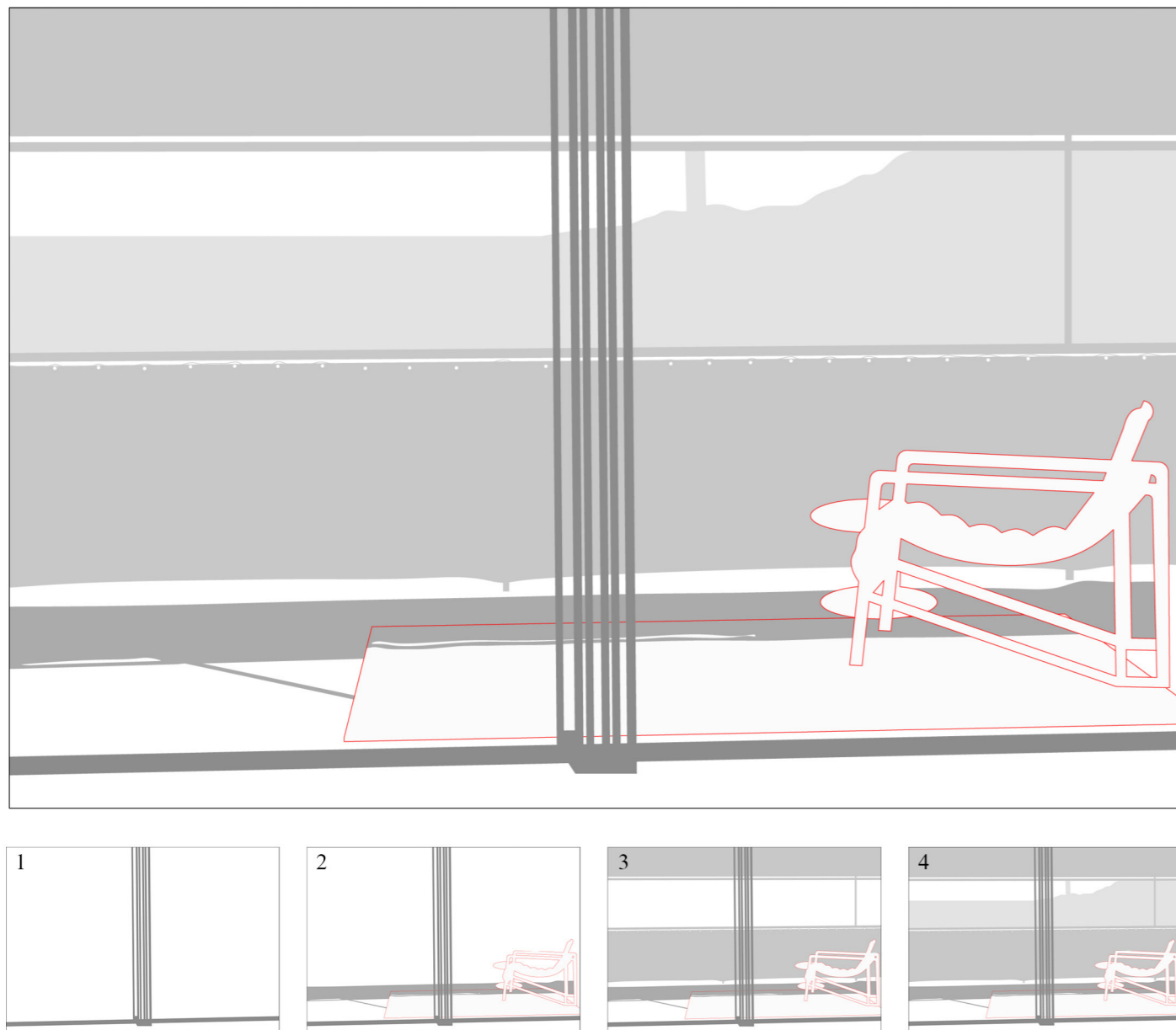

Fig. 5. E.1027, view from the living room towards the terrace (graphic processing produced by the author).  
 Spatial layering: **1** the frame of the patented paravent-window; **2** the materiality of furniture (her Transat chair and circular table) and the complimentary pattern produced by the shadow cast by the canopy, which break the tension between (inhabited) space and (its flattened) image; **3** the shade canopy; **4** the surroundings.  
 Source of the original photograph: Peter Adam, *Eileen Gray: Her Life and Work* (London: Thames & Hudson, 2009), 200–201.

The second concept is *Rikyu nezumi* (philosophy of grey) that, according to the definition supplied by Kisho Kurokawa,<sup>30</sup> refers to the darkness and shadows that, dissolving architectural elements, turning their three-dimensional character into a sequence of flat elements. Space is not experienced from a single point of view, but rather from a moving visual point of perspective that dissolves the sculptural, three-dimensional effects of a strong and defining shading (which is synonymous with a space of single, unambiguous meanings) into a two-dimensional world of plane elements, blurring shades and multiple meanings (Fig. 5).

The third concept is *oku* (innermost area), which refers to the high density and profoundness of a multiple layered sense of space. *Oku* is the innermost space in a sequence of spaces, which embodies the Japanese sense of vacuum, intended as the interior and central space of a nested spatial system. The *oku* concept is the opposite of what center means in western culture, since it indicates a sense of hidden and invisible deepness.

These three key notions may be used to trace a genealogy of Gray's concept of space, which inherently includes time and space as qualitative connotations. The spatial syntactic structure of her houses is based on a spatial strategy that occupies an in-between and ambiguous position between two different ways of shaping (architectural) space: by addition of parts, from inside out (centrifugal space), and by subtraction of (unnecessary) parts, from the whole to the part (centripetal space). Gray's distinctive and personal attitude towards space engages in dialogue with the main principles of the De Stijl movement, whose spaces, made up of individual elements could be perceived both as wholes and as assemblages of autonomous parts.<sup>31</sup> At the same time, the ambiguity and ambivalence of Gray's spatial concept finds resonance in the principle of duality that underlies Japanese daily life, deriving from Lao Tzu's teaching about the dynamically balanced presence, within space, of both inside and outside.<sup>32</sup> Her houses are structured as sequences of interdependent spaces, whose functional multiplicity breaks down 'the conventional notion of the room as a singular spatial entity'<sup>33</sup> without challenging intimacy and privacy, thanks to 'her conception of the furniture as a series of extrusions from the wall'<sup>34</sup> that adapt to individual requirements.

30 See: Matteo Belfiore, "On Japanese spatial layering," *Le Carré Bleu: Fuelle internationale d'architecture* no. 2, (2012), [http://www.lecarrebleu.eu/allegati/LCB%202-2012\\_INGLESE\\_.pdf](http://www.lecarrebleu.eu/allegati/LCB%202-2012_INGLESE_.pdf) (accessed July 3, 2017).

31 See: Anne-Catrin Schultz, "The Process of Stratification in the Work of Carlo Scarpa" (Doctoral Dissertation, Faculty of Architecture and Urban Planning, Universität Stuttgart, 1999), 98 and 111, <http://elib.uni-stuttgart.de/opus/volltexte/1999/514/> (accessed July 3, 2017).

32 See: Schultz, *The process of stratification*, 99. Actually, a centrifugal conception of space lies behind the traditional Japanese house, but its extroverted character –according to which nature is considered as the prolongation of interior space and the plan of the house proceeds from interior towards exterior– refers mainly to its relationship with its immediate environment, that is to say with its garden (rather than with its outdoors).

33 Constant, *Eileen Gray*, 105.

34 Ibid.

### E. 1027 (1928): Layering as Merging Spaces

*E. 1027* is a portrait of its author and creator, a total work of art, in which furnishings, built-ins, colours, lights, and materials are totally conceived 'for the well-being of its inhabitants'.<sup>35</sup> Stencilled texts and inscriptions –in the form of invitations or injunctions, such as *entrez lentement* or *invitation au voyage*– seem to underscore 'the limited temporality of modern conditions of dwelling',<sup>36</sup> thus resonating with the sense of time of Japanese culture. As Caroline Constant affirms, Gray's conception of (domestic) space is 'a fertile combination of the sensual and the commonsensical'.<sup>37</sup> Sliding and folding elements are mobile partitions that, like a Japanese *fusuma*, suggest rather than delimit spaces, creating a living environment endowed with a sense of spatial flexibility in which even rugs and carpets define spatial entities. Private and public areas/zones can be identified in the way people circulate in the spaces of the house: the entrance provides a transitional space (Fig. 4), whose extension includes the corridor-like spaces of circulation (*irikawa*) surrounding the living room (*jodannoma*); this latter is conceived as a guest-reception room and visitors are not allowed any further. In spite of this fact, thanks to the multiple spatial devices –the (even mentally) sliding layers of the openings, built-in furniture, pivoted elements, and folding screens– one gets the impression of a spatial continuum. Much in line with the spatial zones of a traditional Japanese building (Fig. 1), the veranda (*engawa*) plays the role of an intermediate space between inside and outside. The merging and blurring of distinctions between furniture and architecture in Gray's house –since 'one element seemingly merges into another',<sup>38</sup> as suggested by Constant– seems to recall the multipurpose rooms with small furniture in traditional Japanese (domestic and religious) architecture. Similarly, in Gray's houses furniture is very often situated along the boundaries of two different rooms, ambiguously delimiting and mediating the flowing of space between each other, acting as interstitial spaces that take into account the changing nature of human life and its incompleteness. Even contrasting textures and different conditions of light and shadow generate different spatial gradations, focused on inside intimacy, materiality and a delicate (and seasonal) contact with the outside (Fig. 5).

This approach to space doesn't create a sculptural architecture but rather an *architecture of relationships* according to Kengo Kuma's definition.<sup>39</sup> The 'surfaces of the walls, the bed, the mirrors in the bathroom, they have a dimensionality and a deep connectivity to the daily movements of life'.<sup>40</sup> This issue recalls Taut's above-mentioned definition of Japanese domestic space as a stage. The term 'enactment' –which constitutes one of the core elements of Katarina Bonnevier's interpretation

of Gray's architecture in the *E. 1027*<sup>41</sup> – seems to point in this direction as well (in spite of the fact that the starting premises are of a different nature), since it 'includes the act and brings into play the interconnectedness of material container, the setting, the deeds and the actors'.<sup>42</sup>

*E. 1027* is a 'house to be experienced'.<sup>43</sup> Gray's approach to architecture and design can be defined as *usage-action-gesture* oriented:<sup>44</sup> space and architecture 'seemed to take shape around the furniture and the way its occupants would move in physical space'.<sup>45</sup> Like an 'orbital planetary movement',<sup>46</sup> the gestures and movements that allow the usage of space around hinging, floating, pleating, folding/unfolding and multi-layered pieces of furniture, speaks about a fluid conception of space imbued with a sense of temporality, which seems to have resonances with Japanese culture. The living room was characterised by the presence of different spatial and use densities. Gathering corners around the music and dining area, for example, originally implied a non-conventional arrangement and layout of the furniture themselves.<sup>47</sup> The centre of the living space was the divan, a reinterpretation of the traditional Provençal divan that was the usual place for sitting or lying down during the hottest hours of the day, to take a siesta or simply relax. According to Bonnevier, the living-room in *E. 1027* is 'a multifunctional space for pleasure, rest, studies, business meetings and parties'.<sup>48</sup>

### Tempe à Paillasson (1932–34): Layering as Folding/Unfolding Spaces

As regards *Tempe à Paillasson*, 'Gray's extremely private house'<sup>49</sup> which 'was conceived, well before it was designed, for privacy',<sup>50</sup> it can be considered as a further step in the development of her

41 The other one being *queerness*. See: Bonnevier, *Behind Straight Curtains*.

42 Bonnevier, *Behind Straight Curtains*, 16.

43 Anthony Flint, "Restoring Eileen Gray's E-1027," *Architect: The Journal of the American Institute of Architects*, August 12, 2015, [http://www.architectmagazine.com/design/restoring-eileen-grays-e-1027\\_o](http://www.architectmagazine.com/design/restoring-eileen-grays-e-1027_o) (accessed 20 November 2015).

44 See: Rhee, "Living Matter."

45 Flint, "Restoring Eileen Gray's E-1027."

46 Rhee, "Living Matter," 55.

47 The racy murals Le Corbusier painted in the house deeply altered the spatial settings and layout of the living room. Many experts agree about the fact that Gray's interiors and Le Corbusier's murals are incompatible (although, as Caroline Constant has pointed out, probably the house has survived until the present day thanks to their presence). This should be sufficient to remove and place them into a museum, reconstructing the original spatial layout, but due to the classification of the paintings as a *Monument Historique* under the French Law, it is almost impossible to reach this decision; consequently, some expert has suggested to re-create the original setting with the help of a computer, that is to say by means of visual rendering that can at least contribute to form an opinion.

48 Bonnevier, *Behind Straight Curtains*, 39.

49 Rault, *Eileen Gray*, 20.

50 Rault, *Eileen Gray*, 137.

35 Constant, *Eileen Gray*, 93.

36 Constant, *Eileen Gray*, 95.

37 Constant, *Eileen Gray*, 93.

38 Constant, *Eileen Gray*, 106.

39 See: Belfiore, "On Japanese spatial layering."

40 Rhee, "Living Matter," 50.

'critique of dogmatic functionalism'.<sup>51</sup>

'In contrast to E. 1027, where entertaining was a priority, Gray conceived of her house at Castellar as a place of solitude and retreat'.<sup>52</sup>

There is no doubt that privacy is the central design principle of *Tempe à Pailla*; her strategies in purchasing a large quantity of land were more likely to be oriented to secure her privacy by regulating inward views rather than (or, at least, as well as) providing uninterrupted outward views towards the natural surroundings of the house. Gray's spatial planning and 'architectural renderings of private space'<sup>53</sup> aim at engaging the user with space and its elements, incorporating sequences of multiple (both horizontal and vertical) layers into the experience of domestic space (including natural elements –such as the sun and, consequently, the shadows cast by trees, their foliage, and the hill itself– which act as extra layers and filters) (Fig.6).

Visual clarity as advocated by Le Corbusier, is totally absent here: the reductive total view cannot explain and represent the complexity of an almost incommunicable way of conceiving space, made up of visual ambiguities and physical obstructions.

*Tempe à Pailla* is made up of disconnected spaces and circumscribed enclosures, each one endowed with an autonomous identity relying on their haptic sensuality.

In general, Gray's photographs emphasise 'the privacy and isolation of the house [...]. As Caroline Constant explains, Gray "[r]einforc[ed] the site's natural isolation, [and] devised a dense system of architectural layers to insulate herself against any potential intrusions on her privacy"<sup>54</sup> Gray took her own photographs (Fig. 6) of her two southern French houses afterwards, to record her design ideas in the built results, which demonstrate 'her position in the constructed work [aiming at recording] the way in which building elements were layered with space'.<sup>55</sup> Photographs are used to catch fragments of time, moments and temporary effects of light and activity: '

In the reality which her photographs recorded, the furniture and the enclosing wall elements generated layers of subsidiary space within the flow of the rooms'.<sup>56</sup> Her sensory responsive design solutions, together with the '[...] shadows and emanations of light [...] locate [the user] not only in space but in time'.<sup>57</sup>

Being articulated in individual parts, the main feature of this domestic space is the spatial sequence

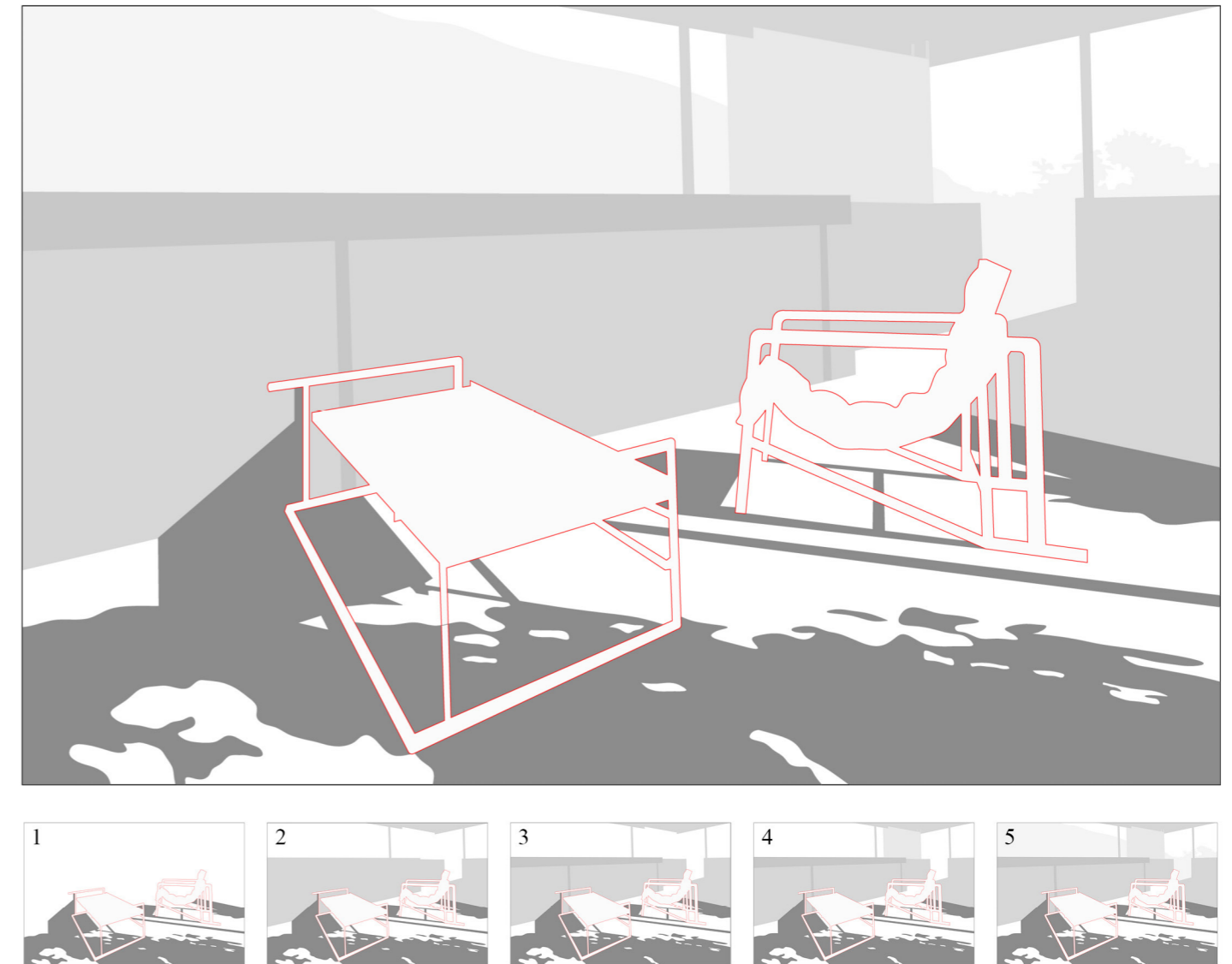

Fig. 6. *Tempe à Pailla*, view towards the mountains from the terrace (graphic processing, produced by the author, of a photograph taken by Eileen Gray in 1934).

Spatial layering: **1** the materiality of furniture (her Transat chair and adjustable table) and the complimentary pattern produced by the shadow cast by the foliage of the trees, which break the tension between (inhabited) space and (its flattened) image; **2** the architectural frame; **3** the complimentary pattern produced by the shadow cast by architectural elements (columns and canopy); **4** the sliding shutters; **5** the surroundings.

Source of the original photograph: Hecker and Müller, *Eileen Gray*, 132.

51 Constant, *Eileen Gray*, 145.

52 Constant, *Eileen Gray*, 146.

53 Rault, *Eileen Gray*, 1.

54 Rault, *Eileen Gray*, 136–137.

55 Andrew Higgott and Timothy Wray, *Camera Constructs: Photography, Architecture and The Modern City* (Burlington: Ashgate Pub. Co., 2012), 277.

56 Higgott and Wray, *Camera Constructs*, 277.

57 Ibid.

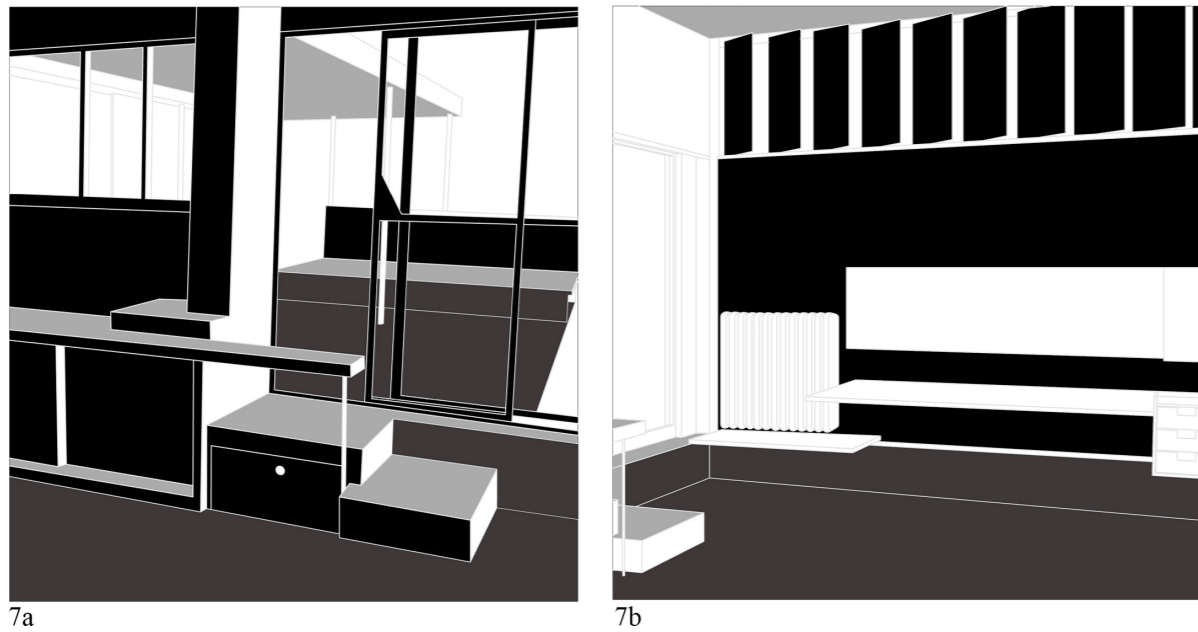

Fig. 7. Tempe à Pailla, vertical (shown in black) and horizontal (shown in light gray) spatial layering (graphic processing produced by the author).

**7a** View from the living room to the terrace, with fireplace, chimney, extended shelf and built-in storage space under the staircase; the white tile floor (shown in a different tonality of gray) of the terrace folds up against the platform of the sunbed.

**7b** View from the study side of living room (about 1950) to terrace; the white tile floor (shown in a different tonality of gray) folds up against the wall, under the built-in desk, creating a circumscribed space, in which a densification of layers generates awareness of a tridimensional, haptic and visual spatial environment..

Source of the original photographs: **7a** Hecker and Müller, *Eileen Gray*, 131; **7b** Hecker and Müller, *Eileen Gray*, 137.

of single volumes, each one conceived as a spatial entity and each one haptically recognisable. Gray challenges the awareness of boundary conditions by varying the floor levels of the rooms and accommodating storage units in the ceilings (thus transforming their functional scopes), and by expanding, folding and unfolding space by means of both vertical and horizontal layering (Fig. 7) that activates circumscribed haptic and visual spatial environments, she rejects the spatial idea of the free plan.

## Conclusions

The significance of Gray's houses *E. 1027* and *Tempe à Pailla* 'lies more in the questions they raise than the solutions they pose'.<sup>58</sup>

<sup>58</sup> Constant, *Eileen Gray*, 163.

Gray's built-in furnishings, folding steps, pivoting storage compartments, concealing or doubling functions, continuously provoke semantic shifts: '[...] meaning is created in the process of making'.<sup>59</sup> Architecture is not treated as if it were a neutral framework, but rather as a merging and lively spatial environment that people –by living and using the spatial devices (such as furniture and other mechanisms that act as spatial condensers) they are provided with– fill with meanings and activate. It is the opposite to the *promenade architecturale* in which the user is a spectator, the result of the visual abstraction in design and architecture. The fact that Gray's interiors are in general multi-layered, made up of heterogeneous elements, implies that the only possible way to interpret them is from within, entering into them, perceiving them in time and space, which requires a multi-focal and non-hierarchical approach.<sup>60</sup> This multi-layered conception of space obliterates the traditional figure-ground relationships and goes beyond the typical architectural dichotomies (of introverted versus extroverted space, of centrifugal versus centripetal design strategies), creating a more complex and wider range of spatial possibilities (such as visual occlusion, simultaneous presence of revealing and concealing surfaces, transparency and opacity, etc.) in which the human body is an active agent that continuously renegotiates spatial boundaries.

According to Gray, the user is the real and concrete (synesthetic) protagonist of domestic space and of the unfolding of its potentialities. Space, furniture and users are definitely treated as a whole. Consequently, the main scope of the new reading of Eileen Gray's work, which this paper is suggesting, through the lenses of Japanese culture, is to demonstrate that a new way of understanding Modernity is possible, if Modernity is considered imaginatively, that is to say as an active component in the design process.

<sup>59</sup> Bonnevier, *Behind Straight Curtains*, 84.

<sup>60</sup> See: Despina Sfakiotaki, "Analysis of Movement in Sequential Space: Perceiving the Traditional Japanese Tea and Stroll Garden" (Academic Dissertation, Faculty of Technology, University of Oulu, 8 April 2005), 48.

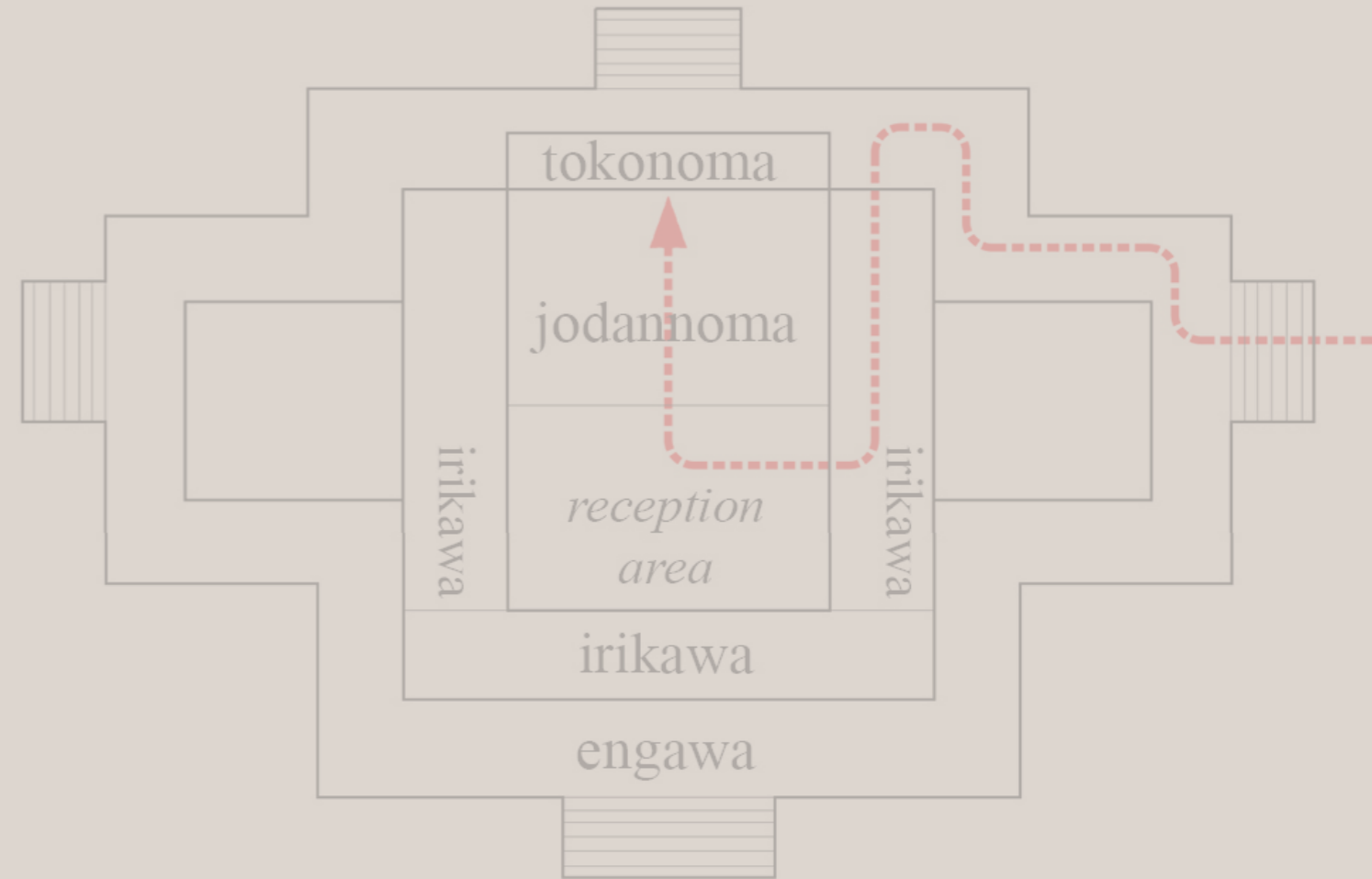

**Serafina Amoroso**

University of Florence, DIDA - School of Architecture

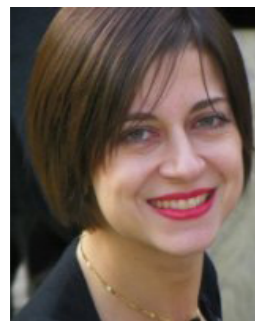

Serafina Amoroso is an architect who currently works as a lecturer under contract in a second-year Architectural Design Studio at the School of Architecture of Florence and as a teacher of Art History and Drawing at a secondary school. She holds a PhD degree in Architectural and Urban Design and got a Master degree in Advanced Architectural Design from the ETSAM in Madrid, where her personal and academic interests began to focus on gender perspectives and their relationship with space and education. In 2014 she was selected to participate in the Visiting Teacher's Programme of the Architectural Association in London.

E-mail: [serafina.amoroso@hotmail.it](mailto:serafina.amoroso@hotmail.it); [serafina.amoroso@unifi.it](mailto:serafina.amoroso@unifi.it)

## Helena Niemirowska Syrkus: Graphic Analysis of the 'House of Dr Nelken in Warsaw'

In 1920s and 1930s, Warsaw was becoming one of the hubs of propagation of the new architecture, thanks to the geographical contiguity with the Weimar Republic, it encouraged the formation of young minds through a blending of architecture, art and music. In this cultural context, a young Helena Niemirowska Syrkus supported the idea that urban planning and architecture, conceived as art forms, had to target the definition of a language capable of expressing the great revolutions achieved in the social, economic and political life of that time. According to Helena Niemirowska, who shared the avant-garde thesis, to become an artist the modern architect had to become the basic element of social organization, defining also modern architecture as a synthesis of all the arts creating a new space and aesthetic for the 'New Man'.

Through the drawing one can investigate the meanderings of architectural thinking of the past, so all graphic signs, recognised within this path of investigation, may be part of a corpus of rules, and codified data in the interpretation and reworking design process. This paper proposes a graphic re-reading of the 'House of Dr Nelken in Warsaw' that Helena Niemirowska designed in 1932. The building, on two levels, shows in its form a strict geometric layout and a three parted-subdivision plan in which she defines the functional internal layout both at the ground and first floor. Even on the façades, in line with the geometric rigor inherited from the study of the pure form, conceived as a generator of architectural space, she combines Suprematism and Modern Movement, cultural influences revealed by surfaces, colours and volumes of seemingly static treatment.

Keywords: representation, graphic analysis, drawing, Helena Niemirowska Syrkus, Modern Movement

### Introduction

The operation of re-drawing, together with the study of the biography of Helena Niemirowska and her cultural and architectural influences, provides a further reading key of this emblematic figure of the cultural movement in Poland, a Polish woman and avant-garde pioneer of the most modern social theories on architecture.

Her work ranged from the urban planning proposals of Warsaw to the dwellings designed down to the last detail of furniture, from working-class neighborhoods of Tegal Baru to the 'Simultaneous Theatre'.

Helena Niemirowska who conceived an architecture that combined art and music, was also known as Helena Syrkusowa. She was an active architect of the fervent years of the Modern Movement during the propagation of the new architecture in the Polish capital whose objective was the definition of a language capable of expressing, through new configurations, the great revolutionary steps accomplished in the social, economic and political life of that time. She shared the vanguard thesis according to which the modern architect, to become an artist, had to rise to the basic element of social organisation, defining also modern architecture as a synthesis of all the art forms aiming thus to the creation of a new space and a new aesthetic for the 'New Man'.<sup>1</sup> The revolutionary approach of Helena Niemirowska contrasted with the ostentatious cult of the past, which saw the traditional residence of the Polish gentry and Zakopane style<sup>2</sup> the matrix from which getting plastic-architectural shapes as expression of national independence.

1 Marta Leśniakowska, "Szymon and Helena Syrkus," Artists in the Design & Innovation category, <http://culture.pl/en/artist/szymon-and-helena-syrkus#notes> (accessed September 10, 2015).

2 The 'Zakopane Style' is a type of architecture inspired by regional tradition of the Polish highlands also known as Podhale. This type of architecture, which incorporates motifs and traditions of the buildings of the Carpathians, was originally conceived by Stanislaw Witkiewicz (1851–1915) critic and art theorist, who used local traditions on richly decorated vernacular architecture, and enriched them through elements of Art Nouveau. Cf. Thomas Da Costa Kaufmann, Catherine Dossin and Béatrice Joyeux-Prunel, *Circulations in the Global History of Art* (New York: Routledge, 2015).

In Warsaw there were two different generations of architects with contrasting ideals. On the one hand, was the need for the self-representation of an increasingly authoritarian state, and on the other, the idealism which was unsettled by the poverty in which the proletariat lived. In time, in parallel with the development of Warsaw avant-garde raised by the cultural feature that linked the German Bauhaus, the Dutch De Stijl group and the Russian Constructivism, the Polish capital became an extremely lively laboratory of ideas and artistic experimentation, despite the general underdevelopment of the country.

### Helena Niemirowska

Helena Niemirowska was born in 1900 in Warsaw. An architect and urban planner, she was considered one of the protagonists of Modernist architectural avant-garde and was an emblematic figure of Poland art and architecture. In 1918–25, Helena's intellectual horizons and interests, spurred by her contacts with Warsaw artists and writers, led her to combine studies of architecture, at the Technical Academy in Warsaw, with drawing lessons by Roman Kramsztyk<sup>3</sup> and some studies dealing with philosophy, at the University of Warsaw, in different languages.

In her training, steeped in philosophy and architecture, Helena Niemirowska studied the first Polish avant-garde urban and architectural principles that were defining the basis for a new cultural attitude in the Polish capital. From the cultural influence of Le Corbusier, she took the concept of balanced harmony between architecture and painting. Above all Helena reinterpreted the dictates of the Bauhaus in Poland through the knowledge of the Cubist and Suprematist principles of Malevich and El Lissitzkij, objective of transforming them into spatial and pure architectural elements of the new architecture in the Warsaw. Furthermore, in the capital of the reconstituted Poland, the dualism between the internationalist impulses and the need for affirmation of national found identity bound each other with a natural mechanism of generational transition, that is, the appearance on the scene of a new generation of young architects from 1923–24.<sup>4</sup>

3 Roman Kramsztyk was a Polish painter of Jewish origin. He was born in 1855, lived and worked in Paris since 1922. He was one of the pioneers of the New Classicist movement of the twenties and thirties. In 1922, he settled in Paris, coming back every year in Poland. In the same year he co-founded the Rhythm (RYTM) Association of Polish Artists, whose members propagated the classic style in the Polish art of the twenties. His paintings were exhibited at the 'Art and Technology International Exhibition' in Paris in 1937 and at the World Expo in New York in 1939. (Irena Kossowska "Roman Kramsztyk," Artists in the Photography & Visual Arts category, <http://cultures.pl/en/artist/roman-kramsztyk> (accessed August 6, 2015)).

4 Among the Polish architects of this period, the most famous were certainly Lalewicz Marian (1876–1944) and Adolf Szyszko-Bohusz (1880–1942). Cf. Lech Klosiewicz, "Il costruttivismo e l'architettura polacca del XX secolo," in Silvia Parlagreco (ed.), *Costruttivismo in Polonia* (Torino: Bollati Boringhieri, 2005).

Helena Niemirowska would become one of the most famous representatives of the Warsaw vanguard, more favorable to innovation supported by the European avant-garde than to the previous generation who, once back at home, after years of training spent in European capitals, had preferred to search for national roots. These cultural contrasts between the two generations of architects transformed Warsaw into a laboratory of ideas and extremely lively artistic experimentation.<sup>5</sup> In addition to this was the presence in Warsaw of some of the most avant-garde trends of the twenties, a period when the European architecture was characterised by a network of intense collaborations and of influences in the wake of the artistic ferment that had involved Russia after the Bolshevik Revolution. This all played a key role in Helena's training.

The issue of the inseparability of art from social problems that Helena Niemirowska faced is best expressed in architecture through one of her most emblematic projects, the *Symultaniczny Theatre*, an example of simultaneous and unbuilt theater, in which the architectural space becomes a place for discussion, involvement and full participation of the spectator to social issues.

In 1924 she co-founded, together with her husband Szymon Syrkus, the first Warsaw vanguard, Blok (the Block of Polish Constructivists Suprematists Artists). However, in 1926, the desire to place architecture at the center of research and creation, plus some internal disagreements, led the majority of the members of the Blok to join Symon and Helena Syrkus in creating a new artistic and cultural group, the Praesens.<sup>6</sup> The program of this Polish neo-avant-garde group highlighted the relationship between architecture, sculpture and painting, generating a new composition through which the urban scale of the residential buildings systems and for collective life found a different form of architectural expression.

Topics covered in the modernist quarterly, *Praesens*, on the social functions of the new architecture also derived from the international exhibition on the residence that Helena had visited in Stuttgart in 1927, during which she had gained the experience of the 'contemporary apartment' (*Wohnung der Neuzeit*) and of the residential Weissenhof neighborhood, built by the German Werkbund.

The summer residence in Rakowiec, Warsaw, was inspired by the same principles between 1930 and 1939, with the steel structure for the modularisation of spaces demonstrating the new architectural trend on standardisation, on the one hand, and on the rhythmic plasticity on the other one.<sup>7</sup> Helena

5 Alfredo Boscolo, *Le trasformazioni urbane di Varsavia nel Novecento: Una guida bibliografica* (Roma: Carocci 2005), 87–88.

6 The Praesens group: Katarzyna Kobro, Jozef Bohdan and Lachert Szanajca were among the first to join the Praesens, then joined also Barbara Brukalska, Stanislaw Brukalski, Andrzej Pronaszko, and Marian Jerzy Malicki, Cf. Alfredo Boscolo, *Le trasformazioni urbane di Varsavia nel Novecento: Una guida bibliografica* (Roma: Carocci 2005), 95.

7 Roberta Chionne, "Blok e Praesens: Dagli ideali del costruttivismo alla sperimentazione funzionale," in Silvia Parlagreco (eds.), *Costruttivismo in Polonia* (Torino: Bollati Boringhieri, 2005), 157–198.

conceived of architecture as a discipline that could defuse the malaise that pervaded the poorest layers of the population of the big cities, less and less willing to accept the terrible living conditions of the industrial suburbs.

She was particularly active in all the meetings of the CIAM, starting with the second Congress held in Frankfurt in 1929, organised in line with the issue on compact apartments.

In 1946, she and her husband moved to the United States, then to England, teaching at the New School of Social Research in New York, the New Institute of Design in Chicago, and Harvard University, then at Cambridge and Dartmouth College.

In the following years, she was increasingly involved in the activities of young modern Polish architects interested in the formulation of a new, modern image of Warsaw. To better serve her interests, she was vice-president of CIAM between 1948 and 1954, fighting for the establishment of functionalist principles in Stalinist Poland and obtaining a certain success.<sup>8</sup>

In 1949, she joined the Warsaw Institute of Architecture and Design and in 1955 became professor at the Warsaw University of Technology, obtaining in 1979 the title of Professor Emeritus. She was also an active representative of the group, Jewish Women of Poland, and after the Second World War she became the first president of the League of Jewish Women, helping to hide many Polish children escaping to Israel.

### Helena Niemirowska's Projects

Some of her best-known built projects showcase her interests that ranged from the scale of a building to the detail of its interiors, and also demonstrate how she established a symbiotic link between the architectural space and the furniture.

This is evident in the project of the *House in Warsaw* in 1937, in which the key element is the curved line that derogates from the regularity of the building, conceived according to the cubic structure. In the *Two-family House in Sosnowcie*, of the same year, where the sinuous line marks the geometry of one facade, she worked proportionality in connection with the square and the rectangle. In the *Tegal Baru District* in 1969, the last extant and unbuilt work of Helena, she deals with the dwelling.

Actually, since the *Two-family House in Sosnowcie* more than three decades had passed but despite this we can find persistent themes such as regularity, ribbon windows, harmonic ratios related to

<sup>8</sup> Lodovico Belgioioso, "Il C.I.A.M. di Bergamo e Le Corbusier," in Giovanni Denti, Andrea Savio and Gianni Calzà (eds.), *Le Corbusier in Italia* (Rimini: Maggioli Editore, 2007), 61.

the square and the pure geometric forms. However, there is a remarkable change.

Indeed, the reference in the *Tegal Baru District* is mostly modernist. The geometry prevails on the definition of the form and the reference to the architectural volume of the Modern Movement has undergone the interpretation of the Polish vanguard by way of the modularisation and, therefore, the democratisation of the compositional thought.

Aiming to adequately exploit the new available technologies, Helena Niemirowska had been interested in the Taylorization since 1925. Nevertheless, one of the projects that best describes the socio-architectural aspect of the Polish architect is the *Symultaniczny Theatre*, in 1927, also called Theatre of the Future: a space that would allow you to address, simultaneously the different issues of the theater scene, through advanced technologies and kinetic effects.

The main objectives pursued by Helena were flexibility, freedom of movement and the union of the theatrical scene with the audience. The theater was conceived as a whole that included the spectators, thus diverging from the traditional separation of the stage from the audience. The project was conceived together with Andrzej Pronaszko<sup>9</sup> and designed according to the theoretical principles of the Total Theatre by Walter Gropius of 1927.<sup>10</sup> The idea was to create a space with separate areas of activities where various actions can be performed. The theater was deprived of the stage and the performances for the spectators were defined through a free configuration consisting of a circular base which determined a rotational movement. The stage of this architectural-scenic machine was able to rotate and take different configurations depending on the arrangement to be realised.

<sup>9</sup> Andrzej Pronaszko (1888–1961) was a Polish painter and stage designer, one of the leading exponents of the Young Poland movement and the Polish avant-garde of the twenties and thirties. During the occupation of Poland, he was a member of the Polish resistance and director of the Department of microphotography at the Bureau of Information and Propaganda of the Home Army. After war Pronaszko became professor at the Academy of Theatre of Warsaw (Akademia Teatralna), Cf. David Crowley, *National Style and Nation-state: Design in Poland from the Vernacular Revival to the International Style* (Manchester and New York: Manchester University Press, 1992), 107–109.

<sup>10</sup> The idea of the Total Theatre emerged in 1927 from the collaboration between Walter Gropius and Erwin Piscator. The aim was to develop a project linked to the concept of a theater that would overcome the traditional structure of the stage sets and produced a building that combined all parts of the theater: scenic depth, proscenium and the central area of the scene. The idea of Gropius for the realization of this structure was that of a movable and rotating plate, which could be moved during a theatrical performance to create the different scenography's situations. In addition to the mobility of these rotary layers, together with the auditorium, it was very important for Gropius that the mechanism for the production and operation of the theatrical spaces would extend to the installations of light frame, Cf. Silvana Sinisi and Isabella Innamorati, *Storia del teatro: Lo spazio scenico dai greci alle avanguardie storiche* (Milano: Mondadori Bruno, 2003), 229.

### Graphic analysis of the 'House of Dr Nelken in Warsaw' (1932–33)

This graphical interpretation of existing archive drawings is of the house of Dr John Nelken in Kostancin (Warsaw), designed by Helena Niemirowska in 1932–33 (to date existing in Uzdrowiskowa 5, Konstancin-Jeziorna) with a particular interest on the dwelling project that also included the furniture and other functional details (Fig. 1).

The archive drawings on which are based the redrawing and graphic interpretation include two photos of the building and two plans, of the ground and first floor.

The one-family house on two levels rests on a colour-differentiated base with respect to the wall surface of the architectural body treated with a white cement coating. We can identify the same differentiation element between the base and the entire architectural body, emphasising the function of each architectural parts in relation to the entire volume, in other concurrent projects. These include the *House of Dr. Bernstein in Konstancin* (1931), in dwellings in Saska Kepa (1937) or in the working-class neighborhood in Rakowiec realised between 1936 and 1938 for the WSM (*Warszawska Spoldzielnia Mieszkaniowa* which translates as Cooperative for construction of dwellings of Warsaw) using a wooden frame and masonry coating.

The outer skin of the house is defined by a system of openings which alternates solids and voids in a gradual manner. Indeed, along the surface of the main entrance, which is transparente for half of the entire side, there is a fully glazed elevation rising from subtractions of volumes (Fig. 2). A terrace on the second level develops longitudinally on one side, stopping abruptly at a rear

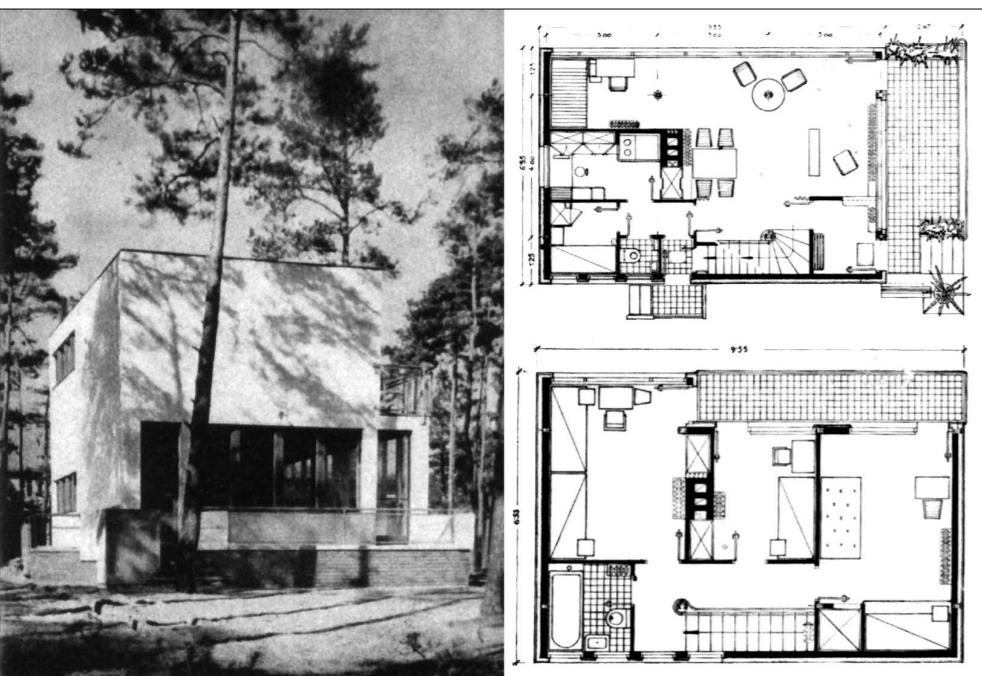

Fig. 1. House of Dr. John Nelken in Kostancin (Warsaw), by Helena Niemirowska in 1932–33.

elevation, where the unadorned surface has only one window, aligned with the others of the entirely glazed main façade (Fig. 3). The lateral elevation has a repetition of four square windows for half of the wall, highlighting even more this distribution of transparency in the vertical surfaces delimiting the architectural body (Figs. 4 and 5).

The first floor is raised by 75 cm, indeed, the base on which the whole building rises defines a difference in height exceeded at the main entrance with five steps leading to a terrace developed for the entire façade with the sequence of windows and by another five steps at the side entrance (Fig. 6).

The main entrance opens into an antechamber, a holing into the sidewall, which allows the visual communication of the interiors. Helena Niemirowska delimits each space through a door, as if she wanted to force the functional definition of environments that, through the movement of 'transition', takes on more importance.

The action of entry and exit into a space emulates the rhythm of movement and for that reason, the three-door system at the side entrance marks the moments of the displacements of the visual-compositional sequence that going towards the inside, leads the occupant to an unveiling of the architecture (Fig. 7).

The ground floor has a large open space with two fully glazed sides, the dining room, the living room and another private space used as the studio. On the plan for this floor, one can detect a scanning of the spaces which, opposed to the opening into the living area, articulates smaller volumetric intervals in which Niemirowska obtains, in an anticlockwise reading a kitchen, a lumber-room and a bathroom (Fig. 4).

With a deeper look, one notices the 'slowness' as one goes toward the living space, the reflection and studio space. These acquire more two-dimensional importance compared to the rhythmic 'speed' of service rooms. The entire plan can be inscribed within a double diatessaron (ratio 9:16), marked on the long side by five semicircles that identify the stride of the ground-floor terrace (Fig. 8). On the smaller side, a major sixth (ratio 3:5) identifies the spaces described above that are opposed to the opening of the living, inscribed in a tuning fork (1: 2). The entire living area, excluding the terrace, all inscribed in a diatessaron (ratio 1:√2).

The plan of the first floor has only two longer glazed sides, in particular there is a correspondence with the golden ratio (1:φ) which on the shorter sides identifies sequences of windows on two opposites facades and a diatessaron that, on the long side identifies the glass surface overlooking the terrace. Finally, the division into three parts of the spaces placed in the center of the first floor is detected by a diapason diapente (ratio 1:3), while other harmonic ratios are identifiable in other areas of the plan, as in the case of a diapason diapente, a golden section and a diapente (ratio 2:3) in correspondence of the service rooms (Fig. 9).

Even the elevations accord to other harmonic ratios: a diapente at the longer side where the terrace is placed; and a second minor (ratio 15:16) corresponds to the side with only one window, which results in 1/4 of the entire height of the building and placed exactly in half façade.

The graphic analysis, led by defining harmonic ratios, enriches the knowledge of architectural body and is synthesised through a critical reading combined with the hermeneutic practice of redrawing. This analytical approach sheds light on the sequence, development and volumetric composition of spaces, both in plan and on three dimensions, facilitating the understanding of the material and spiritual elements that converge into the composition of space (Fig. 10 a, 10 b).

The graphic analysis was also conducted through the development of more 'moments' of the drawing. The graphic construction of elevations and sections made possible to provide new spatial and metric data of Helena Niemirowska's project. Indeed, the accuracy of these orthogonal projections communicates with a purely theoretical field of the drawing, which is that of the spatial imagination and graphic communication, in order to provide information on both the technical level-composition and on that evocative and architectural one.

While the orthogonal projections form the grammar of drawing through the development of plan, elevation and section, the graphic survey uses the vision into the architectonic space examined by exploded and isometric cutaway views. The former delimit Helena's project according to layers and then, through a correspondence in height of the two levels of the building, allows an 'interlocking' reading of the architectural parts composing the project. The graphic surveys enhances the accuracy of the section through the spatial force of isometric view that slices architecture into parts of a whole impressed in the memory of the knowledge previously acquired.

More elaborate participation in the graphic survey is realised through 3D modeling software able to build a new digital space of Helena Niemirowska's project. The moment of rendering, subsequent to the phases of redrawing, constitutes a key reading rising from the new digital techniques that moves within a virtual space in which perspectives at a height of 1.70 m around the building, bring into relationships lights and shadows of the architecture: the moment in which the material becomes plastic and unlimited in dialogue with light.

For the same reason the sections of isometric rendered views and perspectives dissect an architecture that interacts with the virtual infinite space of tridimensional modeling, marking a culmination of graphic interpretation and a new starting point in the investigation of the architectural project.

Helena Niemirowska's vision of architecture maintained a fundamental social meaning since it aimed to influence the organisation of social life. The industrialisation of the building was linked to the standardisation of single elements, as well as design compositions, no longer centered on single dwelling, but aimed at enhancing the repeatability of the modules.

Furthermore, her research was aimed to conceive a type of dwelling easily reproducible in an industrial manner and modifiable according to need or taste, by resorting to a sort of internal mobility obtained through the adoption of a movable partitions system. Her pursuits were aimed at the definition of a standardised dwelling-type that had the ability to grow, and at the same time, to multiply in various combinations. Such a conceptual approach was not actually very far from the many other voices rising from many areas in Europe in the twenties, especially in the eastern and economically underdeveloped part of the continent.

Another piece of the history of Polish modern architecture, which, through the inquiring eyes of contemporary subject, is brought to light, in a suspended condition of the project during the time of Helena Niemirowska and relocated in a rotating circle that represents the time. A plan, an isometric view, a perspective section and a render, space of imagination that in uncertain condition of interpretation affect, with force, on the rock of the drawing.

This graphic investigation of the architectural thinking of Helena Niemirowska shows only one of the infinite possibilities of architecture interpretation.

Figures:

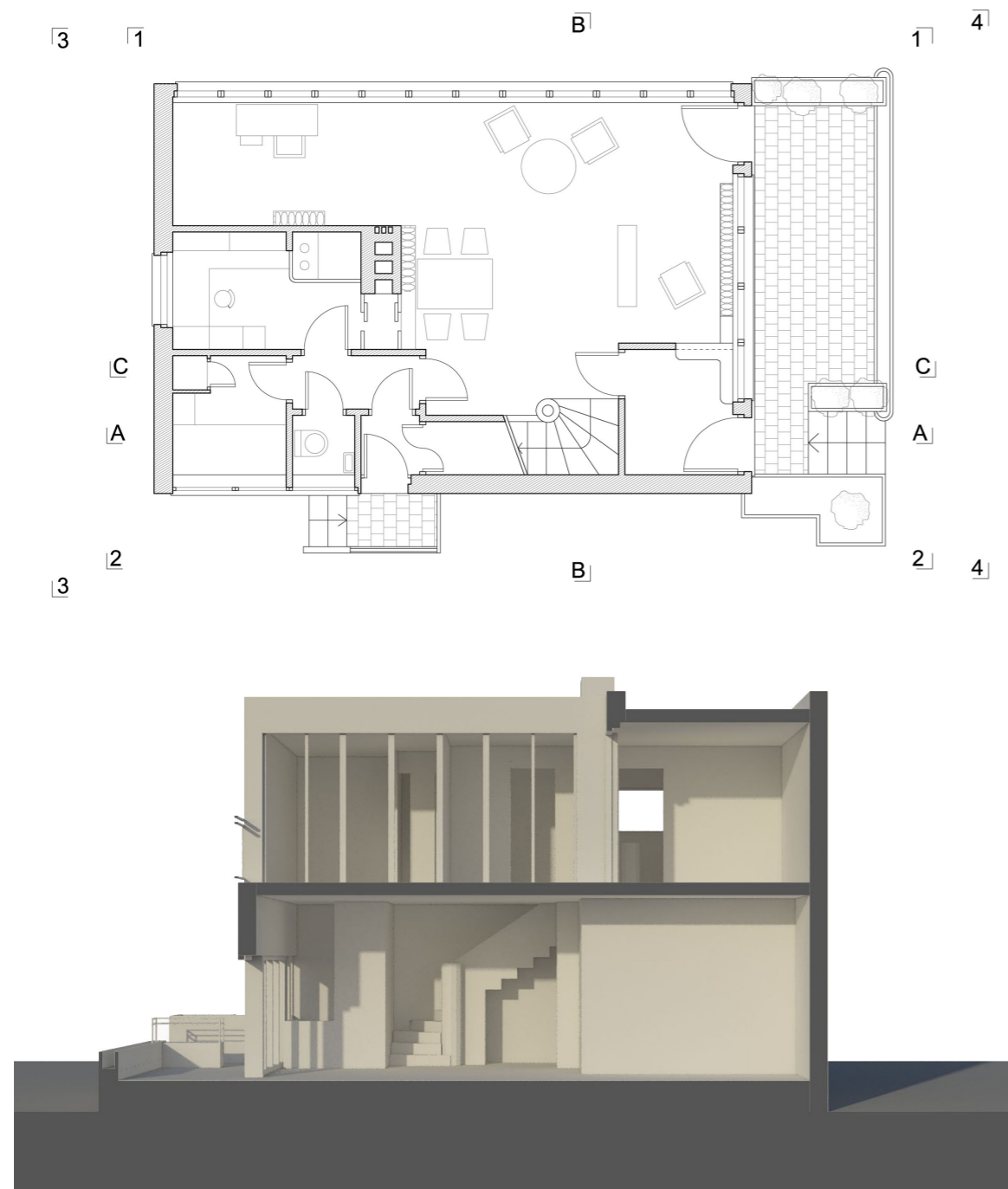

Fig. 2. Plan of the ground floor and perspective section.

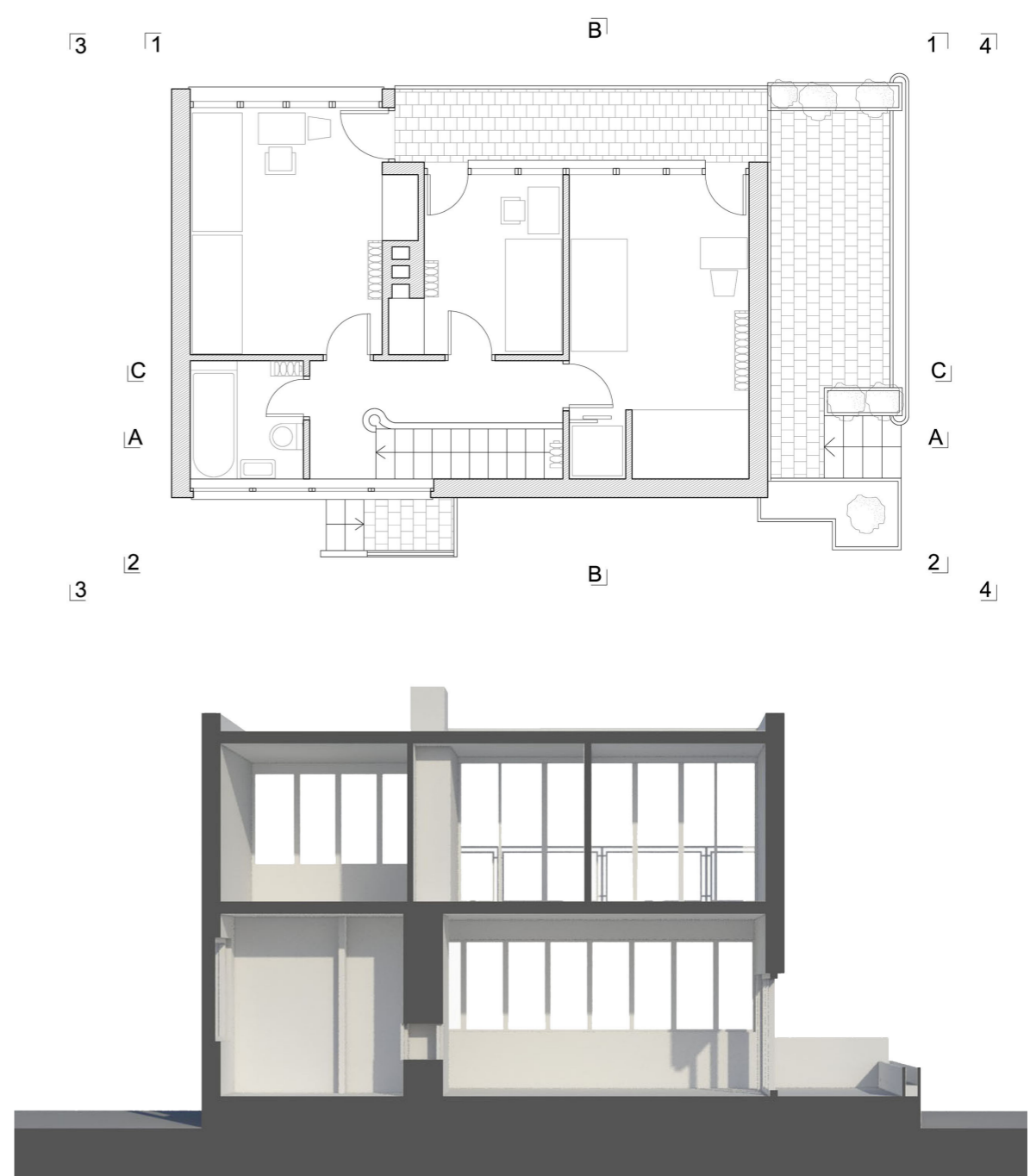

Fig. 3. Plan of the first floor and perspective section.

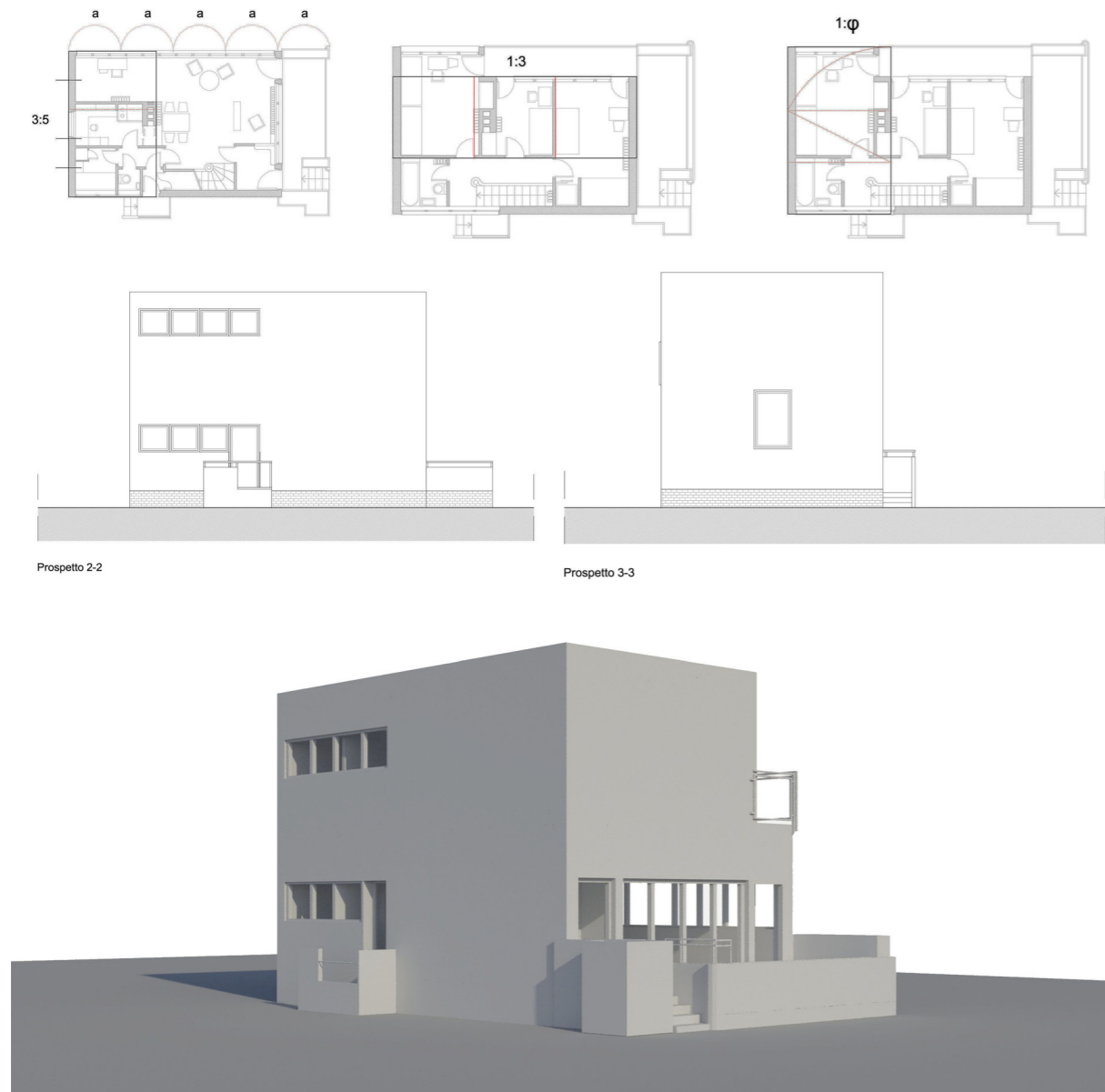

Fig. 4. Harmonic ratios of the ground floor and first floor, two elevations and perspective view.

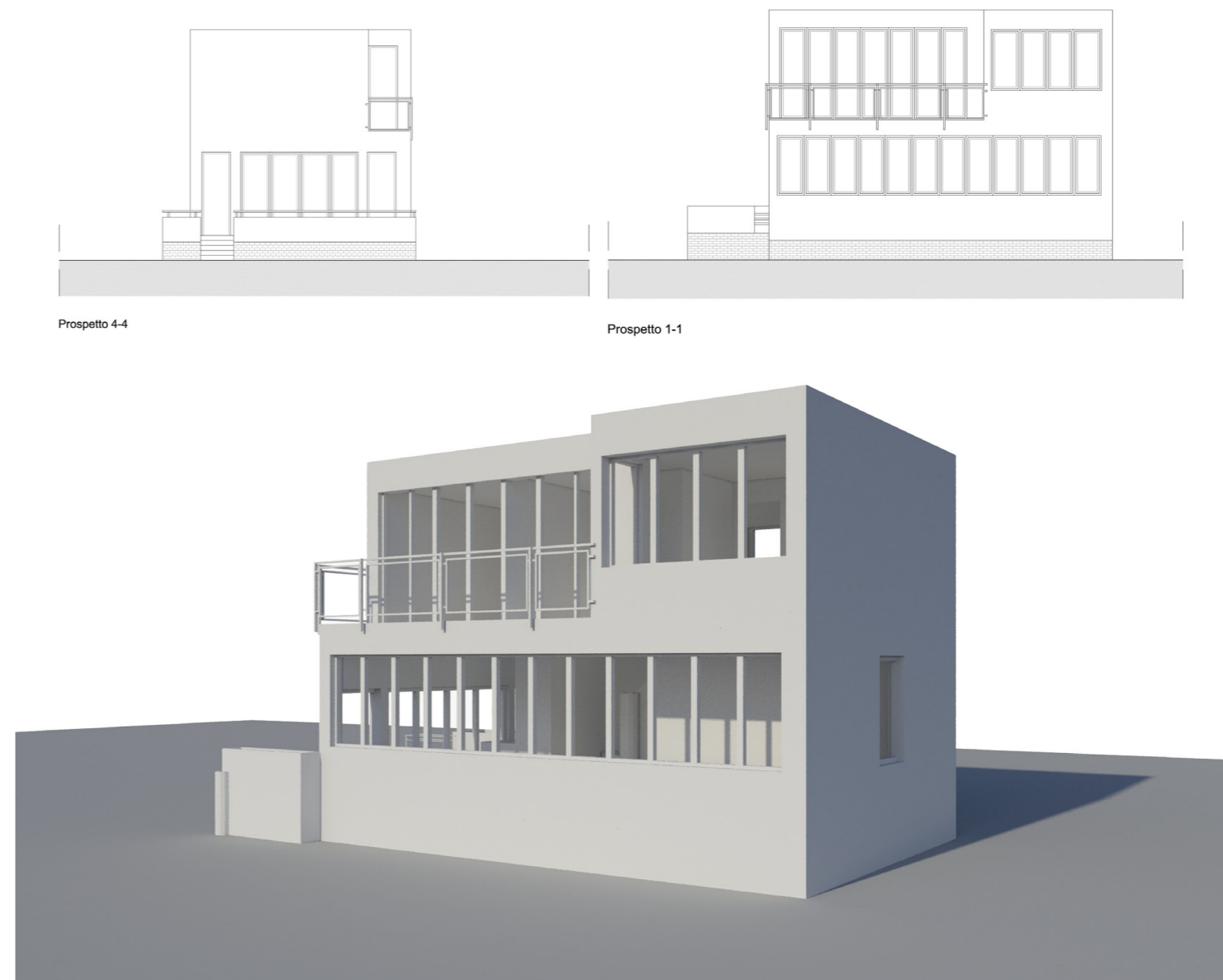

Fig. 5. Two elevations and perspective view.

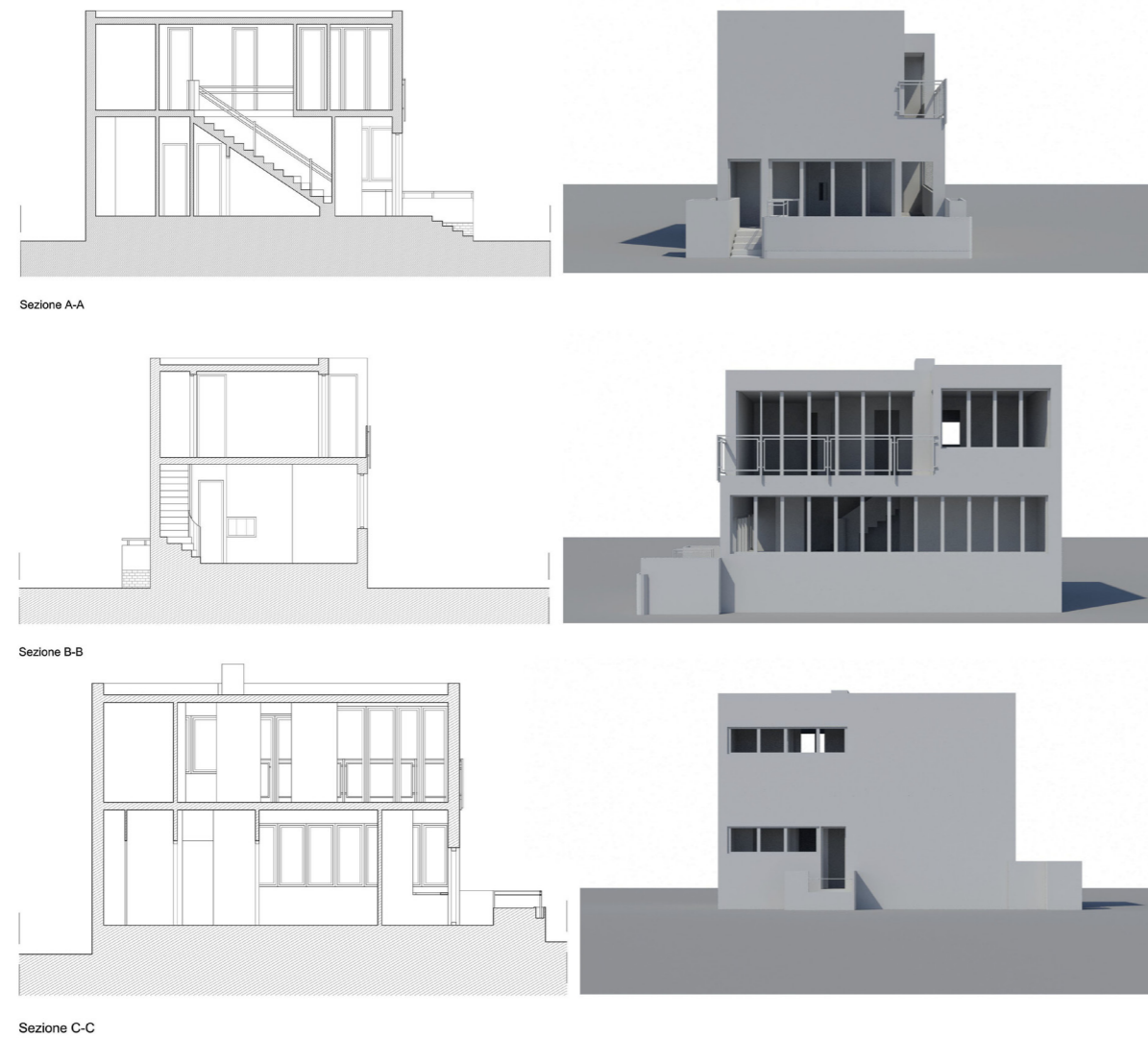

Fig. 6. Sections and rendering.

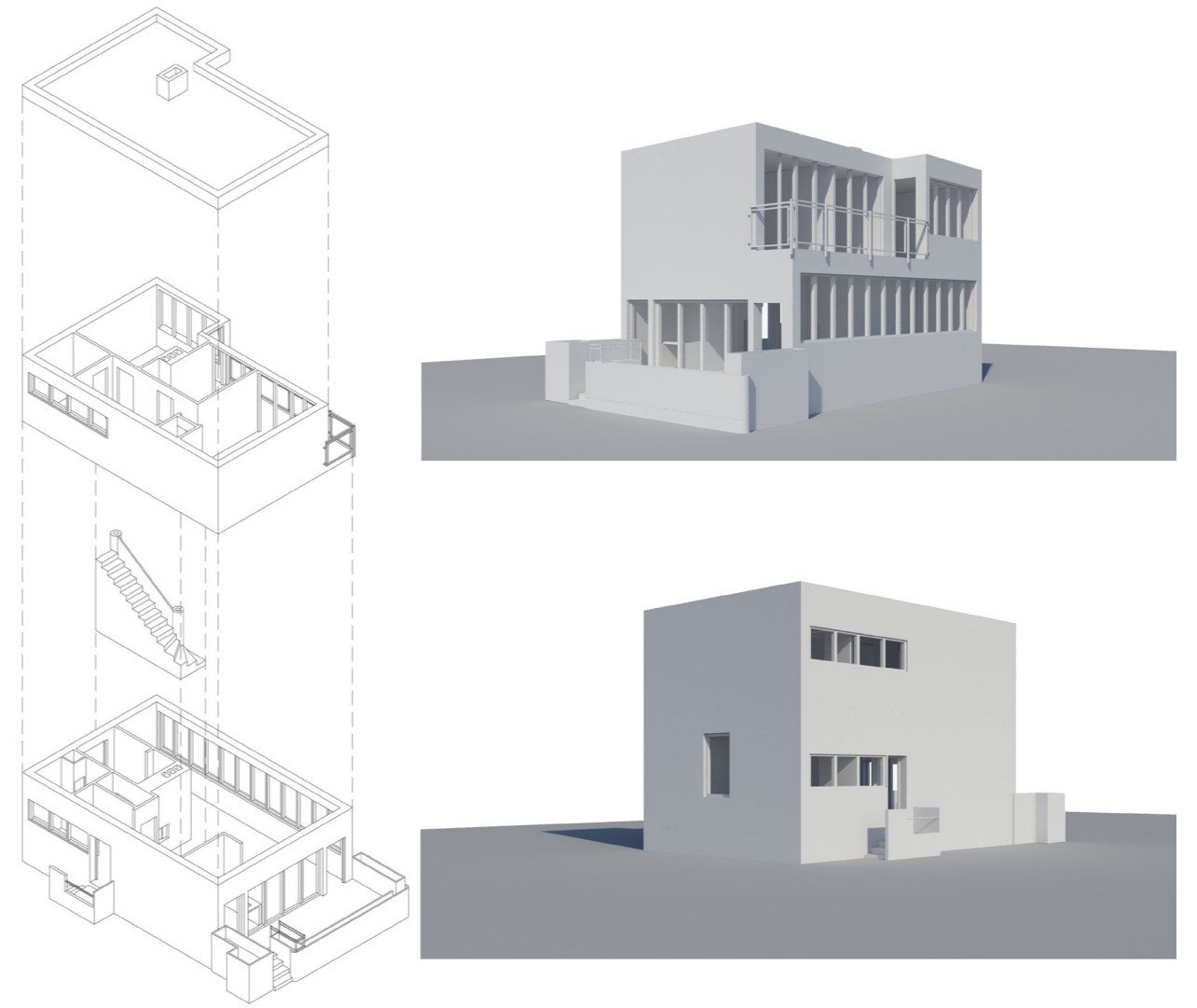

Fig. 7. Exploded and perspective views.

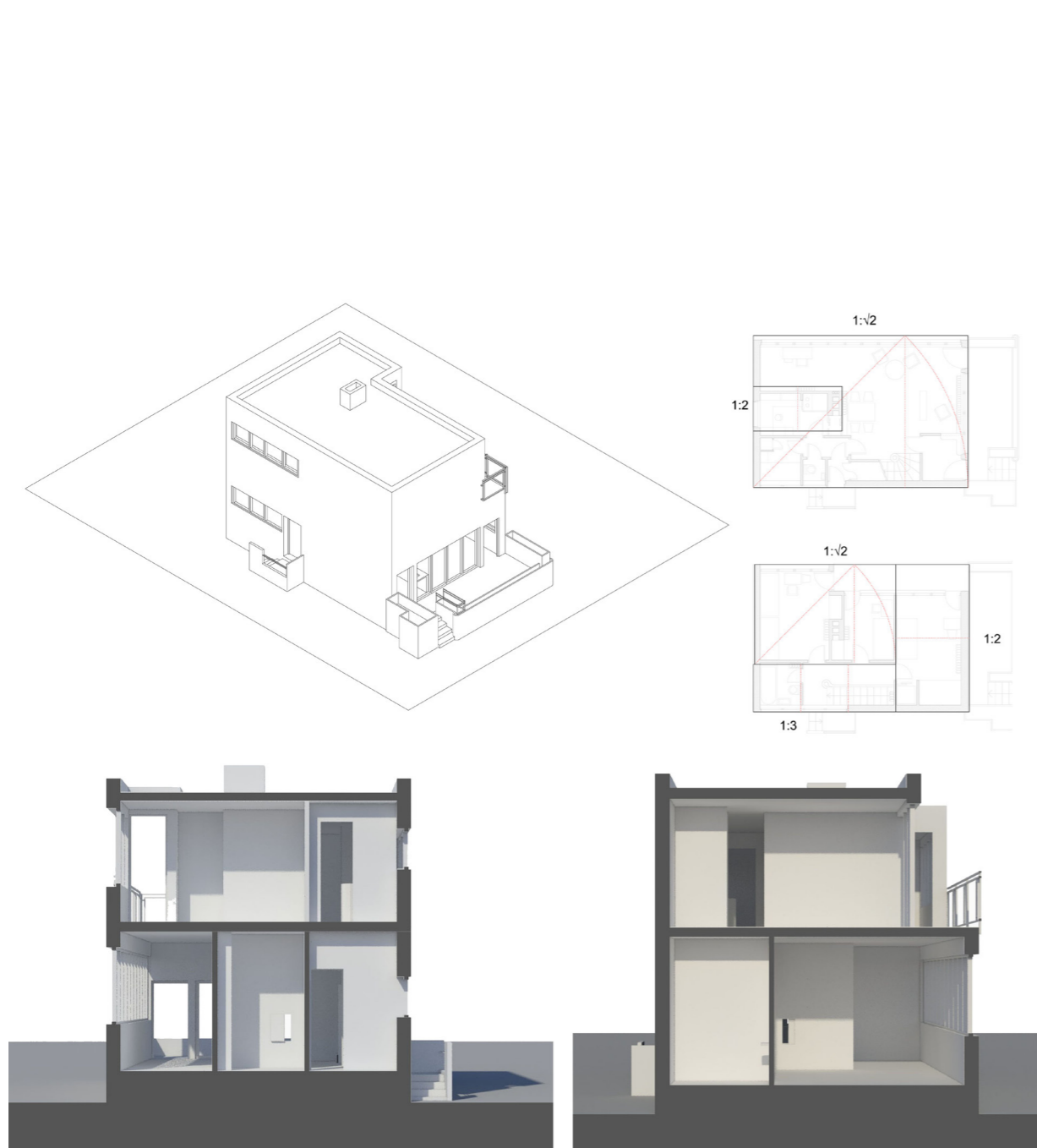

Fig. 8. Isometric view, harmonic ratios of the ground floor and first floor, and two perspective sections.

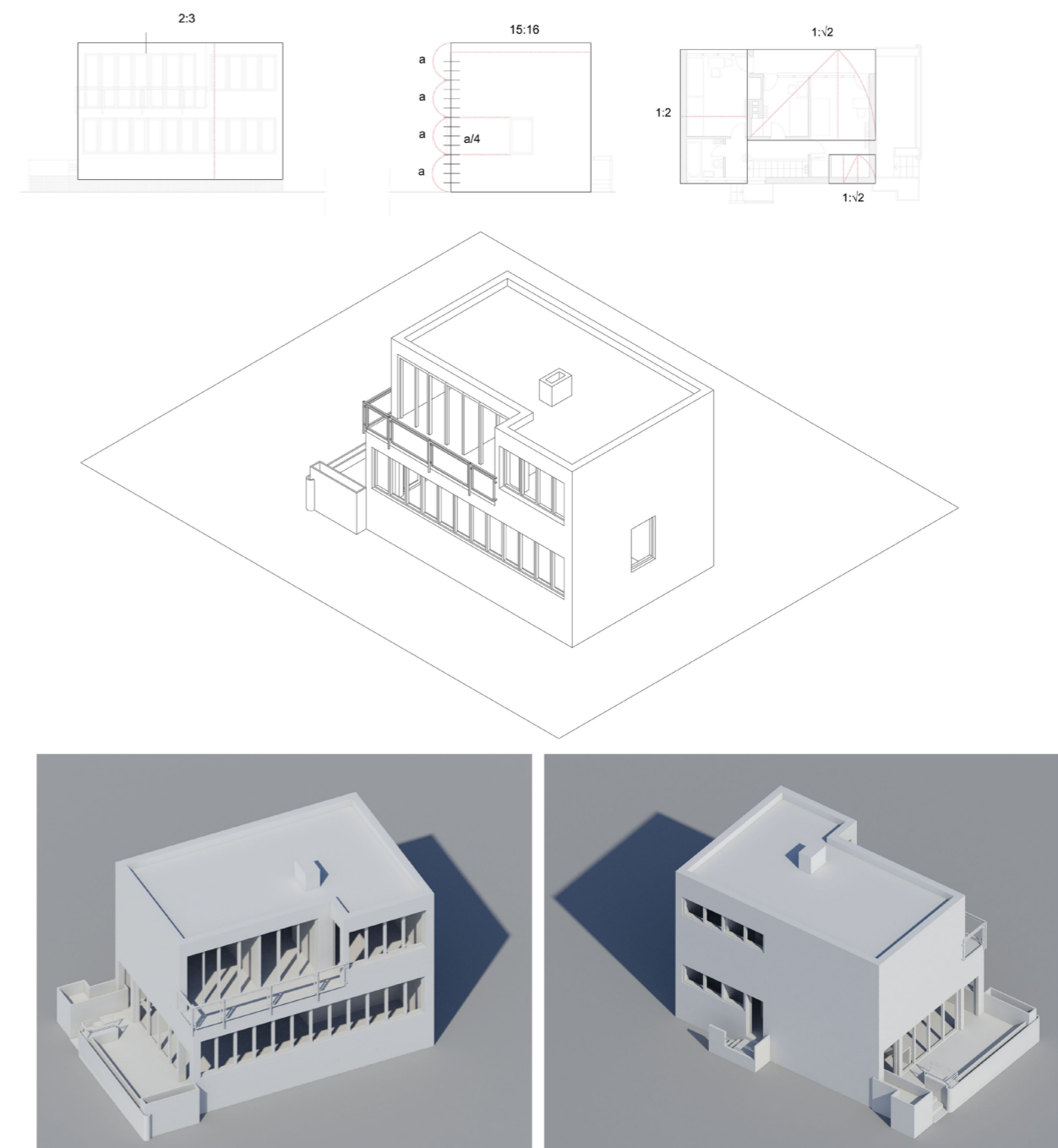

Fig. 9. Harmonic ratios of two elevations and first floor, isometric view, and two renderings.

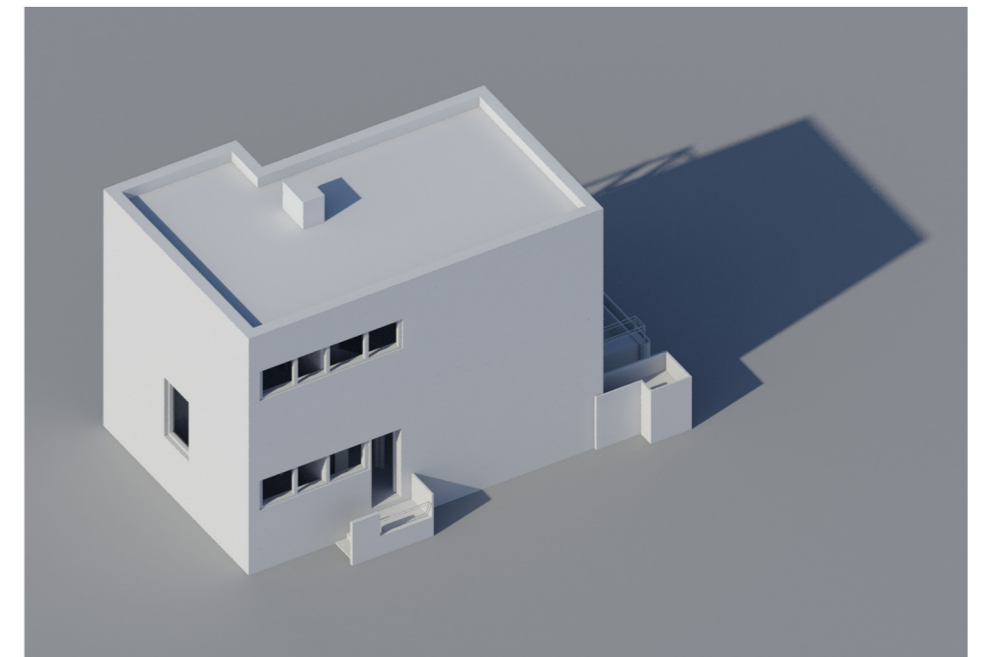
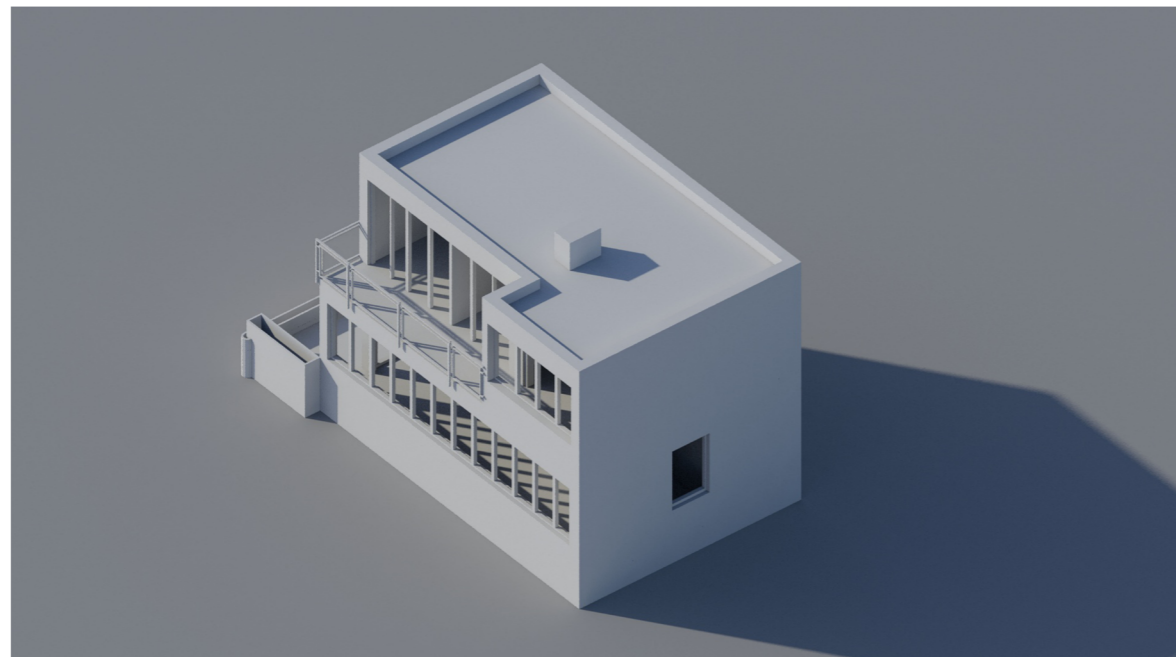
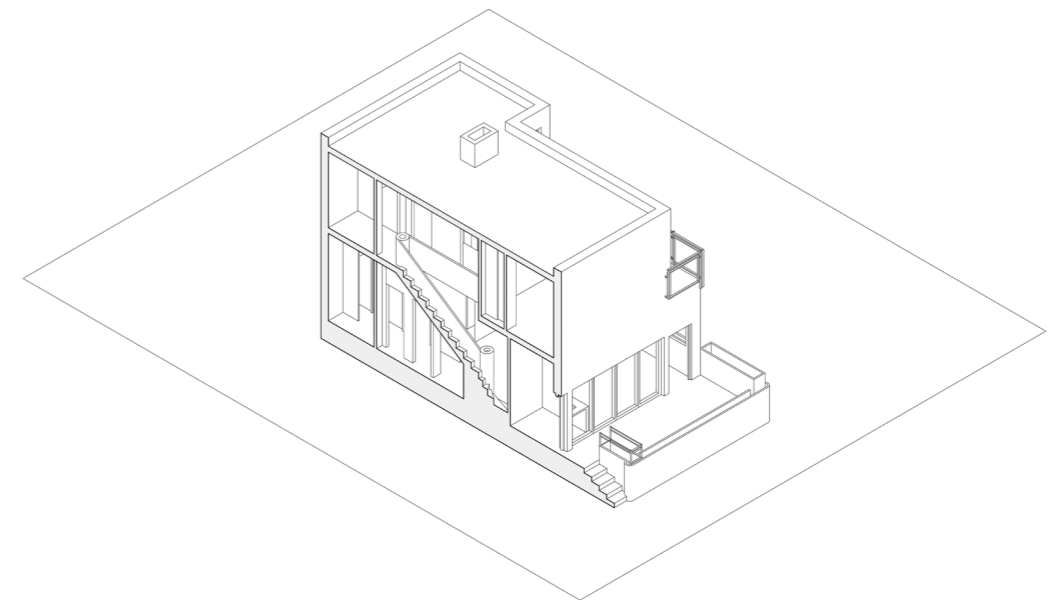
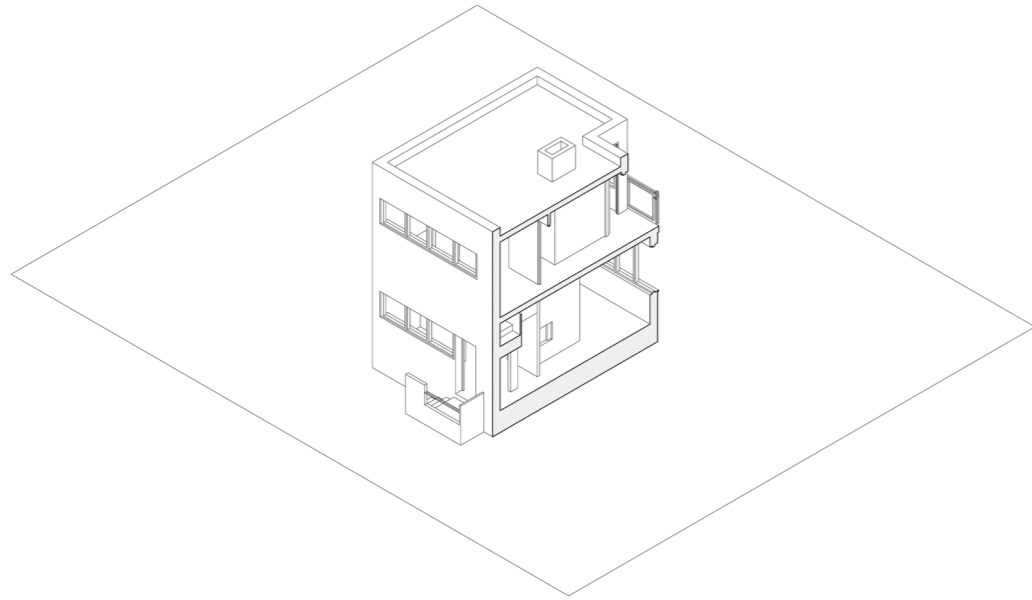

Fig. 10 a. Isometric section and isometric view.

Fig. 10 b. Isometric section and isometric view.

### Starlight Vattano

Università degli Studi di Palermo, Dipartimento di Architettura D'ARCH  
University of Palermo – Department of Architecture



Starlight Vattano (1987), PhD, Architect. She graduated in Architecture in 2011, with a thesis entitled "Eileen Gray, an elusive subject. Graphic interpretations of the Centre de Vacances". PhD in Architecture, University of Palermo, Department of Architecture. She published and presented her articles at several international conferences about representation of unbuilt architecture dealing with the study of women pioneers' projects of the Modern Movement. She is also interested in visual studies and the relationship between graphical movements and geometric shapes. She undertook a period as visiting researcher at the Escuela de Arquitectura of Malaga and at the Faculty for the Built Environment of the University of Malta.

E-mail: [starlight.vattano@unipa.it](mailto:starlight.vattano@unipa.it)



## Charlotte Perriand: Graphic Analysis of the 'Maison du week-end'

The 20th century was characterised by a radical modernisation not only in the built environment but also in society, particularly in the condition of women. This article proposes a graphic reinterpretation of one of the most significant of Charlotte Perriand's projects which was a response to the social problems arising in the early 1930s in France during the establishment of the Popular Front's new socialist government. It regards the unrealised project known as *Maison du week-end*, designed in 1934 for the competition organized by the journal *L'Architecture d'Aujourd'hui*.

In particular, in her project of the private holiday house, the small temporary home turns into a manifesto of the new architectural culture and into an experimental field through which Perriand investigates a theme common to her whole work: the definition of interior spaces as instigators of a new way of living.

Starting from this definition, Perriand offers a new point of view on the minimum living space for leisure and a radical architectural interpretation of French industrial modernity. The graphic reading of this never realised project gives us a valuable demonstration of one of the most emblematic figures in the history of modern architecture through which the drawing interprets forms and spatial reasons.

Keywords: representation, graphic analysis, Charlotte Perriand, Modern Movement

The period that is the background of the architecture project analysed here was characterised by the important innovative laws of the 1920's and 1930's. Indeed, the French government had given more rights to the working-class including, for the first time, paid holidays. Several architectural competitions were organised for the realisation of areas for leisure or, at building scale, of minimal week-end housings through which it was possible to experiment with the latest innovative technologies. Among the most important figures who worked with rigorous and sophisticated survey methodologies was Charlotte Perriand (1903–1999), who presented her vision of the minimalist architecture for leisure and holidays.<sup>1</sup>

With this contribution she identified a part of her architectural philosophy of economic and functional composition of volumes.

An independent and anti-conformist figure, Charlotte Perriand, established an important role in the architecture of the 20th century becoming one of the Modern Movement pioneers and contributing to the definition of a new femininity thanks to her determination and her view of modern woman. Even if in that period Art Déco spread in France, Perriand understood that the emblems of that art belonged to the past and that spaces, pure geometry, light, new materials, machines and factories would take the place of the decorative art.

Charlotte Perriand loved the present but she looked to the future and she was fascinated by cars and by their curved shapes and their bodywork. She realised that the age of machines represented an humanist ideal, which would make human life easier and more comfortable. Reading *Vers une Architecture* and *L'art décoratif d'aujourd'hui* by Le Corbusier gave her insight into the views of a new man close to her modern vision of life, a vision that was evolving from a domestic ideal anchored in the decorative art, to a functional and rational one. Today she is still known mostly for her interior

<sup>1</sup> For Charlotte Perriand and this topic, see Charlotte Perriand, *Io, Charlotte tra Le Corbusier, Léger e Jeanneret* (Roma-Bari: Edizioni Laterza, 2006); Charlotte Perriand, *Charlotte Perriand: Un art de vivre* (Paris: Flammarion, 1985); Jacques Barsac, *Charlotte Perriand: Complete works, vol 1:1903–40* (Zürich: Scheidegger & Spiess, 2014); Jacques Barsac, *Charlotte Perriand: Un art d'habiter 1903–1959* (Paris: Editions Norma, 2005); Elisabeth Védrenne, *Charlotte Perriand* (Paris: Editions Assouline, 2005); Arthur Ruegg, *Charlotte Perriand: Livre de bord 1928–1933* (Basel-Berlin-Boston. English Edition Birkhäuser, 2004).

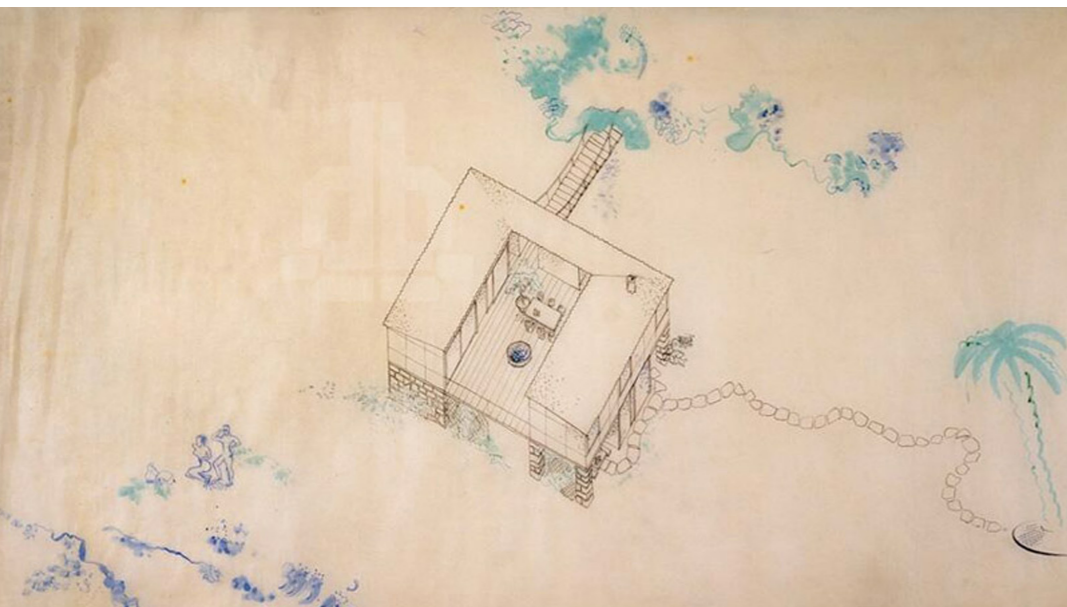

Fig. 1. Sketches of the 'Maison au bord de l'eau' by Charlotte Perriand. Published in Jacques Barsac, *Charlotte Perriand: Complete works, vol 1:1903-40* (Zürich: Scheidegger & Spiess, 2014).

designer activities rather than for architecture, even if many documents testify to her experience as building designer.

Charlotte Perriand's trajectory was neither linear nor premeditated. She proceeded by leaps that led her from one setting to the next, with return loops to themes that inspired her.

She started her work in the rue de Sèvres studio, to the left of Le Corbusier and where Pierre Jeanneret was partner in charge of furniture. Le Corbusier selected Charlotte to complete his program on the humanisation of interior design and to develop his concept of 'furniture to live'. After the first years of collaboration, Perriand specialised independently in prefabricated architecture for recreational purposes and built a series of vacation houses that could be used by a great number of people.

In the early 1930s, before the Popular Front rose to power in France in 1936, Perriand found the organisation of leisure one of the most 'urgent problems' to resolve. Le Corbusier wrote about it:

The recreations of the age of the machine, from the first day of the reorganisation of production, emerge as a social danger: imminent threat. Soon, inevitably, the organisation of production will open up vacant hours each day for everyone... This is one of the most troubling problems of contemporary sociology. We therefore feel the need to quickly transform the unformed acceptance of leisure into a disciplined function. We cannot abandon seven to eight hours a day to millions of men and women and young people in the streets.<sup>2</sup>

Similar to other architects, Perriand participated in various competitions, including one organised by the journal *L'Architecture d'Aujourd'hui* to design a week-end house. The competition was to plan

an inexpensive week-end house, designed to be built on a river bank, and to lodge a five-person family and two guests. Perriand worked out two solutions: the first was the *Maison du week-end*, for which she received the second prize, and the second known as *Maison au bord de l'eau* (Fig. 1), remained on paper. However, under the direction of Perriand's daughter, Pernelle, and Louis Vuitton's support, prototype was faithfully built by Cassina according to the vintage plans.

The project itself was most likely inspired by the modest fishermen's houses built on pilotis around Arcachon Bay, which she had seen while she was on vacation with Le Corbusier and Jeanneret in 1934.<sup>3</sup>

Main elements could be built industrially: metal frame, floor panels, interior and exterior walls, ceilings. These elements could be mounted in various arrangements depending on the site. Inspired by the inventiveness of campers, Charlotte Perriand planned a flexible house, produced in series, designed for modules and delivered in mounting box, whose foundations would be realised with local stones.

Through graphical analysis, like a critical-communicative tool, it is possible to investigate the *Maison du week-end*, one of the most important *habitation minimum* projects designed by Charlotte Perriand providing recreation at an economic price. This graphic practice is very useful to interpret the design process, particularly because it is an unrealised project about which it is impossible to have any direct information on formal and spatial values. The vintage drawings include a plan, three sections, three facades and an axonometric scheme.

The graphic reworks realised of the drawings listed above, concern a plan, four sections, four facades, an axonometric scheme, functional schemes and a digital model. The latter represents the synthesis of all other representations and the various hermeneutics declinations resulting from these<sup>4</sup>.

The design presented two symmetrical volumes facing one another and opening into a wood terrace raised on pilotis above the level of the river. The whole structure was designed and supported by stone pillars. In this way, one could be at a distance from the river and have a healthy and livable construction without interferences. As she said in the competition text, she intended to design a wooden tent, a free space without further internal developments. Charlotte Perriand gave up defining interior spaces in order to allow the tenants who lived there the ability to participate in the formal interior composition.

Through studying the plan it has been possible to get much information about the interior organisation. According to records drawn by Perriand, the A volume was intended for the family, instead the B volume for the guests and the kitchen (Fig. 2).

<sup>3</sup> Cf. Barsac, *Charlotte Perriand*, 302.

<sup>4</sup> Cf. Riccardo Migliari (ed.), *Disegno come modello: Riflessioni sul disegno nell'era informatica* (Roma: Kappa, 2004), 6.

<sup>2</sup> Le Corbusier, *La Ville Radieuse* (Boulogne: L'Architecture d'Aujourd'hui, 1933), 64.

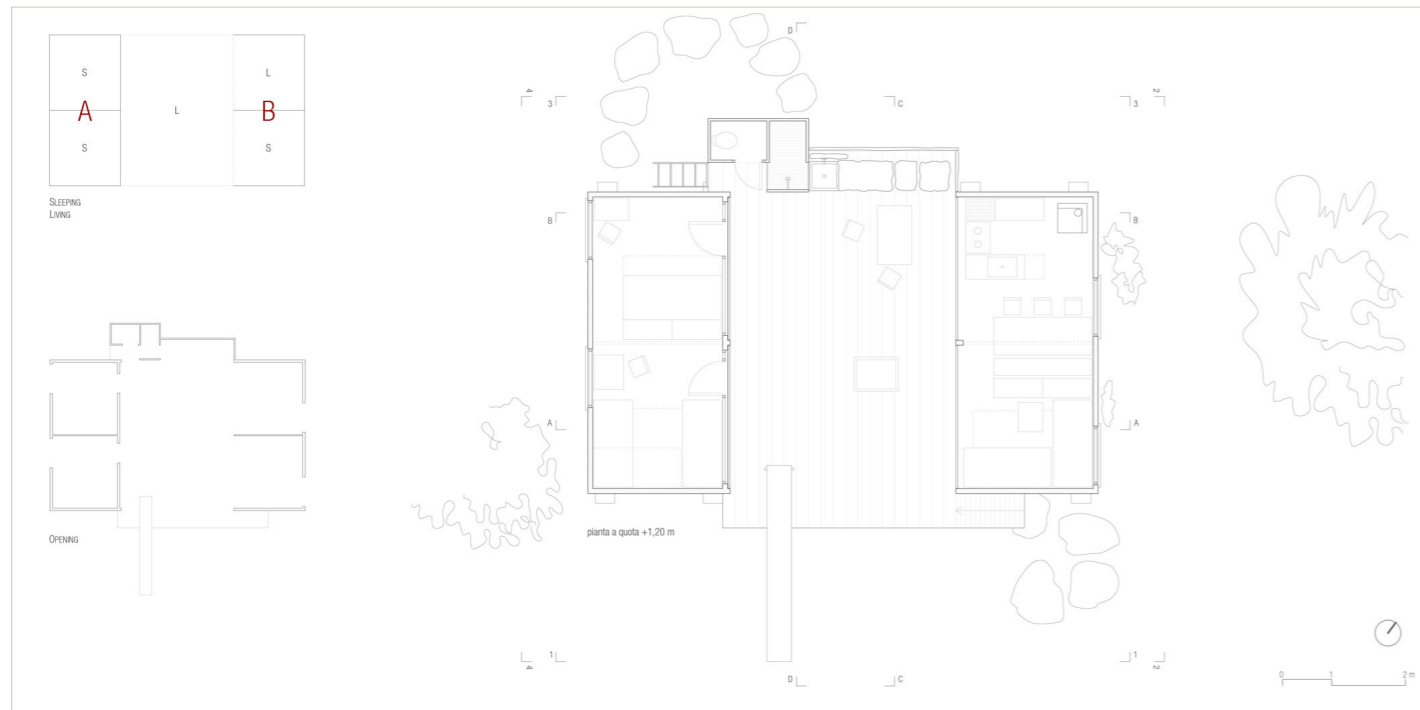

Fig. 2. Graphic interpretations of the 'Maison du week-end', Plan and schemes. Graphic produced by the author.

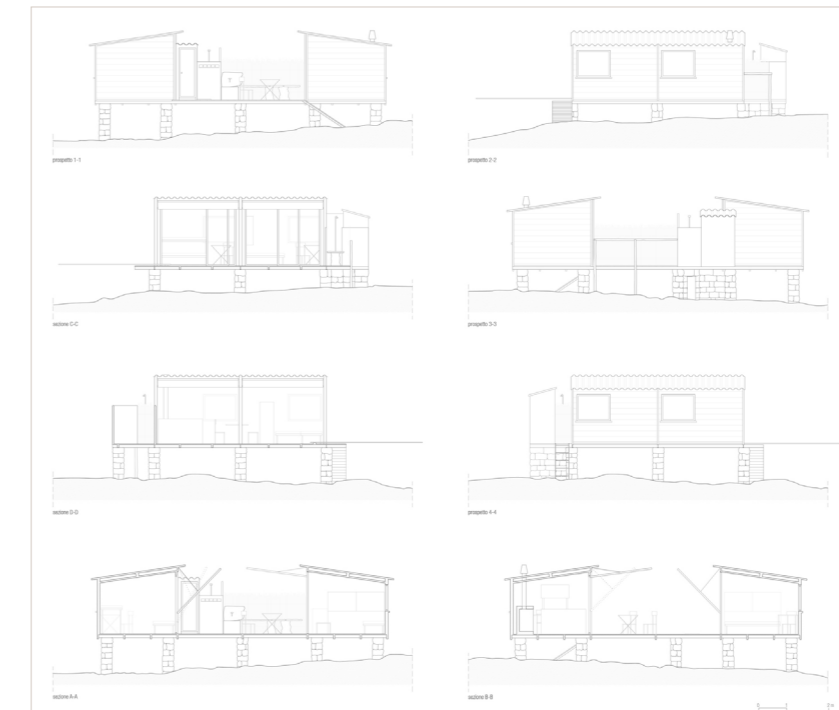

Fig. 4. Graphic interpretations of the 'Maison du week-end', Sections and facades. Graphic produced by the author.

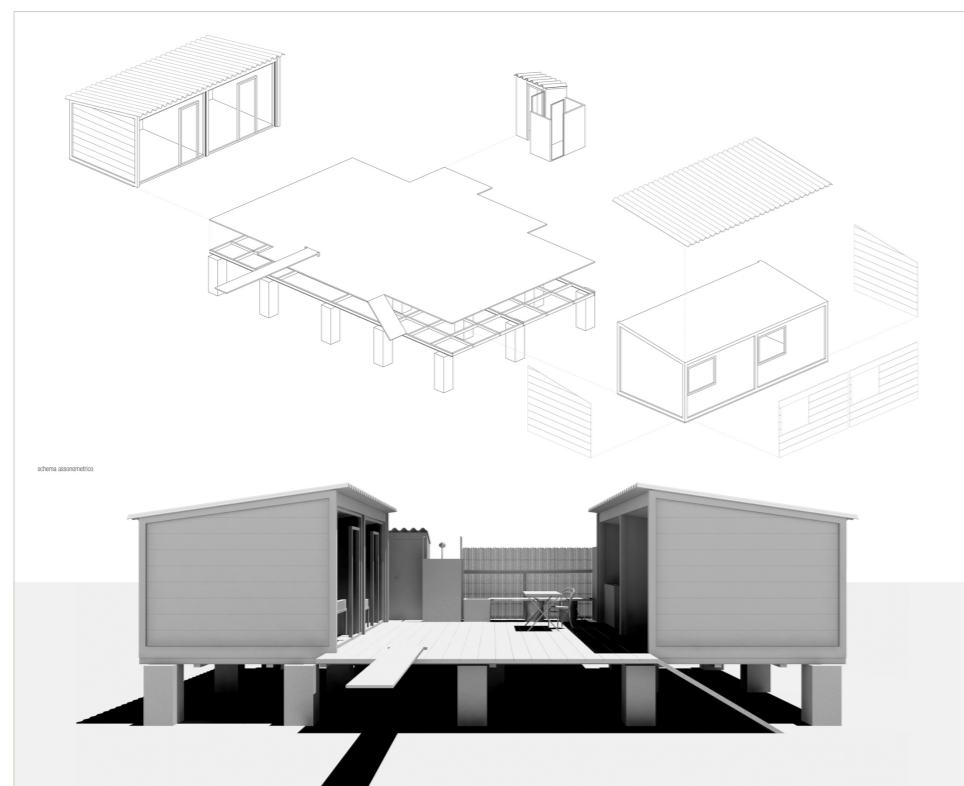

Fig. 3. Graphic interpretations of the 'Maison du week-end', Axonometric scheme and render. Graphic produced by the author.

The terrace was the living place, the real meeting place of the house. Wooden movable panels could isolate parts of the platform without removing the light or open to protect it from the sun and the rain. This smart cover system allowed to doubling of the floor space of the house. There were four movable provided panels. Each of them was independent of the other and enabled the partial or total isolation of the different rooms according to the needs of the tenants, as is evident from the sections. Through the plan you can also see that only two movable panels of the A volume show two little doors which allow the possibility to isolate oneself, while the B volume does not have this. This solution induces the tenants to come out of their indoor shelter and to enjoy the open space of the platform. Perriand, moreover, specifies the recommended orientation according to which the WC and the kitchen are on the north to protect the other spaces from cold winds, the parents' bedroom on the north-west, the children's bedroom on the south-west and the guest bedroom on the south-east. The rooms, placed in this way, are visually connected by diagonals which intersect and translate in movement axes. The first diagonal lies between the two stairs, one of which is in the garage and the other goes towards the river. A second diagonal axis lies between the living area of the platform and the diving board. The parallel axes that connect the parents' bedroom to the kitchen and the children's to the guest bedroom emphasise the role of the bridge-platform.

The axonometric scheme permits one to better capture the spirit of Charlotte Perriand's idea (Fig. 3). The fireplace, the garage, the diving board, the barbecue and the WC, are all elements that show

how Perriand was trying to offer every possible comfort through simple and inexpensive solutions, following not only an economy of volumes but also of materials.

From the A-A and B-B sections one can ascertain much information about rotating panels, their operation, the covers as well as way of life that Charlotte Perriand was trying to introduce with this plan (Fig. 4). From the C-C section it is evident that the placing of the WC on the platform gives an added value to the whole project. This section is also useful to make clear the height of the wooden panel which separates the two bedrooms of the A module which, unlike that in the B module, only partially separates the two rooms without the guarantee of soundproofing.

Her solution to resolve the problem of the natural slope of land is interesting. Presenting her proposal about a slope, she demonstrates how this plan could be available to every place, because the main structure is completely free from the ground below.

At the same time, Perriand employs this aspect to place the garage below the platform. This solution clearly reveals the influence of Le Corbusier in her work. As in his *Villa Savoye*, the car has its own role in the house. Since the modern family uses the car as principal mean of transport, Charlotte Perriand explains that here, as in every residence, there will be a specific place to shelter it.

Perriand's experience in planning houses like these, examples of minimal and economic price architecture, was important because it introduced her to the fundamental rules of human life in a limited space and also because it made her fight for flexible, new and practical solutions useful for her future works. Through this plan, she emphasised a collective and rational way of life. Her work, in fact, reflected her age tendencies towards economy and prosperity of the middle classes. Through *habitation minimum*, she found new directives for integration and safeguard of public health. Besides the influence of Le Corbusier's residences in Weissenhof especially for the organisation of inner spaces inspired by the sleeping car, Charlotte Perriand was affected by other innovative architects of that time.

About twenty years before, in 1913, Adolf Loos wrote the rules to follow for the mountain buildings:

Do not build in a picturesque manner. Leave such effect to the walls, the mountains and the sun....Pay attention to the forms in which the locals build. For they are the fruits of wisdom gleaned from the past. But look for the origin of the forms. If technological advances made it possible to improve on the form, then always use this improvement....Be true! Nature only tolerates truth.<sup>5</sup>

<sup>5</sup> Adolf Loos, *Die potemkinsche Stadt: Verschollene Schriften 1987–1933* (Vienna: Adolf Opel, G.Prachnercop, 1983), 16.

Therefore, Perriand refused the total integration with the environment based on natural shapes; on the contrary she presented rational shapes that declared their artificiality and she approached the natural through the use of organic materials.

In her autobiography, she wrote:

Architecture proceeds from interior towards exterior, it is a coming and going movement. It must satisfy our needs, offer us the extension of our daily gestures, both in a house, in a hospital, in an embassy... It is necessary to keep in mind the man in his individual or collective dimension and his habits, his idiosyncrasies, the society in which he lives, the climate, the environment.<sup>6</sup>

In her plans, Perriand introduced some basic but innovative concepts, such as the use of high technology materials in different combinations, the emphasis on improved interior comfort, the sizing and rationalisation of spaces, the cooperation between factory and handicraft, and the packing speed. All these elements confirm the diachronic universality of her solutions.

Starting from the minimum, she reached the whole, keeping in mind that the new social conditions required houses for a modern, practical and independent man and woman. Even if many her works were not realised, she revealed a fresh methodology of a free and a creative mind.

<sup>6</sup> Perriand, *Io, Charlotte*, 28.

**Giorgia Gaeta**

Università degli Studi di Palermo, Dipartimento di Architettura D'ARCH  
University of Palermo – Department of Architecture



Giorgia Gaeta (1985), graduated in Restoration of Architecture in 2009 and in Architecture in 2015, with a thesis entitled "Charlotte Perriand. Graphic interpretations," at the University of Palermo. She is interested in the study of women pioneers' projects of the Modern Movement and she has published her articles at some international conferences about representation of unbuilt architecture.

E-mail: [gaetagiorgia@gmail.com](mailto:gaetagiorgia@gmail.com)



## Redrawing as Key to the Spatial Thought of Hana Kučerová Zaveská

This paper analyses two works of Hana Kučerová Zaveská, a Czech architect and designer who made an important contribution to the Modern Movement, dealing with social housing and social services and placing the emphasis on improving the status of women.

One of the first women to represent Modern Architecture at the Exhibition of Contemporary Culture in Brno in 1928, with *Villa Balling* she contributed, as the only woman, to the edification of the Baba district in Prague, presented at the residential architecture as a field of experimentation with minimal houses.

From 1933, she worked on the summer residence for her parents in the district of Dobřichovice in Prague. Both villas exhibit great flexibility through a renewable and modifiable space. In addition, the furniture has been designed for each room of the house, in a simple and convenient way, to promote the liberation of women from unnecessary home work.

Hana Kučerová Zaveská was able to re-read the history of architecture, managing to develop solutions that are still among the best examples of 'feminine architecture'.

This redrawing projects Hana Kučerová Zaveská through new and unreleased representations and graphical analysis provide to an original key to the spatial thought of the architect.

Keywords: representation, Hana Kučerová Zaveská, Modern Movement, redrawing, graphic

This paper analyses two works of Hana Kučerová Zaveská, Czech architect and designer who made an important contribution to the Modern Movement, through social housing and social services that placed emphasis on improving the status of women.<sup>1</sup> Her brief, but intense, activity was developed in Czechoslovakia in the period between the wars and was influenced by the architecture and art movements that occurred in that country during the twenties and thirties.<sup>2</sup>

At that time, young artists identified with Cubism to express the new social reality and architects abandoned the anachronistic forms of stylistic revivals and decorativism for a new architectural language that expressed new spatial forms.<sup>3</sup>

In the footsteps of Marcel Breuer and Mies van der Rohe, she created furniture where functionality was combined with elegance and in which we recognise her signature style in the innovative use of materials and production methods.

One of the first women to represent Modern Architecture at the Exhibition of Contemporary Culture in Brno in 1928, Hana Kučerová Zaveská is called by her teacher, Pawel Janek, for the edification of residential district Baba in Prague, presented at the residential architecture as a field of experimentation with minimal houses. The district had to be an example of the modern lifestyle,

1 Part of this paper is the synthesis of a larger work converged into Valeria Cinnirella's Graduation Thesis, Supervisor Prof. Francesco Maggio. Valeria Cinnirella, "Hana Kučerová Zaveská. Architettura funzionalista in Cecoslovacchia" (Graduation Thesis, University of Palermo, 2015).

2 See Anna Beková and Danielle Monsimier, *Praga e Cecoslovacchia* (Verona: Edizioni Futuro, 1990); Marie Benešová, *Česká architektura v proměnách dvou století* (Praha: Odborná, 1984); Marco Biraghi, *Guida all'architettura del Novecento a Vienna, Budapest e Praga* (Milano: Electa, 1998); Ivan Margolius, *Prague: A Guide to Twentieth-century Architecture* (London: Artemis, 1994); Zlatý Rez, *Prague 20th Century Architecture* (Vienna, New York: Springer, 1999).

3 See Marie Benešová, "Architettura cubista in Boemia," *Casabella* 314 (1967), 68–71; Francois Burkhardt, "Appunti sul cubismo nell'architettura cecoslovacca," *Lotus International* 20 (1978), 54-62; Francois Burkhardt and Milena Lamarová, *Cubismo cecoslovacco: Architetture e interni* (Milano: Electa, 1982); Milena Lamarová, "Cubismo ed espressionismo nell'architettura e nel design," *Lotus International* 20 (1978), 44–53.

which was also expressed in single-family houses characterised by modern architectural solutions.<sup>4</sup> With *Villa Balling*, Hana Kučerová Zaveská was the only woman to design for Baba.

Another significant project was carried out in 1933; this was the summer residence for her parents in the Dobřichovice district in Prague. Both villas exhibit great flexibility through a space that is renewable and modifiable as needed. In addition, the furniture designed for every room of the house in a simple, effective and convenient way, promotes the liberation of women from unnecessary homework. In these achievements, the influences of Le Corbusier are clear as are those of Adolf Loos.

Hana Kučerová Zaveská was able to re-read the history of architecture and the socio-economic changes that were affecting the rest of Europe, managing to develop solutions that are still among the best examples of 'feminine architecture'.

She was born in 1904 in Prague and studied at the School of Applied Arts in Prague when architecture was still considered a male prerogative.

During her studies in architecture, she began to work on the design and furniture for her sister's house in which we can see the influence of the Bauhaus. A typical element of her furniture is the wardrobe or built-in furniture, which is realised always in clear and clean shapes, from a simple and pure design, with minimalist finishing and with a simple and rational distribution of internal spaces.

When she finished her studies, she continued to be interested in furniture making for the UP Company, an important Czechoslovakian company, one of the best in Europe. Her furniture was the result of research on new design solutions for minimum dwellings; these are buildings that are easily and quickly realisable thanks to mass production, which also allows costs to be controlled.<sup>5</sup> Chairs, armchairs and sofas with a slightly inclined backrest of curved wood or with the tubular hardened steel frame, tables of minimalist structure in dark wood and with glass shelves, sofa beds with removable cushions and a space for the sheets, were displayed at the Exhibition of Contemporary Culture in Brno in 1928, for which she also designed a kitchen which makes good use of European research on minimal dwelling and manifested a great deal of attention on the work of women at home. Furnishing elements all have the same height to ensure the continuity of the shelves, and are arranged according to a 'U' scheme that allows the rationalisation of the spaces and, consequently, of the movements of the housewife who thus can have all tools handy. For the exhibition in Brno, she also made outdoor furniture in tubular chromed steel and wood that was later produced by Hynek Gottwald and made in yellow and red painted metal.

4 See Michael Kohout et al. (eds.), *Prague 20th Century Architecture* (New York: Springer Science & Business Media, 1999); Stephan Templ, *Die Werkbundsiedlung Prag* (Basel: Birkhäuser, 1999); Rostislav Švácha, *The Architecture of New Prague 1895–1945* (London: The MIT Press, Cambridge, 1995).

5 The development of industrial production and the changing housing conditions require new design solutions to meet the growing population of cities and new housing needs of the working class.

Subsequently, for the house of the engineer Pošlusnou Rudlovou, she designed an initial version of a fitted kitchen with built-in appliances, which, a few years later, she also implemented in the house of Miladu Zoubkovou-Vickovou.

Following the official announcement of independence of the new state of Czechoslovakia in 1928, Prague became its capital. The city spread very rapidly, also annexing municipalities until, at the end of the thirties, it had almost one million inhabitants.

The massive influx of new residents, who moved from the countryside in search of jobs and a better life, required solutions capable of responding to new housing needs.

Without a master plan, which was defined only in 1964, in the period between the two wars several neighbourhoods are constructed in Prague, inspired by the experiences of the rationalist vanguard in other important European cities.

In 1928, marking the tenth anniversary of national unity, the Brno branch of the Czechoslovakian Werkbund (*Svaz československého díla*), which promoted the development and dissemination of modern architecture and industrial design, organised in Prague the *Nový Dům* (New Homes), an important manifestation of modern architecture, conceived according to the example of international exhibitions held in Stuttgart, Wrocław, Karlsruhe, Vienna and Zurich. For that occasion, the construction of a residential neighbourhood in Prague was conceived, with houses that would help to improve the quality of life for working people. To achieve a healthy and functional living space, new structural solutions and new manufacturing technologies were developed. The neighbourhood was a showcase for the skills of modern Czech architects<sup>6</sup> but, unlike the Weissenhof in Stuttgart, it was not an experimental district. Conceived initially as a suburb of standardised houses, due to a financial crisis, the Baba neighbourhood, is constructed from 1932, thanks to the funding of private buyers who then demanded unique architecture, designed to measure and realised with traditional materials and technologies.

The master plan was commissioned by Pavel Janák, a leading figure of Czech contemporary art, who also selected the designers.<sup>7</sup> The program involved the construction of 33 single-family and duplex houses, most with gardens, arranged to have the same orientation to the south and the same view of the city. Flat roofs, white stucco and continuous windows are common to most of the buildings that, in response to the functionalist logic 'form follows function', are also characterised by strict lines and simple volumes. In the program's manifesto, Pavel Janák says,

6 See Giovanni Denti, *Praga: La voce grande della storia* (Firenze: Alinea, 2006), 98.

7 Pavel Janák, prominent theorist of Cubism in Prague, was a modernist architect who trained in Vienna with Otto Wagner. Lecturer at the School of Applied Arts in Prague, he designed and realised three houses in the Baba neighborhood.

The villas would “provide an overview of what a one family house can and should be, and how contemporary life dictates its layout, situation and size, lighting, heating, and the interior fixtures and fittings of individual rooms”.<sup>8</sup>

Hana Kučerová Zaveská was invited to participate in the construction of the Baba neighbourhood by Pavel Janak, who was her teacher and with whom, after her studies, she had undertaken a collaborative relationship. The assignment concerns the construction of the villa Suková and the villa for Karel Baling, composer of popular songs.

The *villa Baling* is located on grounds of 108 square meters with a slight slope and, despite the limited size of the lot, the architect designed a functional building on multiple levels.

The laundry and boiler room were located in the basement and the upper floors allocated to housing, to avoid direct contact with the ground and to ensure a clear view over Prague.

The villa consists of a parallelepiped with an overhanging volume in the northwest corner, to which aligns and stands a smaller and lower volume that contains the entrance. Flat roof, simple geometries, large openings, flat surfaces free of decorations and straight lines characterise this villa, like the others of Baba.

The villa is on three levels above ground and is complemented by a walkover terrace, which is the coverage of the entire volume (Fig. 1).

A staircase, inside the house and located along the north wall, gives access to all floors. Two external staircases, placed at opposite corners of the house, north-west and south-east, link the ground floor with the garden in the basement. The one-flight staircase to the southeast allows access to –via the garden level to the basement– an overhanging terrace to the ground floor, supported by spindly Mannesmann tubes piles, on which the large living room opens. A canopy hooked to the façade, provides shading in the summer months and allows the use of the terrace as an outdoor dining room.

The living room is accessed from street level through an entrance centrally located on the northern front on the ground floor.<sup>9</sup>

The distribution of the rooms on the ground floor shows that the location of the services area and the garage is to the north, and the residential area to the south. The latter is designed as a single large room, changeable depending on the different housing needs and divided into three parts - a study area, a living room and a dining area directly connected to the kitchen.<sup>10</sup> Through the entrance, a large hall is the hinge on which stands the inner staircase and the garage to the

Fig. 1. Hana Kučerová Zaveská, Villa Baling in Prague, 1932, plans. Drawings by Valeria Cinnirella.

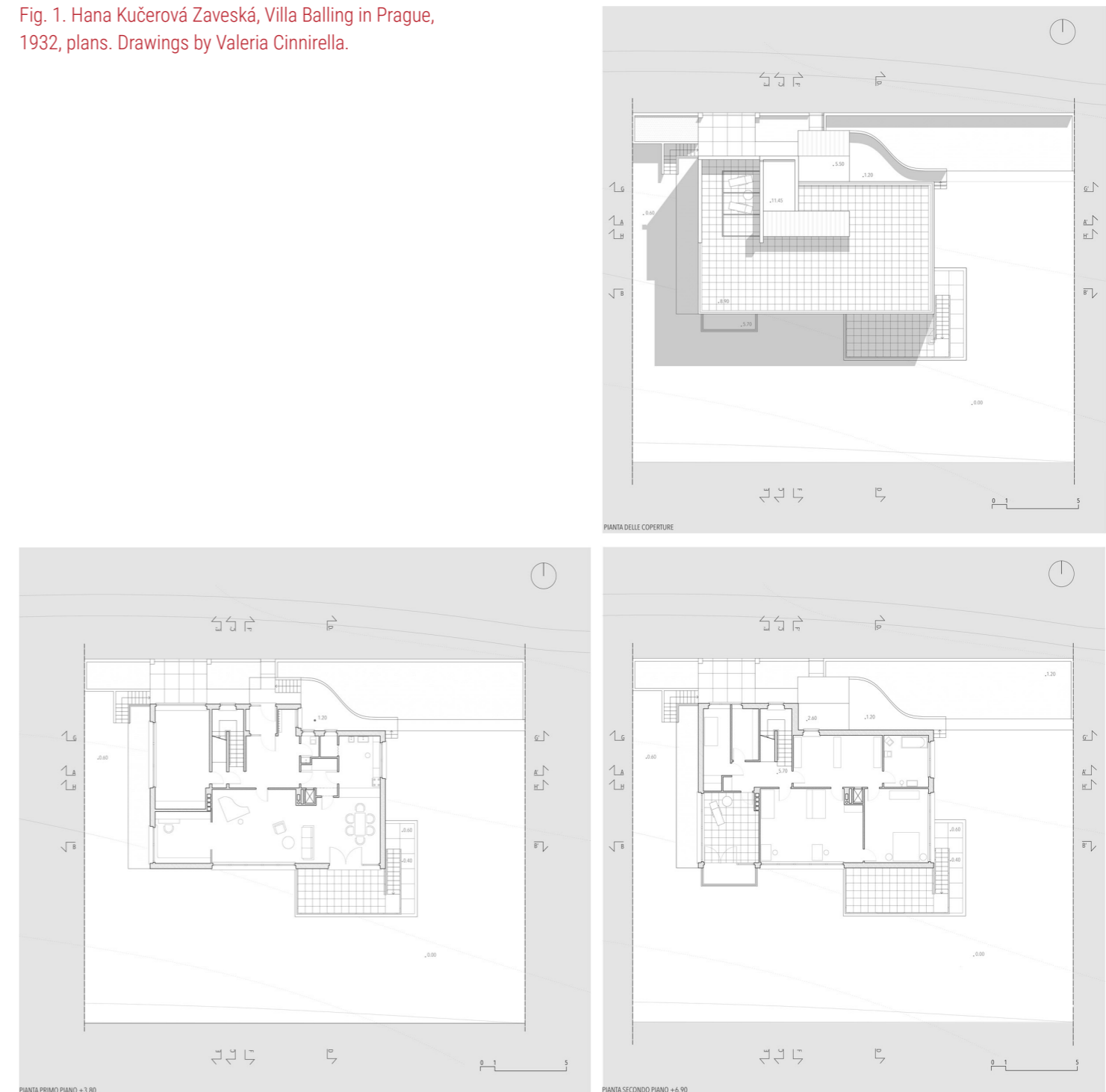

8 Jane Pavitt, *Prague* (Manchester: Manchester University Press, 2000), 110.

9 The staircase separates the garage at the entrance.

10 The flexibility of the living space is an important issue for Hana Kučerová Zaveská to which end she often designed custom furniture.

west, kitchen, wine cellar and services to the east, and the large living room to the south. One can access the kitchen via a further filter space in which there are a large closet and a freight elevator that connects the first three levels to carry the linen from the laundry to the kitchen to a large walk-in closet on the second floor.

The entire first floor is the sleeping area. To the south in a central position, there is a large children's room with two single beds, which can be accessed through two separate doors; the room is divided in two by the appropriate use of a cabinet that serves as a partition wall. To the southeast is the master bedroom and to the south-west a winter garden with a terrace that opens to the south. To the north, the staircase separates the large dressing room and bathroom from the servants' quarters that sit above the garage.

Through the internal staircase, one can reach the roof garden terrace (Fig. 2). The wall of the projecting volume that contains the staircase to the north exceeds the level of the last floor to wrap and protect the angle to the north-west, which is more intimate area of the terrace, probably destined to be a solarium. A covered area includes the zone reserved for drying.

For the *villa Balling*, Hana Kučerová Zaveská also designed the furniture, conceived as an integral part of a whole work of art which is her architecture. The integrated and functional furniture is tailored for each space. The use of sliding walls ensures, throughout the day, flexible environments that can be completely open or closed and private, ensuring a smooth organisation of the activities of the house.

The façades are geometric compositions drawn from solids and voids, and compact surfaces engraved by essential openings (Fig. 3). They are characterised by openings of varying size and shape, depending on the different requirements for illumination and ventilation of the interior. The size of the openings appear commensurate to those of the environments and to their function.

The drawing of the railings of the terraces and exterior stairs is shown by the repetition of tubular elements horizontally arranged, as in many buildings of the Modern Movement.

The redrawing of *villa Balling*, made from the published drawings and photographs, also includes the assumption about the arrangement of furniture, taken from the original drawings available and from the vintage photos.<sup>11</sup>

The axonometric and perspective views, obtained by digital model, reveal a game of solids and voids, a clever use of terraces and balconies, volumes and surfaces that move the composition (Figs. 4 and 5). Certainly *villa Balling* is the 'manifesto' of the functionalist poetic of Hana Kučerová Zaveská and reflects the influences exerted by the models of Le Corbusier.

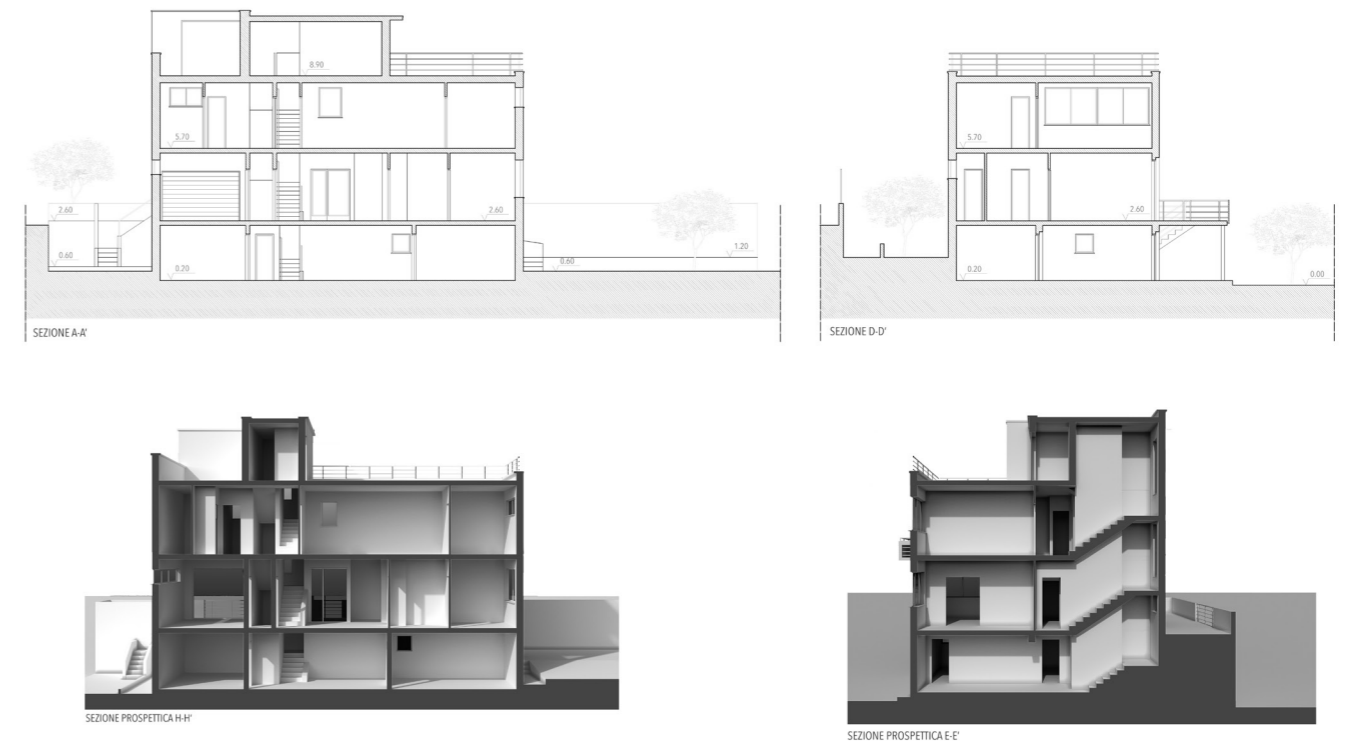

Fig. 2. Hana Kučerová Zaveská, Villa Balling in Prague, 1932, sections and sectional perspective views. Drawings by Valeria Cinnirella.

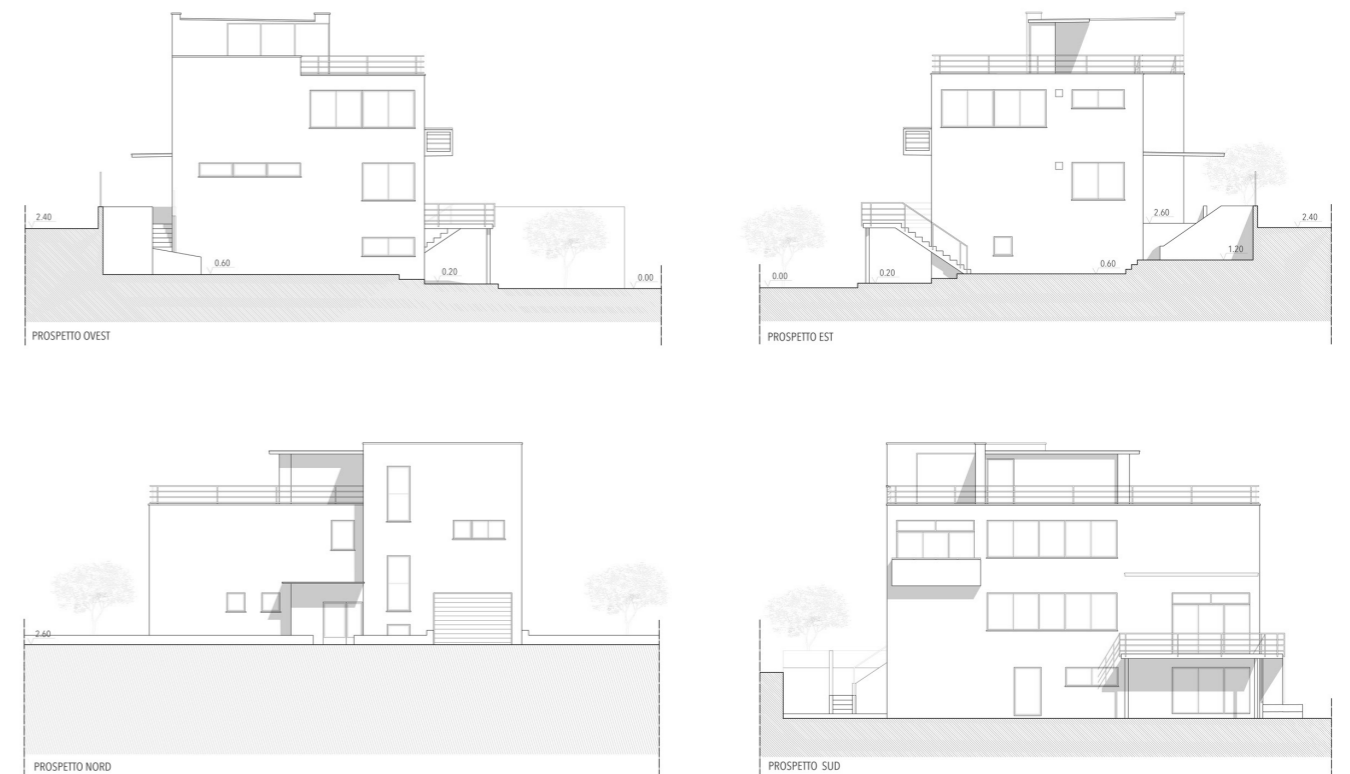

Fig. 3. Hana Kučerová Zaveská, Villa Balling in Prague, 1932, fronts. Drawings by Valeria Cinnirella.

<sup>11</sup> On vintage magazines only plans of the ground floor and the first floor, the drawing of the main facade and some photographs are published.

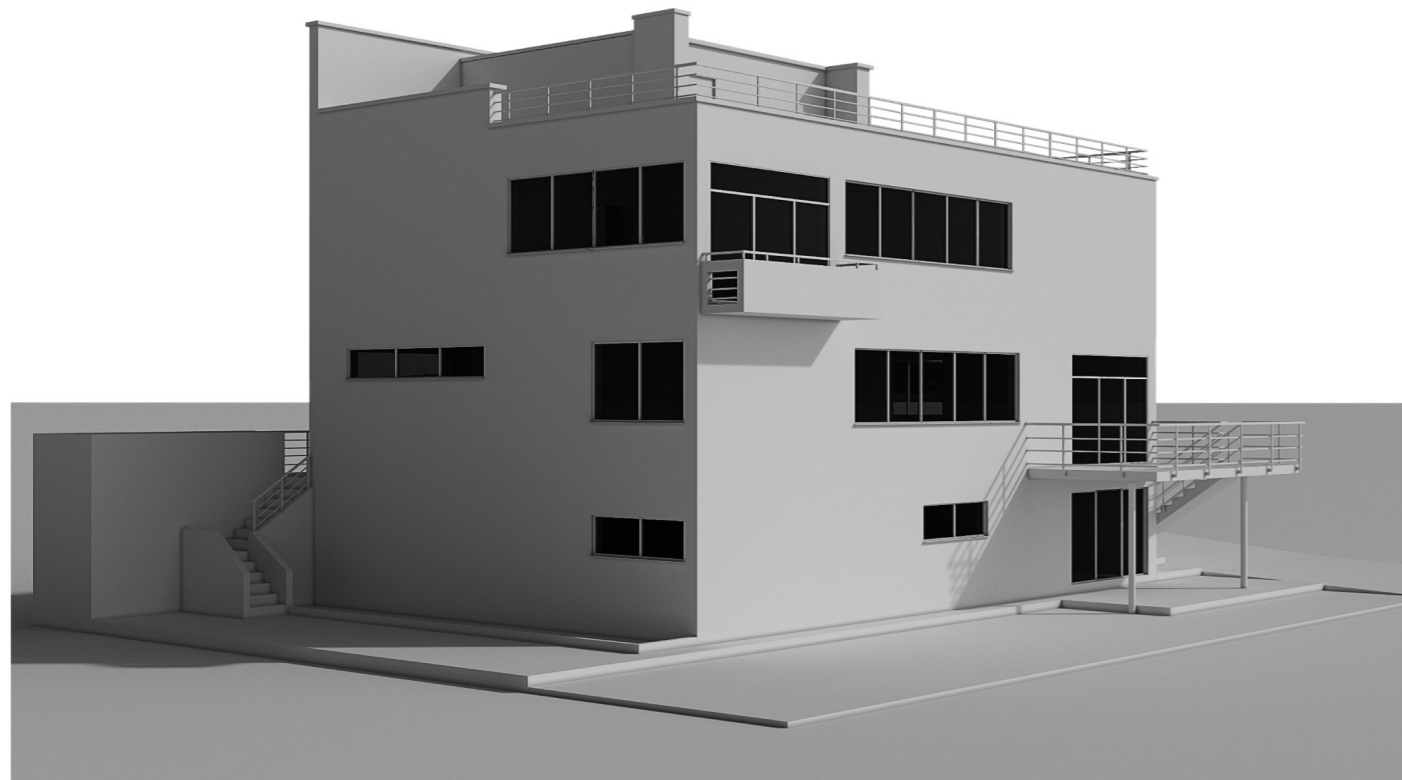
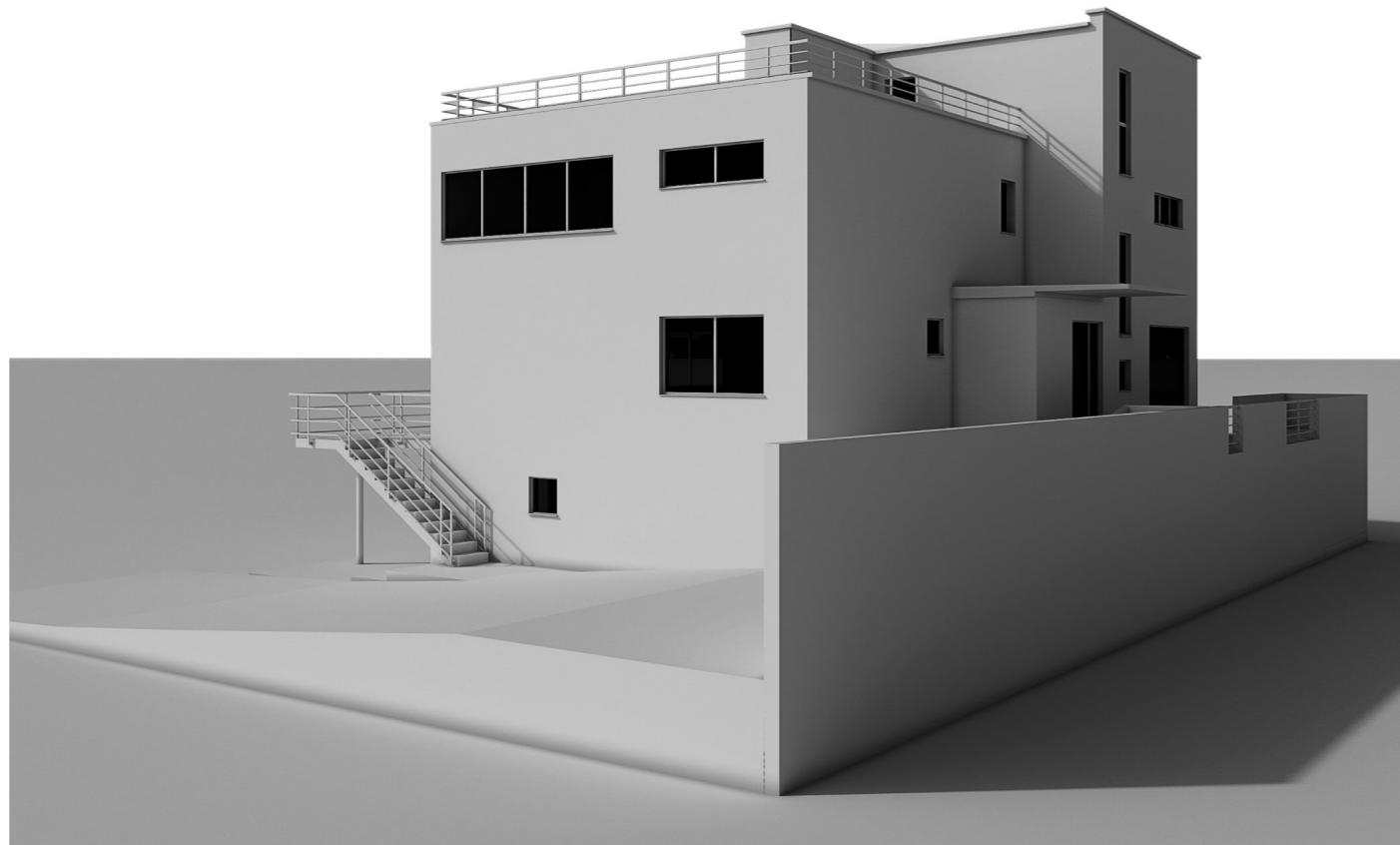

Fig. 4. Hana Kučerová Zaveská, Villa Balling in Prague, 1932, 3D models. Drawings by Valeria Cinnirella.

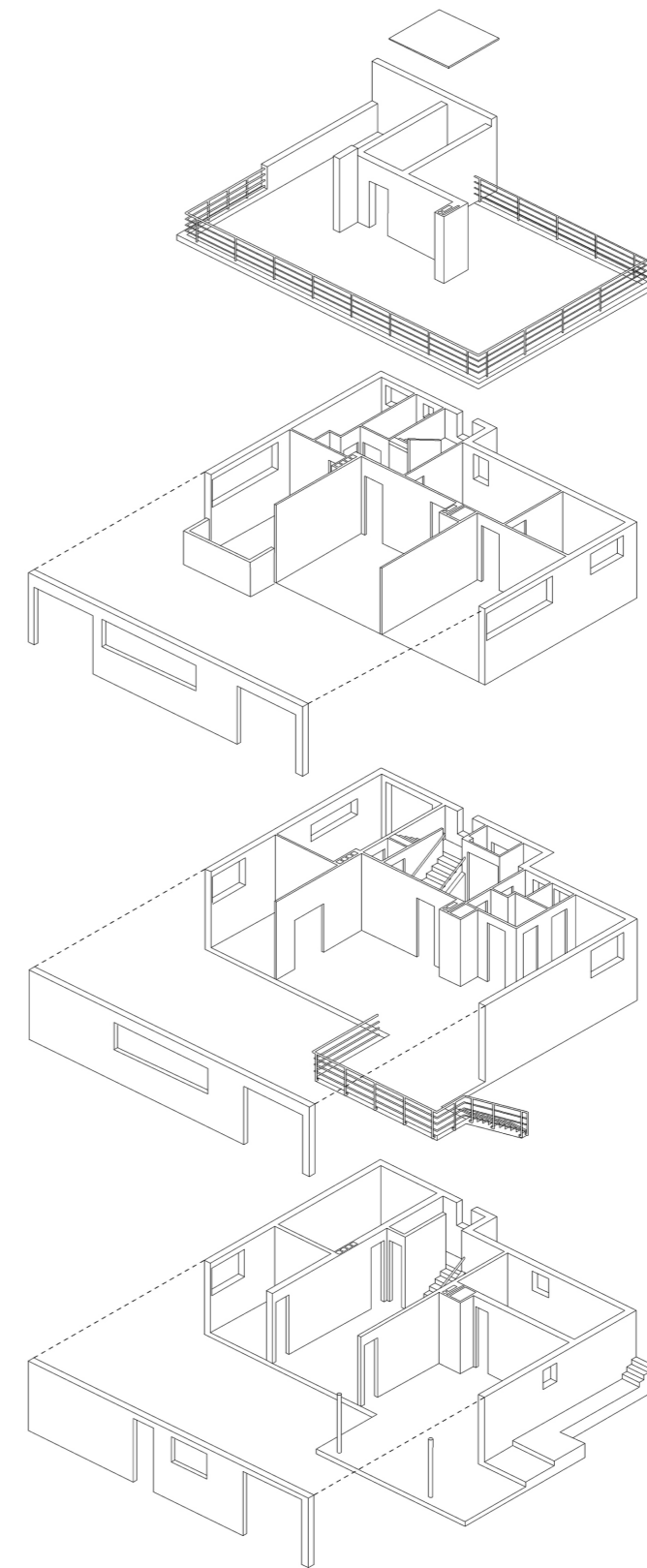

Fig. 5. Hana Kučerová Zaveská, Villa Balling in Prague, 1932, exploded axonometric view. Drawings by Valeria Cinnirella.

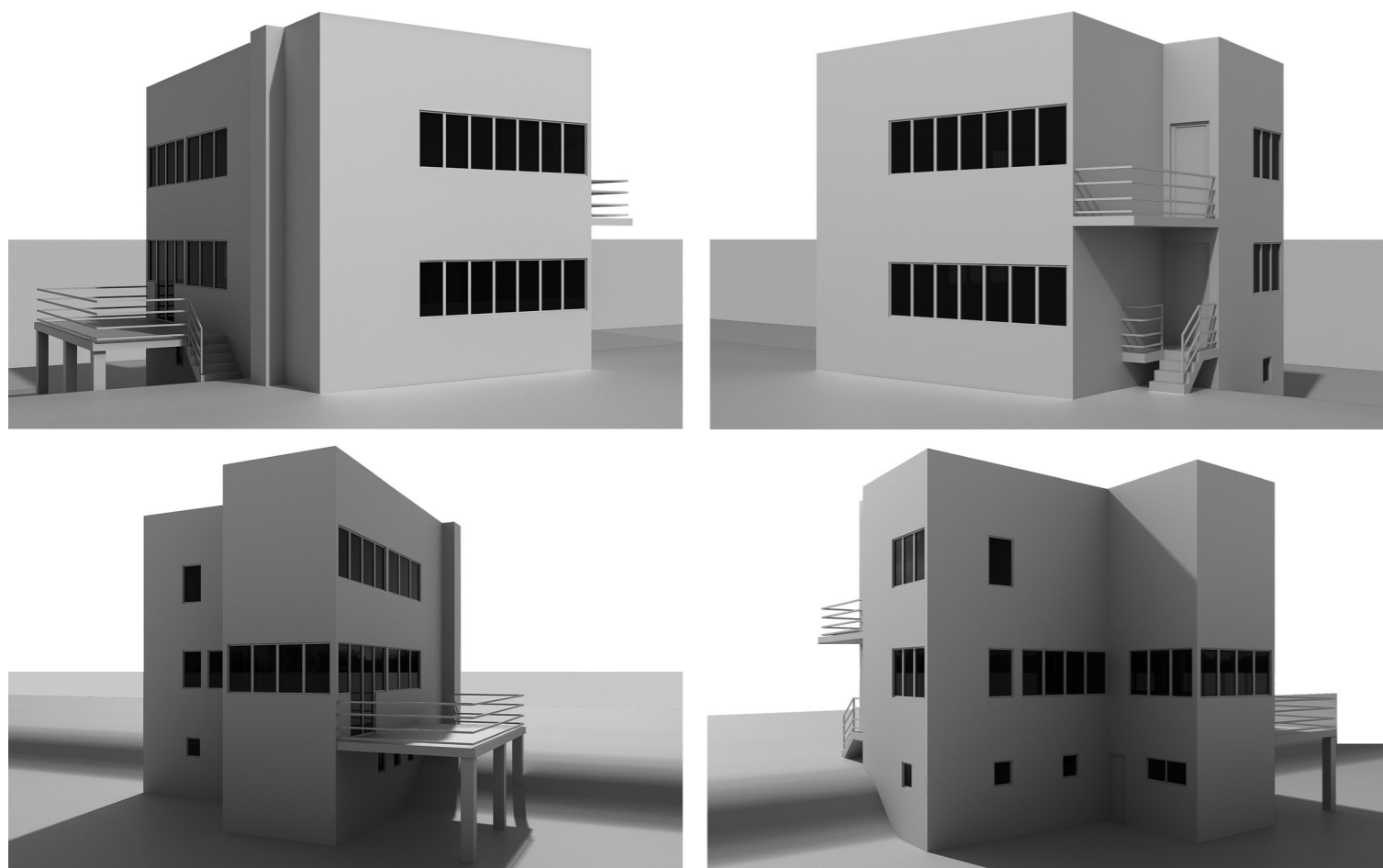

Fig. 6. Hana Kučerová Zaveská, Villa for parents Olga and Maximilian Zaveskych in Dobrichovice, 1933, 3D models. Drawings by Valeria Cinnirella.

Between 1933 and 1934, she designed and built the summer villa for her parents, Olga and Maximilian Zaveskych, in Dobrichovice. The attribution of authorship of this project is uncertain<sup>12</sup> and the only documents received concerning the villa are the original drawings and the technical report kept by Zuzana Vojtová, grandson of the daughter of Hana Kučerová Zaveská.<sup>13</sup>

The villa, built on a slope, has two floors above ground level, a basement that occupies the drop of about 2.80 m and a roof terrace living space. It has a steel structure, which is pressed, plastered and straw coated.

The building consists of a compact and articulated volume with smooth, continuous surfaces, interrupted by large openings and from which protrude a large terrace on the ground floor to the north-west and a balcony on the first floor that visually reconstructs the angle diagonally opposite corner to the southeast (Fig. 6).

<sup>12</sup> The design drawings carry the signature of the engineer Duchoslavem.

<sup>13</sup> The documentation guarded also includes the project for a garage to be realized on the edge of the site. It is dated 1934 and bears the signature of Czech architects Lva Krč and Stanislava Tobeka.

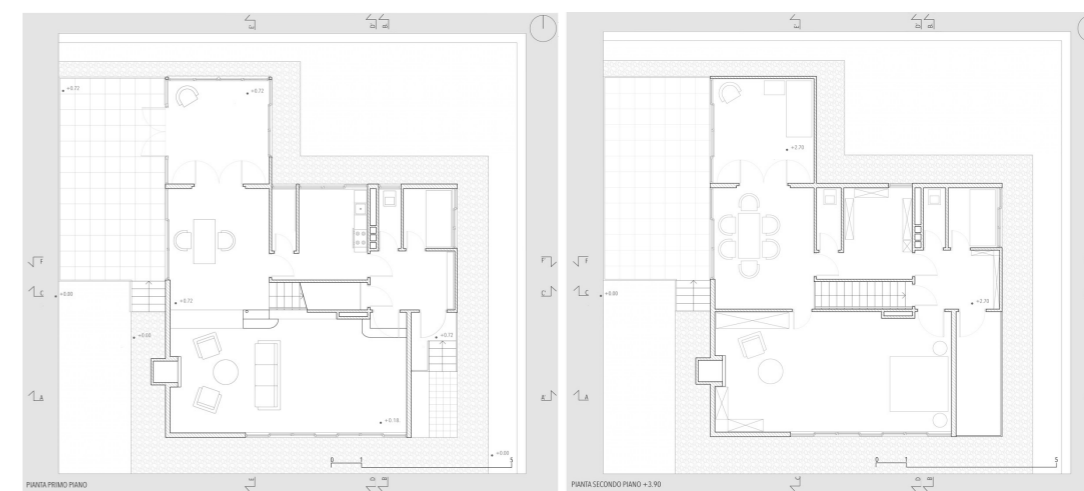

Fig. 7. Hana Kučerová Zaveská, Villa for parents Olga and Maximilian Zaveskych in Dobrichovice, 1933, plans. Drawings by Valeria Cinnirella.

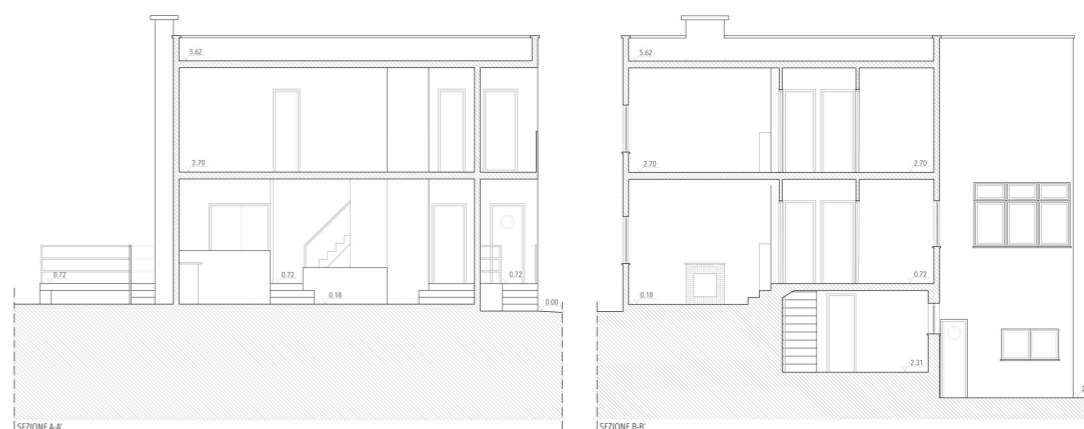

Fig. 8. Hana Kučerová Zaveská, Villa for parents Olga and Maximilian Zaveskych in Dobrichovice, 1933, sections. Drawings by Valeria Cinnirella.

The entrance to the villa on the ground floor is located to the south, in a recess of the volume and is covered by the balcony's first floor that serves as a shelter (Fig. 7). To access one must cross a small drop bridged by a ramp with five steps. One can access a hallway of which there are a utility room, a bathroom, a kitchen, a large compartment under the stairs, and the living room occupying the south area and whose tread surface dimension is lower than 70 cm compared to the rest of the plan. The west wall of the living room is characterised by the presence of a fireplace and the volume of its chimney juts outward from the west front going vertically from the ground up to the roof terrace. Through the kitchen, one arrives in the dining room which is located in the west of the house and is directly connected with the living room to the south and with the winter garden to the north. Through the latter you reach a large terrace, supported by three pillars, from which, through a ramp with five raised stairs, one arrives at the level of the ground below.

The inner staircase, which connects all levels, is at the centre of the house (Fig. 8).

The first floor includes the sleeping area. The arrangement of the partitions does not vary between the ground and first floor. Here, in correspondence with the large living room, there is the master bedroom, which occupies the entire south wing of the floor and has a fireplace and located above the winter garden is another bedroom.

The basement is in the north of the building, at the lower ground level (Fig. 9). Its drawing on the plan is given by a rectangle along the east-west axis which is partially flanked a square to the north-west. As there is a vertical drop of about 50 cm, these are placed at two different heights to accommodate the difference in ground level. This level includes the equipment rooms, laundry and boiler room. It is directly accessed from the level of the garden or from the ground floor, through the inner staircase, which connects all levels of the house.

The roof terrace is accessible through two external ladders. The first, very narrow, runs vertically to the entire north façade, from the level of the ground; the second directly connects the first floor balcony to the east with the covering floor.

Contrary to the *villa Balling*, here the types of frames used are reduced (Fig. 10). The north, south and west facades are characterised by a marked presence of ribbon windows at the ground floor and at the first one, while small openings identify the presence of bathrooms and all the basement windows. On the north, east and west facades higher windows point out and characterise the presence of the winter garden. As with *villa Balling*, the terrace, the balcony and the entrance staircase have railings realised by the repetition of four tubular elements, horizontally arranged and painted blue.

In this case, Hana Kučerová Zaveská oversaw the design of part of the villa's furniture. Some furniture, as in the *villa Balling*, help to define spaces and functions, such as the dresser placed between the living and dining room that isolates –physically but not visually– the two

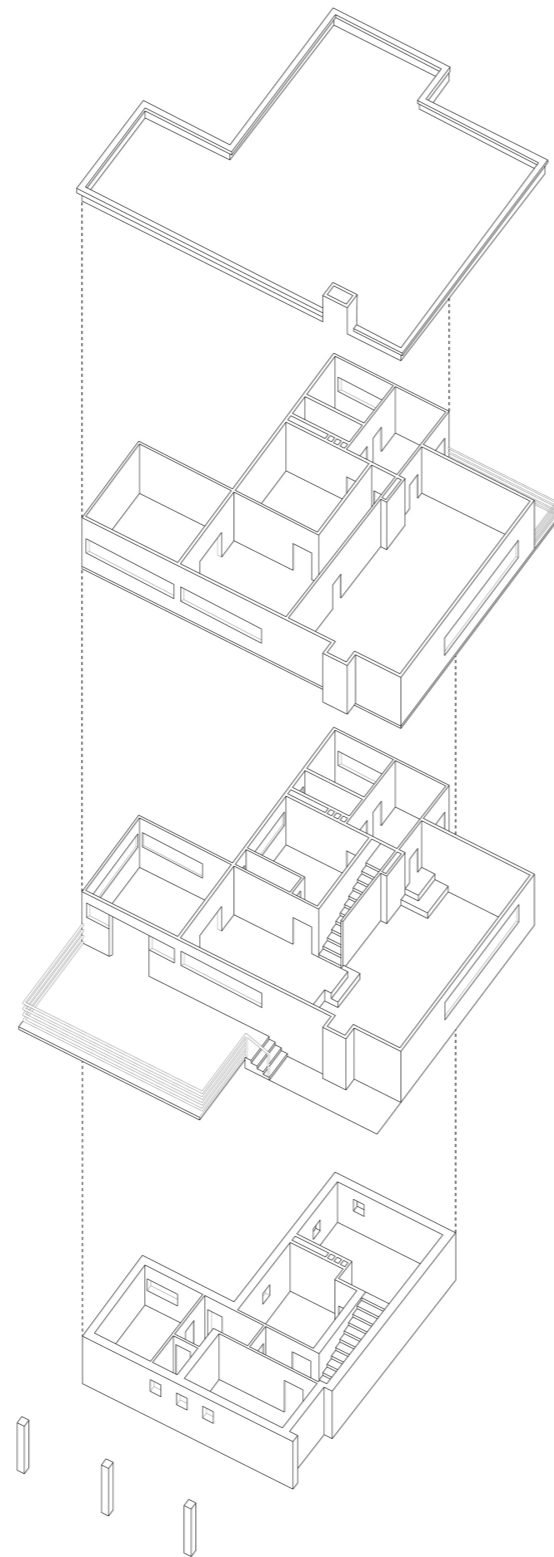

Fig. 9. Hana Kučerová Zaveská, Villa for parents Olga and Maximilian Zaveskych in Dobrichovice, 1933, exploded axonometric view. Drawings by Valeria Cinnirella.



Fig. 10. Hana Kučerová Zaveská, Villa for parents Olga and Maximilian Zaveskych in Dobrichovice, 1933, fronts. Drawings by Valeria Cinnirella.

functions and partially fills the difference in height between the two areas, or as in the case of the bookcase with the tea table that separates the staircase from the living room. Particular attention was given to the kitchen, organised in modern American style with appliances, cabinets, and drawers at hand, in order to facilitate the work of women.

The projects of Hana Kučerová Zaveská are here told through the representation of Monge projections and by three-dimensional digital reconstruction. The drawings made for this essay transcribe the available graphic documentation, derived from original works and with the help of published photos. The path of knowledge, aimed at understanding of the architectural organisms here analysed as a whole, and in relations between the parts, accomplished by redrawing and analysis of the houses, has led to a process of abstraction, synthesis, choice of sign, and element hierarchy to represent.

The isometric and perspective projections, derived from digital models, describe the architectures drawn by Hana Kučerová Zaveská and they reveal the spatial dynamics, trying not to betray the original qualities.

Redrawing the projects of Hana Kučerová Zaveská through new and unreleased representations and through graphical analysis, endeavours to provide an original key to the spatial thoughts of the architect.

**Vincenza Garofalo**

Università degli Studi di Palermo, Dipartimento di Architettura D'ARCH  
University of Palermo – Department of Architecture



Vincenza Garofalo, Architect, Researcher in Representation at the University of Palermo since 2014. She received her PhD in Surveying and Representation of Architecture and the Environment from the University of Palermo. Since 1996, she has carried out architectural and archaeological surveys in Italy and researches in Surveying and Representation of Historical Architecture participating in national and international research projects and presenting the results at national and international conferences. Her research also concerns the study of modern unbuilt architecture through representation and graphical analysis. Since 2003, she has taught Representation of Architecture and Digital Communication of Architecture and Landscape.

E-mail: [vincenza.garofalo@unipa.it](mailto:vincenza.garofalo@unipa.it)

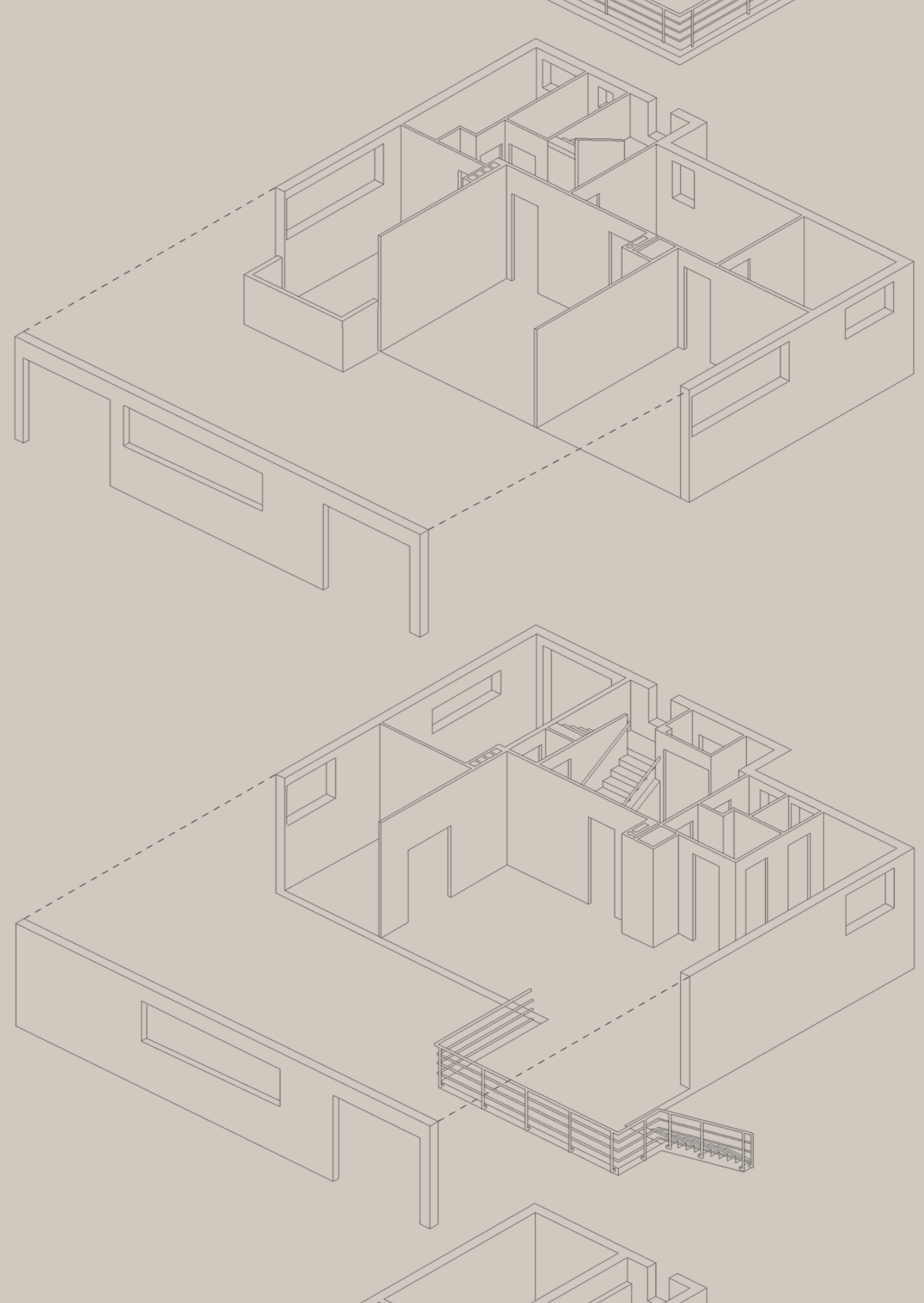

## Lina Bo Bardi: Unbuilt in Sicily

In August 1940 the magazine *Domus*, in a special issue dedicated to the *casa al mare*, publishes the project of the *Casa sul mare di Sicilia* by Lina Bo Bardi and Carlo Pagani. It was one of the first projects of Lina Bo, a utopian project whose representations indicate a way of proceedings that coagulates theory and imagination conceived as an indissoluble relationship of 'doing'.

Add to the 'unconventional' drawings of the project, plans, perspectives and perspective section, indicating a very personal way in the use of graphic language, we can find a synthesis' drawing that underlines how the representation is intended both as an extension of the mind, and as order structure of a speech.

It is a project, which because of its visionary character, contains an idea of landscape, living, relationship with the history, that a possible realisation would not allow it to take shape with such expressive intensity. This paper deals with a graphic reading of the dwelling designed by Lina Bo through new digital representations that not only implement the existing graphic corpus but also try to retrace the project's ways that often the word, entrusted to architectural criticism, cannot identify.

If this sentence is true, then the drawing conceived as analysis and then as a critical tool, is the medium between words and things.

Keywords: history, representation, unbuilt, Sicily, digital

Eclectic character, architect, scenographer, urban planner, designer and also illustrator, Lina Bo, from the early years of her youth, has revealed a particular inclination towards drawing manifested by her watercolors produced when she was eleven years old that testify to the need to represent the world and especially the idea that we have of it.

A watercolor of 1929, painted at the age of fifteen, on *Piazza Montanara* (Fig. 1), as well as showing the ability to modulate the sign to highlight the plans sequence, describes, through the expression of the subjects' faces, the human condition that the square welcomed.

The urban space described by the young Lina has been destroyed, and her watercolor is witness, along with vintage photos, of an image of a lost Rome.

Worth here transcribing the description of the square –which comes from the network *Roma Sparita - Storia e Cultura-* to emphasise the close union between the literary text and architectural image:

In Rome there was a small picturesque square of which there is no longer trace: Piazza Montanara. It was located close to the remains of Teatro di Marcello, between Via Montanara and Vicolo del Teatro di Marcello, stretching almost to the church of San Nicola in Carcere, from which only a little block separated it, and with a system of bystreets it was linked to what is now Piazza Bocca della Verità. It was a very picturesque square. Rural people arrive there: stewards, foremen, yokels, peasants, corporals... the whole hierarchy of the countryside was represented by a colorful humanity made of women dressed with the bust covered in red apron and striped blouse, and of men in clumsy clothes but with the inevitable hat.

Then there were the strolling players, the laborers who came to look for seasonal work, who often camped overnight in the crevices of the square to be ready early in the morning to be hired and starting with their shovels and hoes on their shoulders, singing.



Fig. 1. Lina Bo Bardi, *Piazza Montanara*, 1929, watercolor. Published in Marcelo Carvalho Ferraz (ed.), *Lina Bo Bardi* (Milano: Edizioni Charta, 1994).



Fig. 2. Enrico Bo, *Piazza Guglielmo Pepe*, oil. Published in Marcelo Carvalho Ferraz (ed.), *Lina Bo Bardi* (Milano: Edizioni Charta, 1994).



Fig. 3. Lina Bo Bardi, watercolor. Published in Marcelo Carvalho Ferraz (ed.), *Lina Bo Bardi* (Milano: Edizioni Charta, 1994).

The popular Roman voice, with that sense of superiority that always has characterised it, called them *burini*. It is believed that the square's name derived from this type of frequentation. Actually, Montanara is the name of the fifteenth century family, then died out, who first began to build in the square.

With such frequentation could not miss in the square also flourishing small commercial activities such as grocery store, haberdashery, peddling of alcohol, the sale of fabrics and hats, hardware. While preferred exercise outdoors surgeons and tooth-puller or scribes. Famous was the *barbiere della meluccia* who used mouthing customers a small apple, always the same, while shaving, for tending their cheeks. The last customer of the day could eat it.

Belli left us, in his verses, the indelible memory of some characters of the square: the scribe, who exercised in the square calling and declaiming his skills, but also the *Santaccia*, a prostitute rather famous.

This whole world was completely destroyed between 1926 and 1934 for the construction of Via del Mare (now Via del Teatro di Marcello) and the reorganisation of the entire road network and enhancement of the Colle Capitolino. This whole area, including the current Piazza della Bocca della Verità, underwent a radical transformation and it is now quite complex to figure out how it had to be this area.<sup>1</sup>

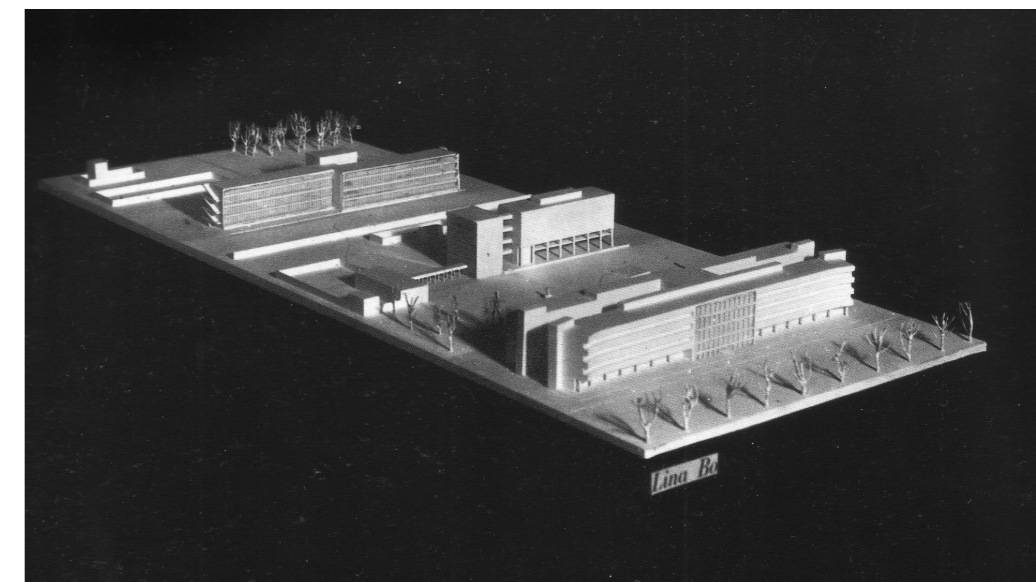

Fig. 4. Lina Bo Bardi, Thesis, 1939, model. Published in Marcelo Carvalho Ferraz (ed.), *Lina Bo Bardi* (Milano: Edizioni Charta, 1994).

The telling of the square's history harmonises well with the watercolor of the young Bo Bardi because every drawing of Lina points to a possible literary text unwritten, evokes memories, and urges imagination.

Lina Bo's peculiar way of representing had certainly not originated through a 'natural talent' but, most likely, referred to the artistic sensibility of her father, Enrico Bo, anarchist with an adventurous life, dotted with many trades. He was the owner of a factory toys, graphic artist, builder in Rome largely of the popular Testaccio district. One need only look at the oil painting by her father, *Piazza Guglielmo Pepe* (Fig. 2), to trace representational similarities with the drawings of his young daughter (Fig. 3). The personal and professional experience of Lina Bo Bardi is an original and exciting aspect in the history of modern architecture.

She graduated in 1939, almost twenty-six, from the Faculty of Architecture of Rome with a thesis about the project of a building for assistance for mothers and children (Fig. 4), in a period when the Roman school, led by Marcello Piacentini and Gustavo Giovannoni, focused its interest mainly on the historical disciplines rather than on projects. She first moved to Milan, where she worked with Giò Ponti and Carlo Pagani, and a few years later to Brazil, her second homeland.<sup>2</sup>

Immediately, after her graduation, in August 1940, the *Domus* journal, in a special issue dedicated to the 'beach house', she published the project of *Casa sul Mare di Sicilia*<sup>3</sup> by Lina Bo Bardi and Carlo

<sup>1</sup> "Roma Sparita – Piazza Montanara," *Roma Sparita: Storia e Cultura*, <http://www.romasparita.eu/storia-cultura/279-roma-sparita-piazza-montanara> (accessed June 16, 2017).

<sup>2</sup> '1951. Mi sono naturalizzata brasiliana. Quando si nasce, non si sceglie niente, si nasce per caso. Non sono nata qui, ho scelto questo posto per viverci. Per questo, il Brasile è due volte il mio Paese, è la mia 'Patria di Scelta', e io mi sento cittadina di tutte le città, da Cariri al Triangolo Mineiro, alle Città dell'Interno e a quelle di Frontiera.' Lina Bo Bardi, "Curriculum letterario," in Marcelo Carvalho Ferraz, *Lina Bo Bardi* (Milano: Edizioni Charta, 1994), 12.

<sup>3</sup> Lina Bo Bardi and Carlo Pagani, "Casa sul mare in Sicilia," *Domus* 18 (August 1940), 30–35.



Fig. 5. Lina Bo Bardi and Carlo Pagani, House in Sicily, 1940  
Published in Lina Bo Bardi e Carlo Pagani, "Casa sul mare in Sicilia," *Domus* 18 (Agosto 1940).

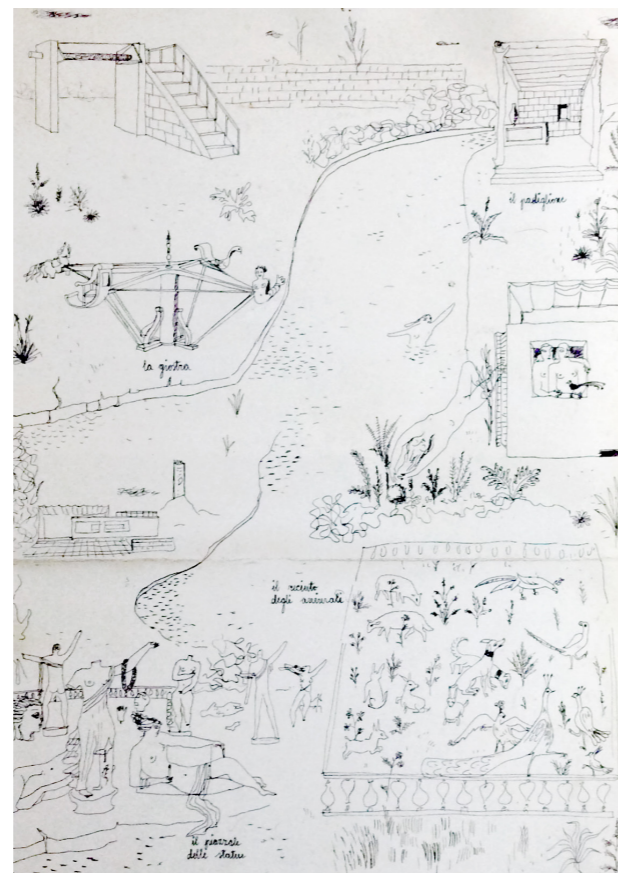

Fig. 6. Lina Bo Bardi and Carlo Pagani, drawing unknown.  
Published in Marcelo Carvalho Ferraz (ed.), *Lina Bo Bardi* (Milano: Edizioni Charta, 1994).

Pagani. It is one of her first projects, a sort of real debut, a utopian project whose representations indicate a way of proceeding that coagulates theory and imagination conceived as inseparable relationship of 'doing architecture'.

Add to the 'unconventional' drawings' project, plans, perspectives and perspective section, indicating a very particular manner of the graphic language used by Lina Bo, a synthesis drawing (Fig. 5) which emphasises how the representation is intended both as an extension of the mind and as the order structure of a dialogue that relates architecture to the elements of culture of the Magna Graecia. This representation recalls another drawing that relates to *Studio per un giardino*, also made with Carlo Pagani, published in the catalog of an exhibition on Lina Bo Bardi organised in 1993 in São Paulo by the Lina Bo Institute and P. M. Bardi (Fig. 6).

The similarities between the two drawings are very clear. The topic of the fence, the drawing of the balustrade, the roof garden with the same curtains, the statues that refer to the Magna Graecia, and especially, in the upper right corner, the central perspective of a brick and wood pavilion are absolutely identical to the one in the *Casa in Sicilia* project. This perfect similarity leads to two different reflections. The former, according to which the published drawing in the catalog may refer

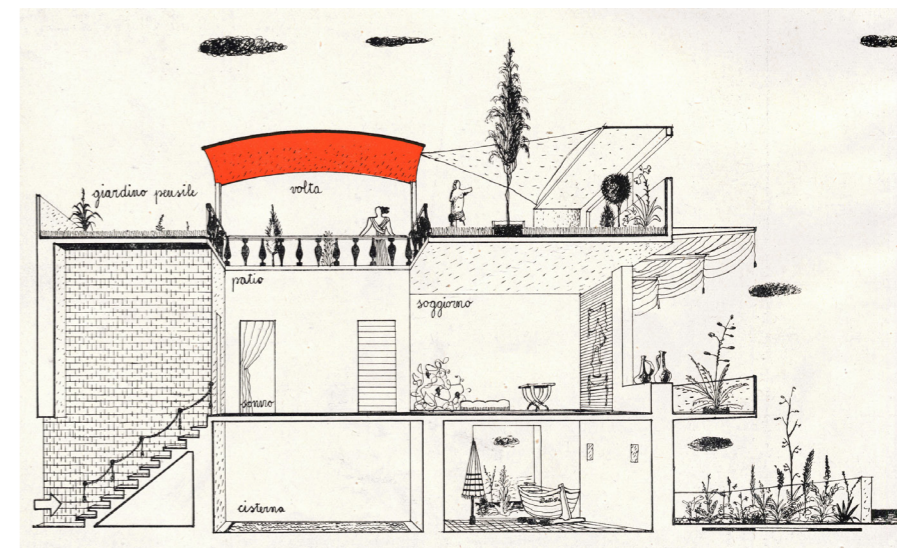

Fig. 7. Lina Bo Bardi and Carlo Pagani, House in Sicily, 1940, perspective section.  
Published in Lina Bo Bardi e Carlo Pagani, "Casa sul mare in Sicilia," *Domus* 18 (Agosto 1940).

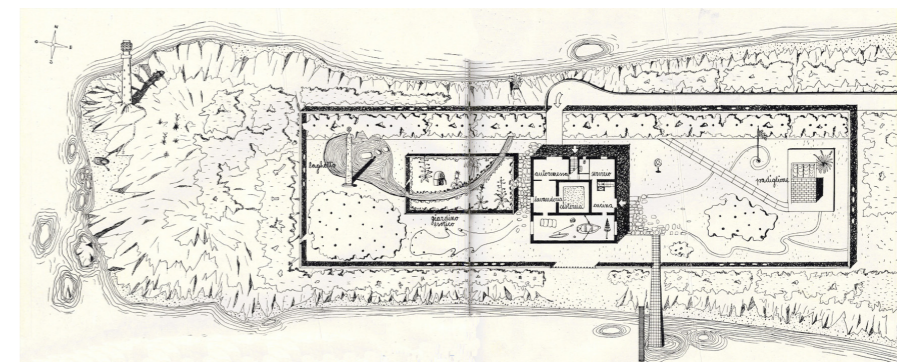

Fig. 8. Lina Bo Bardi and Carlo Pagani, House in Sicily, 1940, plan.  
Published in Lina Bo Bardi e Carlo Pagani, "Casa sul mare in Sicilia," *Domus* 18 (Agosto 1940).

is the project in Sicily and concerns the drafting of an initial project proposal; the latter, perhaps the most plausible, is that an architect, actually owning his/her own figurative repertoire, uses the elements of his/her 'catalog' in similar spatial situations to that where the element has been used.

The design of the *Casa in Sicilia*, for its visionary character, contains an idea of landscape, living, relating with the history, that an eventual realisation would not allow it to take shape with such expressive intensity.

The house, on two levels, is set almost centrally, behind a fence whose shape is that of a 'stretched' rectangle, as if it was the combination of two diagonal rectangles  $\sqrt{3}$  derived from the square on the short side. The fence is surrounded by high white walls that 'create, under the blinding sea and rock of Sicily painting, an atmosphere of rest, an atmosphere of immense summer silence'.<sup>4</sup>

Indeed, by observing the perspective section drawn by the authors (Fig. 7), it is clear that the height of the wall of the fence is small and, therefore, it is in contrast with the words in the text

<sup>4</sup> Bo Bardi and Pagani, "Casa sul mare," 31.

accompanying the description of this house; here the drawing shows its strength, all its significant power. The drawing, as language, in its contiguity with the word, includes and excludes stresses and deliberately hides.

The house is thought of as the 'alteration of the earth's crust' of a small promontory whose margins are formed by steep rocks in which grow and creep wild shrubs, a prerogative of the sunny seascape of Sicily. A high lighthouse stands at the tip of the promontory almost to guard the house.

The general layout (Fig. 8) is the representation that, besides the graphical composition of figure 5, provides more to the imagination the elements of a poetic 'building'. The use of shadow gives cognizance of volumetric relationships and of the consistency of the elements as well as informing about the harmony of the composition. The strict formal layout of the fence, the rectangle  $\sqrt{3}$ , the house, a square, the exotic garden, another rectangle, the pavilion, another square, contrast with the meandering of the stream that flows into a small pond, small walkways that lead to the obelisk and to a pavilion and a walkway of random inclined arrangement, also leading to the pavilion. Within the fence of the exotic garden stand hibiscus plants, euphorbia, cactus and palm trees and two huts, the memory of the primitive hut indicating, probably, the concept of living.

The representation's system of the general plan, as well as other orthogonal projections that tell the project, does not perfectly follow the rules of the representation science because there is the presence of representation in plan and elevation; into the drawing, indeed, the lighthouse, the obelisk, the umbrella into the shed and the spherical astrolabe are represented in vertical projection. Within the exotic garden, however, the hut is shown in axonometric projection.

Taking shape as a real utopian hypothesis, this project, on paper, strongly expresses the idea of living and in this respect references the Heideggerian thought according to which

building and thinking are always, each in their own way, inescapable for dwelling. Both, however, are also insufficient for dwelling until they separately wait for their activities, without listening to each other. They can do this when both, the building and the thinking, belong to the living, remain within their limits and know that the one and the other come from the workshop of a long experience and a relentless pursuit.<sup>5</sup>

The plan of the house, at the entrance height, already has a strict formal layout and the correspondence of the alignments among parties is mainly determined by the use of load-bearing masonry. The ground floor includes the garage, the laundry, the kitchen, the private quarters of housekeeper, a large boathouse and storage for equipment related to recreational marine activity. The central space, a square in the square, contains the tank probably entrusted to collect rainwater. A path above the rocks can bring the boat into the sea and adjacent is a quay for mooring.

The access to the main floor of the house is via a staircase with a ramp located centrally on the north side of the driveway entrance, and from it you can reach the covered central patio, a clear nod to the Greek house to which the authors make explicit reference. The patio is the centerpiece of the house because 'around it unfolds life and life converges there'.<sup>6</sup> The master bedroom with dressing room and bathroom with oval tub face to the east, and to the west are a room with two beds and the office which is connected to the kitchen below by a staircase and a small elevator. To the south the large living and music space is furnished with a big bed for a guest, with the piano and the dining table set against the west wall; a sliding door, with equal dimensions to those of the square patio's side, allows a close relationship between the two spaces. The perspective sections (Fig. 9) evidence this relationship from the point of view of the connection between the parts. From visual perception of the interior we gather, in a single glance, many central elements of the project: the sharpness of white walls, the scarlet red of the wall's patio, background of the head of an ancient excavation horse, the relationship with the blue sky, with the seascape, with the overlooking volcanic islands in eruption; small vessels of different shape, resting on the windowsill of the large window, reminiscent of the forms of Greek pottery.

A long terrace, adjacent to the longer side of the living room allows a view of the sea and a volcano, probably Stromboli Island. From the terrace, through two symmetrical staircases posed to the east and west, one reaches the roof garden: 'Here, there is the rest in the sun or in the shade of the sail stretched over the soft flowery meadow. All around myrtle bushes and cactus plants grow between slabs of lava; graphite here and there.'<sup>7</sup>

The south façade, in its essence, informs us of the base and the tripartite division of the openings of the first floor and the roof garden almost recalling the rhythmic rigor of the base, of the stem and entablature in the architectural order.

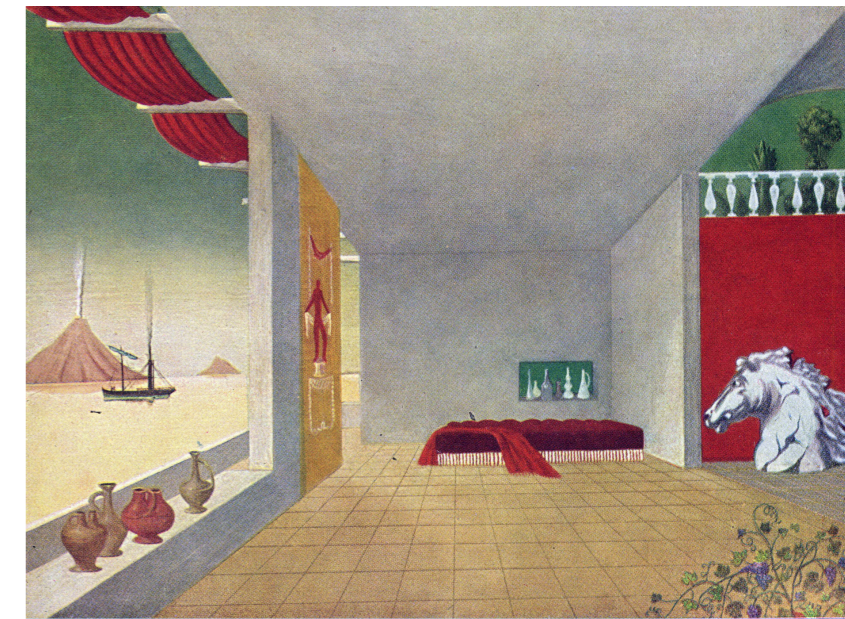

Fig. 9. Lina Bo Bardi and Carlo Pagani, House in Sicily, 1940, perspective section. Published in Lina Bo Bardi e Carlo Pagani, "Casa sul mare in Sicilia," *Domus* 18 (Agosto 1940).

<sup>6</sup> Bo Bardi and Pagani, "Casa sul mare," 30.

<sup>7</sup> Bo Bardi and Pagani, "Casa sul mare," 31.

<sup>5</sup> Gianni Vattimo (ed.), "Costruire abitare pensare," in *Saggi e discorsi* (Milano: Mursia, 1976), 107–108.

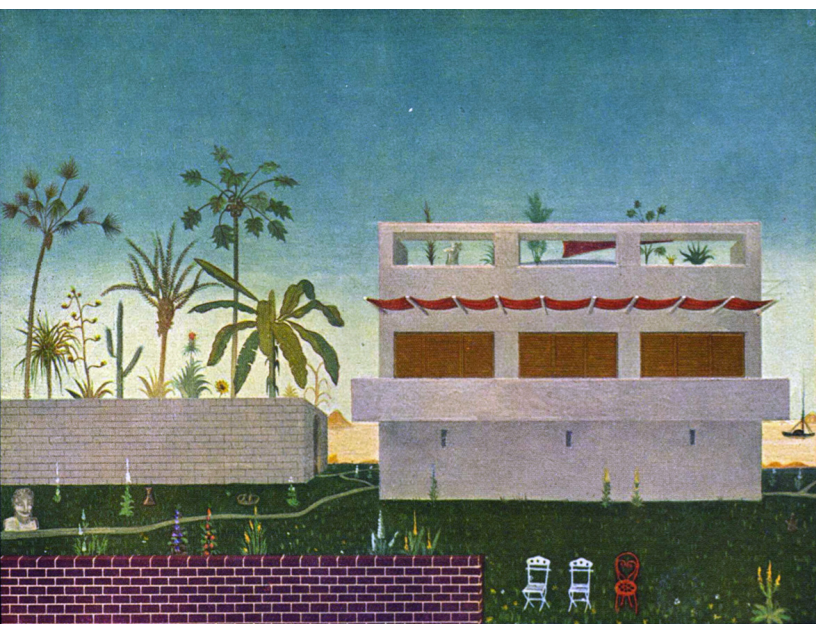

Fig. 10. Lina Bo Bardi and Carlo Pagani, House in Sicily, 1940, perspective.  
Published in Lina Bo Bardi e Carlo Pagani, "Casa sul mare in Sicilia," *Domus* 18 (Agosto 1940).

As Sarah Catalano rightly says, certainly looking at the façade (Fig. 10), 'the architectural language used is rationalist, in a Mediterranean version, showing attention to local weather conditions and to the relationship with the landscape: a stereometrically defined pure volume, smooth and white surfaces, marked by large openings that open to the sea.'<sup>8</sup>

The topic of the Mediterranean is one of the central themes of architecture critics who operate in the Mediterranean basin and who track this character even in European architecture built during the Modern Movement, especially by those architects who came very often to Italy.

To summarise the salient aspects of this character it seems appropriate to refer to

the words of Nicola Marzot that, very clearly, outline the significant traits:

The Mediterranean can express and reveal to the observer at different levels, which form the possible invariant, each of which plays a crucial role in the qualification of public space, connoting it formally and historically. The first level is related to the way in which the architecture relates to the ground, whether it is natural or artificial. In this sense, the Mediterranean architecture does not 'rest' in order to preserve intact the primitive morphology, but it 'turns into space' in the ground, becoming an integral part, almost resulting in mineralized landscape. In the first case, exemplified by a settlement of rule of the classical temple, an 'additive' logic prevails, filling the natural space of objects, each of which retains its intrinsic characteristic, sublimated by the condition of mutual detachment evoked by the role of the stylobate. In the second one a logic of 'subtractive' character prevails transforming the morphology of the support, natural and/or artificial one, through architecture, altering its character by virtue of a system of operations that interacts with inertia to the modification of the same support, recalling the original meaning of *templum* as 'clearing', evoked by Heidegger as an emblematic 'place'. In the first case the architecture 'gives itself' regardless of the presence of the landscape that includes it and that pre-exists, for contrast and/or difference, while in the second one the architecture 'reveals itself', in the Heideggerian sense, through the system of operations conducted on the

landscape itself, whereby the one and the other include each other through interaction. The archetype of a 'subtractive' attitude than to the landscape is the cave, as the result of a primitive 'removal' operation of matter from the living body of the natural landscape. Symmetrically, that original gesture, in a metonymic process, is inscribed on the rough inner surface of the atrium, determining the circumstantial character, that is the ability to present (and not to represent) without any form of mediation its own construction and transformation process. In its original formulation, the Mediterranean architecture is characterised therefore by elementary operations of transformation of the primal ground. The process by which it generates is comparable to that of sculpture, plastic, by way of 'digging' paraphrasing Michelangelo. [...] A fourth aspect is related to a trend aspiration of Mediterranean architecture to identify itself with the landscape in which it is going to include, in continuity with its morphology, without giving up to its own abstracting character. Thus nature and artifice become complementary factors associated within a vision of the world where natural and human forces are assimilated in common creative yearning, according to a romantic declination of architecture never completely died down.<sup>9</sup>

To investigate some aspects of the project, it was appropriate to target the cognitive process by the redrawing of it, a kind of mimesis, in reverse, of the compositional process. Indeed, the drawing is one of the tools of architectural criticism, and when it investigates a project in *absentia*, becomes a real act of interpretation. This consideration allows you to drive out an old basic misunderstanding for which the architecture drawing is only a tool intended as a simple means and not as something refined, used to achieve a purpose.

The new representations, perspectives, sections and perspective sections, outcomes of an hermeneutic and then identifiable in *Vorstellung*,<sup>10</sup> have been produced since the drawings were published in *Domus* in 1940. They do not only provide new unpublished images of the project, but they are helpful for new 'readings' that indicate an action project that consists of the coexistence of theory and practice in the compositional process of Lina Bo, whose figures combined in a single architectural view, the house, the town and the landscape.

The drawing, as the proper place of architectural criticism, is a tool that allows, more so than any other, to get closer to the recognisable consistency of the design process for its continuous 'coming and going' that is characteristic of both the drawing and the form's construction, which, without it, cannot take 'body'. Therefore, the drawing conceived as analysis and critical tool, is the medium between words and things, which when 'drawn', provide the only survey instrument capable of retracing the critical points of the project, like the hidden ones, which the word often can identify only in an obviously different way.

8 Sarah Catalano, "Casa sul mare di Sicilia: Progetto d'esordio di Lina Bo Bardi e Carlo Pagani," *Salvare Palermo* 22 (2008), 19.

9 Nicola Marzot, "Architetture scolpite: Alcune invarianti del paesaggio mediterraneo," *Architettura* 7-8 (2003), 25-26.

10 The deutsch term *Vorstellung* indicates representation as a purely interpretative action.

To reconstruct the thought of Lina Bo Bardi, through the reconstruction of some unbuilt projects, it is necessary to rely on digital representation, as it allows multiple hermeneutic manifestations.

The construction of the digital model is the logical consequence for the verification of the project's intentions, not only because the model contains the expressions of the 'translator', in this case those who re-draw, but above all because it allows you to view all the problems that would arise if those representations were materialised in a true, real, architectural 'body'.

We must intend the digital model as a 'starting point' for the graphical analysis of the architecture and not as its outcome; in fact, it is associated with other graphics, sometimes not derived from the model, useful for understanding of the architecture. The construction of the model is not an action of putting into the form a simple image that is an operation often carried out for the representation of the project, but it is the hermeneutic and critical result of the drawing substantially tending to the analysis of the shape.

Vincenzo Fasolo, at the end of the 1950s, in a collection of his lectures at the Faculty of Architecture of Rome, proposed:

the graphical analysis as a method for studying architecture, hoped a history of architecture drawn, rather than spoken [...] the method that we propose tends to arouse a self-examination of the architectural values in which in them is permanent so much for the ancient as for the modern. It is precisely a study about the ancient fact in function of the modern that will purchase a greater validity insofar as within it cross the experience and the nobility of ages of architects of high secular civilization. What now we are proposing does not go at the expense of the modern critical method; rather complements it, and it arouses the interest. Because this drawing is observing and then a thinking.<sup>11</sup>

We believe that, within the indissoluble relationship between drawing and design, the 'digital' representation can provide the history and architectural criticism of additional unedited files of images of unrealised architectures. The goal is ultimately to shed light on and re-build episodes in the history of architecture that are 'mute/silent' in their writing, and have found place only in the drawers of the archives or in the uncoated pages of books and magazines.

<sup>11</sup> Vincenzo Fasolo, "Analisi grafica dei valori architettonici: Lezioni del prof. Vincenzo Fasolo" (Rome: Università di Roma, Facoltà di Architettura, s.d.), s.p.

### Francesco Maggio

Università degli Studi di Palermo, Dipartimento di Architettura D'ARCH  
University of Palermo – Department of Architecture



Francesco Maggio, PhD, is associate professor of Representation in the Department of Architecture of the University of Palermo where he teaches *Laboratorio di Disegno e Rilievo* and *Disegno e Rappresentazione Informatica*. In the last few years, he has been interested in filling of archive drawings and in digital reconstructions of unbuilt architectures. He wrote the books *Architettura demolita* with M. Villa, *Eileen Gray: Interpretazioni grafiche* and *Triennale 1933* and the essays "Small Town Files. Lina Bo Bardi Unbuilt" and "Female Architecture: Unbuilt digital archive" with A. Franchina and S. Vattano.

E-mail: francesco.maggio@unipa.it



DOCUMENTA

Marjan Groot

## Interventions at the 1st MoMoWo Conference- workshop at the University of Leiden, the Netherlands

Four Practices, Four Women:  
Interviews with a Textile Designer,  
a Scholar of City Planning, an Industrial  
Designer-Engineer and an Architect

The 1st MoMoWo conference-workshop, held in September 2015 at the University of Leiden in the Netherlands, presented interventions by holding four interview sessions, one each day. During these interviews we discussed the work and experiences of invited guests about the position of women in design, architecture, and engineering.

First Intervention guest: [Christie van der Haak](#) (textile designer)

Second Intervention guest: [Ana María Fernández-Maldonado](#) (city planner)

Third Intervention guest: [Marlies van Dullemen](#) (designer-engineer)

Fourth Intervention guest: [Joke Vos](#) (architect)



The first Intervention Guest was textile designer Christie van der Haak

(<http://www.christievanderhaak.nl>).

Christie van der Haak lives and works in The Hague, the Netherlands. She studied design and fashion at the Royal Academy of Arts in The Hague, and after graduation became a painter. Her activities included painting ceramic plates with bold patterns, floral as well as other designs, merging painting and decorative art. Since 2003 she has been transforming her paintings into textiles with the help of a computer-controlled Jacquard weaving machine in the Textile Museum in Tilburg, the Netherlands. She has worked with a textile mill that produces wonderful upholstery fabrics and fabrics for wall coverings. Her work is manufactured both mechanically and manually, producing fabrics for mass production and unique fabrics that can be displayed on a canvas stretcher and shown as autonomous artworks at exhibitions. In her designs Christie tries to realise a combination of creating handicrafts in which the patterns are meticulously drawn and painted, and a method of mechanically producing a richness and intensity that is often lacking in today's fast commercial world.



Fig. 1. Christie van der Haak in her atelier. Photograph courtesy Christie van der Haak.



Fig. 2. Left: design installation by Christie van der Haak. Right: cover design for *Cactussen* by Jo Daemen, 1927. Photographs Christie van der Haak (left) and author (right).



Fig. 3. Gemeentemuseum The Hague (left) and lead image of the exhibiton 'Delfts Wit' ('White Delftware') with a fabric by Christie van der Haak (right), at <https://www.gemeentemuseum.nl/nl/tentoonstellingen/delfts-wit>, accessed 28 September 2017.

In the context of the 1st MoMoWo conference-workshop, Christie's works reflect the abstract nature of floral patterns by design reform movements from the 1870s to the late 1920s. Her work is a contemporary translation of these inspiring pre-modernist and modernist historical designs. Clients who buy her work recognise this tradition of decorative modernism in both its early and later stages, with the stylising of natural design motives that may be traced back to the British designer William Morris and the British Arts and Crafts movement between the 1860s and 1890s.

The MoMoWo conference connected her designs to a book cover from the late 1920s by the Dutch graphic designer Jo Daemen (Fig. 2). That design was made for a booklet about cacti and depicted bold blooming red flowers of a cactus. It was also used for the 1st conference-workshop book of abstracts. The design by Jo Daemen was chosen to challenge the firm grip of modernism on the literature of design history. That modernist grip seems to continue to have a hold on a group of designers and architects who for a long time were not well represented in the modernist canon: namely, women. Nowadays the canon of women designers still seems to be formed after the modernist ideology, as reflected in this conference. However, as many theorists argued since the 1980s, modernism as an ideology is still dominated by men. In addition, functionalist-modernism is not the only aspect of modernism. It has a multiplicity of forms. Christie van der Haak is aware of the position of women in this ideological minefield but she believes that she is primarily a designer and should continue to work as such, regardless of the prevailing fashion and discourse about design. Clients who appreciate her work are both men and women.

As far as Christie's work is concerned, people do realise that it is simultaneously new and contemporary. Over the years, she has made a lot of designs for upholstery, wall coverings,

draperies, tablecloths, table napkins and shawls. In relation to architecture she has executed large commissions in the Netherlands, notably for the Amrath Hotel chain and the Dutch Ministry for Foreign Affairs. The latter commissioned her to renovate Dutch embassies all over the world. She challenged the particular modernist spatiality of the building of the Gemeentemuseum in The Hague built in 1931-1935 after a design by H.P. Berlage, when she designed the 2013-2014 exhibition 'White Delftware' by covering the museums interior structure with colourful patterns. These patterns on columns formed a lively confrontation with the white Delft tin glazed faience from the late seventeenth and eighteenth centuries and with the white modernist museum spaces (Figs. 3 and 4).

Most recently an installation by Christie marked an exhibition on Modern Dutch design at the Wolfsonian-FIU in Miami Beach, Florida that was curated by Silvia Barisione. It offered a similar interplay with architectural volumes and spaces. Both the façade and the entrance hall of this Museum for Decorative and Propaganda Art were covered with different patterned sections. The colourful



Fig. 4. Christie van der Haak, Installation for the exhibition 'Delfts Wit' ('White Delftware') in the Gemeentemuseum The Hague, 23 November 2013-21 March 2014. Photograph author.



Fig. 5. The Wolfsonian-FIU, Washington Avenue 1001, Miami Beach. Original building 1926–1927 by Robertson & Patterson, renovated and enlarged by Mark Hampton in 1993–1995, and decorated with designs by Christie van der Haak for the exhibition *Modern Dutch Design*, November 2016–June 2017. The installation of the corner pattern (left) and the finished work (right). Photographs author, November 2016 and May 2017.

designs interacted with the Art Deco and modernist architectural environment surrounding this former 1927 warehouse on Miami Beach, enthusing many passers-by and museum visitors with their exuberant visual effect (Fig. 5).<sup>1</sup>

### Our second Intervention Guest was city planner Ana María Fernández-Maldonado

Ana María Fernández-Maldonado has worked as a senior researcher at the Spatial Planning and Strategy chair of the Faculty of Architecture of Delft University of Technology in the Netherlands since 1992. She informed the MoMoWo conference about her experiences in the planning of cities within her practice as an architect and urban designer in her own design office; in partnership with two other architects in Lima, Peru; as an urban planner in a district municipality in Lima; and as a

<sup>1</sup> For this exhibition see Marjan Groot, 'The Wolfsonian-FIU in Miami Beach and Modern Dutch Design', at <http://www.designhistory.nl/2017/the-wolfsonian-fiu-in-miami-beach-and-modern-dutch-design/>, posted 13 September 2017.

Fig. 6 Cover of *ICT-related Transformations in Latin American Metropolises* (Techne Press, 2004), by Ana María Fernández-Maldonado.

researcher into urban trends in informal settlements of Lima. Her research interest relates to planning and urban transformations of European and Latin American cities. This includes ICT-related transformations (Fig. 6), knowledge-based urban development, telecommunications and urban infrastructures, housing and planning policies and comparative studies. On first coming to the Netherlands she became aware that the problems connected with city planning in this country were very different from those in Peru. It seemed as if everything was perfectly arranged and no planning was needed at all. However, the geospatial situation of both Peru and the Netherlands gives them different urgent issues to deal with and solve with regard to city planning. A comparative perspective is most helpful in focusing on commonalities and differences and coming up with solutions.

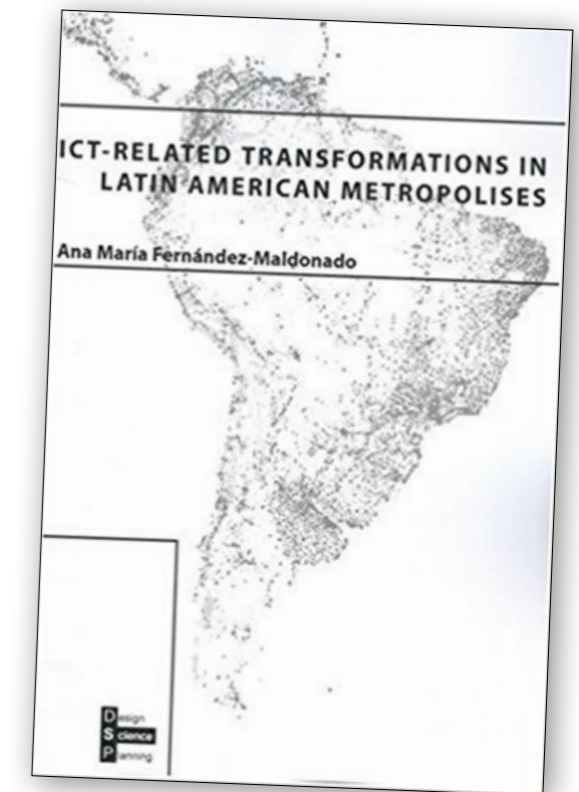

### Our third Intervention Guest was industrial design-engineer Marlies van Dullemen

(<http://www.npk.nl>)

Marlies van Dullemen is a senior designer with npk design, a renowned international design studio in Leiden, the Netherlands. Marlies focuses on exploring new technologies in a social context and has developed dozens of innovative products and services. The scope of her designs ranges from vision and scenario development, work-flow design, product architecture and new technologies right up to engineering development and realisation. She finds inspiration in collaborating with researchers and medical doctors when working on healthcare innovations such as new diagnosis and treatment systems, self-care aids, hospital beds and analytical instruments (Fig. 7). A portable Spülboy glass washer system washes clean without electricity, while saving water (Fig. 8). Marlies graduated from Delft University of Technology in 1984 and worked for General Electric before joining



Fig. 7. npk design/Marlies van Dullemen, Eden bed for Jensen, Norway, 2008 (*left*); adjustable hospital bed Plano for Novymed (*right*), 1991, at <https://npk.nl/project/jensen/>, and <https://npk.nl/projects/health-care-design/>. Photographs courtesy Jensen (Norway) and Gerrit Schreurs (the Netherlands).



Fig. 8. npk design/Marlies van Dullemen, NU@ Spülboy glass cleaner for Schicker & Schäfer, 2013, at <https://npk.nl/projects>. Photograph courtesy npk design, Leiden, the Netherlands.

the team of npk design. Her work with the npk team has been acknowledged internationally and has won numerous design awards. At the conference Marlies told us about the long and meticulous process of designing and collaborating, striving to meet the demands of clients and dreams of future users. For her and for npk, any design process is a matter of team work and exchange of ideas and thoughts, again and again. She values conversations with users to understand their considerations, which enables for translation towards new purposes of a design.<sup>2</sup> Designs may take several years to be fully realized, and many were patented. Some designs, such as a LifeSlide mass evacuation system for escaping from high buildings in the event of a calamity, were not realized

<sup>2</sup> See <https://vimeo.com> > npk design > Videos, accessed 5 October 2017.



Fig. 9. npk design / Marlies van Dullemen, LifeSlide mass evacuation system, 2007. Photograph courtesy npk design, Leiden, the Netherlands.

up to now (Fig. 9). The design of this mass evacuation system is a rescue arrangement to rapidly descent from the highest buildings to ground level.<sup>3</sup>

It is clear that women in the design-engineering profession are still a minority. Being in contact with mostly male and some female clients, Marlies finds that this is not a hindrance. She told us that she enjoys coaching young design-engineers and interns who come to work at the studio to build working relationships that value women design-engineers in this predominantly male field.

The presentation and professional activities of Marlies van Dullemen focused the attention of the conference on women as industrial design-engineers. They are a professional group that seems to have been neglected in research, which favours architects and architectural engineers. Unfortunately, and perhaps due to the focus on modernism in architecture and design, there was no conference paper on a female design-engineer of this period. The history of women engineers, however, is a rich one. For example, B. Zorina Khan investigated the women's contribution to technology by analyzing patterns of patenting and commerce between 1790 and 1895, using 4196 patents filed by women in the USA. The formal procedure for filing a patent allowed anyone to do so regardless

<sup>3</sup> Patent number: 8561759 February 27, 2008, Patented October 22, 2013. Assignee: Rapid Vertical Egress System Holding B.V. Inventors: Nicholas Paul Monks, Marlies Van Dullemen, Ingmar Christiaan Maurice, Marte Jeane Den Hollander. At <https://patents.justia.com/inventor/marlies-van-dullemen>, accessed 5 October, 2017.



Fig. 10. Romanian stamp with a portrait of Josephine Cochrane, inventor of a dish-washing machine, 2013. Web, accessed 20 September, 2015.

of gender or race if they could afford the costs. Women were, of course, a minority: they filed less than 1% of the patents but the number of their patents grew significantly after 1876.<sup>4</sup> Deborah Jaffé discussed women who patented their inventions between 1637 and 1914 in her *Ingenious Women from Tincture of Saffron to Flying Machines* (2003).<sup>5</sup> The nineteenth century in particular had many women-inventors. An example is Josephine Cochrane (1839–1913) who invented a dish-washing machine as early as 1886. On the recent centenary of her death in 2013, she was honoured with a postage stamp issued by her native country, Romania (Fig. 10). After feminist reformer Charlotte Smith argued for the recording of women patentees, the first official list of patents by women inventors in the USA was published in 1888 by the United States Patent Office.<sup>6</sup> Closer to the modernist period in architecture and design after 1918 is the invention by Mary Anderson in 1903: an automatic 'window cleaning device' of a swinging arm with rubber blade for motorised trams. It was to be universally applied to cars. Another inventor was Amélie Auguste Melitta Bentz from Leipzig, Germany, who patented a coffee filter with a paper disc in Berlin in 1908 as the *Gebrauchsmuster*, thereby laying the foundations of a company that still exists today (Fig. 11).<sup>7</sup> The range of inventions is diverse: shortly before the outbreak of World War I, Kate Jenkins from Sydney, Australia, invented a life jacket made from inflatable cork blocks, Italian physician and educator Maria Montessori held a number of patents for teaching equipment, and in 1914 Dora Lunn from London patented her lightweight Ravenscourt Potter's Wheel.<sup>8</sup>



Fig. 11. Coffee filter device designed by Melitta Bentz, patented in 1908. Web, accessed 24 September, 2017.

- 4 B. Zorina Khan, 'Not for Ornament': Patenting Activity by Nineteenth-Century Women Inventors', *Journal of Interdisciplinary History* vol. 31, number 2 (Autumn 2000), pp. 159-195, here p. 164.
- 5 More references in Eric S. Hintz, 'Counting Women Inventors', posted on 21 March 2017, at <http://invention.si.edu/counting-women-inventors>, accessed 20 September 2017.
- 6 Hintz, 'Counting Women Inventors'.
- 7 See the video 'Frische und Geschmack', by Barbara Sichtermann and Ingo Rose at <https://youtu.be/eczLJMyxHgl>, accessed 20 September 2017.
- 8 Deborah Jaffé, *Ingenious Women from Tincture of Saffron to Flying Machines*, Stroud: Sutton Publishing, 2003, pp. 49–50, 75, 101.

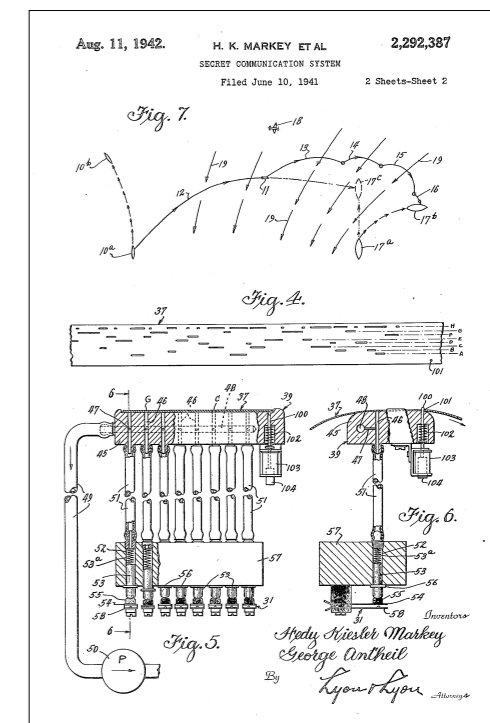

Fig. 12. Patent drawing #2 for the application of Serial No. 397,412, for a wireless 'Secret Communications System' by inventors Hedy Kiesler Markey and George Antheil, June 10, 1941, at <https://patentimages.storage.googleapis.com/pages/US2292387-1.png>, accessed 29 September 2017.

All these women were true modernists in their contribution of ingenuity and inventiveness to the field of technology. Facilitated by the internet, announcements and patent registrations document more women inventors after 1918, for example at <http://www.women-inventors.com/Women-Inventors.asp>. An intriguing patent is the one filed in 1941 by Austrian-born actress Hedy Lamarr (b. Hedwig Eva Maria Kiesler) and co-inventor George Antheil. It was for a wireless Secret Communications System 'to provide a method of secret communication which is relatively simple and reliable in operation, but at the same time is difficult to discover or decipher' (Fig. 12). The system manipulated radio frequencies at irregular intervals between transmission and reception to prevent classified messages from being intercepted by enemy personnel.<sup>9</sup> Equally interesting are achievements after 1945, such as those for new materials. In the 1980s Sally Fox from the USA refined cotton seeds through the breeding of brown and green cotton to finally produce naturally colored cotton; more cotton patents by her followed, such as for a naturally flame resistant cotton fiber in 1994.<sup>10</sup> A particular relevant invention in relation to architecture was patented by sculptor Patricia Billings of Kansas City, Missouri. She derived a new indestructible, fire-proof and non-toxic building material from plaster. This was called Geobond® and patented in 1997 (Fig. 13).

- 9 Joyce Bedi, 'A Movie Star, Some Player Pianos, and Torpedoes', posted 12 November 2015 at <http://invention.si.edu/movie-star-some-player-pianos-and-torpedoes>, accessed 6 October 2017.
- 10 At <http://www.google.com/patents/US5496623>, and <http://www.inventricity.com/sally-fox-inventor>, both accessed 9 October 2017.

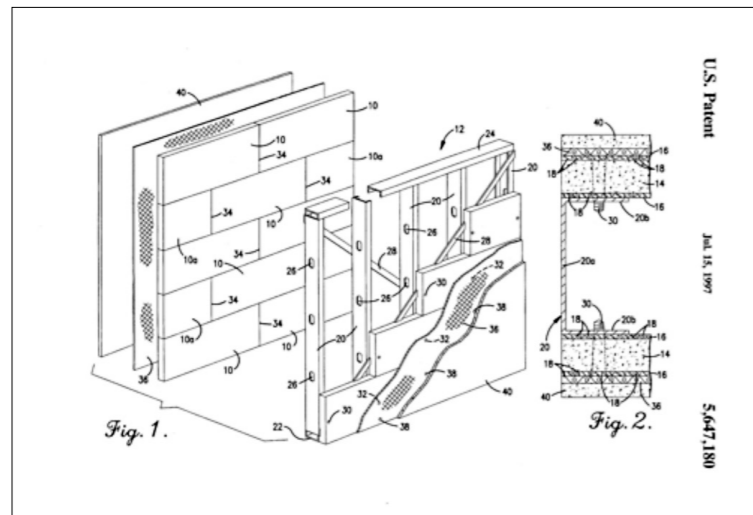

Fig. 13. Patent drawing for the application US 08/523,651, for a fire resistant building panel that can be used to construct load bearing walls and other structural members in various types of buildings, by Patricia Billings and Susan Michalski, Jul 15, 1997, at <https://patentimages.storage.googleapis.com/pages/US2292387-1.png>, accessed 29 September 2017.



Fig. 14. Joke Vos Architecten, Amsterdam, the Netherlands. Photograph courtesy Joke Vos Architecten.

#### Our fourth Intervention Guest was architect Joke Vos

([mail@jokevos.nl](mailto:mail@jokevos.nl); <http://www.jokevos>)

Joke Vos studied architecture at the Delft University of Technology. She worked in several Dutch architectural firms – amongst them Wytze Patijn and De Zwarte Hond – before starting her own practice in Rotterdam in 2003. Since 2013 her office Joke Vos Architecten (Fig. 14) has been based in Amsterdam. Joke Vos has long-standing experience in housing design and in small-scale urban design. Striking examples of her work in house design are the ‘Periscope Houses’ and ‘Het Mooie Plan’ (Beautiful Plan) in Rotterdam, and ‘In the Park’ in Etten Leur. In the last of these, art panels were integrated into the façades of 125 houses (Fig. 15). Her design for a data centre for TUd won the Dutch Concrete Award. Currently under construction is The View in Rotterdam, a mixed use development (Fig. 16).

Joke’s work is true to the modernist heritage that is still much favoured for Dutch architecture. The rectangular shapes and volumes are indebted to functionalist modernism but she also applies bricks as ‘vernacular’ material. All of her designs meet today’s demands regarding ventilation, energy supplies, application of building materials and the requirements of future inhabitants; there is participation of the people for which she designs. At the conference-workshop, Joke informed the public about the design process and the importance of collaborating with all professionals in the architectural field. Today there are more women architects than ever before and they are not regarded as alien to the profession, as they were in the 1920s and 1930s. However, collaboration on an architectural project requires an attitude of equality and not one of feeling different because one happens to be a female architect. As a woman architect, Joke is aware of her position and knows



Fig. 15. Joke Vos Architecten, ‘In the Park’, Etten Leur, 2015 (design 2007). Photograph courtesy Joke Vos Architecten.



Fig. 16. Joke Vos Architecten, 'The View of Rotterdam' (design update 2017). Photograph courtesy Joke Vos Architecten.

that she must approach any project as a professional equal to men. Joke is active in organisational committees as well. She supports her profession as chairman of Architectura et Amicitia, the association for architects and artists, and as a member of the aesthetics committee of Hilversum and of the Committee for Urban Quality in Zoetermeer.





Kataložni zapis o publikaciji (CIP) pripravili v Narodni in univerzitetni knjižnici v Ljubljani

COBISS.SI-ID=292052992

<<http://cobiss6.izum.si/scripts/cobiss?command=DISPLAY&base=99999&rid=292052992&fmt=13&lan=si>>

ISBN 978-961-05-0033-9 (pdf)