

Multi-vendor Experimental Validation of an Open Source QoT Estimator for Optical Networks

*Original*

Multi-vendor Experimental Validation of an Open Source QoT Estimator for Optical Networks / Filer, Mark; Cantono, Mattia; Ferrari, Alessio; Grammel, Gert; Galimberti, Gabriele; Curri, Vittorio. - In: JOURNAL OF LIGHTWAVE TECHNOLOGY. - ISSN 0733-8724. - ELETTRONICO. - 36:15(2018), pp. 3073-3082. [10.1109/JLT.2018.2818406]

*Availability:*

This version is available at: 11583/2704376 since: 2019-03-14T12:48:16Z

*Publisher:*

IEEE

*Published*

DOI:10.1109/JLT.2018.2818406

*Terms of use:*

This article is made available under terms and conditions as specified in the corresponding bibliographic description in the repository

*Publisher copyright*

IEEE postprint/Author's Accepted Manuscript

©2018 IEEE. Personal use of this material is permitted. Permission from IEEE must be obtained for all other uses, in any current or future media, including reprinting/republishing this material for advertising or promotional purposes, creating new collecting works, for resale or lists, or reuse of any copyrighted component of this work in other works.

(Article begins on next page)

# Multi-vendor Experimental Validation of an Open Source QoT Estimator for Optical Networks

Mark Filer, *Member, IEEE, OSA*, Mattia Cantono, *Student Member, OSA*, Alessio Ferrari, *Student Member, OSA*, Gert Grammel, *Member, VDE*, Gabriele Galimberti, and Vittorio Curri, *Member, IEEE*

**Abstract**—Dramatic increase in data traffic and future diffusion of bandwidth-hungry 5G connectivity and evolving services like virtual reality and cloud will require the implementation of the open and elastic network paradigm on backbone optical networks. To support such growth, operators are aiming at lowering optical network costs by deploying multi-vendor disaggregated optical networks supporting white boxes while maintaining target performances. To make this effort successful, a vendor-agnostic assessment of optical performance is needed, and operators and vendors are working together to achieve this. In this paper, we present the vision of the Open Optical Packet Transport – Physical Simulation Environment (OOPT-PSE) Group of the Telecom Infra Project (TIP) consortium that aims at developing an open source framework for Quality-of-Transmission (QoT) assessment for design and operation of multi-vendor optical networks. We validate the PSE QoT estimator – the optical link emulator (OLE) based on the GN-model for nonlinear fiber propagation – by comparison with experimental results on the mixed-fiber test-bed network at Microsoft labs, operated in the C-band by commercial transceivers from eight different vendors, with propagation distances up to 1945 km. An excellent agreement between OLE predictions requiring milliseconds of computational time and measurements has been observed for all channels. The observed  $\pm 0.75$  dB of accuracy in OLE predictions can be further reduced by including the stimulated Raman Scattering in the GN-model and with a more accurate capability to estimate power levels and the amount of ASE noise. Further work will be also required to automate the measurement process of operational parameters from network equipment, especially optical amplifiers, to streamline the overall QoT estimation process.

**Index Terms**—TIP, Optical communication, Open Source QoT Estimation, Multi-vendor networks, GNpy

## I. INTRODUCTION

**D**ATA traffic will experience a dramatic evolution over the next several years [1], driven by 5G access, high-definition video, virtual and augmented-reality content, and the considerable growth in cloud services. Quantitatively, the worldwide overall IP traffic is projected to grow at a compound annual growth rate (CAGR) of 24%, achieving approximately 3.3 ZB by 2021 and will change the architecture of the Internet. High-definition video exchanges – 82% in 2021 – and augmented and virtual reality interactions will further

boost demand while in parallel 5G mobile networks are rolled out to open up the access bottleneck. Overall a new service mix, mobility and an increased choice of media to access the Internet are expected to increase both the average and the busy hour (the busiest 60 minute period in a day) Internet traffic by a factor of 3.2 and 4.6, respectively, in 2016-2021 [1]. Furthermore, this dramatic growth will be also driven by the cloud market, that will cause traffic increase both within a data center (intra-DC), within geographic regions hosting different DCs (inter-DC, or DCI), and between regions in long-haul and submarine connections [2].

To sustain this growth, optical transmission systems do not only need to scale up in transported bits/fiber, but also lower the cost of transmission at an accelerated pace. Fortunately, optical technology offers several opportunities to accommodate growth and cost constraints: (i) rather than using highly specialized silicon for transmission, the industry is investing into merchant silicon that can be produced in very high volume, driving down costs significantly. For this approach to be successful, highly standardized and interchangeable products are key requirements, and several efforts are currently underway to make full end-to-end vendor-diverse inter-operable coherent optical systems a reality [3], [4]. (ii) Keeping the optical grid flexible enables the balancing of modulation rates and spectral width to tune capacity and optical reach. (iii) Introducing elasticity in optical networks to control latency and throughput adapting to changing network conditions. This requires the inclusion of physical layer quality-of-transmission (QoT) in multilayer orchestration of optical networks [5].

Addressing their needs, operators started to embrace the lessons learned from DC deployments. DCs are built upon interchangeable, highly standardized node and network architectures rather than a sum of isolated solutions. Translated to optical networking, this leads to a push in exploring multi-vendor optical networks disaggregating HW and SW based focusing on interoperability. In this paradigm, the burden of responsibility for ensuring the performance of such disaggregated open optical systems falls on the operators. Consequently, operators and vendors are collaborating in defining control models that can be readily used by off-the-shelf controllers. However, node and network models are only part of the answer. To take reasonable decisions, controllers need to incorporate logic to simulate and assess optical performance. Hence, a vendor-independent optical quality estimator is required. Given its vendor-agnostic nature, such an estimator needs to be driven by consortia of operators and system suppliers. This activity has the potential to change the way optical networks

M. Filer is with Microsoft Corporation, Redmond WA, USA, e-mail: mark.filer@microsoft.com

M. Cantono, A. Ferrari, and V. Curri are with the Department of Electronics and Telecommunications, Politecnico di Torino, Italy, e-mail: vittorio.curri@polito.it.

G. Grammel is with Juniper Networks. e-mail: ggrammel@juniper.net

G. Galimberti is with Cisco Photonics, Vimercate, Italy, e-mail: ggalimbe@cisco.com

are designed and controlled. Firstly, an agreed QoT module enables operators to simplify deployment by planning for a vendor-neutral implementation rather than relying on closed source vendor planning tools. Secondly, system integrators are empowered to pick & choose optical components from various vendors thereby designing networks fulfilling high standards while keeping costs down, built in a manner that can be simulated and confirmed by a neutral performance estimation. Thirdly, system vendors will be equipped with the necessary performance benchmark for their product offering by providing a stable base for cost/performance decisions in the design. The work on a multi-vendor QoT estimator is carried out by the Physical Simulation Environment (PSE) Group [6] within the Telecom Infra Project (TIP). Founded in February 2016, TIP is an engineering-focused initiative which is operator-driven, but features collaboration across operators, suppliers, developers, integrators, and startups with the goal of disaggregating the traditional network deployment approach. Within TIP, the Open-Optical Packet-Transport Group (OOPT) works on accomplishing network-level disaggregation for optical systems and subsystems, whereby PSE working group is tasked to provide the industry with an open source QoT estimator. Results presented in this article constitute the preliminary output of the PSE group, as the QoT estimator tool will be presented and its experimental validation will be shown.

In Sec. II, we describe the general vision of OOPT within TIP, i.e., the implementation of an open source software framework able to automate routing, signaling, and recovery in a disaggregated multi-vendor network, by acquiring operation or nominal data from equipment and by estimating transmission performances, relying on a QoT estimator. In Sec. III, we present the implementation of such a QoT estimator: the optical link emulator (OLE) based on the Gaussian Noise (GN) model which provides a quick yet approximate estimation of nonlinear transmission impairments when exploiting state-of-the-art transceivers. We also briefly describe the OLE structure and constraints that drove the implementation and modeling integration. In Sec. IV, we describe the extensive validation of the OLE that has been performed by comparing the OLE predictions with experimental measurements over the mixed-fiber network test-bed at Microsoft's lab, which is comprised of commercial equipment and permits propagation distances up to 1945 km. The measurements were carried out using commercial line cards from eight different coherent source suppliers which were complemented by bulk modulated signals and spectrally-shaped ASE channels to fill the entire C-band. Results clearly demonstrate that the OLE is able to predict performance with an accuracy of  $\pm 0.75$  dB and within computational times of the order of milliseconds, depending on the exploited computing hardware. Note that comparisons are based on bit error rate (BER) measurements from line cards, converted to the corresponding required signal-to-noise ratio (SNR) through back-to-back characterizations. So, at short distances – low BER, high SNR – the estimation is more affected by uncertainty.

A key takeaway from these extensive tests is the necessity of properly estimating the linear propagation behavior, which is

mostly determined by accurate gain and noise-figure characterization of the optical amplifiers. This is because, at the optimal power (i.e., the power maximizing the generalized SNR), the nonlinear propagation impairments represent a relatively small perturbation to the performance, which is primarily determined by the ASE noise accumulation [7]. We took great care to account for this requirement in the results presented, and the OLE proved to be an adequate tool to be exploited as QoT estimator for the planning and management of disaggregated multi-vendor networks. These tests have also demonstrated the fundamental importance of being able to automatically read operation parameters for equipment, in case of signaling operation on in-service networks. Regarding nonlinear propagation modeling, a possible upgrade will be the inclusion of the generalized GN-model [8] that considers gain/loss variations with space and frequency. Such a requirement will further improve accuracy and will make the use of the OLE possible also when operating beyond the C-band only: a scenario where the Stimulated Raman Scattering (SRS) induced crosstalk may assume an important role as well as the use of distributed full Raman amplification.

## II. THE OOPT-PSE GROUP OF TELECOM INFRA PROJECT

Increasingly, optical networks are becoming more disaggregated across different network elements, including transponders, line systems, and management. We are also seeing the disaggregation of elements that reside within the same device (i.e., the hardware and software). As we disaggregate the software stack, opening up the optical system becomes key, and vendors are already converging to make this a process with minimal friction. Digital Signal Processor (DSP) vendors are aligning to interoperate and to expose abstraction layers that make it easy for Network Operating Systems (NOS) to quickly support new chips. In turn, NOS vendors are also aligning to make it easier for the network management systems to support multiple devices without having to implement different logic for each type of device.

Optical line systems are now open and networks will soon be multi-vendor by default. Transponders are also open and offer clear programmable northbound interfaces (YANG models, REST APIs, etc.) that allow software to interact with them, as opposed to humans having to point and click every time a new circuit is provisioned. This will be a key feature enabling operators to be able to do more, faster. TIP founded the OOPT project group with the vision of unbundling monolithic packet-optical network technologies in order to unlock innovation and support new, more flexible connectivity paradigms. The group's ultimate goal is to help provide better connectivity for communities all over the world as more people come online and demand more bandwidth-intensive experiences like video, virtual reality and augmented reality. The key to open up and unbundle monolithic optical solutions is the ability to accurately plan and predict the performance of optical line systems based on an accurate simulation of optical parameters. Under the OOPT umbrella, the PSE working group set out to disrupt the planning landscape by providing an open-source simulation model that can be used freely across the industry.

## Code Blocks

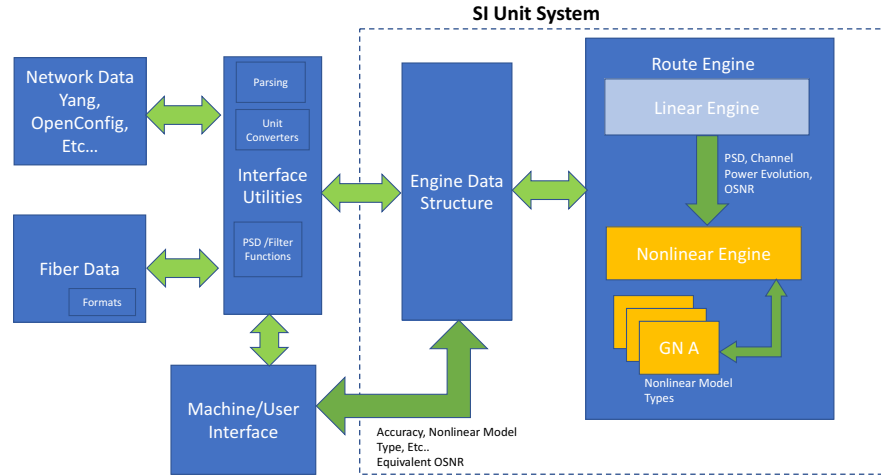

Figure 1. OOPT-PSE code architecture for an open source QoT estimation framework.

Between August and October 2017, industry members were conducting large-scale validation tests [9], [10]. In a testbed provided by Microsoft, commercial gear from a series of suppliers including Acacia, Arista, Ciena, Cisco, Coriant, Infinera, Juniper, and Nokia have been used to validate such an open source QoT estimation framework. The goal was to enable operators, system vendors and component suppliers in planning an open ecosystem with reference simulation capabilities. This will enable industrialized roll-out of large networks based on open optical line systems.

The PSE working group is developing a Python implementation of the simulation engine and has adopted a modular architectural model (see Fig. 1) that can be embedded into commercial simulation environments. The core of the Software is the SI Unit Engine. It consumes model data and estimates OSNR along a given route in the optical network. The architecture features a flexible non-linear engine to simulate nonlinear interference (NLI), allowing to balance accuracy with computing performance. This nonlinear engine is driven by the linear engine and exploiting an internal data model that allows users to utilize the complete module without code changes. Next to functionality, much thought has been put into reusability. For example, experience shows that using different units in a simulation software is prone to human error. Although converting mW into W and GHz in THz is not a challenge as such, The failure to do so leads to results that are difficult to interpret and trace back to the root cause. So the PSE team opted to use only base-SI units such as W and Hz in their simulation engine. This avoids uncertainty about the units required by the simulation model and keeps the code consistent.

Additional modules outside the core system are also foreseen in the architecture to interface and drive the SI-simulation model. As of today, data is conveniently imported from JSON files but future extensions would allow the reading of data directly from a live optical line system.

As a next step, the group is setting out to harden the simulation engine and extend it towards a larger variety of optical elements and more complex scenarios, including generalization of nonlinear propagation modeling. This will cover network planning based on end-of-life performance for a given set of optical elements as well as a real-time assessment of optical performance that can be utilized to run and troubleshoot optical networks.

### III. THE OPTICAL LINK EMULATOR

The operations of PSE simulative framework, as described in Sec. II, are based on the capability to estimate the QoT of one or more channels, or superchannels, operating lightpaths over a given network route. For backbone transport networks, we can suppose that transceivers are operating polarization-division-multiplexed multilevel modulation formats with DSP-based coherent receivers, including equalization. For the optical links, we focus on state-of-the-art amplified and dispersion-uncompensated fiber links, connecting network nodes including ROADMs, where add and drop operations on data traffic are performed. In such a transmission scenario, it is well accepted [11]–[25] to assume that transmission performances are limited by the amplified spontaneous emission (ASE) noise generated by optical amplifiers and by nonlinear propagation effects: accumulation of a Gaussian disturbance defined as NLI and generation of phase noise. State-of-the-art DSP in commercial transceivers are typically able to compensate for most of the phase noise through carrier-phase estimator (CPE) algorithms per polarization state [26]–[28]. So, for backbone networks covering medium-to-wide geographical areas, we can suppose that propagation is limited by the accumulation of two Gaussian disturbances: the ASE noise and the NLI. Additional impairments such as filtering effects introduced by ROADMs can be considered as additional equivalent penalties depending on the ratio between the channel bandwidth and the ROADMs filters and the number of traversed ROADMs (hops)

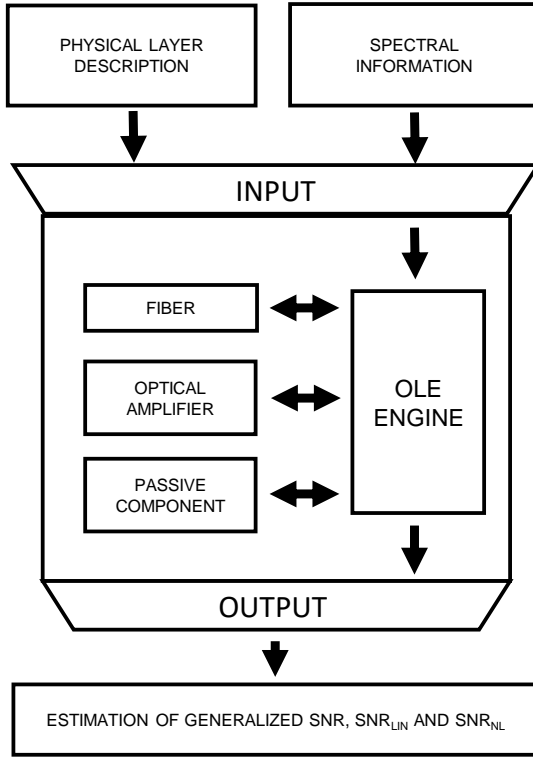

Figure 2. Block diagram for the optical link emulator operating as QoT estimator within the PSE framework.

of the route under analysis. Modeling the two major sources of impairments as Gaussian disturbances, and being the receivers *coherent*, the unique QoT parameter determining the BER for the considered transmission scenario is the generalized signal-to-noise ratio (SNR) defined as

$$\text{SNR} = L_F \frac{P_{\text{ch}}}{P_{\text{ASE}} + P_{\text{NLI}}} = L_F \left( \frac{1}{\text{SNR}_{\text{LIN}}} + \frac{1}{\text{SNR}_{\text{NL}}} \right)^{-1} \quad (1)$$

where  $P_{\text{ch}}$  is the channel power,  $P_{\text{ASE}}$  and  $P_{\text{NLI}}$  are the disturbances' power in the channel bandwidth for ASE noise and NLI, respectively.  $L_F$  is a parameter assuming values smaller or equal than one that summarizes the equivalent penalty introduced by filtering effects. In practice it is modeled as a penalty of SNR. Note that for state-of-the-art equipment, filtering effects can be typically neglected over routes with few hops [29], [30].

To properly estimate  $P_{\text{ch}}$  and  $P_{\text{ASE}}$ , the transmitted power at the beginning of the considered route must be known, and losses and amplifiers' gain and noise figure, including their variation with frequency, must be characterized. So, the evaluation of  $\text{SNR}_{\text{LIN}}$  *just* requires an accurate knowledge of equipment, which is not a trivial aspect, but it is not related to physical-model issues. For the evaluation of the NLI, several models have been proposed and validated in the technical literature [11]–[25]. The decision about which model to test within the PSE activities was driven by requirements of the entire PSE framework: (i) the model must be *local*, i.e., related individually to each network element (i.e., fiber span) generating NLI, independently of preceding and subsequent

elements; and (ii) the related computational time must be compatible with interactive operations. So, the choice fell on the GN-model with incoherent accumulation of NLI over fiber spans [20]. We implemented both the exact GN-model evaluation of NLI based on a double integral (Eq. (11) of [20]) and its analytical approximation (Eq. (120-121) of [22]). We performed several validation analyses comparing results of the two implementations with split-step simulations over wide bandwidths [31], and results clearly showed that for fiber types with chromatic dispersion roughly larger than 4 ps/nm/km, the analytical approximation ensures an excellent accuracy with a computational time compatible with real-time operations.

After these preliminary analyses and assessments, we implemented the QoT estimator in the PSE open-source framework, as a Python API called OLE [32]. The OLE structure is described by the block diagram of Fig. 2. OLE requires two families of input data: the description of the physical layer, and a set of spectral information. The former represents topological information of the route under test, i.e., the description of the link, including a detailed description of all network elements subdivided into three categories: fiber spans, amplifiers, and passive components. Spectral information requires details about the power spectral density of WDM channel and/or super-channel combs propagating over the route under analysis, including possible modifications introduced by ROADMs traversed over the route, as well as the definition of the WDM channel scheme to be used, since the power distribution among the channel affects the amount of NLI on each of them. Once inputs are set, the OLE engine runs modules related to each of the three network element categories, ordered and initialized according to the link description. Modules consider the spectra for channels, ASE noise, and NLI at their inputs, apply the frequency-dependent gain/loss and generate the output spectra. The fiber module attenuates the signal and also runs the GN-model, evaluating the amount of NLI generated by the fiber span and updating the NLI spectrum. The amplifier module amplifies the signal based on the provided gain and noise figure profiles, computes the corresponding amount of generated ASE noise, and updates the ASE noise spectrum accordingly. The passive component is a simple attenuator. Once the route under analysis has been entirely *traveled*, the generalized SNR is available for every channel. For routing or design purposes, OLE may be operated with worst-case transmission hypotheses, i.e., supposing full spectral load for each fiber link. While for signaling purposes, as for instance to automate recovery from a LP failure, the exact spectral load can be considered over each link. The computational time required by the OLE is limited to fractions of seconds for route dimensions up to thousands of network elements.

#### IV. MULTI-VENDOR EXPERIMENTAL VALIDATION

The proper implementation of the QoT estimator implemented as the OLE described in Sec. III was first verified by a simulative campaign that confirmed a conservative estimation in SNR within 0.25 dB at optimal power, as already extensively shown in the related literature. However, simulative setups inevitably represent abstractions of the real world, the

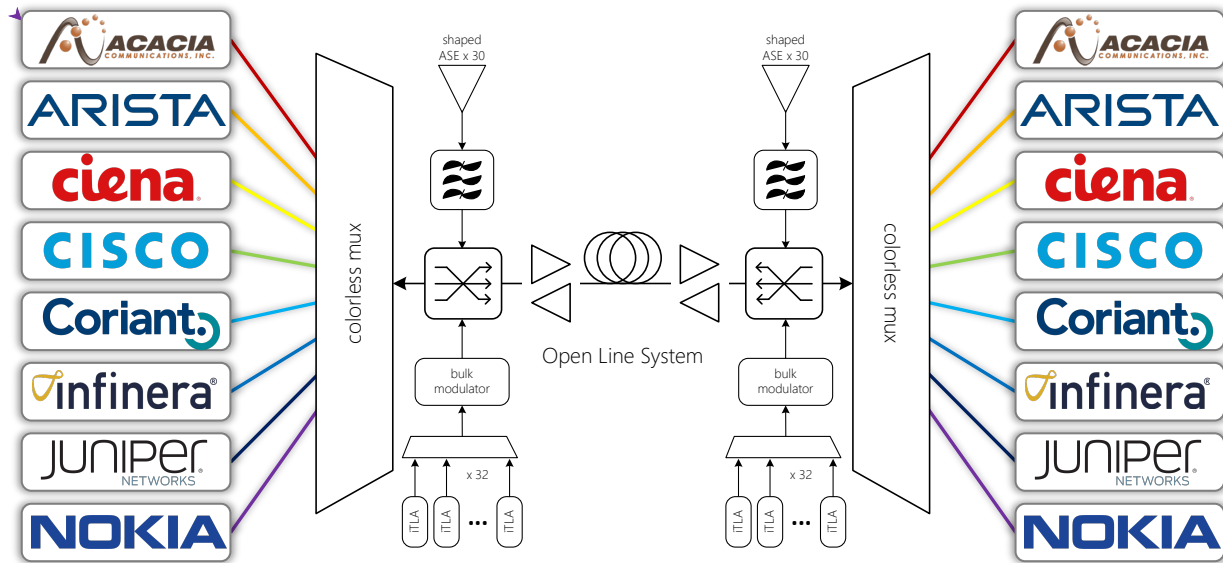

Figure 3. Simplified figure of the experimental validation setup. Transceiver solutions from 8 different vendors have been considered, together with bulk modulated channels and ASE shaped channels.

proper validation of the possible use of the OLE must be performed experimentally.

The experimental setup used for comparisons is the testbed at Microsoft lab pictorially described in Fig. 4. It consists of an open line system (OLS) connecting a mixed-fiber network route made of commercial equipment with propagation distances up to 1945 km. The OLS features a colorless, directional architecture with full SDN-enabled support for alien wavelengths. The mostly NZ-DSF fiber plant spans 1945 km bidirectionally and is roughly made up of 85 percent Corning LEAF and 15 percent Corning SSMF-28e LL. Each ROADM is equipped with a booster amplifier and a preamplifier. Eight different suppliers of coherent modems participated in the study — Acacia, Arista, Ciena, Cisco, Coriant, Infinera, Juniper, and Nokia — providing coherent sources (32 in total) spanning a variety of optical process technologies and proprietary DSP implementations (of the 32 sources, 5 unique DSP implementations are represented). All sources feature variable modulation, Nyquist pulse shaping, and symbol rates ranging from 33 to 45 GBaud depending on supplier. In the experiment, PM-8QAM was employed, and with sources featuring conventional star-8QAM constellations, multi-dimensional 8QAM implementations, and/or digital subcarrier modulation. Electro-optics employed include both silicon photonic (SiP) and indium phosphide (InP) processing technologies.

As reported in figure 3, the optical ports of the 32 discrete sources were patched into the OLS colorless multiplexers on each end, along with bulk-modulated and ASE channels. A total of 32 additional bulk-modulated sources were evenly distributed on either side of the devices under test (DUT), modulated with the same modulation format (8QAM) as the DUTs, at 34.2 GBaud and root raised cosine (RRC) Nyquist pulse shaping with 20% roll-off. The bulk modulated channels have been generated by feeding two independent Lithium-Niobate modulators with even/odd lasers with even/odd in-

dependent OTN-framed data containing PRBS payloads. No specific measures were taken to time-decorrelate even/odd signals. Another 30 shaped-ASE “channels” were added to load the remainder of the C-band. The ASE channels were shaped with a programmable WSS to emulate RRC shaped signals with 20% roll-off. In total, 94 channels spaced 50 GHz were propagated for all results reported. The normalized power spectral density (PSD) of the entire WDM comb at the input of the first span is depicted in Fig. 5.

The methodology followed during testbed measurements was as follows. The optical sources from the eight suppliers were each characterized in a back to back noise-loading setup, with BER vs OSNR captured for each device at optimal received powers (these receive power set-points were retained for the propagation measurements as well). The OSNR values from the measurements were then converted to linear SNR values by normalizing the measurement bandwidth by the symbol rate of the coherent sources, which then yields a relationship between BER performance and SNR. Next, all 94 channels were propagated over the fiber test bed, and BER was captured while sweeping optical launch powers at the full 1945 km length. The process was repeated for intermediate distances of 1540, 1165, 800, and 410 km.

Fig. 6 shows the results of the launch power sweep at each of the distances. The curves show the average performance in Q-factor across all commercial sources with error bars indicating the  $\pm$  standard deviation of each point. Despite the different DSP implementations, optimal channel launch powers were found to be within 0.5 dB of one another. BER performance at optimal launch powers, which includes both linear and nonlinear noise contributions, were captured and compared to the back to back BER vs (linear) SNR characterizations for each source. In this way, the BER values could be mapped to corresponding SNR values (which includes linear and nonlinear noise) to be compared with the output

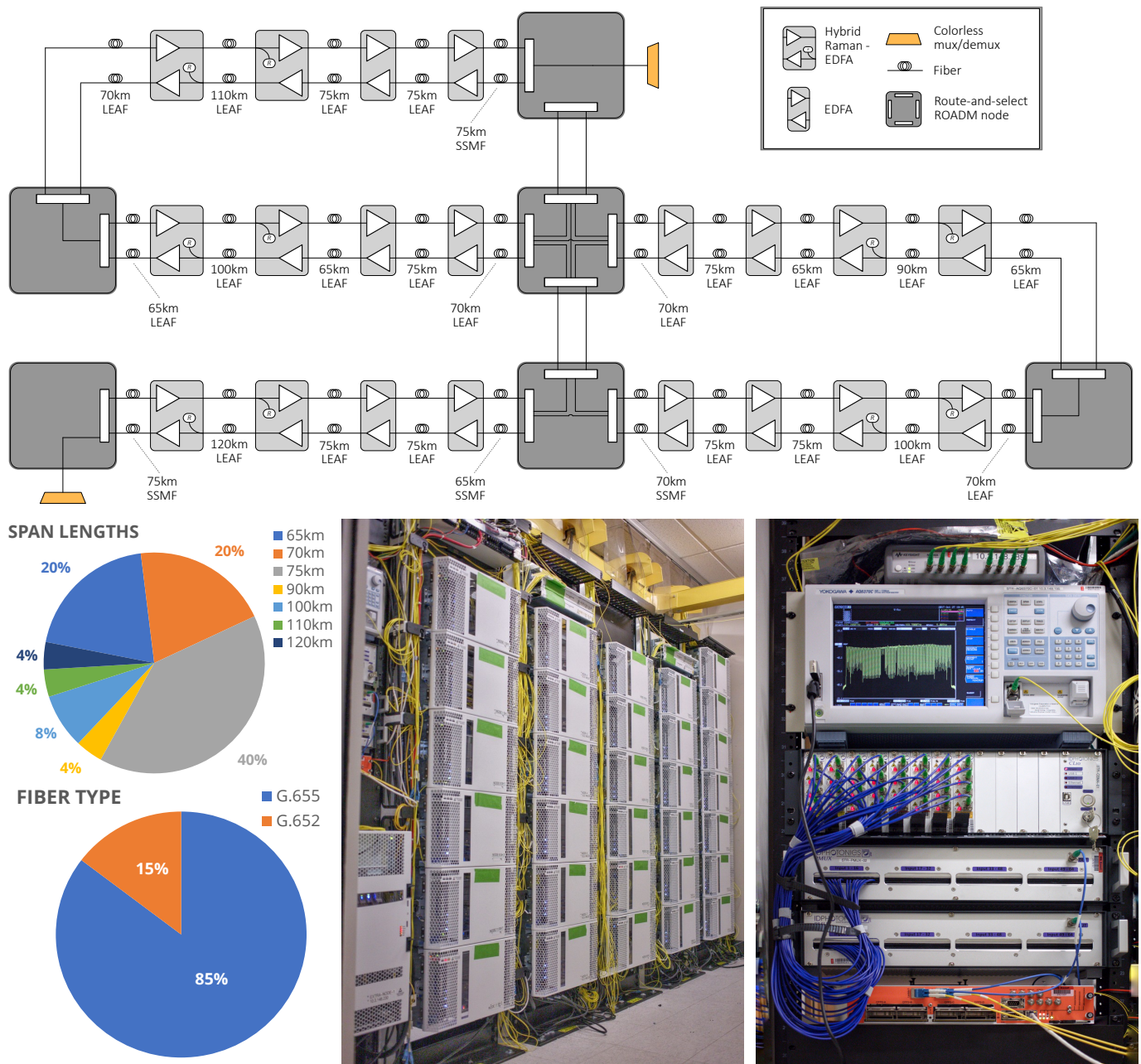

Figure 4. The Microsoft testbed used as experimental validation setup. The setup includes 2000 km of bidirectional fiber, with fiber spans made of G.652 (SSMF) and G.655 (LEAF) fibers. Span lengths are reported in the figure. Both EDFA and Hybrid Raman-EDFA amplifiers are used. Every 5 spans, a WSS is used for power equalization. Photos of the line system and of the OSA are also shown.

of the OLE software. This mapping is assumed to be valid assuming no chromatic dispersion and nonlinear penalties for the different DSP implementations.

We compare the experimentally derived generalized SNR values with the OLE estimations. OLE has been used to derive nonlinear SNR estimations using as input the channel power levels at the input of each span that have been obtained from the processing of monitoring data obtained from the OLS interfaces of the line amplifiers. Specifically, the line system reported the power level of the channel with the largest PSD computed over 12.5 GHz, thus we used this information together with spectral measurement obtained by tapping out the

signal of each line amplifier and analyzing it with an Optical Spectrum Analyzer (OSA), to obtain exact power levels of each channel, taking into account ripple and tilting effects. Furthermore, we exploited the same spectral measurements to compute linear SNR values after each amplifier by integrating the measured PSD over each channel bandwidth to obtain the channel power. Even though PSD measurements include in-band NLI noise, as NLI power is much *smaller* than channel power levels, the integration of the measured PSD yields a sufficiently accurate estimation of the channel power levels without overestimating it due to in-band NLI. Similarly, we integrated the noise levels at the side of each channel over

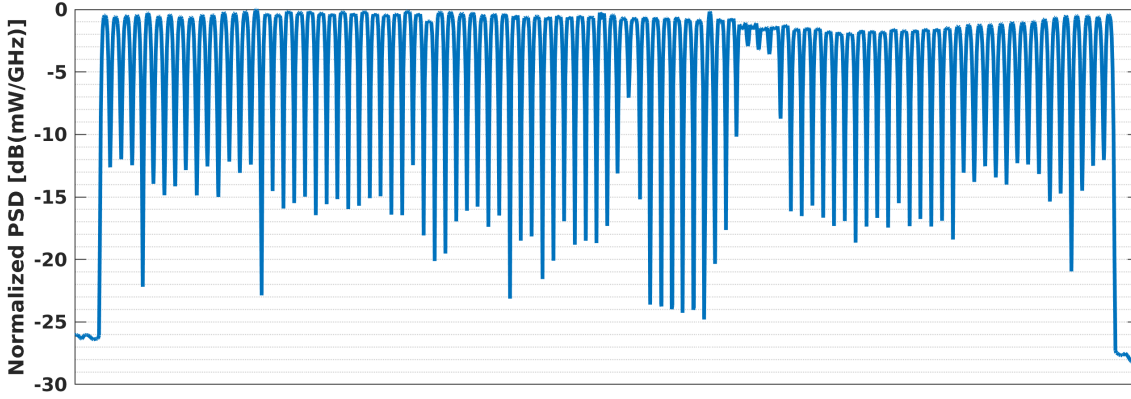

Figure 5. Normalized power spectrum of the transmitted multi-vendor channel comb.

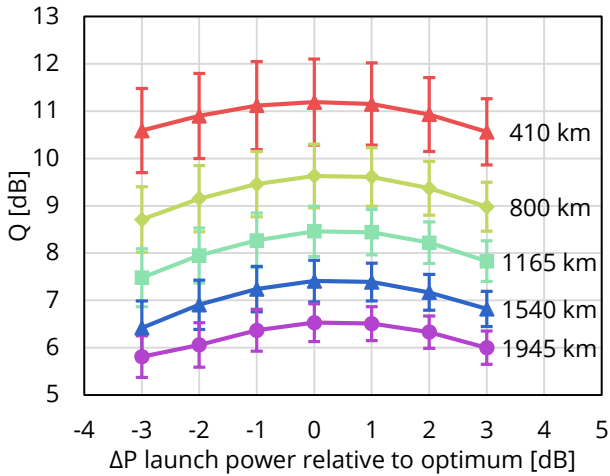
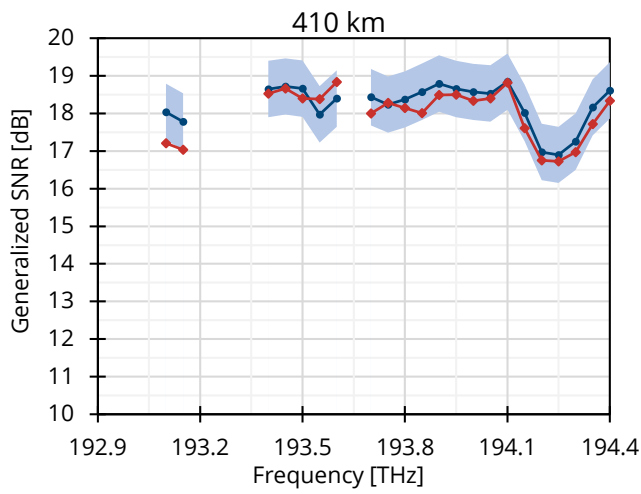

Figure 6. Power sweep reporting the Q factor respect to the launched power

a 12.5 bandwidth, and then scale the obtained value over the channel bandwidth, assuming flat ASE noise and no relevant NLI contributions outside of the channel bandwidth. To obtain the linear SNR, we computed the ratio of these two quantities. We did not directly use noise figure values provided by the OLS supplier in OLE as they yielded too conservative linear SNR results, as their noise figure values referred to end of life (EOL).

Measured and estimated SNR values are represented in Fig. 7 for the five considered distances. Fig. 7a-7e shows the SNR measurements (red diamond-marked curves) and estimations  $\pm 0.75$  dB (blue dot-marked curves) vs frequency for the 27 central frequency values of the commercial line cards used for the comparison. Fig. 7f shows the box plot for the absolute value of the estimation error vs distance. In Fig. 7a, the low frequency points are omitted as a too large an extrapolation from B2B measurement was needed to estimate their generalized SNR values. In Fig. 7e, the results at 193.55 THz and at 193.6 THz are not present since the signal degradation was too high, then the line cards were in out of service state and thus the pre-FEC BER was not available.

For all distances, a good agreement can be found between measurements and OLE-based estimations with  $\pm 0.75$  dB accuracy. It is worth to mention that these results represent also the first validation of the GN-model in a mixed-fiber scenario with commercial linecards. The oscillations in the generalized SNR are mainly due to the ripple of the amplifier gain. We overcame this problem in the prediction feeding the fiber module with the actual power profile but, for next steps, it will be important to automate this process as well as to have an accurate characterization of the amplifiers' gain and noise figure frequency profiles. Channels at the edges of WSSs media channels and high symbol rate channels show larger estimation errors due to filtering effects, preventing reliable linear SNR measurements with the previously described procedure. This is due to the fact that the noise floor measurement from OSA traces is not reliable for these channels. Some of these points are represented by the outliers in the box plots of Fig. 7f. Furthermore, as the OLE version used for this validation campaign does not include Hybrid Raman amplification and Stimulated Raman Scattering modeling for both linear and nonlinear SNR estimation [8], some inconsistency across the estimations can be expected. Additionally, the OLS used in the testbed automatically applied channel tilting of each amplifier to compensate for Raman tilting during propagation. This effect is yet again not modeled in OLE, but it has been shown to be relevant for both linear and nonlinear SNR estimations [33], [34] since it modifies the attenuation of each channel along the fiber accordingly to the PSD at the input of the fiber. These effects explain why the OLE estimations, for the majority of the channels, are not conservative with respect to SNR measurements as it is usually shown in literature and by simulations [20], [31]. It is also reasonable to assume that this effect can be caused by the fact that the bulk-modulated sources have a higher degree of correlation than independent and identically distributed sources in a real system, and that the ASE channels are more aggressive interferers than data-carrying signals. This is likely responsible for the general trend seen in Fig. 7. Lastly, the current OLE version does not include filtering penalty estimation. However, it is worth highlighting that the error distributions are consistent with OOPT-PSE goals



(a) SNR comparison after 410 km.

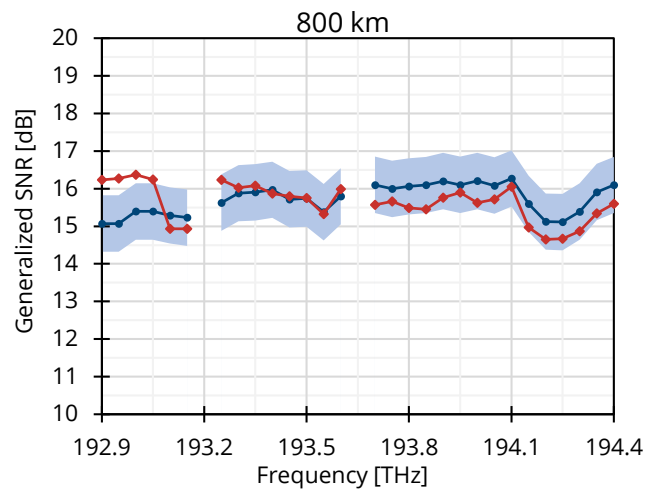

(b) SNR comparison after 800 km.

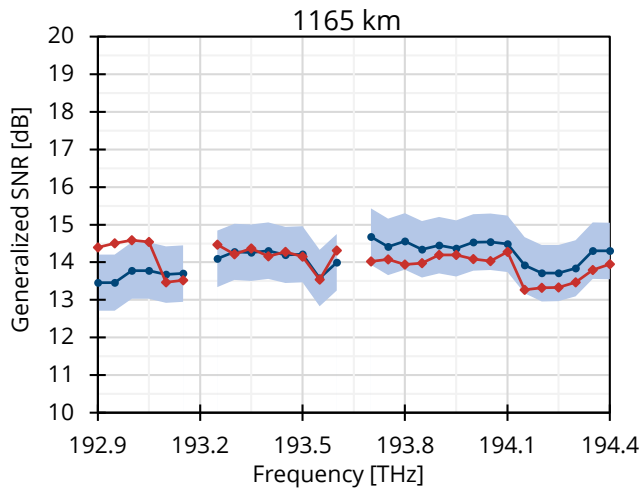

(c) SNR comparison after 1165 km.

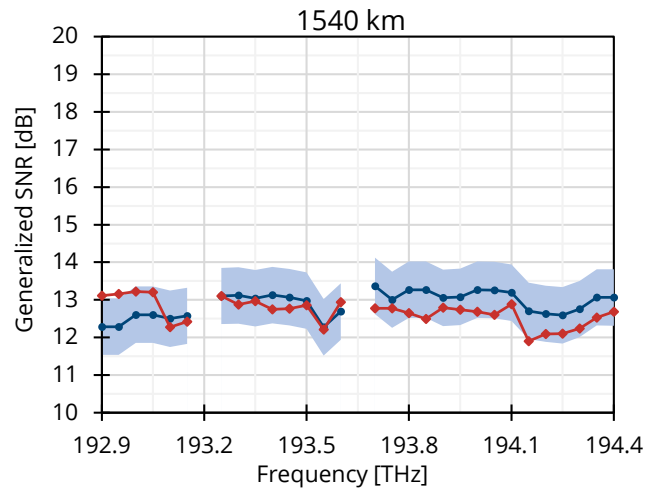

(d) SNR comparison after 1540 km.

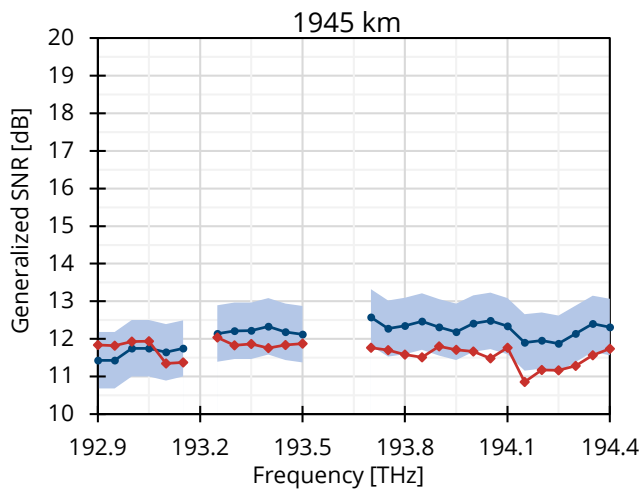

(e) SNR comparison after 1945 km.

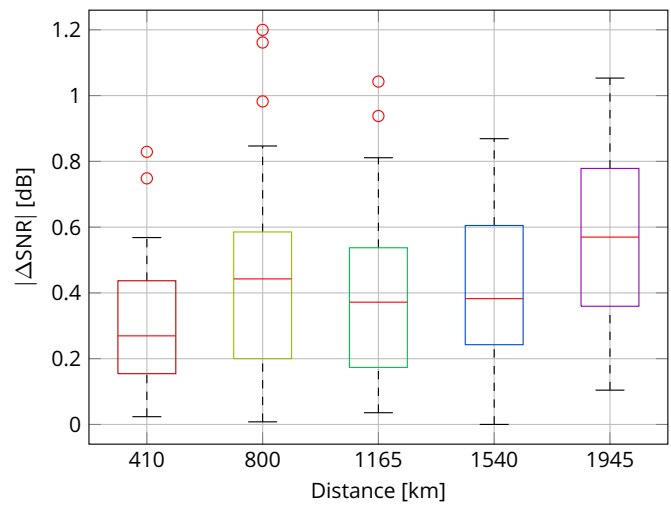

(f) Boxplot of SNR estimation error in absolute value vs distance.

Figure 7. SNR values measured from commercial linecards (red diamond-marked curves) and estimated through the OLE software (blue circle-marked curves) at different distances. A  $\pm 0.75$  dB area around OLE estimation is shown in light blue. The box plots for the absolute value of the SNR estimation error are also reported.

with respect to estimation precision, even though there is much room for improvement for the adopted algorithms. The median of the absolute value of the SNR estimation error  $\Delta\text{SNR}$  varies from 0.27 dB to 0.57 dB from 410 km to 1945 km. The mean interquartile range (IQR) across all distances is 0.36 dB. This growth in  $\Delta\text{SNR}$  median vs distance is due to the several effects that OLE is currently neglecting, causing an accumulation of errors with increasing distance. These issues represent some of the directions in which the development of OLE will move.

## V. CONCLUSIONS AND NEXT STEPS

We have presented the vision of the OOPT-PSE Group of the Telecom Infra Project consortium to develop open source code to operate multi-vendor disaggregated networks. We have shown the validation of the optical link emulator based on the GN-model that has been developed to operate as a QoT estimator for network design and control operations. OLE predictions have been compared with experimental results on the mixed-fiber test-bed network at the Microsoft labs, operated by commercial transceivers from eight vendors, plus bulk-modulated and ASE noise-shaped channels to fully populate the C-band. Measurements up to 1945 km of propagation distance always fall on the  $\pm 0.75$  dB range from the OLE predictions obtained in few milliseconds of computational time. Such a result confirms that the OLE provides accurate enough SNR estimation in a setup using a large variety of different sources and can be used to enable network operations with margins lower than 1 dB. The presented test also suggested further improvements to be considered for the next steps of the PSE group. The most critical issue emerged from this work is getting operational parameters from network equipment for planning and monitoring purposes, with special regard for spectrally defined gain and noise figure of optical amplifiers. Another improvement will be enabled by a proper estimation of the equivalent loss due to filtering effects, mostly introduced by ROADMs. Regarding nonlinear propagation modeling, better accuracy is envisioned to be achieved with the generalization of the GN-model with the inclusion of fiber gain/loss dependence with space/frequency. This will enable to properly predict performance when the exploited bandwidth exceeds the C-band, by considering the effects of SRS crosstalk and of full-Raman amplification on NLI generation.

## VI. ACKNOWLEDGEMENTS

The authors would like to thank all the members of the OOPT-PSE group of TIP for their efforts, in general to pursuing the final goal of the consortium, and in particular in giving support and suggestions to obtaining results presented in this article.

## REFERENCES

[1] Cisco, "Cisco Visual Networking Index: Forecast and Methodology, 2016–2021." [Online]. Available: <https://www.cisco.com/c/en/us/solutions/collateral/service-provider/visual-networking-index-vni/complete-white-paper-c11-481360.pdf>

[2] X. Zhao, V. Vusirikala, B. Koley, V. Kamalov, and T. Hofmeister, "The prospect of inter-data-center optical networks," *IEEE Communications Magazine*, vol. 51, no. 9, pp. 32–38, 2013.

[3] M. Filer, H. Chaouch, and X. Wu, "Toward transport ecosystem interoperability enabled by vendor-diverse coherent optical sources over an open line system," *J. Opt. Commun. Netw.*, vol. 10, no. 2, pp. A216–A224, Feb 2018. [Online]. Available: <http://jocn.osa.org/abstract.cfm?URI=jocn-10-2-A216>

[4] Gazzetabyte. The OIF's 400ZR coherent interface starts to take shape. [Online]. Available: <http://www.gazzetabyte.com/home/2017/6/22/the-oifs-400zr-coherent-interface-starts-to-take-shape.html>

[5] V. Curri, M. Cantono, and R. Gaudino, "Elastic All-Optical Networks: A New Paradigm Enabled by the Physical Layer. How to Optimize Network Performances?" *Journal of Lightwave Technology*, vol. 35, no. 6, pp. 1211–1221. [Online]. Available: <http://ieeexplore.ieee.org/document/7829312/>

[6] Telecom infra project. [Online]. Available: <https://www.telecominfraproject.com>

[7] V. Curri and A. Carena, "Merit of Raman Pumping in Uniform and Uncompensated Links Supporting NyWDM Transmission," *Journal of Lightwave Technology*, vol. 34, no. 2, pp. 554–565. [Online]. Available: <http://ieeexplore.ieee.org/document/7254112/>

[8] M. Cantono, D. Pileri, A. Ferrari, and V. Curri, "Introducing the Generalized GN-model for Nonlinear Interference Generation including space/frequency variations of loss/gain," *arXiv preprint arXiv:1710.02225*.

[9] B. Taylor, G. Goldfarb, S. Bandyopadhyay, V. Curri, and H.-J. Schmidtko, "Towards a route planning tool for open optical networks in the telecom infrastructure project," in *Optical Fiber Communication Conference/National Fiber Optic Engineers Conference 2018*, 2018.

[10] G. Grammel, V. Curri, and J. L. Auge, "Physical simulation environment of the telecommunications infrastructure project (tip)," in *Optical Fiber Communication Conference/National Fiber Optic Engineers Conference 2018*, 2018.

[11] F. Vacondio, O. Rival, C. Simonneau, E. Grellier, A. Bononi, L. Lorcy, J.-C. Antonia, and S. Bigo, "On nonlinear distortions of highly dispersive optical coherent systems," *Optics Express*, vol. 20, no. 2, p. 1022. [Online]. Available: <https://www.osapublishing.org/oe/abstract.cfm?uri=oe-20-2-1022>

[12] A. Bononi, P. Serena, N. Rossi, E. Grellier, and F. Vacondio, "Modeling nonlinearity in coherent transmissions with dominant intrachannel-four-wave-mixing," *Optics Express*, vol. 20, no. 7, p. 7777. [Online]. Available: <https://www.osapublishing.org/oe/abstract.cfm?uri=oe-20-7-7777>

[13] A. Carena, V. Curri, G. Bosco, P. Poggiolini, and F. Forghieri, "Modeling of the Impact of Nonlinear Propagation Effects in Uncompensated Optical Coherent Transmission Links," *Journal of Lightwave Technology*, vol. 30, no. 10, pp. 1524–1539. [Online]. Available: <http://ieeexplore.ieee.org/document/6158564/>

[14] A. Mecozzi and R.-J. Essiambre, "Nonlinear Shannon Limit in Pseudolinear Coherent Systems," *Journal of Lightwave Technology*, vol. 30, no. 12, pp. 2011–2024. [Online]. Available: <http://ieeexplore.ieee.org/document/6175093/>

[15] M. Secondini and E. Forestieri, "Analytical Fiber-Optic Channel Model in the Presence of Cross-Phase Modulation," *IEEE Photonics Technology Letters*, vol. 24, no. 22, pp. 2016–2019. [Online]. Available: <http://ieeexplore.ieee.org/document/6297443/>

[16] P. Johannisson and M. Karlsson, "Perturbation Analysis of Nonlinear Propagation in a Strongly Dispersive Optical Communication System," *Journal of Lightwave Technology*, vol. 31, no. 8, pp. 1273–1282. [Online]. Available: <http://ieeexplore.ieee.org/document/6459512/>

[17] R. Dar, M. Feder, A. Mecozzi, and M. Shtaif, "Properties of nonlinear noise in long, dispersion-uncompensated fiber links," *Optics Express*, vol. 21, no. 22, p. 25685. [Online]. Available: <https://www.osapublishing.org/oe/abstract.cfm?uri=oe-21-22-25685>

[18] P. Serena and A. Bononi, "An Alternative Approach to the Gaussian Noise Model and its System Implications," *Journal of Lightwave Technology*, vol. 31, no. 22, pp. 3489–3499. [Online]. Available: <http://ieeexplore.ieee.org/document/6621015/>

[19] M. Secondini, E. Forestieri, and G. Prati, "Achievable Information Rate in Nonlinear WDM Fiber-Optic Systems With Arbitrary Modulation Formats and Dispersion Maps," *Journal of Lightwave Technology*, vol. 31, no. 23, pp. 3839–3852. [Online]. Available: <http://ieeexplore.ieee.org/document/6655896/>

[20] P. Poggiolini, G. Bosco, A. Carena, V. Curri, Y. Jiang, and F. Forghieri, "The GN-Model of Fiber Non-Linear Propagation and its Applications,"

- Journal of Lightwave Technology*, vol. 32, no. 4, pp. 694–721. [Online]. Available: <http://ieeexplore.ieee.org/document/6685826/>
- [21] R. Dar, M. Feder, A. Mecozzi, and M. Shtaif, “Accumulation of nonlinear interference noise in fiber-optic systems,” *Optics Express*, vol. 22, no. 12, p. 14199. [Online]. Available: <https://www.osapublishing.org/oe/abstract.cfm?uri=oe-22-12-14199>
- [22] P. Poggiolini, A. Carena, V. Curri, G. Bosco, and F. Forghieri, “Analytical Modeling of Nonlinear Propagation in Uncompensated Optical Transmission Links,” *IEEE Photonics Technology Letters*, vol. 23, no. 11, pp. 742–744. [Online]. Available: <http://ieeexplore.ieee.org/document/5735190/>
- [23] S. J. Savory, “Approximations for the Nonlinear Self-Channel Interference of Channels With Rectangular Spectra,” *IEEE Photonics Technology Letters*, vol. 25, no. 10, pp. 961–964. [Online]. Available: <http://ieeexplore.ieee.org/document/6491442/>
- [24] A. Bononi, O. Beucher, and P. Serena, “Single- and cross-channel nonlinear interference in the Gaussian Noise model with rectangular spectra,” *Optics Express*, vol. 21, no. 26, p. 32254. [Online]. Available: <https://www.osapublishing.org/oe/abstract.cfm?uri=oe-21-26-32254>
- [25] P. Johannisson and E. Agrell, “Modeling of Nonlinear Signal Distortion in Fiber-Optic Networks,” *Journal of Lightwave Technology*, vol. 32, no. 23, pp. 4544–4552. [Online]. Available: <http://ieeexplore.ieee.org/document/6915838/>
- [26] P. Poggiolini and Y. Jiang, “Recent Advances in the Modeling of the Impact of Nonlinear Fiber Propagation Effects on Uncompensated Coherent Transmission Systems,” *Journal of Lightwave Technology*, vol. 35, no. 3, pp. 458–480. [Online]. Available: <http://ieeexplore.ieee.org/document/7577671/>
- [27] C. Schmidt-Langhorst, R. Elschner, F. Frey, R. Emmerich, and C. Schubert, “Experimental analysis of nonlinear interference noise in heterogeneous flex-grid wdm transmission,” in *2015 European Conference on Optical Communication (ECOC)*, Sept 2015, pp. 1–3.
- [28] T. Fehenberger, M. Mazur, T. A. Eriksson, M. Karlsson, and N. Hanik, “Experimental analysis of correlations in the nonlinear phase noise in optical fiber systems,” in *ECOC 2016; 42nd European Conference on Optical Communication*, Sept 2016, pp. 1–3.
- [29] T. Rahman, A. Napoli, D. Rafique, B. Spinnler, M. Kuschnerov, I. Lobato, B. Clouet, M. Bohn, C. Okonkwo, and H. de Waardt, “On the Mitigation of Optical Filtering Penalties Originating From ROADM Cascade,” *IEEE Photonics Technology Letters*, vol. 26, no. 2, pp. 154–157. [Online]. Available: <http://ieeexplore.ieee.org/document/6662421/>
- [30] T. Foggi, G. Colavolpe, A. Bononi, and P. Serena, “Overcoming filtering penalties in flexi-grid long-haul optical systems.” *IEEE*, pp. 5168–5173. [Online]. Available: <http://ieeexplore.ieee.org/document/7249144/>
- [31] D. Piloni, M. Cantono, A. Carena, and V. Curri, “FFSS: The fast fiber simulator software.” *IEEE*, pp. 1–4. [Online]. Available: <http://ieeexplore.ieee.org/document/8025002/>
- [32] OOPT\_PSE. GNpy: Optical Route Planning Based on Gaussian Noise Model. [Online]. Available: <https://github.com/Telecominfraproject/gnpy>
- [33] M. Cantono, J. L. Auge, and V. Curri, “Modelling the impact of SRS on NLI generation in commercial equipment: an experimental investigation,” in *Optical Fiber Communication Conference/National Fiber Optic Engineers Conference 2018*, 2018.
- [34] M. Cantono, D. Piloni, A. Ferrari, C. Catanese, J. Thouras, J. L. Auge, and V. Curri, “On the Interplay of Nonlinear Interference Generation with Stimulated Raman Scattering for QoT Estimation,” *Journal of Lightwave Technology*, vol. PP, no. 99, pp. 1–1, 2018.