

Preliminary study of the hybrid solar DEC "nAC wall" system integration in building façades in urban context

Original

Preliminary study of the hybrid solar DEC "nAC wall" system integration in building façades in urban context / Simonetti, Marco; Gentile, Vincenzo; Chiesa, Giacomo; Nigra, Marianna. - In: ENERGY PROCEDIA. - ISSN 1876-6102. - ELETTRONICO. - 134:134(2017), pp. 588-597. [10.1016/j.egypro.2017.09.570]

Availability:

This version is available at: 11583/2701704 since: 2018-02-27T08:08:58Z

Publisher:

Elsevier Ltd

Published

DOI:10.1016/j.egypro.2017.09.570

Terms of use:

This article is made available under terms and conditions as specified in the corresponding bibliographic description in the repository

Publisher copyright

(Article begins on next page)



9th International Conference on Sustainability in Energy and Buildings, SEB-17, 5-7 July 2017,
Chania, Crete, Greece

Preliminary study of the hybrid solar DEC “NAC wall” system integration in building façades in urban context

Marco Simonetti^{a*}, Vincenzo Gentile^a, Giacomo Chiesa^b, Marianna Nigra^c

^a Dept. of Energy, Politecnico di Torino, c.so Duca degli Abruzzi 24, 10129 Torino, Italy ^b Dept. of Architecture and Design, viale Mattioli 39,
10125 Torino, Italy ^c Dept. of Management and Production Engineering, c.so Duca degli Abruzzi 24, 10129 Torino, Italy

Abstract

A new concept of hybrid/natural air conditioning system, “NAC (Natural Air Conditioning) wall”, with a high level of architectural integration is presented. NAC wall concept is that of a solar DEC (Desiccant Evaporative Cooling) open cycle with very low pressure drops, thus drastically reducing, or even avoiding, the electricity consumption for driving fans. The supply air is dehumidified by an adsorption bed and is cooled indirectly by an evaporative cooler, through a low pressure drop heat exchanger. Adsorption bed is a finned coil heat exchanger coated with a SAPO-34 zeolite layer realizing both heat and mass transfer in a unique component. The assembling of NAC wall components is analysed in order to optimize architectural integration and performances. Experimental data carried out in different operation mode offered promising optimization suggestions to increase the specific cooling power for a better building integration. The integration at a building level would represent an architectural innovation, and the NAC wall production would not impact the supply chain with disruptive changes.

© 2017 The Authors. Published by Elsevier Ltd.
Peer-review under responsibility of KES International.

Keywords: Solar cooling, Building integration, Barriers to innovation

* Corresponding author. Tel.: +39-011-090-4544; fax: +39-011-090-4499.
E-mail address: marco.simonetti@polito.it

1. Introduction

This paper reports the current development of the NAC wall system, by resuming the main measured performance, and focusing on the integration with building façades.

The NAC wall project aims to integrate a solar DEC system in building facades with a vertical disposition of a dehumidification module and the evaporative module. The NAC wall configuration can exploit natural buoyancy of air, as well as all the components have been optimized for low air velocity operative conditions, which implies very low pressure drops.

Open desiccant cooling cycles, thermally driven by solar collectors, have the potential to become likely low energy cooling systems [1]. Moreover, Henning et al. [2] stated that these systems allow saving up to 50% of primary energy, compared with conventional vapor compression technologies, involving low operating costs and moderate environmental impact. However, dehumidification phase and control system need to be optimized, in order to improve the efficiency of these processes [3].

In the past years, many researchers studied energy and economic benefits of the use of desiccant cooling cycle, based on dehumidification wheel with silica gel coating [4] [5] [6].

However, these systems are very difficult to integrate in a building due to the large size of the dehumidification component.

The goal of the project is to develop an effective, affordable and easy-to-integrate cooling system, consuming the lowest possible amount of electricity [7].

In the first section are reported last experimental results of dehumidification performance of desiccant heat exchanger in hybrid ventilation. Further on a discussion of the integration possibility of the NAC wall in the building façade have been carried out by authors.

2. NAC wall adsorption unit

The NAC wall includes a dehumidification component based on an air/water heat exchanger. This is realized by applying a coating of SAPO34 zeolite material on a coil, Figure 1,2. With this configuration, simultaneous heat and mass transfer happens in the dehumidification component, taking advantage both in desorption and in adsorption phase. The improvement on mass transport phenomena increase the total cooling power of a DEC system, and a reduction of global dimensions can be achieved. The reduction of system encumbrance is an important key point to achieve a better integration of DEC systems in buildings and façade. The finned coil has been sized in order to reduce as much as possible the air side pressure drops, and, consequently, the electric consumptions. In Table(1) information about coil heat exchanger are reported.

Table 1 . Finned heat exchange characteristics

Pipe specs	Copper $\phi 16 \text{ mm} \times 0.35 \text{ mm}$
Fin specs	Aluminum 0.23 mm
Fin dimensions	480x150 mm
Fin spacing	8 mm
Surface	6.4 m ²

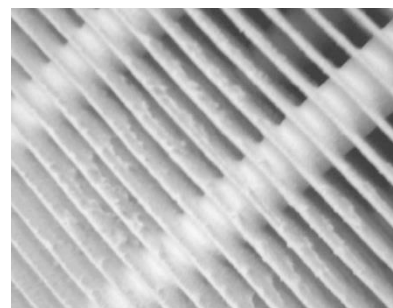

Figure 1.Coated Finned coil for heat and mass transfer Figure 2 Zoom of the SAPO 34 coating

In order to exploit a solid adsorption bed without interruption it is necessary to use a batch configuration. Two dehumidification components work in parallel, switching between adsorption and regeneration phase, as shown in Figure (3). When one adsorption bed is in dehumidification mode, it adsorbs water vapor from the outdoor air flow; this transformation follows the line A-B in the psychrometric chart of Figure(4). Heat of adsorption increases air temperature up to 50-60 °C. In a DEC system, after the dehumidification stage, air is cooled down by an Indirect

Evaporative Cooler (IEC). Drops evaporation realizes a latent heat exchange on secondary flow, cooling the primary air and not increasing its moisture content (transformation B-E). The secondary airstream (A-D) is discharged directly to the external environment, while the primary airflow is supplied to the room. Typical summer outdoor conditions are in the range 30-35 °C and 15-18 g/kg. This system can handle fresh supply air, cooling and dehumidifying it at 23-25 °C and 8-10 g/kg.

The adsorbent mean stores the moisture extracted from the air, until its saturation point is reached. The saturation is a function of vapor pressure, thus, indirectly, of air temperature and humidity. When saturation is reached, the adsorption phase finishes, and an air damper shifts the air treatment to the parallel dehumidifier. The regeneration of the saturated material is done leveraging a hot water flux through the coil. The cycle is repeated, providing continuity for the air treatment process.

The SAPO34, a sorbent material with high water adsorption ability belonging to the zeolite family, is used. SAPO (silico-aluminophosphate) zeolites are very attractive for application in solar-driven adsorption air dehumidification systems, due to the low regeneration temperature (<100°C) and optimal shape of the water adsorption equilibrium curve. Despite having achieved good results in the regeneration phase, a full natural buoyancy operation showed low performance in terms of cooling power [7]. Hence, a hybrid airflow regime has been tested in the current stage of the research.

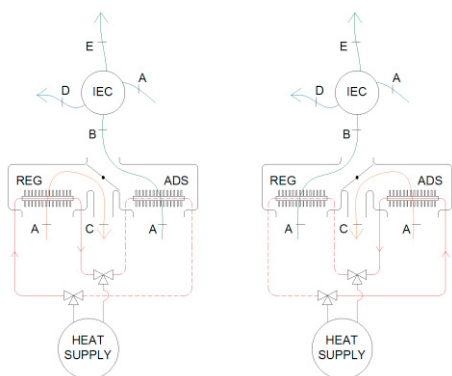

Figure 3 Scheme with two parallel dehumidifier (current)

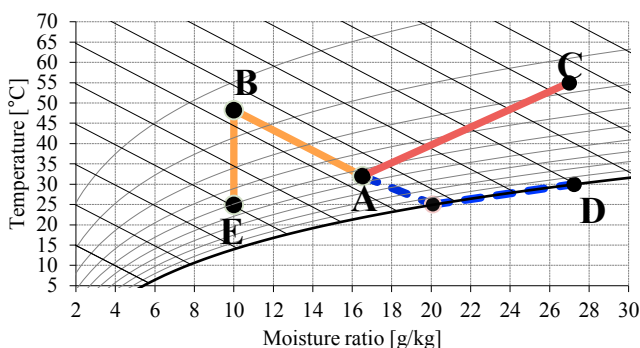

Figure 4. Air transformation on the psychrometric with isenthalpic adsorption (current)

3. Current prototype performances

In the HNAC (Hybrid Natural Air Conditioning) labs of DENERG department of Politecnico di Torino, a NAC wall prototype has been tested both in full natural buoyancy and hybrid ventilation regimes.

An experiment has been carried out to evaluate performances of dehumidification component in typical summer conditions [8]. The diagram of Figure 7 shows the average air dehumidification effect, during adsorption, after 15, 30 and 45 minutes, as well as the thermal energy required for regeneration. The results show some bias, mainly due to an imperfect control of the inlet air conditions, in terms of temperature and humidity. In fact, a low variation in term of humidity can influence significantly the performance.

In Figure 8 measured pressure drops are shown as a function of air flow rates. The highest measured value is 12 Pa at around 700 m³/h, corresponding to a power of the fan of around 6 W.

An estimation of the Coefficient Of Performance (COP) of the dehumidifier is depicted in Figure 9, using this formula:

$$COP_{el} = \frac{E_{total\ cooling}}{El_{ventilation} + El_{water\ circulation}}$$

where:

- $E_{total\ cooling}$ is the cooling energy, derived as integration on time of total cooling power produced by adsorption component [J];
- $El_{ventilation}$ is the electrical consumption of fan [J];

- $E_{\text{water circulation}}$ is the electrical consumption of water pumps [J].

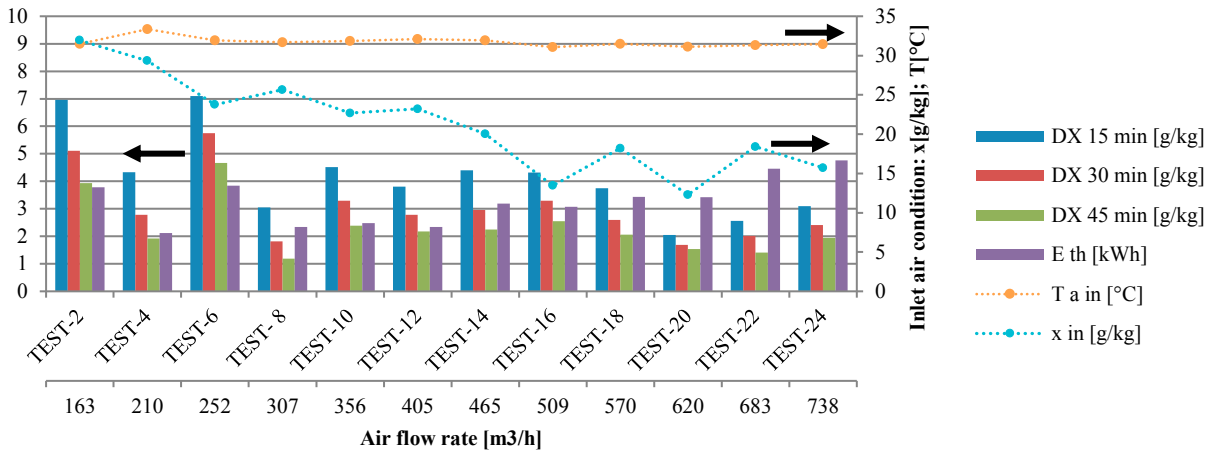

Figure 5. Average dehumidification (values on left axes) of tests in mechanical ventilation after 15, 30 and 45 min of adsorption and the total thermal energy for regeneration (values on left axes), against air inlet condition (values on right axes).

Total cooling power, in the same diagram of Figure 9, is defined as the net balance between the sensible term (positive due to the increase of temperature) and the latent term (negative due to the dehumidification) during the adsorption phase. Figure 9 clearly underline the effect of sensible load. As showed in the graph, the sensible term is relevant during the first 10 minutes of the process in which is concentrated the higher dehumidification rate, becoming negligible after this period.

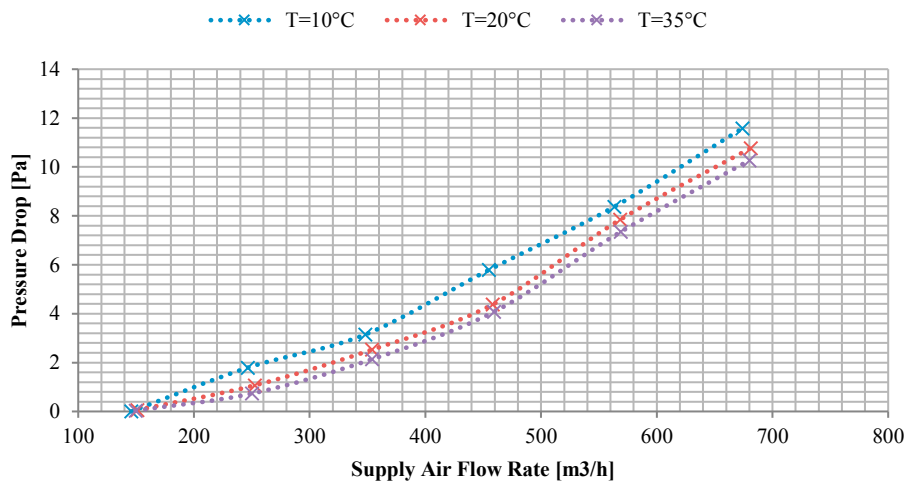

Figure 6. Pressure drops characteristic of Zeolite adsorber.

The latent term follows the behavior of the dehumidification rate, which becomes stationary after the first transient. The electrical COP of the transformation can be defined in three regions:

- The first goes from the start of adsorption to around 5 minutes, in which is negative because the sensible term is higher than the latent term, so the produced cooling power by the system is wasted by the sensible term;
- The second goes from 5 to 15 minutes, in which COP increase up to a maximum value of 25;

- The third part in which the COP has a decreasing slope due to reduction of dehumidification rate for the saturation of the adsorbent mean.

This evidence suggests that - despite good values of COP reached in the middle part of the experiment - the first part, in which the maximum dehumidification rate happens, requires further optimization to avoid the waste of useful cooling power. Further tests will be carried out at HNAC labs using the cooled adsorption approach. A cold water circulation through the pipes of the dehumidifier can subtract the heat of adsorption and the residual heat of regeneration. Then it is rejected to the environment with a cooling tower, exploiting the outlet air coming from the evaporative cooling stage of the DEC system.

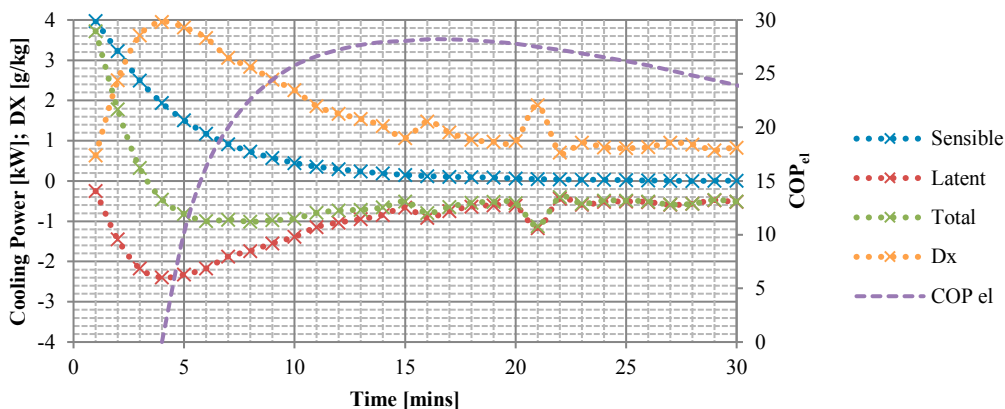

Figure 7. Sensible and latent power, dehumidification and COP, as functions of time, during the dehumidification with finned coil heat exchanger coated with SAPO 34, in the hybrid ventilation test 22.

4. Architectural integration of the façade module

In this section, the NAC wall system is analyzed in order to consider its possible architectural integration. Firstly, a performance-driven analysis is developed to define principal needs and requirements of each technological element. Secondly, the input/output flows related to the activities performed by each technical element are analyzed, together with the naturally inducted direction of each airflow. These two steps allow to define the technological background toward the architectural integration of the system. Finally, possible integration sketches are reported.

4.1. Functional, operational and environmental requirements of NAC-wall technical elements

The four technical elements constituting a NAC-wall system are here analyzed. Table (2) defines the main functional, operational and environmental requirements of each technical element toward architectural integration.

Table 2. Principal requirements toward NAC wall architectural integration.

Technical element	Environmental requirements	Functional requirements	Operational requirements	Potential building integration
Solar thermal system	Optimized solar access	Connection between panels, storage tank and adsorption module Prevent energy losses (thermal insulation of tubes and storage) -----	Maintenance of the fluid/water level in both circuits Shadow the system when solar panel are discharged	Solar-exposed surfaces (pitched roof, horizontally, vertically on façade...) Basement or other spaces for tank (sole or for multi-NAC systems)

		Large solar panel surface & heavy thermal storage	Guarantee watertight of junctions (hot temperature) Manage hot surfaces and fluids	
Adsorption module	Rain protection (for adsorption functioning)	Allow and external air connection (intake or recirculation) Two coupled units for continuous functioning Protect surrounding material from deterioration due to the hot surfaces of the element ----- Around 60x80x40 cm for unit	Exhaust the hot air after regeneration faraway from inlet vents Mechanical activation of valves (2 flows) Maintenance of the system – access to valves and water tubes	Lowest part of the NAC-wall Vertical stack elements (chimney, skylight well...) Attached to building facades Partially integrated in an external insulation layer or in a recess
Heat exchanger		Connection with indoor spaces for inputting the treated air Outdoor connection to exhaust the secondary humid flow ----- Around 60x80x20 cm	Possibility to clean turbulators from the dust	Horizontally positioned (lower balcony surface, below windows, between floors...) Vertical positioned (if integrated with evaporative tower or fan supported)
Evaporative tower (indirect)	Reduction in water consumption (recirculation)	Potentially integrated with the heat exchanger Manage the high humidity and water presence ----- Around 30cm Ø and 1.5-2 meters in high	Maintain the water system (nozzles, pump...) Prevent salmonellosis and seaweed formation Guarantee access to all parts	Attached to the building façade (or see [9,10]) Vertical draught elements (chimney, skylight well...) Upper-positioned than the heat exchanger or coupled

4.2. Input/output flows and main natural forces direction of induced airflows

The solar thermal system, whose main output is the hot water for zeolite regeneration, is composed by different sub-elements. Solar panels and the relative fluid recirculation system need a direct solar radiation access, an electrical connection for the recirculation pump, and a fluid-source connection to level the amount of the circulating fluid. The storage tank needs an electrical connection (or a different vector) for the resistors able to guarantee the required water temperature when solar energy is not sufficient. Furthermore, an aqueduct connection is needed to potentially restore the water/fluid level. The regeneration hot water circuit needs an electrical connection for the pump and the valves. Differently, the adsorption system main inputs are the airflow to be treated, hot water for the regeneration, and electricity for controlling valves. Expected outputs are the treated air together with the absorbed water vapor to be further discharged thanks to the hot water circulation. The heat exchanger does not need additional inputs in respect to the two airflows, even if, for some specific spatial organization (see below), a possible electrical connection can be considered for fans. Finally, the evaporative tower needs as inputs the airflow to be treated (external or exhaust one), water or fluid to be evaporated by nozzles, and electricity for the water pump. Outputs are the treated airflow and the not-evaporated water.

The main naturally induced movements of the different considered airflows are described in Table 3.

Table 3. Different combination of the NAC wall technical elements and different airflow directions.

Technical element		▲	▼	◀▶	Notes
Solar thermal system		-	-	-	Pump-driven
Adsorption module	dehum/regen	Naturally induced	Fan forced	Fan forced	
Heat exchanger	Primary	Fan forced *	Naturally induced	Fan forced*	
	secondary	Naturally induced	Fan forced*	Fan forced*	
Evaporative tower		-	Naturally induced	(Fan forced*)	

Figure 8. Possible building integration schemes: (a) technological sketch for a wall-integration of NAC wall system in a single or terraced house; (b) a solution for multi-story building NAC wall systems

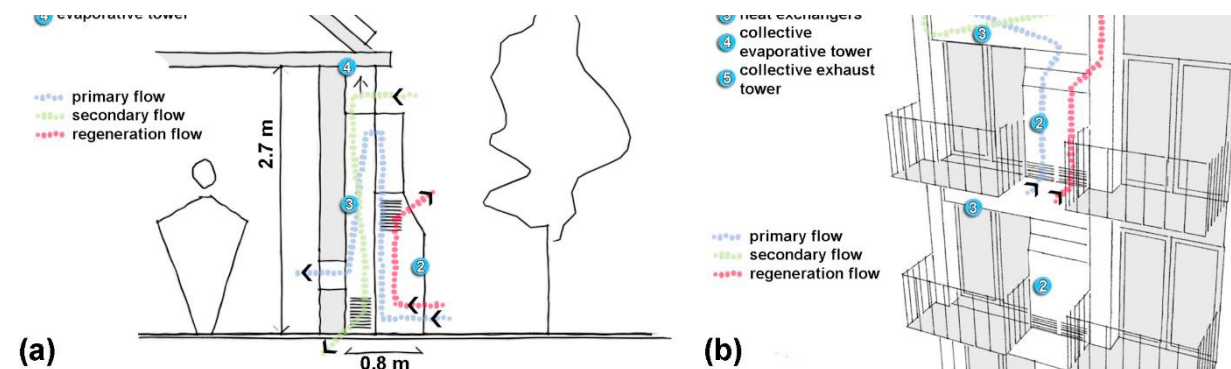

* The fan power depends on the velocity and ΔT reached by the flow in the previous steps (in specific conditions may be avoided).

As it is reported in this table, the primary airflow will be firstly interested by a naturally induced upward movement, due to the increase of the air temperature and decrease in absolute humidity, and after, during the heat exchange phase, by a negative buoyancy force, due to the sensible reduction in temperature. Nevertheless, the first stack-driven movement of the air can partially, or even totally, balance this second downward force. A horizontal positioning of the heat exchanger may decrease the request for additional fan force in comparison with a vertical ascending positioning. Differently, the secondary flow will be interested by a naturally induced downward movement due to the evaporation tower, and after, during the heat exchange phase, to an opposite ascending natural flow due to the increase in temperature. As for the other flow, this second force may be, in some occasion, balanced by the first force allowing to reduce the use of fans. Differently, the regenerating airflow in the adsorption module will follow a vertical natural movement due to the high temperature reached by the zeolite coating and the hot water regeneration system, even if the increasing in absolute humidity will partially counterbalance this effect.

4.3. Possible integration schemes

The integration of a NAC-wall system, at the current state, requires a large amount of free space on building facades [11]. For every typology of buildings, it can be easily integrated into opaque facades, such as in façades without balconies and windows, or in residual spaces between buildings. Further possible integration strategies can consider attaching the system to the opaque-façade areas. Figure 10 (a) shows a schematic section of a possible NAC-wall configuration to be integrated in a single or terraced house, while in (b) is reported a possible integration scheme for a multi-storey building. In this last case, the NAC wall technical elements are differently treated: solar collectors are collective and localized on the roof with a tank storage in the basement, adsorption and heat exchanging modules are individual, while the evaporative tower is collective. A further exhaust air tower is included to easily remove secondary and regenerating airflows, avoiding to release hot humid airflows near to the inlet vents of the other floors.

5. Industrial Barriers to Innovation and development opportunities

It is largely recognized that introducing innovative products in the industry can generate economic, social and environmental benefits. The activities produced by innovative product introduction can generate economic links with the activities carried out around a specific building project, with other industries related or connected to these activities, and with the economic environment on the long-term [12,13]. Therefore, innovation is recognized as a medium of advancement for the industry. If the building sector advances and augments its productivity, consequently the contribution to the broader industry increases, producing secondary social and economic benefit. Although the importance of innovation is largely recognized in the industry, the building sector is often depicted as a slow change type of industry. Many authors [14,15,16,17,18,19,20] explored on a theoretical level dynamics of resistance to change in the building industry. This condition seems to be particularly true for the manufacturers and suppliers, whom are

exposed to a very high degree of risk in undertaking innovative endeavors. Bowley [14] observed reasons and factors that allowed changes in the British industrial building realm over the 20th Century, and pointed out that many changes happened as ersatz rather than through active innovation implementation strategies. Slaughter [17,20], on the basis of management and economic theories [15], described five types of implementation of innovation (incremental, modular, architectural, system, and radical innovation) related to the degree of possible change, as guidelines for companies that are willing to implement innovative activities. Changes and progress in the industry seem to occur incrementally, rather than radically (or by design). Slaughter [17,20] suggested that, in order to decrease the risk level for companies, which are keen to undertake innovative endeavors, it is important to understand the type of innovation and its characteristic, in such way to allow an effective management of the change occurring to their practice. In the case of the NAC wall system, it is significant to consider the degree of innovation that this new product could potentially generate on many levels: the urban, the architectural, and the industrial one, specifically in relation to its supply chain. This is due to the relevance that the product may produce on different scales of analysis. The type of innovation potential of the NAC wall within the context of the industrial production and supply chain could be considered incremental or modular [15]. This type of innovation generally produces a limited impact on the supply chain, in case of incremental development by innovating an existing product, or in case of modular development, changes to core design features can occur. In the case of NAC wall production the supply chain will not be impacted by disruptive changes, as all the components, such as materials and production lines will not require major modifications to the process, as most of the constituting elements are already existing on the market, and the way in which they are assembled are already consolidated processes. Although, a possible NAC wall production could be considered a low risk endeavor for the manufacturer, the design at the level of the building integration could trigger a more impacting effect on the existing practice. The integration at a building level - at the current state of the product development - would represent an architectural innovation, and therefore producing changes in system relation between components [15]. This would be due to the NAC wall dimension, as well as to its location within the building. The impact produced by this sort of innovation would impinge quite heavily on the spatial relation in the building, the layout orientation, the façade design conception, and possibly on the construction systems and sequences required during the erection process. Moreover, on an urban scale, the introduction of the NAC wall could be considered an incremental innovation, which will not necessarily produce any dramatic changes to the current state of practice, exception made for the interface of its appearance and orientation, and the contextual urban environment. The potential innovation introduction that the NAC wall could possibly trigger, can generate the opportunity for industrial growth and development, beside its own environmental value in relation to its functional scope. To facilitate the innovation introduction it is therefore necessary to understand the type of innovation that the new product development could generate, as well as how to manage the potential changes that the practice would have to face. Further development of the product, could assist in decreasing of risk related to its novelty, by refining the type of innovation and the consequential impacts that this can trigger. As previously highlighted, the NAC wall has demonstrated its environmental value, and by continuing refining solutions for its possible architectural integration, it would be possible the development of a highly effective product characterized by a low risk innovation endeavor type.

6. Discussion

The problem of the integration of an air conditioning technology powered mainly by solar thermal power is here investigated by different point of view. The design of the NAC wall as a feasible system, with tangible effect in the mid-term period, requires the parallel analysis of different topics: components optimization; building integration; effects on the production chain.

The type of innovation here presented have a limited impact on the supply chain, because components involved for the production of the system are not disruptive technologies. The production of NAC wall can be a low risk opportunity for manufacturers, to produce a simple system with high efficiency and a high level of utilization of solar thermal energy. Building integration is the main challenge to realize a very attractive system, because it has a relevant impact on the existing practice, and encumbrance is a key-factor. Size reduction of the system can be achieved if the components of a DEC system are reconfigured, and the experimental activities here presented follow this goal by the improvement of dehumidification performances. The combination of heat and mass transfer phenomena using the finned coil heat exchanger with a SAPO 34 coating results a smart way for the regeneration of the adsorption material,

taking advantage by buoyancy phenomena. But residual heat results as a drawback for dehumidification performances. The increase of air flow rate, assisting the natural ventilation by an electrical fan, reduces faster the temperatures, resulting in a smart effectiveness of dehumidification.

Experimental activities shows a specific dehumidification in the interval of 3-7 g/kg, with tested flow rate between 100 and 700 m³/h and functioning period of 15 minutes. COP of this component reach values around 20.

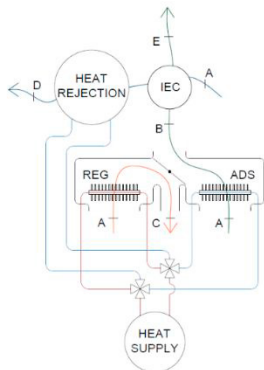

Figure 9. Scheme with heat rejection for cooled adsorption (future)

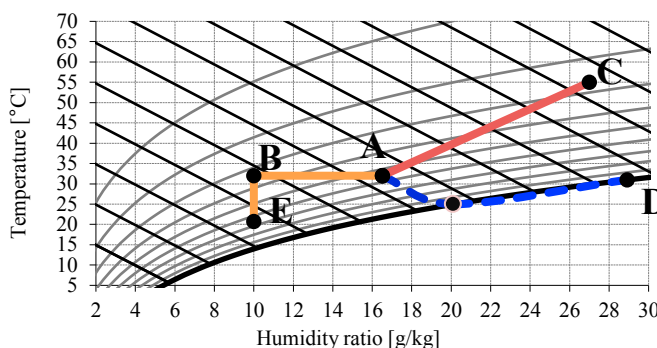

Figure 10. Air transformation on the psychrometric with cooled adsorption (future)

Despite these performances, a better utilization of the adsorption mean can be reached by integrating a heat rejection system to discharge all the residual heat and the adsorption heat to the environment.

Figure 5 and 6 reports future experimental activities on the optimization of the NAC wall prototype. Modification on the current state of the prototype are carried out now in order to realize an isothermal dehumidification as in the transformation A-B of figure 6. The dissipation of the adsorption heat through the residual evaporation of the secondary fluid, coming from evaporative cooling unit (Figure 5). An isothermal dehumidification [21,22,23] can be reached, by rejecting the adsorption heat to the external environment, and supply air temperatures as low as 20 °C are expected (Figure 6). To have an isothermal transformation such as line A-B a specific heat of around 17 kJ/kg has to be rejected to the environment.

7. Conclusions

The NAC wall current state of development has been presented. The measured performance of the system are promising, especially from the point of view of the electrical COP, which in typical summer conditions tests was derived as high as 25. The NAC wall is going to be optimized to further improve its performance. Nonetheless, even in its current operative configuration, the system can be considered a solution with high potential of integration in building facades, both for new and existing buildings. In order to drive its development and to leverage its full potential, the NAC wall must be considered in the context of construction business and the potential barriers to its introduction identified and targeted. Under this point of view, the system presents a low-profile risk, provided that its specific operative limitations and functional constraints are well understood.

References

- [1] H. M. Henning, *Solar-Assisted Air-Conditioning in Buildings – An handbook for planners*, New York, Springer Wien, 2004.
- [2] H. M. Henning, T. Erpenbeck, C. Hindenburg, I.S. Santamaria, The potential of solar energy use in desiccant cooling cycles, *International Journal of Refrigeration*, vol. 24, pp. 220–229, 2001.
- [3] Kabeel A. E., Solar powered air conditioning system using rotary honeycomb desiccant wheel, *Renewable Energy*, vol. 32, pp. 1842–1857, 2007.
- [4] M. Beccali, P. Finocchiaro, B. Nocke, Energy and economic assessment of desiccant cooling systems coupled with single glazed air and hybrid PV/thermal solar collectors for applications in hot and humid climate, *Solar Energy*, vol. 83, pp. 1828–1846, 2009.
- [5] G. Arsignani, A. Capozzoli, F. Minichiello, C. Roselli, M. Sasso, Desiccant wheel regenerated by thermal energy from a microcogenerator:

Experimental assessment of the performances, *Applied Energy*, vol 88, pp. 1354-1365, 2011.

[6] J.L. Niu, L.Z. Zhang, H.G.Zuo, Energy savings potential of chilled-ceiling combined with desiccant cooling in hot and humid climates, *Energy and buildings*, vol. 34, pp. 487-495, 2002.

[7] Simonetti, M., Chiesa, G., Grosso, M., Fracastoro, G. V. ; NAC wall: An open cycle solar-DEC with naturally driven ventilation. *Energy and Buildings*, 129, 2016, pp. 357-366.

[8] Simonetti, M., Gentile V., Fracastoro, G.V., Freni, A., Calabrese, L., Chiesa G.; Experimental testing of the buoyant functioning of a coil coated with SAPO34 zeolite, designed for solar DEC (Desiccant Evaporative Cooling) systems of buildings with natural ventilation; *Applied Thermal Engineering*, 103, 2016, pp. 781-789.

[9] Ford B, Schiano-Phan R, Francis E. *The architecture & engineering of draught cooling*. UK: PHDC press; 2010.

[10] Chiesa G, Grosso M, Bogni A, Garavaglia G. Passive draught cooling system integration in existing residential building typologies: a case study. *Energy Procedia*, 111, 2017, pp. 599-608.

[11] Grosso M, Fracastoro GV, Simonetti M, Chiesa G. A hybrid passive cooling wall system: concept and laboratory testing results. *Energy Procedia* 2015, 78, pp. 79-84.

[12] Pearce D W (2003) *The Social and Economic Value of Construction: The Construction Industry's Contribution to Sustainable Development*, London: CRISP.

[13] Turin D A (1980) 'What do we mean by building', *Habitat International*, No.5, pp. 271-28.

[14] Bowley M, *Innovation in Building Materials, an Economic Study*, Duckworth, 1966.

[15] Gann, D. M., *Building Innovation*. London: Thomas Telford, 1990.

[16] Groak, S., The decline of robust technologies in the building industry, *Building research and Practice*. The Journal of CIB, 2, 1966.

[17] Slaughter S (1993) 'Buildings as a source of construction innovation', *Journal of Construction Engineering and Management*, 119 (3), pp.532–549.

[18] Winch, G., Zephyrs of creative destruction: understanding the management of innovation in construction. *Building Research and Information*, 26(4), 1998, 268-279.

[19] Henderson, M. and Clark K., Architectural Innovation: The Reconfiguration of Existing Product Technologies and the Failure of Established Firms, *Administrative Science Quarterly*, 1990, Vol. 35, No. 1, Special Issue: Technology, Sage Publications, Cornell University.

[20] Slaughter S (2000) 'Implementation of construction innovation', *Building research and Information*, 28(2), 2000, p. 2-17.

[21] Finocchiaro P., Beccali M., Gentile V.; Experimental results on adsorption beds for air dehumidification; *International Journal of Refrigeration*, 63, 2016, pp. 100-112.

[22] Finocchiaro P., Beccali M., Innovative compact solar air conditioner based on fixed and cooled adsorption beds and wet heat exchangers, *Energy Procedia*, 48, 2014, pp. 819-827.

[23] Finocchiaro P., Beccali M., Brano V.L., Gentile V.; Monitoring Results and Energy Performances Evaluation of Frescoo Solar DEC Systems; *Energy Procedia*, 91, 2016, pp. 752-758.