

Verification of RELAP5-3D code in natural circulation loop as function of the initial water inventory

Original

Verification of RELAP5-3D code in natural circulation loop as function of the initial water inventory / Bertani, C; Falcone, N; Bersano, A; Caramello, M; Matsushita, T; DE SALVE, Mario; Panella, B. - In: JOURNAL OF PHYSICS. CONFERENCE SERIES. - ISSN 1742-6588. - ELETTRONICO. - 923:(2017), pp. 1-10. [10.1088/1742-6596/923/1/012008]

Availability:

This version is available at: 11583/2698554 since: 2018-01-30T11:47:18Z

Publisher:

IOP

Published

DOI:10.1088/1742-6596/923/1/012008

Terms of use:

This article is made available under terms and conditions as specified in the corresponding bibliographic description in the repository

Publisher copyright

(Article begins on next page)

PAPER • OPEN ACCESS

Verification of RELAP5-3D code in natural circulation loop as function of the initial water inventory

To cite this article: C Bertani *et al* 2017 *J. Phys.: Conf. Ser.* **923** 012008

View the [article online](#) for updates and enhancements.

Related content

- [Numerical simulation of velocity and temperature fields in natural circulation loop](#)
L A Sukomel and O N Kaban'kov
- [Experimental research of a two-phase nitrogen natural circulation loop](#)
S Reisz, A Bonelli and B Baudouy
- [Experimental study of thermo-hydraulic characteristics of natural circulation loop at water and FC-72 boiling under atmospheric pressure](#)
O N Kaban'kov, L A Sukomel, N O Zubov et al.

Verification of RELAP5-3D code in natural circulation loop as function of the initial water inventory

C Bertani¹, N Falcone¹, A Bersano¹, M Caramello¹, T Matsushita², M De Salve¹ and B Panella¹

¹ Energy Department

Politecnico di Torino

Corso Duca degli Abruzzi 24, 10129 Torino (TO), Italy

² Graduate School of Energy Science

Kyoto University

2-1010 Asasiro-nishi, Kumatori-cho, Sennan-gun, Osaka 590-0494, Japan

E-mail: andrea.bersano@polito.it

Abstract. High safety and reliability of advanced nuclear reactors, Generation IV and Small Modular Reactors (SMR), have a crucial role in the acceptance of these new plants design. Among all the possible safety systems, particular efforts are dedicated to the study of passive systems because they rely on simple physical principles like natural circulation, without the need of external energy source to operate. Taking inspiration from the second Decay Heat Removal system (DHR2) of ALFRED, the European Generation IV demonstrator of the fast lead cooled reactor, an experimental facility has been built at the Energy Department of Politecnico di Torino (PROPHET facility) to study single and two-phase flow natural circulation. The facility behavior is simulated using the thermal-hydraulic system code RELAP5-3D, which is widely used in nuclear applications. In this paper, the effect of the initial water inventory on natural circulation is analyzed. The experimental time behaviors of temperatures and pressures are analyzed. The experimental matrix ranges between 69 % and 93%; the influence of the opposite effects related to the increase of the volume available for the expansion and the pressure raise due to phase change is discussed. Simulations of the experimental tests are carried out by using a 1D model at constant heat power and fixed liquid and air mass; the code predictions are compared with experimental results. Two typical responses are observed: subcooled or two phase saturated circulation. The steady state pressure is a strong function of liquid and air mass inventory. The numerical results show that, at low initial liquid mass inventory, the natural circulation is not stable but pulsated.

1. Introduction

The increasing request for energy supply is a well-recognized problem worldwide. In particular, the request of electricity is expected to grow considerably in the next years mainly due to the development of emerging countries. This fact poses huge challenges for the future also taking into account the efforts that many countries are making to reduce the greenhouse gases emissions. A possible source of



abundant and clean electricity is nuclear energy. Even if the risks related to nuclear are considerably lower than other energy sources, the public opinion is generally against this possibility. This is one of the reasons that have pushed the civil nuclear industry to improve continuously the safety of commercial nuclear power plants. In this framework, the international community is devoting many efforts to develop Generation IV reactors. This new family of nuclear reactors is characterized by improved safety, higher economic benefits and a stronger resistance to nuclear proliferation [1]. This generation includes a wide use of passive systems in particular for the operation of the plant in case of an accident. Passive systems rely on physical principles to operate, without the need of external energy to operate or human intervention [2]. This characteristic offers great advantages particularly concerning safety system that should operate in every condition.

Among the six proposed technologies for Generation IV reactors, Italy is particularly involved in the design of the lead-cooled fast reactor (LFR). The main current project is the design of a European demonstrator of the LFR technology called Advanced Lead Fast Reactor European Demonstrator (ALFRED), which is carried out by FALCON (Fostering ALfred CONSortium) consortium.

The use of lead as coolant offers several advantages, such as good heat transfer properties, neutron and gamma shielding and decay heat removal by natural circulation. On the other hand, some drawbacks should be carefully considered; one of them is the freezing of liquid lead below 600.65 K (327.5°C). This means that inside the reactor this temperature should always been guaranteed, which is relatively easy during the normal operation of the plant but not so obvious in accidental conditions. In case of an accident the reactor is shut down and the emergency cooling is activated. Under this condition the cooling rate needs to be controlled not to reach the lead freezing temperature. The emergency cooling of the reactor is achieved by a Decay Heat Removal system (DHR) that uses water in natural circulation to operate. These systems are constituted by a bundle of bayonet heat exchangers that remove power from the lead transferring it into a water pool where an Isolation Condenser (IC) is submerged.

In the first proposed configuration, the heat removal was so effective that lead freezing emerged as a major issue. Due to this reason Ansaldo Nucleare (one member of the FALCON consortium along with ENEA and Nuclear Research Institute "ICN") proposed an "anti-freezing" system to be added to DHR (Italian Patent MI2013A001778) [3]. This anti-freezing system consists in the addition of non-condensable gases inside the DHR; based on the operating temperature and pressure of the system, the quantity of non-condensable gases is automatically controlled and the excess gas is collected in a dedicated tank. When the temperature of the system decreases during the operation the pressure is reduced and non-condensable gases can enter in the Isolation Condenser. The effect is a deterioration of the heat transfer capacity and a consequent lower reduction rate of the lead temperature [4].

To verify the effectiveness of this system it is important to study the effect of non-condensable gases on natural circulation. Many researches focus on the reduction of the heat transfer coefficient due to the presence of air [5]. This paper focuses on the effect of air on the global system behavior. In addition to the reduction of the heat transfer capability, the position of air in the system is very important because it can create plugs and therefore decrease or stop the water recirculation.

This problem has been studied both experimentally and with computer simulations. The experiments have been carried out on PROPHET facility (PROtotype Passive Heat Exchanger sysTem, whose design has been presented in the 34th UIT Heat Transfer Conference [6]) at Dipartimento Energia of Politecnico di Torino; to perform the numerical simulation the system code RELAP5-3D [7,8,9] has been used. RELAP5-3D is a thermal-hydraulic code developed by Idaho National Laboratories (INL) widely used in the nuclear field for transient analysis of complex systems. The effect of the presence of air in the system has been observed in terms of operative pressure reached at steady state conditions. Pressure and temperature time behaviors have been measured during the transient and compared to the numerical results for several initial water inventory values.

2. Experimental facility and methodology

The experimental facility is a loop consisting of a bayonet heat exchanger (heat source), a condenser (heat sink) and the connection piping [6,10]. All the components are made of stainless steel AISI 304. The heat source consists in two electric heating tapes wrapped around the bayonet heat exchanger for a length of 1.07 m; the total electric nominal power is 1.566 kW at 240 V. In Figure 1 the scheme of the facility is shown, highlighting the position of the instrumentation nozzles and geometrical and physical data of the main components of PROPHET are listed in Table 1.

K-type thermocouples measure the fluid temperature at eight locations (T1-T8, red circles), and the bayonet outer wall temperature in three points (TA, TB and TC, orange circles); two absolute pressure measurements (p1 at the bayonet bottom, and p2 upstream the condenser, green circles) and three differential pressure measurements ($\Delta p1$, $\Delta p2$ and $\Delta p3$, purple circles) are also carried out by Rosemount transducers. The bayonet wall temperatures are measured merely to avoid the electric resistances breakage; in fact the measured values are not reliable because of local distortion of the thermal field at the measurement points.

A thermographic camera was also used to measure the temperature distribution all over the experimental facility.

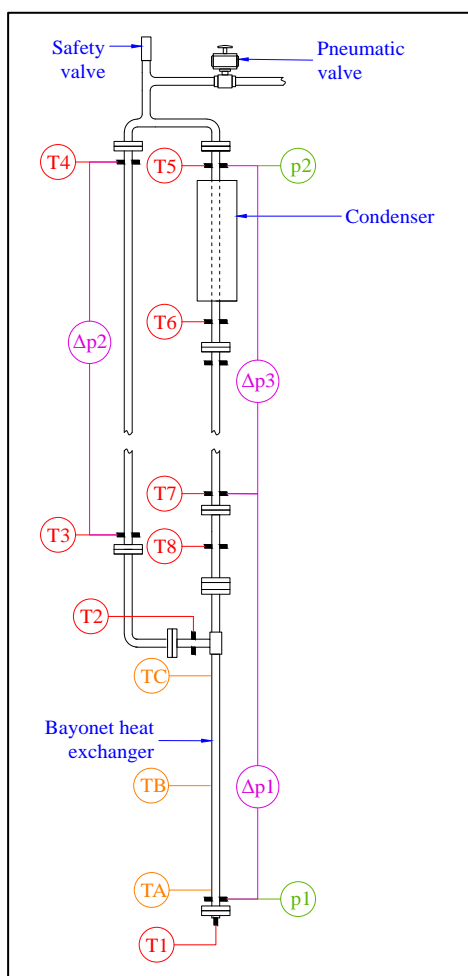

Figure 1: Schematic of PROPHET facility with numbered instrumentation nozzles

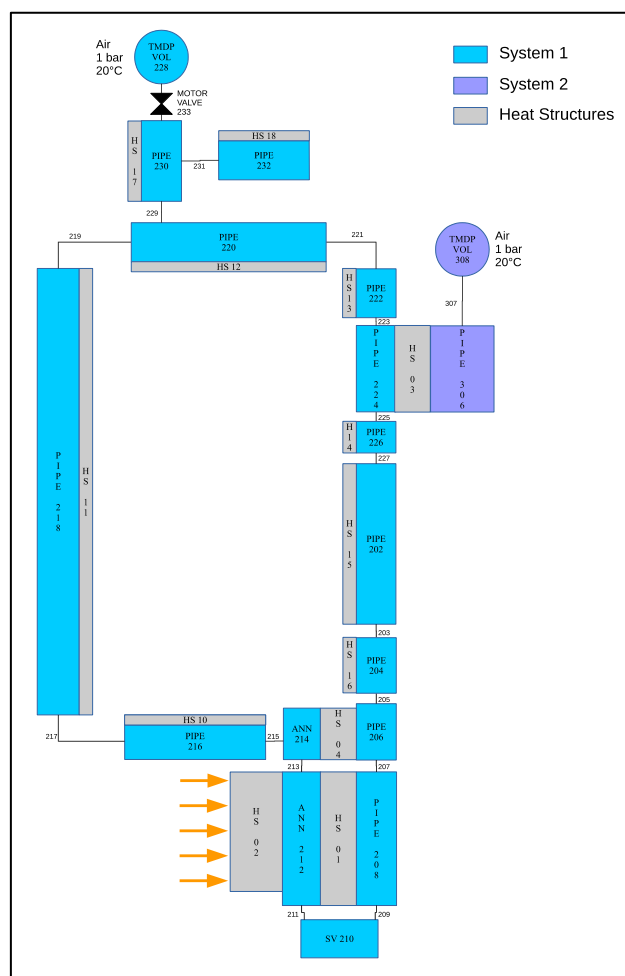

Figure 2: RELAP5-3D nodalization of the facility

Table 1: Geometrical and physical data of PROPHET main components.

Total Volume [dm ³]= 3.20	Volume [dm ³]	% of total	Length [m]	Pipe Heat Capacity [kJ/K]
Bayonet Downcomer (Downward)	0.07	2	1.36	0.16
Bayonet Annulus (Upward)	0.35	11	1.35	3.00
Lower Horizontal Pipe	0.08	3	0.26	0.59
Hot Leg (Vertical Upward)	1.24	39	3.74	8.31
Upper Horizontal Pipe	0.11	3	0.36	0.81
Hot Leg (Vertical Downward)	0.07	2	0.21	0.46
Condenser	0.17	5	0.50	1.12
Cold Leg (Vertical Downward)	0.91	28	2.74	6.10
Connections to Safety/Pneumatic Valves	0.20	6	0.60	1.34
Total	3.20	100	11.12	21.88

The fluid inside the loop is demineralized water. In this experimental campaign, the system was operated in both single-phase and two-phase flow natural circulation with presence of a non-condensable gas (air). Since no insulation has been installed, the actual configuration is characterized by distributed heat sink (along a length of 7.81 m); being the thermal power relatively low, the thermal losses are sufficient to compensate the power provided to the bayonet and therefore the shell-side of the condenser is filled with air. In this configuration the power removed in the condenser is almost negligible with respect to heat losses; moreover, due to heat losses in the hot leg, the average temperature in the pipe is lower, thus the average density is higher and the natural circulation is expected to be reduced.

Seven sets of tests have been carried out filling the circuit with different amounts of water, as shown in Table 2. Because of the geometric configuration of the facility, some air remains trapped in the upper part of the bayonet annulus and in the pipes connecting the cooling loop to the safety valve and to the pneumatic valve. The facility is initially filled completely with water and then a controlled amount of water (0, 100, 200, 300, 400, 600 and 800 g) is discharged. The nominal volume of the loop is 3.20 dm³ and the maximum water inventory has been of 2.98 dm³. Every set of heat-up experiments is composed of five tests with the same initial conditions. The power source is turned on after 1 minute from the beginning of the experiment and maintained constant at 100% for the rest of the transient duration (5 hours in total). The input electric power is 1.75 kW; the heat losses of the heating tapes have been measured to be around 30%, so the effective input thermal power is 1.225 kW. At the end of each experiment the remaining mass in the loop has been measured. The standard deviation has been evaluated for both the mass in the loop and the steady state operating pressure. The data acquisition is performed with a dedicated LabVIEW program, which has been specifically designed for the facility using a timestep of 0.1 s

Table 2: Reference test matrix.

Run	1	2	3	4	5	6	7
Liquid mass [kg]	2.98	2.88	2.78	2.68	2.58	2.38	2.18
Filling ratio [%]	93	90	87	84	81	75	69
Initial void fraction [%]	7	10	13	16	19	25	31
Estimated initial air volume [dm³]	0.22	0.32	0.42	0.52	0.62	0.82	1.02
Air mass (p=1.01325 bar, T=20 °C) [g]	0.313	0.434	0.554	0.674	0.795	1.036	1.277

3. RELAP5-3D Model

The experimental transients have been simulated by RELAP5-3D, which is a widely-used code to simulate thermal hydraulic transients in nuclear reactors. The adopted nodalization is shown in Figure 2. System 1 represents the main loop in PROPHET facility, and system 2 the condensation pool.

The bayonet heat exchanger is composed by a downcomer region simulated by pipes 206 and 208, an inversion chamber (single volume 210), and an annular riser represented by annulus 212 and 214. Heat structures 01 and 04 represent the inner pipe wall that separates the downcomer from the annulus, through which regenerative heat transfer occurs. Heat structure 02 represents the external wall of the bayonet and a constant heat flux boundary condition is imposed on its outer surface.

The condenser consists of pipe 224 which is concentric with an annular pool simulated by pipe 306. In the condenser heat is transferred from the fluid of pipe 224 to the one in pipe 306 by the heat structure 03. Pipe 306 is connected to time dependent volume 308 to simulate the ambient boundary conditions (air at 20°C and 1 bar). All the network piping except for the bayonet and the condenser (which in this case is full of air) are connected to heat structures to simulate the heat losses to the environment. Time dependent volume 228 and motor valve 233 model the safety valve connected to the experimental facility. The valve opens if the pressure in the loop exceeds 7 bar and closes when it returns below 6 bar. In the upper part of the facility, pipe 230 and pipe 232 model respectively the vertical connection to the safety valve and the horizontal connection to the pneumatic valve used to discharge water and air during the filling procedure of the facility.

Convective boundary conditions have been imposed on heat structures from 10 to 18. The heat transfer coefficient on the surface of heat structures was determined as the sum of the contributions of free external convection and radiative heat transfer. Its value has been tabulated as a function of the wall temperature and provided as input to RELAP5-3D.

Regarding the initial conditions, both water and air are initially present in the experimental facility loop, while the shell-side of the condenser (pipe 306) contains only air. The initial water inventory in the loop is adjustable by selecting the initial amount of water that fills each component's volumes. The total facility volume computed by RELAP5-3D differs by 1% from the measured one (effect of a discrete nodalization and of the curves shape). For this reason, the measured mass inventory and the numerical one differ by 1% for comparable percentages of initial fillings. Non-equilibrium model is adopted everywhere.

4. Results and discussion

Experimental heat-up transients have been carried out with seven initial masses ranging from 2.19 kg to 2.98 kg, which corresponds to the maximum possible filling of the loop.

The experimental results showed that, at high percentage on initial filling, single-phase natural circulation occurs and that at the end of the heat-up transient steady state values of pressures and temperatures are reached. On the other hand, at lower percentages of initial filling, two-phase flow natural circulation is reached and instability phenomena related to this specific flow regime occurs, which induces oscillations in the measured values of pressure and temperatures along the loop.

This chapter will first of all analyse the experimental results of two tests, one of high percentage of filling (~ 91%) and the other at low percentage (~ 69%), and compare them with the predictions of RELAP5-3D. In the condition of initial percentage of filling equal to 91% the water inventory is equal to 2.96 kg and the air-water interface is located in pipe 220. With an initial percentage of filling of 69% the water inventory is equal to 2.25 kg and the air-water interface is located between pipe 226 and pipe 202. For every experimental test, the average values of pressure during the last 500 s of the transient have been evaluated. The range of oscillation of each parameter around its average value is negligible in the test of high filling percentage, while it is more relevant at low filling percentage because of the occurrence of two-phase natural circulation instabilities. Similarity, also the average

values of the parameters evaluated by RELAP5-3D have been calculated. In the final part of this chapter, experimental and predicted steady-state average values of pressure are compared.

4.1. Pressure and temperature history

Figure 3, Figure 4 and Figure 5 present the history of the absolute pressure in the bayonet inversion chamber, as well as of the bayonet inlet and outlet temperatures for two water inventories: a high one (about 91% of the filling) that corresponds to liquid single phase flow, and a relatively low one (about 69% of the filling) at which there is two-phase flow. Each experimental result is compared with two different simulations by RELAP5-3D.

The first simulation (Simulation A) is performed with an input thermal power to the bayonet of 1225 W. This value is the result of several single-phase tests performed in forced circulation by inserting a pump in the loop. The measurement of the mass flow rate and of the temperature difference in the bayonet allows the computation of the thermal power received by the water in the bayonet. The obtained value is lower than the electric power provided to the heater, since a part of it is dissipated to the environment. From Figure 3 it can be seen that even if the shapes of predicted and experimental pressures are very similar, the agreement at the end of the transient is not satisfying.

The analysis of the fluid temperatures predicted by RELAP5-3D shows that temperatures in pipes 230 and 232 were much lower than the temperature of the pipes outer surface revealed by the thermographic camera. This is due to the fact that no net flow occurs through pipes 230 and 232 and, using a one-dimensional modeling, RELAP5-3D is not able to describe the recirculation phenomena actually occurring inside these pipes. The underestimation of the temperature in such volumes results in an underestimation of the pressure.

In order to improve the prediction, a second simulation set (Simulation B) has been performed: a lower power to the bayonet is used (1150 W) and the critical components (pipe 230 and 232) have been considered adiabatic by removing the heat structures connected to them; in this way, the predicted temperatures reach the value comparable with the upper part of the loop. The outer surface of these pipes corresponds to approximately 6% of the networking piping and condenser surface; in order to compensate for the lower heat transfer surface to the environment, the thermal power to the outer surface of the bayonet has been reduced of 6%, which lead to a power of 1150W.

The boundary conditions of Simulation B improve the overall prediction, but the final pressure is slightly overestimated.

The absolute pressure in the inversion chamber in both simulations are reported together with the experimental data in Figures 3a and 3b respectively for high and low percentages of filling.

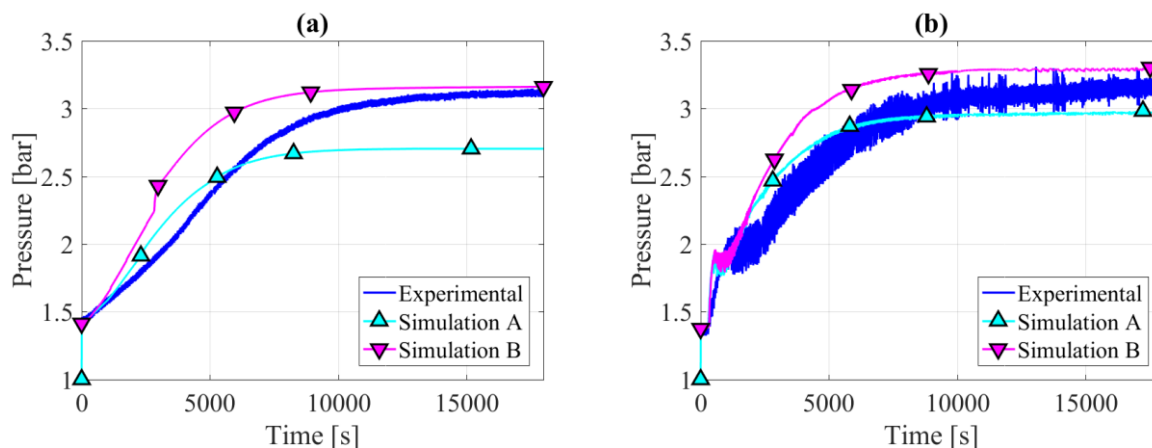

Figure 3: Bayonet inversion chamber pressure for high (~91%) and low (~69%) percentage filling.

It can be seen that, except for the first part of the transient, the experimental results are in between the two numerical prediction for both high and low percentage of filling, but the predictions by Simulation B are in general the best ones as regards the final steady state values of the thermal-hydraulic parameters. Therefore, only the prediction obtained by Simulation B will be compared with the experimental results from now on.

Figures 3a and 3b shows that the pressure curve for high water inventory is smooth and neat; on the other hand, at lower initial filling the pressure presents relevant fluctuations due to the occurrence of the pulsated two-phase flow in the loop. Conditions in the bayonet are very similar to pool boiling with intermittent flow and high pressure and pressure drop oscillations, which also affect the fluid temperature history.

The experimental and predicted temperature time behaviors at the bayonet inlet and outlet at high percentage of filling, together with the saturation temperature, are plotted respectively in Figures 4a and 4b; there is a good matching between experimental and predicted values in the first part of the transient, while the code slightly underestimates the temperatures (approximately 10°C) once the steady state conditions are reached. Since the temperature at both the bayonet inlet and outlet always remains below the saturation value, natural circulation of subcooled liquid occurs in the loop at initial high percentage of filling.

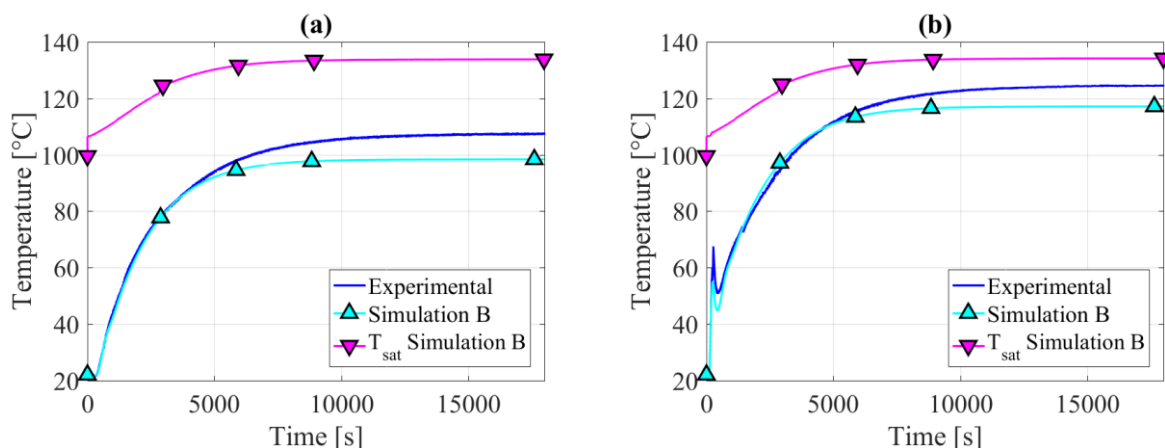

Figure 4: Bayonet inlet and outlet temperature for high percentage of filling (~ 91%)

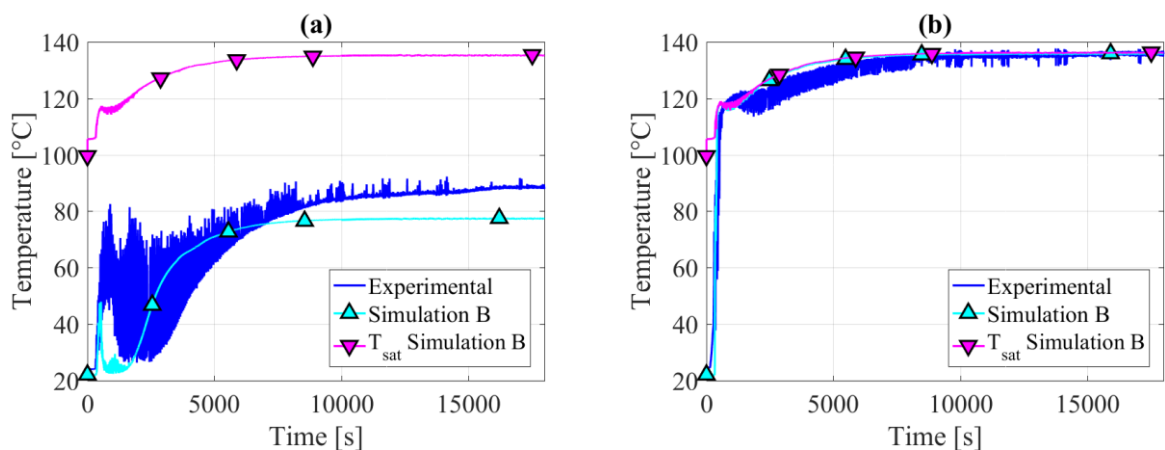

Figure 5: Bayonet inlet and outlet temperature for low percentage of filling (~ 69%).

The history of experimental and predicted temperatures at the inlet and at the outlet of the bayonet at low percentage of filling is plotted in Figure 5a and 5b. Unlike the previous case, wide oscillations

occurred during the experiments, especially during the first half of the transient; during this period of time, higher discrepancies are also found between experimental temperature at the bayonet inlet and the values predicted by Simulation B.

Since saturation temperature is reached at the bayonet outlet (Figure 5b), this test is characterized by two-phase natural circulation, which shows oscillations due to pulsated flow. Moreover, the simulation results show that air tends to be collected at the top and in the coldest part of the loop (condenser and cold leg). The experimental bayonet outlet temperature trends are in good agreement with the predicted results, even though the oscillations are not predicted by the code. The strong temperature oscillations at the bayonet inlet (with peaks larger than 40°C) are related to the pulsated flow in the loop due to the mixing with cold water that intermittently flows in the cold leg.

Comparing the two test conditions, the experimental temperature at the bayonet inlet is considerably higher at high water inventory (20°C higher than at low mass inventory). The temperature at the bayonet outlet, instead, is slightly higher in the low water inventory case. Looking at the plots it can be seen that, assuming the upper part of the loop is adiabatic, good results are found for the pressure history, whereas the temperature behavior is not well reproduced. The discrepancies between experimental and predicted temperatures might be due to the reduction of the power for the adiabatic assumption.

4.2. Steady state operating pressure and mass flow rate

After having analyzed two characteristic cases representative for high and low water inventory, the steady state absolute pressure and the predicted mass flow rate have been plotted as a function of the percentage of filling.

Figure 6 presents the final steady state pressure in the bayonet inversion chamber (the lowest part of the loop), by comparing the experimental results with the ones predicted by RELAP5-3D in both Simulations A and B. The experimental results show a minimum for the pressure (at approximately 87% of filling), which represents a boundary between two regions:

- a region of higher initial inventory (greater than 87%), where a stable single-phase natural circulation occurs; the pressure decreases rapidly as the initial filling decreases because of the increase of the available expansion volume.
- a region of relatively low initial filling (lower than 87%), where boiling occurs in the bayonet; the lower the initial filling is, the higher is the amount of liquid that undergoes the phase change and therefore the higher is the final pressure. In this condition, the instability of the two-phase flow increases as the water mass decreases and the oscillations become larger.

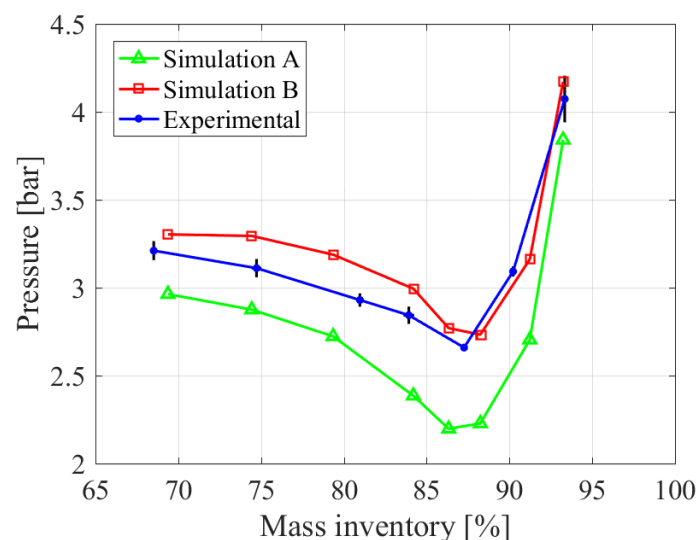

Figure 6: Steady state experimental and predicted pressure in the bayonet inversion chamber

As mentioned in the previous section, the numerical Simulation A is widely underestimating (~ 0.5 bar) the absolute pressure with respect to the experimental results. The Simulation B is slightly overestimating it, but it better represents the experimental trend.

Figure 7 shows the predicted values of the steady state mass flow rate through the loop (evaluated at the inlet of the bayonet heat exchanger) in the two simulations. The vertical bars reported in the figure represent the amplitude of the oscillations at the end of the heat-up transient, computed as standard deviations of the data.

The predicted value are particularly low and, at present, a comparison with measured values is not possible. Nevertheless, it is reasonable to suppose that, similarly to the pressure curves, the actual value of the flow rate will be within the range delimited by the results of simulations A and B.

The difference between the values predicted by the two simulations is very low; both curves show a constant mass flow rate value for high water inventory ($>87\%$ of filling). Below this limit value, the flow rate tends to decrease for decreasing initial fillings, since the natural driving force is reduced by the increasing amount of air present in the loop.

Anyway the experimental results show a strong increase of oscillations for decreasing initial water inventories. This is an indication of the instability of the flow that becomes pulsated as the air in the loop increases.

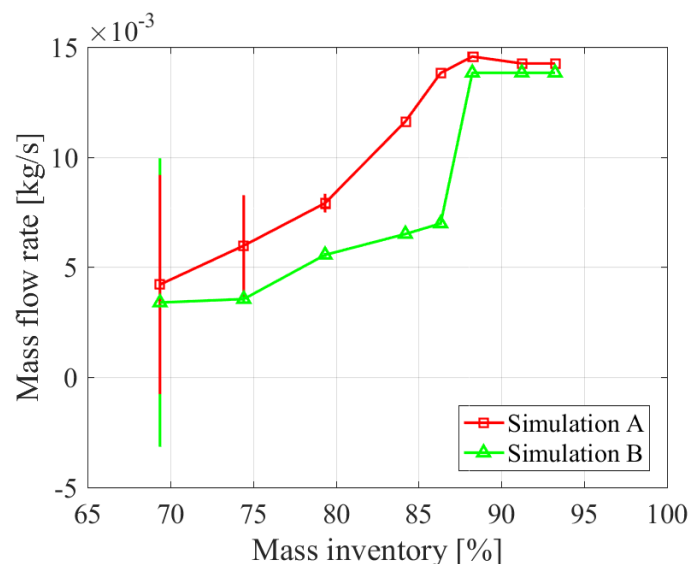

Figure 7: Steady state predicted mass flow rate at bayonet inlet

5. Conclusions and future work

All the proposed Generation IV reactors adopt several passive systems to enhance their safety. One possible safety system is the removal of the decay heat through natural circulation. To study natural circulation in decay heat removal system, the PROPHET facility has been built and tested at Politecnico di Torino.

In this experimental campaign, the effect of the presence of non-condensable gases on natural circulation has been studied both experimentally and with RELAP5-3D simulations. The aim is not focused on the heat transfer coefficient reduction due to the presence of air but on the effect of air on the overall system behavior. The most significant experimental result is the beginning of a pulsated circulation for low water inventories. If the air quantity is significant and the water circulation path is interrupted, there is the beginning of oscillations that become stronger as the air in the system increases.

Simulations performed using the RELAP5-3D code show generally a good agreement with experimental results. Steady state operative pressure is correctly reproduced for different water inventory values. Non-negligible discrepancies have been noticed in correspondence of the connection between the system and the safety and pneumatic valves, where the air temperature is strongly underestimated by the 1-D simulation with RELAP5-3D. These differences are probably due to the presence of two pipes filled with air, through which the net flow is null. The adopted nodalization seems unable to describe local phenomena of fluid recirculation. The present paper shows that some improvements can be obtained by considering adiabatic these pipes. Nevertheless, in future works, the multidimensional component available in the newest version of RELAP5-3D will be used in order to further improve the predictions.

The facility configuration is, at present, characterized by a heat sink distributed along the networking piping. The installation of pipe insulation is planned, in order to rise the temperature level in the system and to enhance the natural circulation. By reducing the thermal losses to the environment and by increasing the heat removal in the condenser, the accuracy of the experimental measurements will increase and the flow instabilities will likely be reduced.

Acknowledgments

The present research has been supported by ENEA and by the Italian Ministry of Economic Development (PAR 2016). Thanks to Rocco Costantino for the technical support in the laboratory.

References

- [1] Nuclear Energy Agency (NEA) on behalf of the Generation IV International Forum (GIF) 2014 *OECD Nuclear Energy Agency*
- [2] International Atomic Energy Agency (IAEA) 1991 *IAEA-TECDOC-626*
- [3] Alemberti A 2015 *Consultants' Meeting: Education Training Seminar on Fast Reactors Science and Technology (ITESM Campus Santa Fe, Mexico City, 29 June – 03 July 2015)*.
- [4] Caramello M, Gregorini M, Bertani C, De Salve M, Alemberti A and Panella B 2017 *Prog. Nucl. Energy* **99** 127-139
- [5] Huang J, Zhang J and Wang L 2015 *Appl. Therm. Eng.* **89** 469-484
- [6] Bertani C, De Salve M, Caramello M, Falcone N, Bersano A and Panella B 2017 *J. Phys. Conf. Ser.* **796** Number 1 1-10
- [7] The RELAP5-3D© Code Development Team 2015 *Idaho National Laboratory INL/MIS-15-36723*
- [8] The RELAP5-3D© Code Development Team 2015 *Idaho National Laboratory INL/MIS-15-36723*
- [9] The RELAP5-3D© Code Development Team 2015 *Idaho National Laboratory INL/MIS-15-36723*
- [10] Caramello M, Gregorini M, De Salve M, Bertani C, Alemberti A and Panella B 2015 *Proc. ICAPP – Int. Cong. on Advances in Nuclear Power Plants (Nice 3-6 May 2015)* pp 41-48