

Thermodynamic Analysis of Beam down Solar Gas Turbine Power Plant equipped with Concentrating Receiver System

*Original*

Thermodynamic Analysis of Beam down Solar Gas Turbine Power Plant equipped with Concentrating Receiver System / Uddin, Azhar; Santarelli, Massimo. - In: JOURNAL OF PHYSICS. CONFERENCE SERIES. - ISSN 1742-6588. - 745:3(2016), p. 032011. [10.1088/1742-6596/745/3/032011]

*Availability:*

This version is available at: 11583/2683107 since: 2017-09-28T10:51:10Z

*Publisher:*

Institute of Physics Publishing

*Published*

DOI:10.1088/1742-6596/745/3/032011

*Terms of use:*

This article is made available under terms and conditions as specified in the corresponding bibliographic description in the repository

*Publisher copyright*

(Article begins on next page)

PAPER • OPEN ACCESS

# Thermodynamic Analysis of Beam down Solar Gas Turbine Power Plant equipped with Concentrating Receiver System

To cite this article: Azharuddin and Massimo Santarelli 2016 *J. Phys.: Conf. Ser.* **745** 032011

View the [article online](#) for updates and enhancements.

## Related content

- [Simulation of solar chimney power plant with an external heat source](#)  
Azeemuddin Islamuddin, Hussain H Al-Kayiem and Syed I Gilani
- [Raman sensor system for gas analysis](#)  
J Kiefer, T Seeger, S Steuer et al.

# Thermodynamic Analysis of Beam down Solar Gas Turbine Power Plant equipped with Concentrating Receiver System

Azharuddin<sup>1,2</sup>, Massimo Santarelli<sup>2</sup>

<sup>1</sup> Department of Fuel Technology, AGH University of Science and Technology, Krakow.

<sup>2</sup> Department of Energy Technology, Politecnico di torino, Italy.

E-mail: [azhar@agh.edu.pl](mailto:azhar@agh.edu.pl)

**Abstract.** Thermodynamic analysis of a closed cycle, solar powered Brayton gas turbine power plant with Concentrating Receiver system has been studied. A Brayton cycle is simpler than a Rankine cycle and has an advantage where the water is scarce. With the normal Brayton cycle a Concentrating Receiver System has been analysed which has a dependence on field density and optical system. This study presents a method of optimization of design parameter, such as the receiver working temperature and the heliostats density. This method aims at maximizing the overall efficiency of the three major subsystem that constitute the entire plant, namely, the heliostat field and the tower, the receiver and the power block. The results of the optimization process are shown and analysed.

## 1. Introduction

The reduction of fossil-fuel based power production by using solar power technology is one important step in the international commitment of CO<sub>2</sub> reduction. The direct way of producing electric power from solar energy, the photovoltaic technology (PV), is gradually extending its focus from purely decentralized small-scale systems towards large-area bulk power production but still the cost of this kind of power generation plants is very high. Presently, there are number of projects related concentrating solar powered systems are initiated and summed up to 7 GW are under planning and development, in addition to 10 GW in Spain, which all could be running from 2017 [1]. The other way of power generation is thermal conversion of solar energy into electricity by using either Rankine cycle or Brayton cycle. To trap the solar energy a central solar receiver may be used to operate the cycle. In the Rankine cycle, steam is generated at low temperatures may be around 540-600°C, by using the solar energy in the receiver, but the pressure must be high [2]. Gas can operated in the Brayton cycle at a higher temperature, say 800°C, while keeping the pressure lower. As the temperature attained is very high in Brayton cycle, thus the efficiency will be high [3].

Theoretically, from thermodynamics perspective, processes that convert heat to work and electricity should preferably operate at as high temperatures as possible, due to the limitations imposed by the Carnot efficiency. In practice, the achievement of high temperatures through solar energy depends on the performance of the optics of the concentrating devices and the ability to design and build an efficient receiver that absorbs and converts the solar radiation to heat. Based on the

---

<sup>1</sup> To whom any correspondence should be addressed.



experience of the past experiments it is known that the maximum temperature by the receiver can be attained below 1200°C because of the characteristics of the receiver used so far.

Reflective solar collectors are used to attain the temperature required for the operation of the thermodynamic cycles. In Central Receiver System (CRS), the solar receiver is mounted on the top of the tower and sunlight is concentrated by means of a large paraboloid that is discretized into a field of heliostats. Typical optical concentration factor ranges from 200-10000 and plant sizes of 10-200 MW are chosen because of economy to scale constraints, even though advanced integrated schemes are claiming economic sense for smaller units also. The high solar flux from the sun on the receiver (300-1000 KW/m<sup>2</sup>) allows working at high temperature up to 1000°C [4-6]. CRS can easily integrate with fossil plant for hybrid operation in a wide range of options or have the potential to generate electricity with high annual capacity factors by using thermal storage. With storage, CRS plants have the capacity to operate more than 4500 hrs/year at normal power.

## 2. Mathematical model

The main objective of the study is to determine the parameters which can maximize the overall efficiency of the system and the optimal working temperature of the receiver. The analysis combines the performance of the solar energy collector, receiver and the gas turbine Brayton cycle. For the analysis the whole system is divided into three units, the collecting subsystem (the optical path), and the receiver—mounted in a beam down solar tower or placed on the ground in the case where a tower reflector is used and the power conversion subsystem as shown in Figure 1 and Figure 2. Segal and Epstein [3] showed a secondary or terminal concentrator mounted in the front of a receiver increases its efficiency, if the required temperature is above 1000 K. The design of such a system essentially involves the determination of the size, type and configuration of each of the subsystems, which would maximize a certain performance criterion (and/or minimize a certain cost criterion), while satisfying the technical specifications and performance requirements [7, 8]. The computation approach described in this study considers each subsystem separately. Hence, the overall system efficiency, overall, can be written as the product of the three subsystem efficiencies as given in equation (1).

$$\eta_{overall} = \eta_{opt} \cdot \eta_{rec} \cdot \eta_{pb} \quad (1)$$

Where  $\eta_{opt}$  is the efficiency of the optical path prior to the receiver secondary concentrator entrance plane,  $\eta_{rec}$  is the efficiency of converting the sunlight to heat in the receiver (including the optical losses in the terminal concentrator and the receiver), and  $\eta_{pb}$  is the efficiency of conversion of heat to electricity (or mechanical work) in the power block. Therefore, to obtain the overall efficiency individual efficiency of the subsystem is to calculate separately.

The collector field comprises sun tracking mirrors (heliostats) focusing the light on a common single aim point or an array of aim points situated on the tower. At the aim point we can consider it to be either a cavity or external receiver. An optical configuration shaped of hyperboloid mirror with one of its foci at the aim point of the collector subsystem. It intercept the concentrated radiation and reflects it downwards to the second focus [9, 10]. This pattern reduces the concentration but allows the terminal concentrator and the receiver subsystem on the ground. Concentration can be recovered and can be enhanced by using a compound parabolic collector.

### 2.1. Efficiency of Solar Field and Receiver

The receiver efficiency is defined as the net power absorbed by the receiver as useful heat divided by the total power reaching at the receiver concentrator entrance plane. The Receiver Concentrator (RC) with circular entrance having radius R that intercepts an amount of power  $P_{ap}$  and a portion of the total power  $P_t$  that reaches the aperture plane. The efficiency of the receiver is formulated as equation (2) [11].

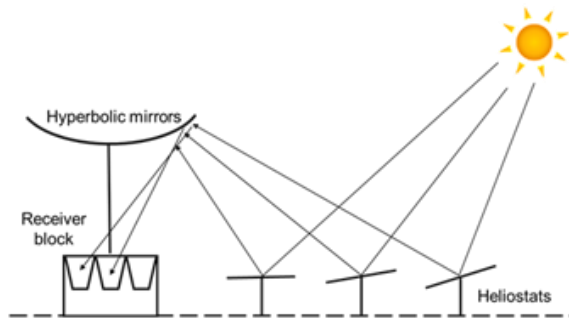

**Figure 1.** Beam-down solar tower with concentrating receiver system.

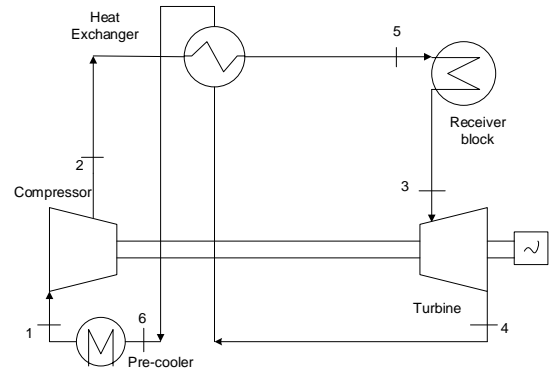

**Figure 2.** Schematic of beam down closed loop solar Brayton cycle.

$$\eta_{rec} = [\alpha_{eff} (P_{ap} - P_{rej} - P_{abs}) - (P_{rad} + P_{nc})] / P_t \quad (2)$$

Where,  $\alpha_{eff}$  is the effective absorptivity of the receiver,  $P_{rad}$  is the amount of power lost by re-radiation from the cavity.  $P_{nc}$  is the power lost by natural convection,  $P_{abs}$  is the power absorbed by the RC surface. It is assumed that receiver is well insulated and the losses due to conduction are neglected.

## 2.2. Power Block Efficiency

In the present study, a closed loop Bryton cycle is considered with Helium as working fluid which solar heat source provided by beam down central receiver block system. In order to improve the efficiency and to increase the temperature a heat exchanger is considered after the compressor. The following are the related equations to calculate the parameters of the cycle.

The Temperature equivalent of the compressor work is given by equation (3).

$$T_2 - T_1 = T_1 \cdot \frac{(r_c)^m - 1}{\eta_c} \quad (3)$$

Where  $r_c$  is compressor pressure ratio and  $m$  is the adiabatic index.

$$r_c = P_2 / P_1 \quad (4)$$

$$m = (\gamma - 1) / \gamma \quad (5)$$

$$\gamma = C_p / C_v \quad (6)$$

The Turbine work requires to run the compressor per unit mass flow can be calculated by equation (7).

$$W_{tc} = C_p \cdot T_3 \cdot \theta \cdot \frac{(r_c)^m - 1}{\eta_c \cdot \eta_m} \quad (7)$$

Where,  $\theta = T_1 / T_3$ ; Ratio of Solar lower to higher temperature in cycle.

In terms of turbine efficiency is represented by equation (8).

$$\eta_t = \frac{(T_3 - T_4)}{T_3 \cdot (1 - (r_t)^{-m})} \quad (8)$$

Where  $r_t$  is determined with equation (9), (10) and (11).

$$r_t = r_c \cdot \frac{1 - \Delta P_2}{1 + \Delta P_1} \quad (9)$$

$$\Delta P_1 = (\Delta P_{hh} / P_1) + (\Delta P_{pc} / P_1) \quad (10)$$

$$\Delta P_2 = (\Delta P_s / P_2) + (\Delta P_{hc} / P_2) \quad (11)$$

The Turbine work per unit mass flow in terms of compression ratio  $r_c$  is given by equation (12).

$$W_t = C_p \cdot T_3 \cdot \eta_t \cdot \Psi \cdot (1 - (r_c)^{-m}) \quad (12)$$

$$\Psi = \frac{1 - (r_t)^{-m}}{1 - (r_c)^{-m}} \quad (13)$$

$$\Delta P = \Delta P_1 + \Delta P_2 \quad (14)$$

A heat exchanger is considered before the solar receiver to achieve high temperatures which in turns increases the efficiency of the cycle. Hence, the temperature of the gas entering the solar receiver after the heat exchanger  $T_5$  can be calculated by expression (15).

$$T_5 / T_3 = \theta \cdot (1 - \varepsilon) \cdot \left(1 + \frac{r_c^m - 1}{\eta_c}\right) + \varepsilon \cdot (1 - \eta_t \cdot \Psi \cdot (1 - (r_c)^{-m})) \quad (15)$$

Heat Supplied by the solar receiver block after the beam down solar tower is expressed by equation (16).

$$Q = C_p \cdot T_3 \cdot \left(1 - \left(\theta \cdot (1 - \varepsilon) \cdot \left(1 + \frac{r_c^m - 1}{\eta_c}\right) + \varepsilon \cdot (1 - \eta_t \cdot \Psi \cdot (1 - (r_c)^{-m}))\right)\right) \quad (16)$$

The Efficiency of the power block is derived as equation (17).

$$\eta_{pb} = \frac{\left( \eta_t \cdot \left( \frac{r_c^m - 1 - m \cdot \Delta P}{r_c^m} \right) - \frac{\theta \cdot (r_c^m - 1)}{\eta_c \cdot \eta_m} \right)}{\left( 1 - \left( \theta \cdot \left( 1 + \frac{r_c^m - 1}{\eta_c} \right) \cdot (1 - \varepsilon) + \varepsilon \cdot \left( 1 - \eta_t \cdot \left( \frac{r_c^m - 1 - m \cdot \Delta P}{r_c^m} \right) \right) \right) \right)} \quad (17)$$

For maximum efficiency, the system should work on optimum pressure ratio  $r_{c,opt}$  which is derived by differentiating efficiency equation with respect to  $r_c$  and equation to zero. The optimum pressure ratio is given by equation (18).

$$r_{c,opt} = \left( \frac{-X_2 - (X_2^2 - 4 \cdot X_1 \cdot X_3 \cdot (1 + m \cdot \Delta P))^{0.5}}{2 \cdot X_1} \right)^{1/m} \quad (18)$$

Where  $X_1$ ,  $X_2$  and  $X_3$  are given by equation (19), (20) and (21).

$$X_1 = \left( \frac{\theta}{\eta_c \cdot \eta_m} \right) \cdot ((1 - \varepsilon) \cdot (\theta + \eta_t \cdot \eta_m) + 3 \cdot \varepsilon \cdot (\eta_t - 1) - 1) \quad (19)$$

$$X_2 = 2 \cdot \varepsilon \cdot (1 - \eta_t) \cdot \left( \eta_t + \frac{\theta}{\eta_t \cdot \eta_m} \right) - \left( 2 \cdot \theta \cdot \eta_t \cdot \frac{1 + m \cdot \Delta P}{\eta_c \cdot \eta_m} \right) \cdot (\varepsilon + \eta_m \cdot (1 - \varepsilon)) \quad (20)$$

$$X_3 = \eta_t \cdot \left( (1-\varepsilon) \cdot (1-\theta + \theta / \eta_c) + \left( \theta \cdot \frac{\varepsilon}{\eta_c \cdot \eta_m} \right) + 2 \cdot \varepsilon \cdot \eta_t \right) \quad (21)$$

The pressure loss coefficient can be found by the equation (22).

$$\Delta P_{max} = \left( \frac{r_c^m - 1}{m} \right) \cdot \left( 1 - \theta \cdot \frac{r_c^m}{\eta_c \cdot \eta_m \cdot \eta_t} \right) \quad (22)$$

Based on the analysis, optimum parameters are to be calculated in order to improve the power conversion.

### 3. Result and discussion

For the analysis, the Helium gas is used with  $C_p=5.193$  kJ/kg-K; adiabatic index  $m=0.3999$ ;  $\gamma=1.666$ .

The following typical values of the component efficiencies are used;  $\eta_c=0.85$ ;  $\eta_m=0.99$ ;  $\eta_t=0.87$  and heat exchanger effectiveness  $\varepsilon$  varies from 0.7 to 0.8. The analysis is break down in to three different system as mention earlier. Figure 3 shows the variation of power block efficiency for different pressure ratios and ratios of the lower to higher temperature in the cycle. As  $\theta$  decreases or the maximum cycle temperature increases, the efficiency also increases and there is an optimum compression pressure ratio for any value of  $\theta$  which can be found by the equation (18).

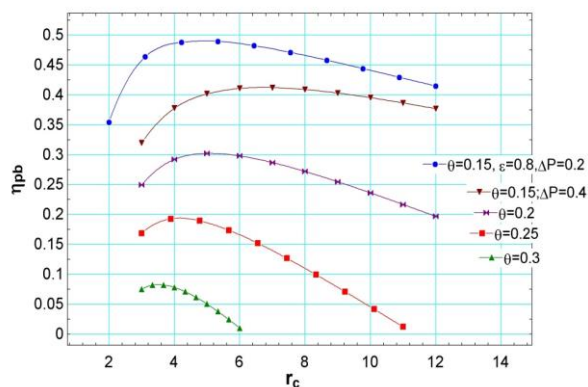

**Figure 3** Variation of Power block efficiency with Compression ratio for different  $\theta$

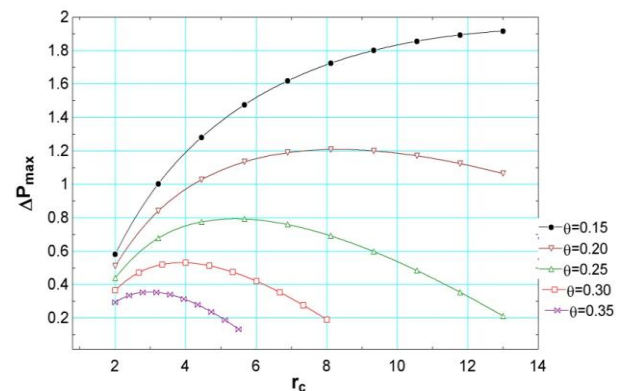
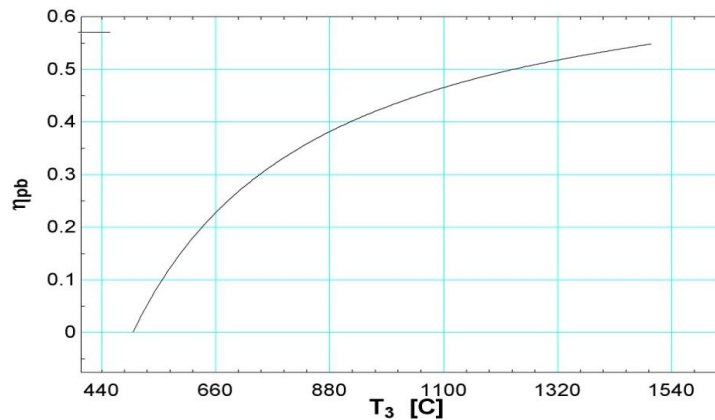

**Figure 4** Variation of  $\Delta P_{max}$  versus compression pressure ratio with different  $\theta$  values.

The effect of heat exchanger effectiveness and the pressure loss coefficient are also shown in Fig 3. For any value of  $\theta$ , as the compression pressure ratio increases, the effect of heat exchanger effectiveness become insignificant; whereas the lower pressure loss coefficient increases the power block efficiency. The following data for the calculation of  $\Delta P$  is used; the pressure loss in hot side and cold sides of the heat exchanger is 2.5% (i.e.,  $\Delta P_{hh}/P_1$  and  $\Delta P_{hc}/P_2$ ) and pressure loss in precooler is 1% ( $\Delta P/P_1$ ). The maximum pressure loss coefficient is calculated based on different  $\theta$  values ranging from 0.15 to 0.35 for increasing compression ratio  $r_c$  as shown in Figure 4. It is noted that with increase of temperature increase due to solar energy,  $\Delta P$  also increases. For any particular value of  $\theta$  i.e for a fixed solar field design, with increase of compression ratio there pressure loss coefficient increases.

It is noted from figure 5 the power block efficiency increases as the maximum cycle temperature increases and for present case its becoming maximum at 1540 °C ; i.e., 55%. It is interesting to observe the influence of the variation of the average field density on its optical efficiency. It is noted

that the optical efficiency is in the range of 50%-70% based on the variation of field density 25%-75% [9]. The studies conducted [11] showed the optical efficiency decreases as the field density increases. Similar analysis is carried out based on the field density variation on the receiver efficiency and found that with increase of field density, the receiver efficiency also increases; i.e., with 25%- 70% field density the efficiency variation is 60%-95%.



**Figure 5.** Power block efficiency versus maximum cycle temperature

Based on the above analysis, similar plots are made by varying the receiver efficiency and keeping the optical efficiency for particular set values and after that varying the optical efficiency by keeping the particular set values of receiver efficiency. From Figure 6 it shows that with increase of power block efficiency which depends on  $\theta$ , overall efficiency of the system also increases and with optical efficiency of 70% maximum overall efficiency reached is around 15% at 35% power block efficiency.

Similar analysis as shown in Figure 7, were carried out based on the receiver efficiency variation from 50% to 95%. It is noted that the maximum overall efficiency achieved 95% receiver efficiency and 40% power block efficiency.

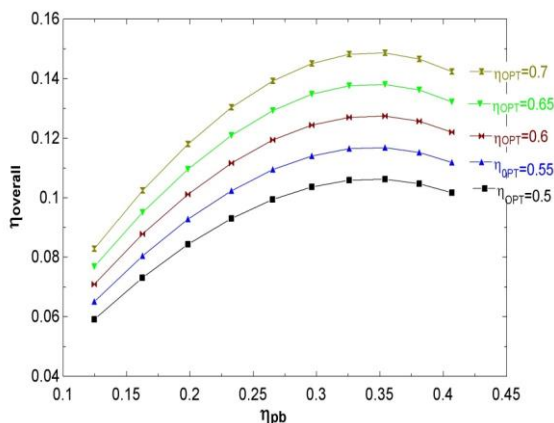

**Figure 6** Overall Efficiency versus power block efficiency by varying the optical efficiency

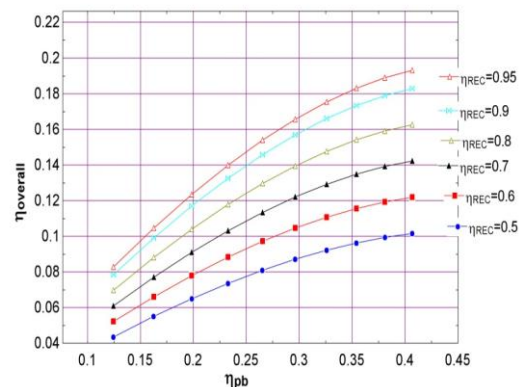

**Figure 7** Overall Efficiency versus Power Block Efficiency by varying the receiver efficiency

#### 4. Conclusions

Concentrating solar power technologies have shown a great potential which lead it to its commercial maturity for producing power in a scalable size. There are still lot of work is required to improve at different levels such as heliostats fields optimization in terms of optical performance, land use, layout to enhance efficiency and minimize losses. Thermodynamic analysis were carried out considering optical efficiency based on field density of a beam down solar tower concentrating receiver system integrated with a closed loop Bryton cycle operating with Helium as working fluid. Use of heat exchanger before the receiver system and the pressure loss coefficient equations were derived to determine the optimum compression ratio of compressor for maximum efficiency. The analysis is extended to considering optical efficiency of the solar concentrating receiver system by varying the optical efficiency from 50 – 70% and receiver efficiency from 50 – 95% and overall efficiency of the system is determined which could produce around 20%. There is enough potential in solar tower concept with increase of new optical technologies and efficiency of the overall system can be increased to great extent.

#### Nomenclature:

$m$ =adiabatic index.

$Q$ =Amount of heat added in solar receiver (KJ/Kg)

$r$ = Pressure ratio

$T$ = Temperature (K)

$W$ =Specific work (kJ/Kg)

$P_t$ =Total power arriving to the aperture plane of the Receiver concentrator

$P_{rad}$  = Amount of power lost by re-radiation from the cavity

$P_{nc}$ = Power lost by natural convection

$P_{abs}$  =Power absorbed by the RC surface

$\alpha$ = Absorptance of the receiver

$P_{ap}$ =Power intercepted by the RC aperture

Greek letters;

$\eta$  = Efficiency

$\theta$  = Ratio of Solar lower to higher temperature in cycle

$\varepsilon$  = Effectiveness of heat exchanger

$\gamma$  = Ratio of Specific Heats

$\psi$  = Hydrodynamic Resistance Coefficient

$\Delta P$  = Pressure loss Coefficient.

Subscripts:

C = Compressor

t = Turbine

s = Solar Receiver

hc = Heat Exchanger cold gas stream

hh = Heat exchanger hot gas stream

m = mechanical

pc =precooler

pb = power block

rec = receiver

rej = rejected from CPC

abs = absorbed

overall = Entire system

Max= maximum

eff= effective

### Acknowledgments

The research presented is performed within the framework of the Erasmus Mundus Joint Doctorate SELECT+ program 'Environomical Pathways for Sustainable Energy Systems' and funded with support from the Education, Audiovisual, and Culture Executive Agency (EACEA) of the European Commission. This publication reflects the views only of the author(s), and the Commission cannot be held responsible for any use, which may be made of the information contained therein.

### 5. References

- [1] Akiba Segal, 2016, *Renewable Energy and Environmental Sustainability*, 1 1
- [2] Omar Behar, Abdullah Khellaf, Kamal Mohammedi, 2013, *Renewable and sustainable energy reviews*, 23 12-39
- [3] Akiba Segal., Michael Epstein, 2003, *Journal of Solar Energy Engineering*, **75**, 503–510.
- [4] P Gandhidasan, 1993, *Energy Conversation Management*, **34**, 657-661.
- [5] Manuel Rumero., Reiner Buck., James E Pacheco, 2002, *Journal of Solar Energy Engineering*, **124**, 98-108.
- [6] Peter Schwarzbozl., Reiner Buck., Chemi Sugarmen., Arik Ring., Ma Jesus., Marcos Crespo., Peter Altwegg, Juan Enrile, 2005, *Journal of Solar Energy Engineering*, **80** 1231-1240
- [7] James Spelling, Bjorn Laumert, 2014, *Journal of Engineering for Gas Turbines and Power*, **137**, 031801
- [8] Balling, L., 2010, *Modern Power Systems* **30(12)** 61–65
- [9] Coelho Bruno, Schwarzbozl Peter, Oliveira Armando, Mendes Adelio. 2012, *Solar Energy* **86** 2912–22
- [10] Xu Chao, Wang Zhifeng, Li Xin, Sun Feihu, 2011, *Applied Thermal Engineering*, **31** 3904–13.
- [11] A'lvarez JD, Guzma'n JL, Yebra LJ, Berenguel M, 2009. *Modelling Practice and theory*, **17** 664-79.