

Dynamic thermal-hydraulic modelling of the EU DEMO WCLL breeding blanket cooling loops

Original

Dynamic thermal-hydraulic modelling of the EU DEMO WCLL breeding blanket cooling loops / Froio, Antonio; Casella, F.; Cismondi, F.; Del Nevo, A.; Savoldi, Laura; Zanino, Roberto. - In: FUSION ENGINEERING AND DESIGN. - ISSN 0920-3796. - STAMPA. - 124:(2017), pp. 887-891. [10.1016/j.fusengdes.2017.01.062]

Availability:

This version is available at: 11583/2674047 since: 2018-01-24T10:00:52Z

Publisher:

Elsevier Ltd

Published

DOI:10.1016/j.fusengdes.2017.01.062

Terms of use:

This article is made available under terms and conditions as specified in the corresponding bibliographic description in the repository

Publisher copyright

(Article begins on next page)

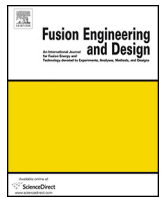

Dynamic thermal-hydraulic modelling of the EU DEMO WCLL breeding blanket cooling loops



A. Froio^a, F. Casella^b, F. Cismondi^c, A. Del Nevo^d, L. Savoldi^a, R. Zanino^{d,*}

^a NEMO Group, Dipartimento Energia, Politecnico di Torino, 10129 Torino, Italy, Italy

^b Dipartimento di Elettronica, Informazione e Bioingegneria, Politecnico di Milano, 20133 Milano, Italy

^c PPPT Department, EUROfusion Consortium, 85748 Garching bei München, Germany

^d ENEA CR Brasimone, 40032 Camugnano, BO, Italy

HIGHLIGHTS

- System-level thermal-hydraulic model of the WCLL Breeding Blanket cooling loop developed.
- Highly modularity thanks to the Modelica language.
- Simplified model able to simulate the whole WCLL cooling system in faster-than-realtime.
- Model benchmarked against CFD calculations.
- First application to steady-state nominal scenario.

ARTICLE INFO

Article history:

Received 30 September 2016

Received in revised form 9 January 2017

Accepted 19 January 2017

Available online 16 February 2017

Keywords:

DEMO

Breeding blanket

WCLL

Cooling circuit

Thermal-hydraulics

Modelling

ABSTRACT

A global thermal-hydraulic model of the EU DEMO tokamak, based on an object-oriented approach using the Modelica language, is currently under development at Politecnico di Torino. The first module of the global model will simulate the dynamics of the blanket cooling system and it will be able to investigate different coolant options and different cooling schemes, adapted to the different blanket systems currently under development in the Breeding Blanket project. Following the development of the module related to the Helium-Cooled Pebble Bed blanket, this paper presents the dynamic model of the Water-Cooled Lithium Lead (WCLL) blanket, designed at ENEA Brasimone, together with the first results obtained in steady-state conditions.

© 2017 The Authors. Published by Elsevier B.V. This is an open access article under the CC BY-NC-ND license (<http://creativecommons.org/licenses/by-nc-nd/4.0/>).

1. Introduction

The development of a conceptual design of the European Demonstration Fusion Power Reactor (EU DEMO) is one of the goals defined in the EU fusion roadmap Horizon 2020 [1]. Starting from the results obtained by ITER, this device will prove the feasibility of a closed fuel cycle, achieving tritium self-sufficiency, and the production of net electricity.

Within this framework, the EUROfusion Project Management Unit (PMU) is supporting the development of a global thermal-hydraulic model of the whole tokamak at Politecnico di Torino, aimed at the simulation of the cooling loops of the main in-vessel

components, including the ex-tokamak parts. The model shall be developed in a modular fashion, according to an object-oriented approach, and will eventually allow to perform fast parametric analyses of the whole tokamak cooling system.

The first module of the global model is devoted to the simulation of the Breeding Blanket (BB) cooling system, which in DEMO will be at the same time the core element of the power generation. The development of this module started in 2015, with the development of the model for the Helium-Cooled Pebble Bed (HCPB) BB concept [2]. In this paper we present the development and first application of the second part of the BB module, devoted to the modelling of the Water-Cooled Lithium-Lead (WCLL) BB concept.

* Corresponding author.

E-mail address: roberto.zanino@polito.it (R. Zanino).

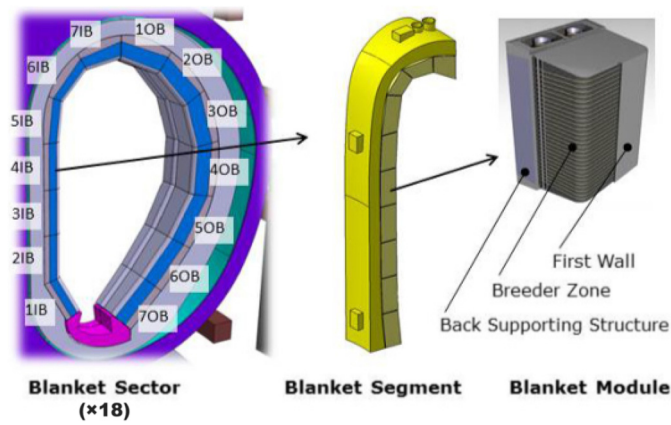

Fig. 1. Blanket segmentation, showing the numbering convention of the IB1-7 and OB1-7 BMs (reproduced from [5]).

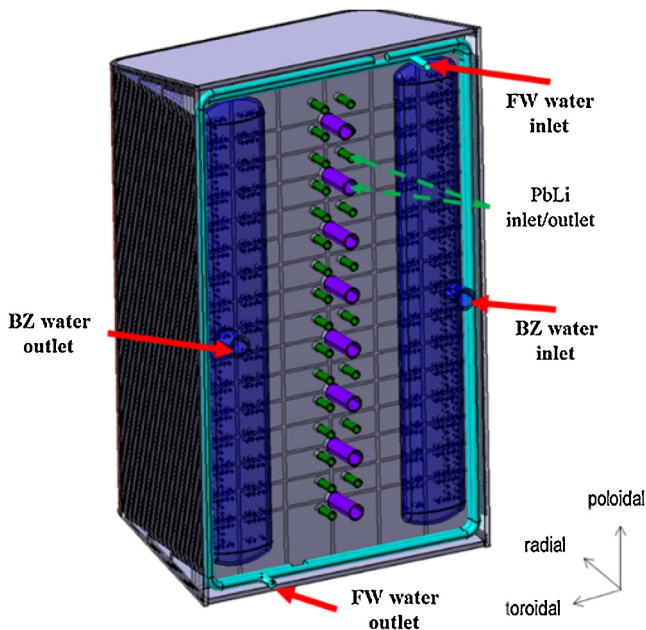

Fig. 2. CAD of the rear side of the WCLL OB4 BM, showing the coolant I/O manifolds.

2. WCLL cooling circuit

For the development of this model the 2015 design of the WCLL BB [3,4] has been considered. The tokamak is divided in 18 equal toroidal sectors: each sector is made of three identical Outboard (OB) and two identical Inboard (IB) blanket segments; each segment contains 7 Breeding Modules (BMs) [5], see Fig. 1. Each BM, shown in Fig. 2, comprises a portion of the First Wall (FW) and a Breeding Zone (BZ), containing the liquid (PbLi) breeder material. The cooling circuit is split when entering the vessel, with two different sets of manifolds delivering the water coolant to the FW and the BZ in parallel, as visible in Fig. 2.

3. Model description

A sketch of the cooling circuit model is reported in Fig. 3. The FW loop, composed by rectangular cooling channels immersed in the FW solid structure, is further split in two parts, with the water coolant running in one direction in half of the channels and in counterflow in the other half, as shown in Fig. 4; this loop is also used to cool the upper and lower walls of the BM. The solid part of the FW

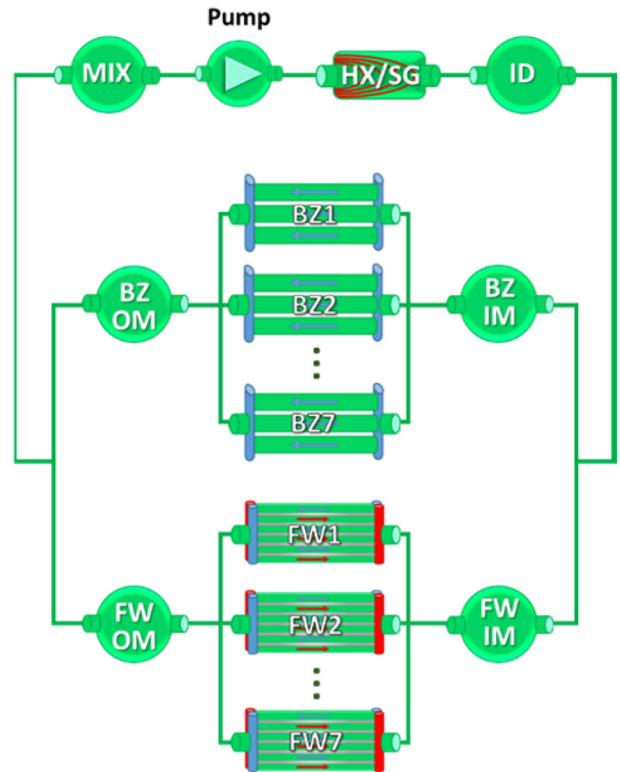

Fig. 3. Schematic of the WCLL cooling circuit model (FW#: First Wall object; BZ#: Breeding Zone object; IM: Inlet Manifold; OM: Outlet Manifold; ID: Inlet Distributor; MIX: Mixer; HX/SG: Heat eXchanger/Steam Generator).

is included in the FW cooling circuit model by treating the channel walls as 1D objects in the flow direction, see [2] for details.

The BZ part, whose model is shown in Fig. 5, is cooled by circular double-wall tubes, which are in contact with the PbLi flowing in the free space on their outer side. The tubes are arranged in a modular layout, with a set of elementary cells of 21 tubes (shown in Fig. 6) ideally stacked in the poloidal direction, with inlet orifices to control the mass flow rate distribution.

The primary heat sink is the heat exchanger (HX), which can be a steam generator (SG), if the primary heat is to be directly used to produce electricity, or a water/molten salts HX, if an intermediate energy storage loop is to be used. Finally, the operational pressure and the range of water temperature are the same as in the primary loops of pressurised water reactors (*i.e.* $p = 15.5$ MPa, T between 285 and 325 °C).

The model is written using Modelica, which is an object-oriented declarative modelling language aimed at convenient modelling of complex systems, see [2] and references therein. The model is 0D/1D, with the cooling channels modelled with a 1D finite volume approach, while the other components (such as e.g. valves) are 0D; also the manifolds are treated as 0D objects, for the time being.

For the HX/SG a 0D ideal HX model is adopted, *i.e.* imposing that the outlet temperature is always at the nominal value (285 °C), independently of the inlet temperature value. The secondary circuit is not modelled for the time being. In all the components, the time-dependent form of conservation of mass, energy and, for the 1D models only, momentum, is enforced (see [2] for details on the solved equations).

Within the model, each channel can be different from all the others, both in terms of geometry (e.g. cross section) and load, making the code an ideal tool to perform parametric analyses aimed e.g. at the optimization of the coolant distribution, without the need

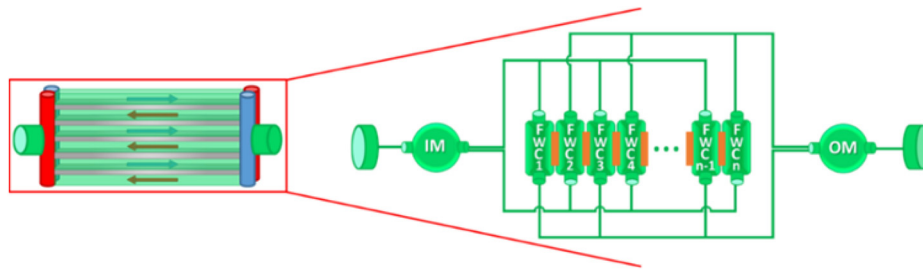

Fig. 4. Schematic of the generic FW# object (FWC#: First Wall Channel object; IM: Inlet Manifold; OM: Outlet Manifold). The inlet and outlet fluid connectors are represented by vertical disks at the beginning and at the end of the model.

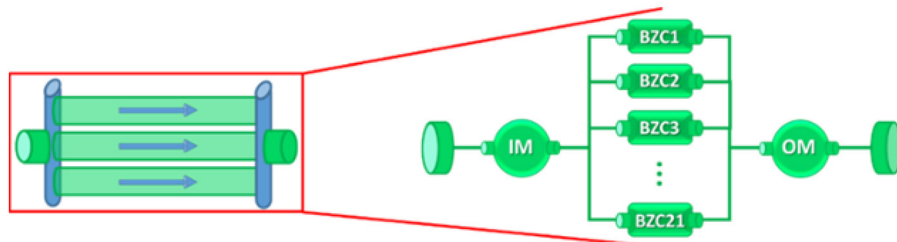

Fig. 5. Schematic of the generic BZ# object (BZC#: Breeding Zone Channel object; IM: Inlet Manifold; OM: Outlet Manifold).

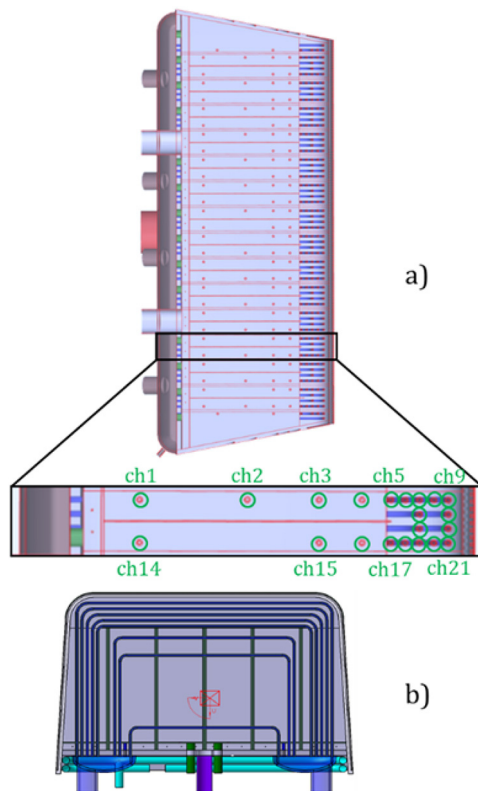

Fig. 6. Radial-poloidal (a) and radial-toroidal (b) cut of OB4, showing the details of the elementary cell in the inset; the 21 channels are circled in green in the inset (adapted from [3]). (For interpretation of the references to colour in this figure legend, the reader is referred to the web version of this article.)

for time-demanding detailed Computational Fluid Dynamics (CFD) calculations.

In view of the very large number of channels needed to model the whole WCLL system, some simplifying assumptions have to be made. Hence, a new fully standard-compliant Modelica library has been developed to compute the fluid-dynamics of the coolant, sim-

plifying the computation of the fluid properties. In particular, the water is assumed to be always liquid (single phase), with specific heat, density and the derivative of the internal energy with respect to the temperature at constant pressure linearly dependent on the temperature; these assumptions allow to perform very fast simulations, while still being acceptable if the coolant stays inside or close to the operational limits, with the errors on the above-mentioned variables always below 3.5 % and below 2 % on average. In addition to that, the pressure drop characteristic of each channel is linearized around the operating point (*i.e.* the pressure drop depends linearly on the mass flow rate). Finally, the heat transfer coefficient between the fluid and the solid structures in the FW, as well as the solid specific heat and density, are considered constant.

In the case of off-normal transients, however, the assumptions on the thermophysical properties of the coolant may not be valid anymore and the model cannot be used; for this reason, a second version has been developed, with a detailed description of the thermophysical properties of the coolant and simplifying geometrical assumptions to maintain the code speed, which can be used *e.g.* for transient analyses (*e.g.* in-vessel LOCAs).

4. A simple application of the model

In order to check its capabilities, the code has been used to simulate a simple scenario. Since the data on the ex-vessel components are not available yet (as their design is still ongoing), the loop is not closed and only the in-vessel components (*i.e.* channels and manifolds) are simulated. Hence, as boundary conditions, the nominal values of pressure and temperature are imposed at the inlet, while at the outlet the pressure is imposed according to the expected pressure drop of 7.7 kPa (OB modules) or 7.3 kPa (IB modules) [3]. Moreover, the orifices at the inlet of the channels are set in order to have the mass flow rate uniformly distributed among the channels.

Following a similar approach to what was done in [2] for the HCPB, in order to check if all the points in the BZ volume are adequately cooled, *i.e.* if all the cooling channels inside one elementary cell reach (almost) the same outlet temperature value, a steady-state heat load is imposed (equal to the nominal values reported in [3]). The power is generated in the PbLi according to an exponential law peaked on the plasma side, which is considered reasonable

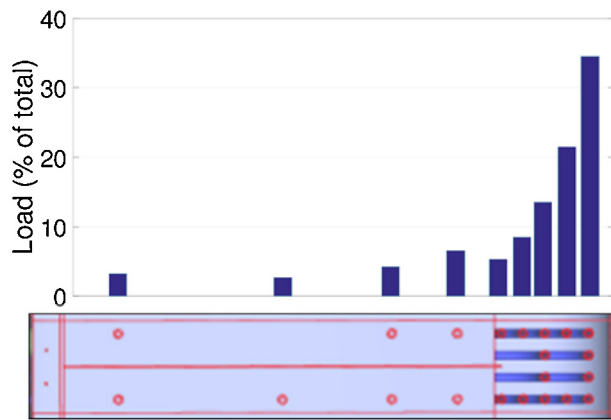

Fig. 7. Power distribution in one elementary cell.

Table 1

Comparison among the outlet temperatures computed by the model and those obtained by CFD.

Channel	System-level model outlet temperature [°C]	CFD model outlet temperature [°C] [3]
1-14	294.8	290.4
2	292.0	301.2
3-15	296.3	306.6
4-16	302.9	313.3
5-17	299.4	318.0
6-18	307.5	315.2
7-10-12-19	303.2	320.1
8-20	337.9	325.7
9-11-13-21	328.5	335.6

distribution among the channels, and reflects with acceptable accuracy the results obtained in [3] using CFD, see Table 1, qualitatively confirming the validity of the model, particularly if considering that in the CFD model the detailed temperature distribution in the PbLi was taken into account, while in the present work a simple exponential power distribution is assumed.

In order to ensure adequate cooling of all the points of the BZ and to have (at least in nominal conditions) the same outlet temperature in all the channels, it is hence needed to tune the mass flow into the channels, using the orifices at the channel inlets. This can be done applying the model to perform a parametric analysis varying the respective pressure drops in a suitable range, which might be prohibitively expensive if performed through CFD.

5. Conclusions

A system-level transient model of the EU DEMO WCLL BB cooling system has been developed. Being written using the Modelica language, it is highly modular and can be easily adapted to the ongoing design of the BB.

Thanks to its speed, this tool can be very helpful in this phase of the design, to rapidly look at the effect of the variation of a parameter, without the need for computationally expensive CFD calculations.

The model has been implemented as a new Modelica library, containing a simplified definition of the coolant thermophysical properties and all the objects needed to model the cooling loop; this library has been specifically written for the model to be extremely fast in simulating the whole cooling system, while still keeping an acceptable accuracy.

The newly developed tool has been tested in a simple steady-state case to check its validity and performances, with the aim of looking at the mass flow rate unbalances among the BZ cooling channels; as expected, the results showed that the flow must be optimized in order to better redistribute the temperature increase in the channels and avoid hot-spots with temperatures above the saturation value.

Acknowledgments

This work has been carried out within the framework of the EUROfusion Consortium and has received funding from the Euratom research and training programme 2014-2018 under grant agreement No 633053. The views and opinions expressed herein do not necessarily reflect those of the European Commission.

References

- [1] F. Romanelli, P. Barabaschi, D. Borba, G. Federici, L. Horton, R. Neu, D. Stork, H. Zohm, Fusion Electricity—A Roadmap to the Realisation of Fusion Energy, European Fusion Development Agreement (EFDA), 2012, ISBN

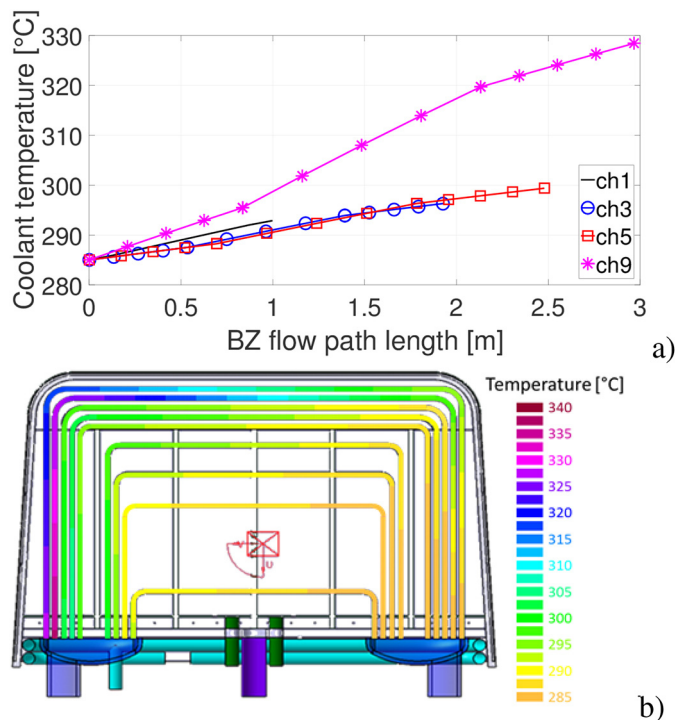

Fig. 8. 1D profile along the channel (a) and distribution in the radial-toroidal plane (b) of the coolant temperature in four selected cooling channels out of the 21 of an elementary unit of the OB4 module.

as the power generated is proportional to the neutron flux, that is assumed to follow an exponential law [3]. As in the model each channel is considered responsible for the cooling of the volume of PbLi around it, and these volumes turn out to be different because of the disposition of the channels, the resulting distribution of the power deposited in each channel, reported in Fig. 7, is not exponential: channels further away from the plasma, but taking care of a larger volume of PbLi, end up extracting more power than channels closer to the plasma.

Fig. 8 reports the temperature distribution for four selected channels out of the 21 of one elementary unit of the OB4 (equatorial) module; a similar situation is found in all the IB and OB BMs.

The temperature increase is different from channel to channel, with some of them reaching a temperature above the maximum design value of 325 °C [4]. This result was expected, since the mass flow rate distribution was not regulated based on the heat load

- 978-3-00-040720-8T. [Online]. Available: <https://www.euro-fusion.org/wpcms/wp-content/uploads/2013/01/JG12.356-web.pdf>.
- [2] A. Froio, C. Bachmann, F. Cismondi, L. Savoldi, R. Zanino, Dynamic thermal-hydraulic modelling of the EU DEMO HCPB breeding blanket cooling loops, *Prog. Nucl. Energy* 93 (2016) 116–132.
- [3] A. Del Nevo, E. Martelli, M. Oron-Carl, Design Description Document 2015 for WCLL (update of DDD 2014), EFDA.D.2MU9XC, 2016.
- [4] A. Del Nevo, P. Agostini, P. Arena, G. Bongiovi, G. Caruso, G. Di Gironimo, P.A. Di Maio, M. Eboli, R. Giammusso, F. Giannetti, et al., WCLL breeding blanket design and integration for DEMO 2015: status and perspectives, *Fusion Eng. Des.* 124 (2016) 682–686.
- [5] L.V. Boccaccini, G. Aiello, J. Aubert, C. Bachmann, T. Barrett, A. Del Nevo, D. Demange, L. Forest, F.A. Hernández González, P. Norajitra, et al., Objectives and status of EUROfusion DEMO blanket studies, *Fusion Eng. Des.* 109–111 (2016) 1199–1206 (Part B).