

Venturi flow meter and Electrical Capacitance Probe in a horizontal two-phase flow

Original

Venturi flow meter and Electrical Capacitance Probe in a horizontal two-phase flow / Monni, Grazia; Caramello, Marco; DE SALVE, Mario; Panella, Bruno. - In: JOURNAL OF PHYSICS. CONFERENCE SERIES. - ISSN 1742-6588. - 665:1(2015), pp. 400-408. [10.1088/1742-6596/655/1/012033]

Availability:

This version is available at: 11583/2664046 since: 2017-01-27T15:17:34Z

Publisher:

IOP PUBLISHING

Published

DOI:10.1088/1742-6596/655/1/012033

Terms of use:

This article is made available under terms and conditions as specified in the corresponding bibliographic description in the repository

Publisher copyright

(Article begins on next page)

Venturi flow meter and Electrical Capacitance Probe in a horizontal two-phase flow

This content has been downloaded from IOPscience. Please scroll down to see the full text.

2015 J. Phys.: Conf. Ser. 655 012033

(<http://iopscience.iop.org/1742-6596/655/1/012033>)

View [the table of contents for this issue](#), or go to the [journal homepage](#) for more

Download details:

IP Address: 130.192.21.156

This content was downloaded on 27/01/2017 at 13:57

Please note that [terms and conditions apply](#).

You may also be interested in:

[Generation of Submicron Bubbles using Venturi Tube Method](#)

I G P A E Wiraputra, D Edikresnha, M M Munir et al.

[POD study of aerated cavitation in a venturi nozzle](#)

P Tomov, A Danlos, S Khelladi et al.

[Series Supply of Cryogenic Venturi Flowmeters for the ITER Project](#)

J André, J M Poncet, E Ercolani et al.

[CFD analysis of flow through Venturi tube and its discharge coefficient](#)

A Tukimin, M Zuber and K A Ahmad

[Two-Phase flow instrumentation for nuclear accidents simulation](#)

G Monni, M De Salve and B Panella

[Measurements of Lubricant Film Thickness in Reciprocating Piston Cylinder Assemblies and Engines](#)

P Dellis and C Arcoumanis

[Modification to mass flow rate correlation in oil--water two-phase flow](#)

Chao Tan and Feng Dong

[Quantum fluctuations in the matter-gravity system](#)

G Venturi

[Using jets of air to teach fluid dynamics](#)

T López-Arias, L M Gratton, G Zendri et al.

Venturi flow meter and Electrical Capacitance Probe in a horizontal two-phase flow

G Monni, M Caramello, M De Salve and B Panella

Energy Department, Politecnico di Torino, Corso Duca degli Abruzzi, 24, 10129

E-mail: marco.caramello@polito.it

Abstract. The paper presents the results obtained with a spool piece (SP) made of a Venturi flow meter (VMF) and an Electrical Capacitance Probe (ECP) in stratified two-phase flow. The objective is to determine the relationship between the test measurements and the physical characteristics of the flow such as superficial velocities, density and void fraction. The outputs of the ECP are electrical signals proportional to the void fraction between the electrodes; the parameters measured by the VFM are the total and the irreversible pressure losses of the two-phase mixture. The fluids are air and demineralized water at ambient conditions. The flow rates are in the range of 0,065-0,099 kg/s for air and 0- 0,039 kg/s (0-140 l/h) for water. The flow patterns recognized during the experiments are stratified, dispersed and annular flow. The presence of the VFM plays an important role on the alteration of the flow pattern due to wall flow detachment phenomena. The signals of differential pressure of the VFM in horizontal configuration are strongly dependent on the superficial velocities and on the flow pattern because of a lower symmetry of the flow with respect to the vertical configuration.

1. Introduction

In the framework of integral test facilities for the thermal-hydraulic simulation of nuclear reactors, with particular emphasis to small modular reactors, there is a large interest in the characterization of the behaviour of the system in case of design basis accidents. As an example, the simulation of LOCA accidents can be performed by means of straight horizontal pipes equipped with fast opening valves or rupture disks to connect the external environment with the primary system. Such pipes are also used to locate the proper instrumentation to evaluate the thermal- hydraulic quantities of the flow before the section of the rupture. The final goal of the instrumentation is to estimate the flow rate of the liquid and vapour phases and the energy released from the rupture with time, so to retrieve the behaviour of mass inventory and internal energy inside the primary system during the accidental transient. The flow rates of the phases through the rupture cannot be measured in a direct manner because of the complexity of the flow. It is therefore necessary to retrieve the value of the flow rates on the basis of the characteristic parameters of the two-phase flow, such as the void fraction, the flow pattern, the density and the superficial velocities. These quantities are usually measured by means of a special instrumentation called spool piece (SP). A spool piece is a combination of two or more instruments whose electrical signals are proportional to the characteristic parameters of the two-phase flow. Several instruments can be found in a SP, such as Venturi flow meters (VFM) [1], electrical capacitance probes (ECP) [2], drag disks [3], turbines [3], wire mesh sensors [4].

The correct interpretation of the signals of the instruments requires the development of models able to describe the two-phase fluid-dynamics in the test section, the working principle of the instrument together with the relationships between the electrical signals and the physical parameters of the flow (liquid and gas flow rates, void fraction). The validation of the measurements is often done by comparing the prediction of the instruments with the estimation of theoretical models. The complete characterization of a spool piece for the estimation of the two-phase flow parameters implies the definition of the instruments belonging to the SP from the geometrical point of view, the configuration of the test section and the relationship between the electrical signals and the physical quantities. Other



important values to be estimated in order to complete the characterization of the flow are the absolute pressure, differential pressures along the test section and the temperature of the mixture. During the last years several SPs have been tested and characterized at Politecnico di Torino [5-7] by means of experimental facilities at low pressure using demineralized water and air in horizontal and vertical configuration, with a particular interest in the characterization of annular dispersed and stratified annular flows. In this paper the experimental results obtained with a SP consisting of a Venturi flow meter and an Electrical Capacitance Probe in horizontal configuration are presented. The Venturi flow meter has been widely used for the estimation of the mass flow rate in single phase flow because of its simplicity, the low cost and the low maintenance required. For these reasons, with the aim to characterize its behaviour in two-phase flow, the VFM has been studied by many authors both theoretically and experimentally [8-13]. The Electrical Capacitance Probe has the aim to estimate the void fraction of the fluid and the flow pattern. The working principle of the instrument is based on the fact that the phases constituting the two-phase mixture are characterized by different electrical properties, and that the measured response of the instrument is a function of the void to the fraction of the phases [14-16]. The specific ECP tested during the experimental campaign has been designed and produced by SIET Company.

2. Test facility

A picture of the experimental facility used for the characterization of the SP made of the Venturi flow meter and the Electrical Capacitance Probe is shown in figure 1. It consists of an air blower, the demineralized feedwater system, an air-water mixer, two quick closing valves, a calibrated orifice, an open discharge volume, additional instrumentation and the SP. The piping system is made of Plexiglas for the direct observation of the flow pattern. The internal diameter is 80 mm. The orifice is installed before the air-water mixer and it is used to estimate the air flow rate. It is characterized by a diameter of 65 mm and a minimum section diameter of 30,19 mm. The discharge coefficient has been evaluated according to the UNI standards and has a value of 0,605. The demineralized feedwater flow is imposed by means of two rotameters of different full-scale. The additional instrumentation consists of relative and absolute pressure transducers and K-type thermocouples along the experimental facility. The pressure transducers are installed on the calibrated orifice to estimate the gas flow rate and on the Venturi in order to measure both irreversible and total pressure drops.

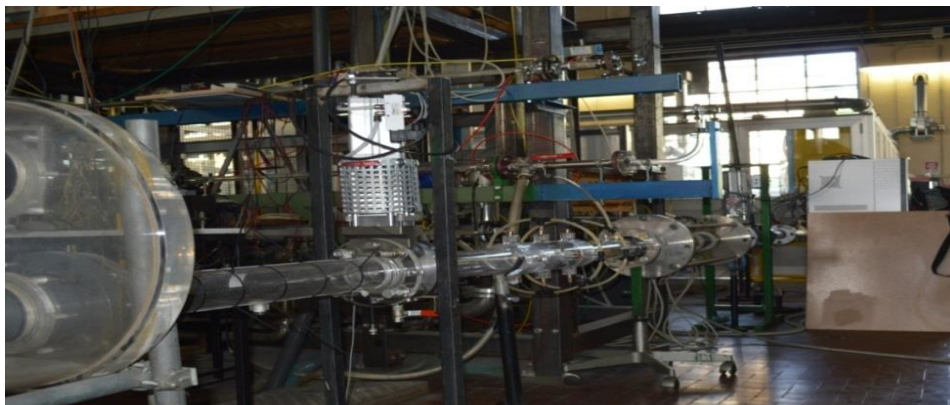

Figure 1. The experimental facility.

They are characterized by a linear or parabolic response in which the full scale, the output current (4-20) mA and the conversion resistance of the signal from current to voltage are taken into account. The calibration curves of the differential pressure transducers have been obtained by imposing known water heads on the instruments. The quick closing valves are used to measure the average void fraction in the test section. The estimation of the average void fraction has been done following two different procedures: a) the mass of water between the two quick closing valves is drained from the

bottom and measured by means of a weightier (for low void fraction value), b) a mass of water is injected in the intercepted region of the facility until a certain level on the cross section is obtained. From the knowledge of the total volume of the test section the intercepted mass of water and the void fraction (for high void fraction value) can be evaluated. Figure 2 shows a picture of the Venturi flow meter. It is a symmetrical short-type Venturi designed according to ISO 5167-4: 2003 standards. The use of a short-type instrument implies a reduction of the manufacturing costs even though the pressure losses of the instruments are higher compared to the ones of a standard Venturi because of flow detachment phenomena. The symmetrical configuration is an obliged choice if a flow reversal is expected. The geometrical parameters of the instrument are reported in table 1. The conical convergent section is $L=2.7*(D-d)=108$ mm long.

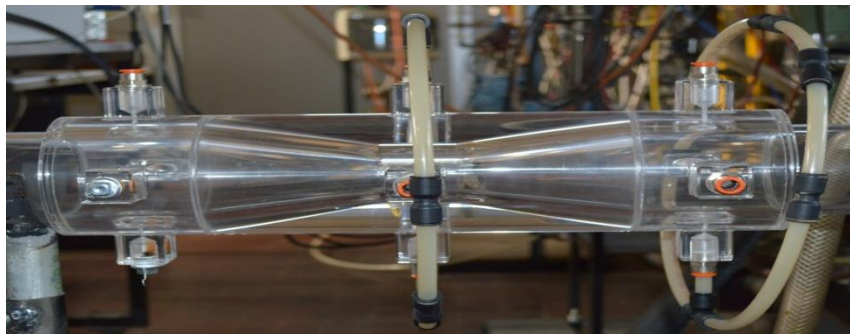

Figure 2. The Venturi flow meter.

Table 1. VFM geometrical data

Parameter	Value	
Diameter	80	mm
Throat diameter	40	mm
Angle	21	°
Total length	340	mm

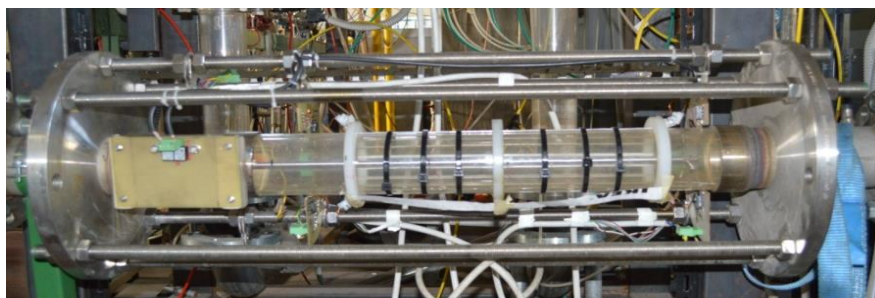

Figure 3. The Electrical Capacitance Probe.

Figure 3 shows a picture of the ECP. It is constituted by 9 linear electrodes (length of 400 mm and width of 5 mm) set on the external side of the Plexiglas pipe and a central electrode in the middle of the cross section. Figure 4 shows the electrodes position in the horizontal test section set up.

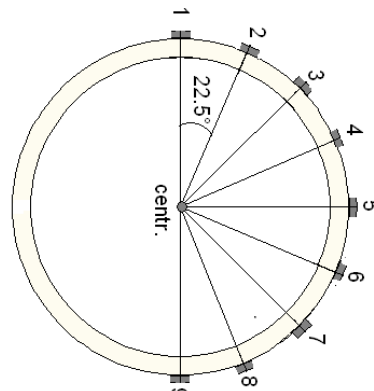

Figure 4. ECP electrodes configuration in experimental horizontal test section set up.

The peripheral electrodes are welded on both sides to the measurement chain, while the central electrode is welded only on one side. The distance between the sockets to which the electrodes are welded is sufficient to reduce the presence of parasitic currents. The geometrical parameters of the ECP and the maximum working conditions are reported in table 2.

Table 2. ECP characteristics

Parameter	Value
Diameter	80 mm
Length	600 mm
Wall thickness	5 mm
Maximum pressure	0.2 Mpa
Maximum temperature	60 °C
Angular distance between the electrodes	22,5°

The input/output electrical signals of the ECP are managed by LabView environment. A NI USB-6259 device is used both as input provider for the electrodes and output receiver. The input signal is sinusoidal with a frequency of 25 kHz and amplitude of 5 Vpp. The sequence of measurement is performed by exciting one electrode at a time and reading the output of the others receiving electrodes. The couple of exciting/receiving electrodes is uniquely defined by a code number. The sampling frequency of the ECP is 250 kHz.

A complete description of the theory of the ECP has been previously presented by the authors here [17]. The working principle is based on the different values of electrical conductivities and relative permittivities of liquid water and air. The RMS value of the voltage drop between an input electrode i and a receiving electrode j when a single phase is present in the test section is proportional to the electrical properties of the medium, its thermodynamic conditions and the angular distance between the electrodes (see equations 1 and 2 for liquid water and air respectively). The same couple of input and receiving electrodes in the presence of a two-phase mixture experiences a voltage drop (V in equation 3) which depends on the thermodynamic conditions, the distance and the electrical properties of the mixture which are dependent on the volume occupied by each phase between the two electrodes. By defining a suitable normalization of the signal in two-phase flow as the one proposed in equation 3 it is possible to correlate the signal of the ECP with the void fraction of the mixture between the electrodes.

$$V_{L,i,j}(T, \theta) = V_L(T, \theta) \quad (1)$$

$$V_{G,i,j}(T, \theta) = V_G(T, \theta) \quad (2)$$

$$V_{i,j}^*(\alpha, \theta, T) = \frac{V_L - V}{V_L - V_G} \quad (3)$$

3. Test procedure and experimental matrix

The test procedure that has been adopted for the experimental activity consists of the following steps:

1. the velocity of the blower and the water flow rate are imposed,
2. once a steady state condition is established, the measures from the calibrated orifice (gas flow rate), the VFM (differential pressures) and the ECP (electrical response) are acquired for a period of 30 seconds, in order to gain the information of RMS and standard deviation,
3. the quick closing valves are closed and both the blower and feedwater system are turned off,
4. the mass of water intercepted by the valves is drained from the system and measured by means of the weight measurement technique.

At the beginning of each session the single phase response of the instruments both for water and air are measured. These values are used in the post-processing of the results to normalize the signals of the ECP. For the present experimental campaign, the range of velocities obtained is between 11 and 18 m/s for air and 0,8 e 8 mm/s for water. The resulting flow patterns are stratified and annular stratified. For the same couple of flow rates of the liquid and gas phases two separate tests have been carried out in order to assess the repeatability of the measurements.

4. Results and discussion

The measurements and the characterization of the Venturi flow meter and the Electrical Capacitance Probe are assessed in the present chapter. Figure 5 shows the experimental relationship between the void fraction and the flow quality for the two experimental sets. The reproducibility of the results is considered satisfactory: the data dispersion is considered to be caused by different entrainment phenomena and the effect of ambient pressure and temperature, that are not easily reproducible.

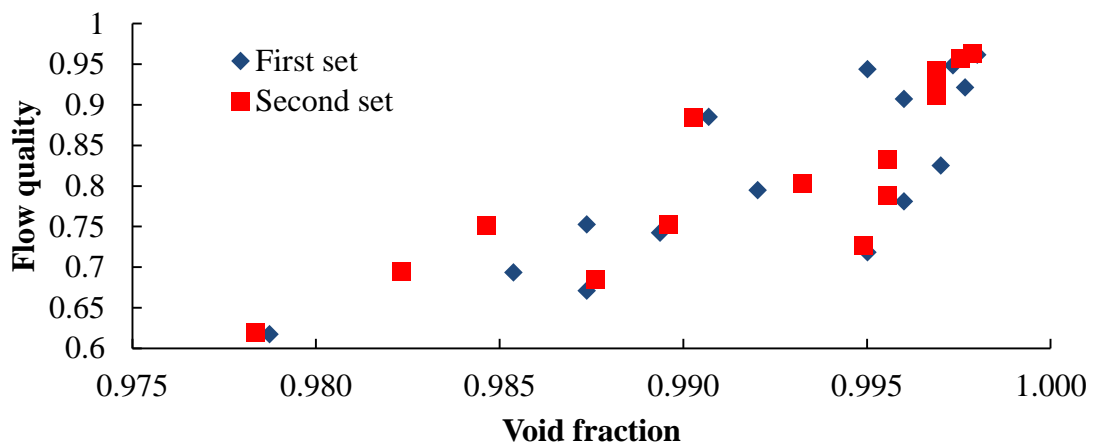

Figure 5. Flow quality as a function of the void fraction.

4.1. Characterization of the Venturi flow meter

Figure 6 shows the dependency between the measured pressure loss inside the VFM and the total flow rate. Three curves, characteristic of the three frequencies of the blower can be observed.

In the tested range the effect of variation of the gas velocity has a greater influence with respect to the liquid phase on the pressure loss inside the VFM. From the values of experimental pressure loss, both

in single-phase and two-phase flow, the relationship between the two-phase multiplier Φ_g^2 and the Lockhart-Martinelli parameter χ , defined as in equation 4, has been derived (figure 7).

$$\chi = \frac{(1-x)}{x} \left(\frac{\rho_g}{\rho_l} \right)^{0.5} \quad (4)$$

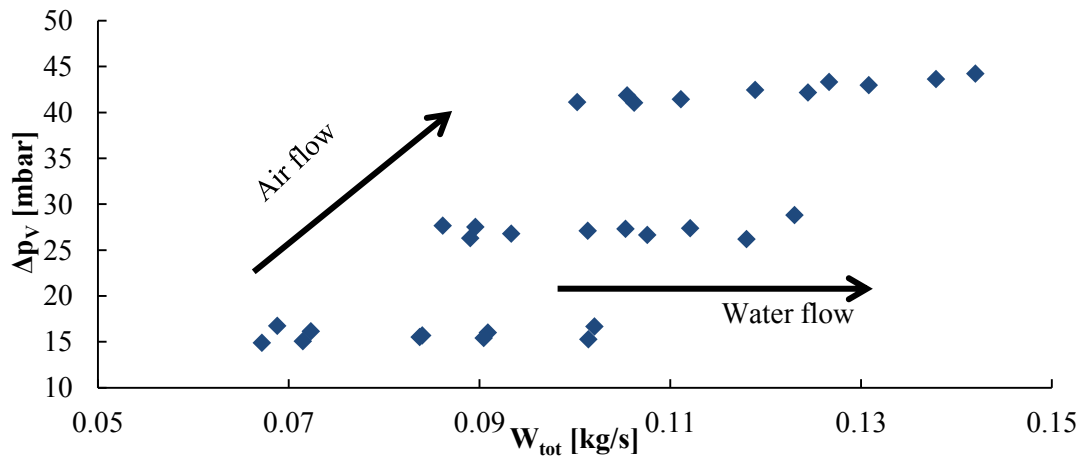

Figure 6. VFM pressure loss vs total flow rate.

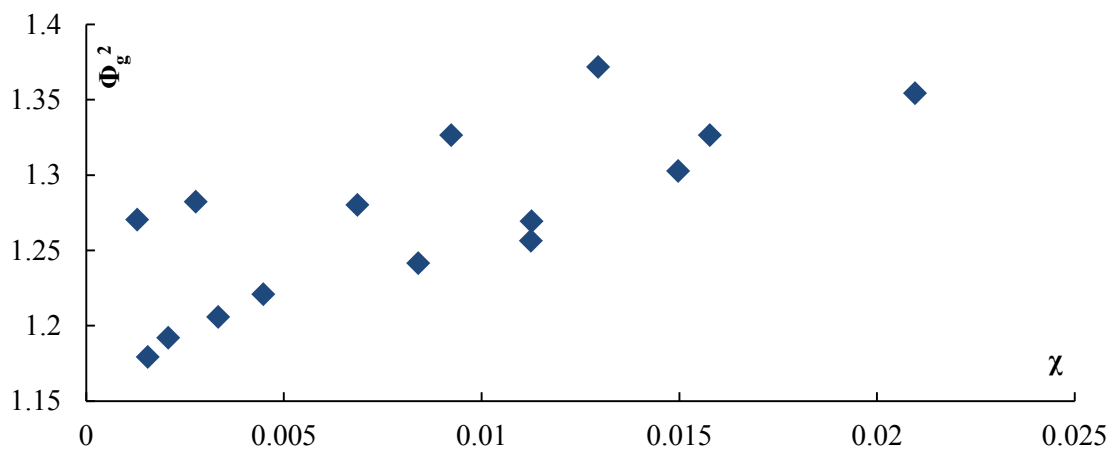

Figure 7. Experimental two-phase multiplier vs Lockhart-Martinelli parameter.

Another important measure obtained from the VFM is the irreversible pressure loss. The irreversible pressure loss shows an higher sensibility to the variation of liquid flow rate with respect to the standard VFM pressure loss (figure 8), and it is particularly influenced by the flow pattern. Three characteristic curves can be observed in figure 8: considering a fixed value of total mass flow rate higher pressure losses are measured in the presence of an higher air flow rate. By analysing the experimental results related to the irreversible pressure losses we found that they are strongly dependent on the density of the gas phase and on the superficial velocities of the phases (j_l, j_g). An empirical correlation has been derived for the estimation of the irreversible pressure loss through the VFM on the basis of the characteristic quantities of the two-phase flow (equation 5).

$$\Delta P_{irr} = 0,2705 (\rho_g J_g^{1,91}) \left(\frac{J_l}{J_g} \right)^{0,13} \quad (5)$$

The accuracy of the relationship in equation 5 with respect to the experimental data is of the order of 12%. In order to reduce the error the dependency of the correlation on the typology of the flow pattern has to be considered.

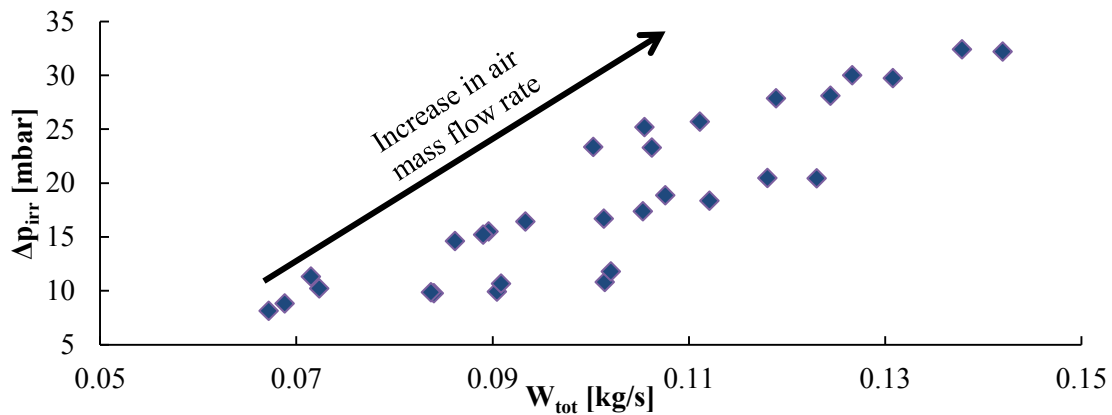

Figure 8. VFM irreversible pressure loss vs total flow rate.

4.2. Characterization of the electrical capacitance probe

Figure 9 shows the behaviour of the normalized signals V_{ij}^* as a function of the position of the electrodes, considering as input electrode i the number 1 in the upper part for the figures on the left side and the number 9 in the bottom part for the figures on the right side. The curves are expressed by using the experimental value of the void fraction as parameter.

Test section void fractions between 0,978 – 0,985 are typical of tick film annular flow regimes. The lower electrode shows a typical response of an annular stratified flow pattern.

In Fig. 9 the different dependency on the void fraction between the two chosen electrodes can be observed. The major contribution to this difference is expected to be the stratification of the liquid phase at the bottom of the cross section, which is clearly visible on the electrode 9. As the velocity of the gas phase increases entrainment phenomena of liquid droplets in the gas phase are more evident and this explains an increase of the dimensionless voltage drop of the electrode 9 as the void fraction increases.

In all of the cases considered in figure 9 an increase in the measured void fraction inside the test section causes a general increase in the output signal of the ECP, leading to the values of the full air case. This is more evident when the input signal is transmitted from electrode 9 which is always covered by a water level characterized by a smaller thickness as the void fraction increases.

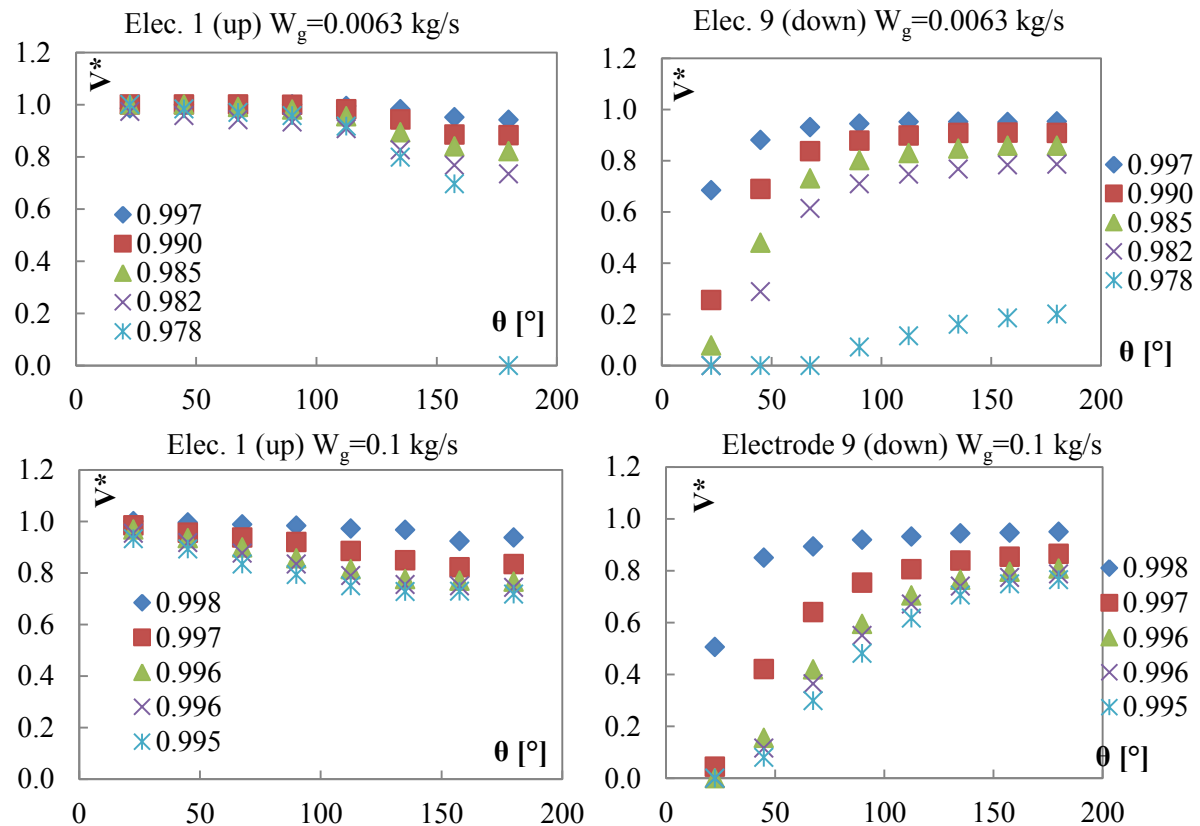

Figure 9. Dimensionless voltage drop for electrodes 1 and 9.

Figure 10 shows the dependency on the void fraction for the electrodes at the minimum angular distance of 22.5° where the electrical signal is maximum for every local void fraction.

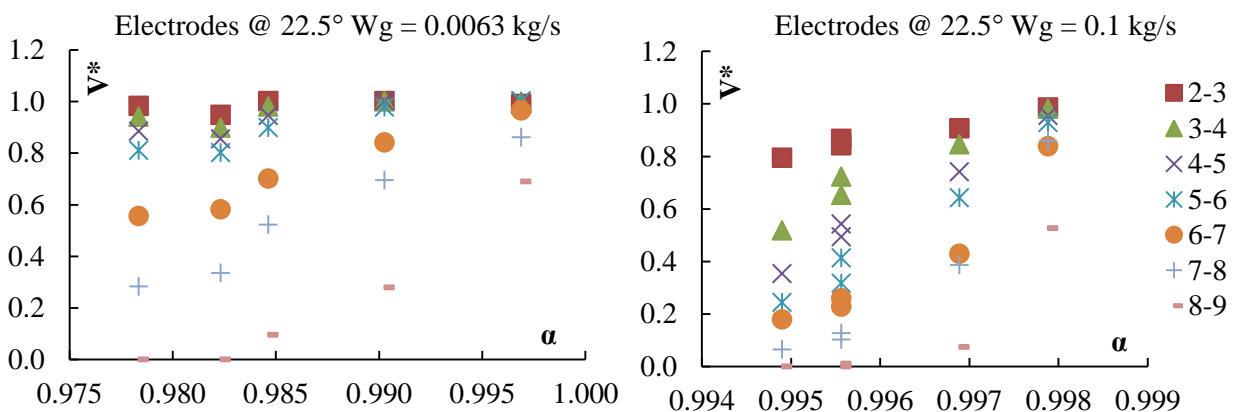

Figure 10. Dependency of the neighbouring electrodes on the void fraction.

The combination of the electrodes 2-3 is located in the upper part of the cross section. For low values of flow rates the behaviour of the signal is independent of the value of the void fraction since the flow pattern is stratified. On the other hand, the electrodes at the bottom of the cross section are largely influenced since they are able to experience the variation of thickness of the liquid film as the average

void fraction on the cross section changes. For the couple of electrodes 8-9 figure 10 shows the values of void fraction after which electrode 8 becomes uncovered by the water level (between the second and the third value of experimental void fraction). Figure 11 shows the same results of figure 10 with reference to the central electrode. The signal of the central electrode has a linear behaviour as a function of the void fraction, whose slope depends on the position of the external electrodes on the cross section. As in figure 10, an higher variation in the signal is recorded for the couples lying at the bottom of the cross section.

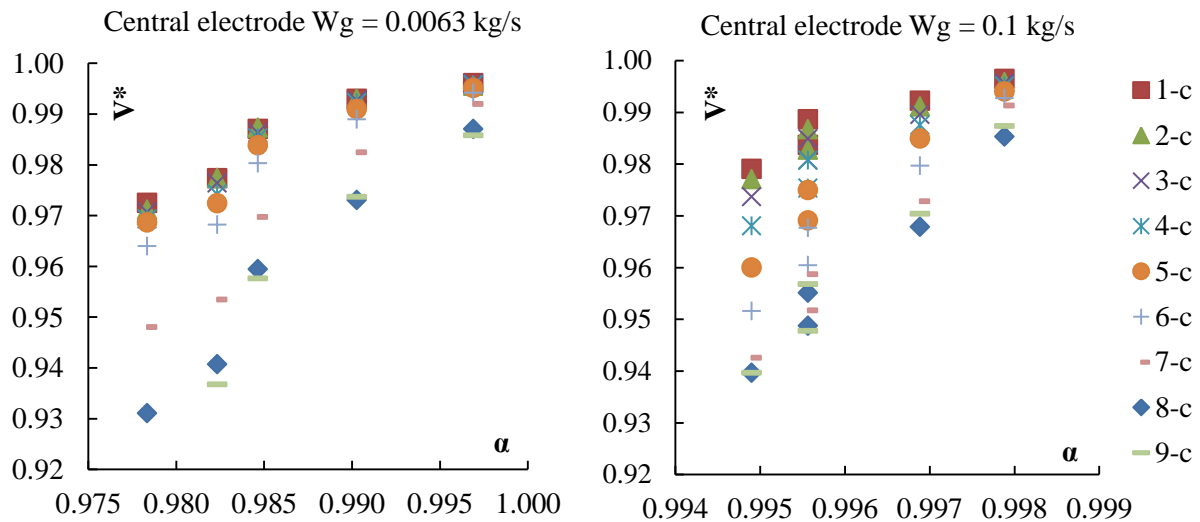

Figure 11. Dependency of the neighbouring electrodes on the void fraction (central electrode).

5. Conclusions

A preliminary methodology and the procedures to characterize a spool piece constituted by a Venturi flow meter and an Electrical Capacitance Probe for the experimental estimation of the flow rates of the phases in a horizontal two phase flow have been presented. The results obtained show the good capability of the spool piece to measure the necessary physical quantities suitable for the estimation of the flow rates. The Electrical Capacitance Probe is useful for the recognition of the flow pattern as it is very sensitive to the characteristic parameters of the two-phase flow. The information of the void fraction distribution along the cross section can be used to define the most appropriate experimental correlation between the pressure loss on the Venturi flow meter and the superficial velocities of the phases, so to decrease the error in the estimation of the flow rates.

The use of the VFM for the estimation of the two-phase flow rate is promising because both irreversible and total pressure drops are highly influenced by the behaviour of the phases. Nevertheless, the information provided by the instrument is not self-standing as the complete characterization of the flow also requires the understanding of the flow regime and of the void fraction, which are provided in this case by the ECP.

With the aim to consolidate the presented methodology and to broaden its applicability for different flow patterns, future work will be devoted to the implementation of deterministic and probabilistic approaches for the analysis of the signals of the SP for higher void fraction conditions and transition flow regimes.

Acknowledgements

The present research has been supported by ENEA and by the ministry of economic development.

List of symbols

$L [m]$	Length of VFM	$W [kg/s]$	Flow rate
$D [m]$	Test section diameter	θ	Angle between electrodes
$d [m]$	Throat diameter of VFM	Φ^2	Two phase multiplier
$V [Volt]$	Voltage	J	Superficial velocity
α	Void fraction	Subscripts	
$T [^{\circ}C]$	Temperature	tot	Total
χ	Lockhart-Martinelli parameter	L	Liquid
x	Flow quality	G	Gas
$\rho [kg/m^3]$	Density	i, j	Indexes

References

- [1] De Salve M, Monni G, and Panella B 2013 *ANS Trans.* **108** 1013-16
- [2] Monni G, De Salve M, Panella B and Randaccio C 2013 *Sci. Technol. Nucl. Install* **2013** 1-12
- [3] De Salve M, Monni G and Panella B 2011 *Proc. UIT 2011* 107-12
- [4] De Salve M, Monni G and Panella B 2012 *J. Phys.: Conf. Ser.* **395**
- [5] Monni G, De Salve M and Panella B 2014 *Prog. in Nuc. En.* **77** 167-75
- [6] Monni G, De Salve M and Panella B 2014 *Proc. HEFAT 2014*
- [7] Monni G, De Salve M and Panella B 2014 *Exp. Therm. Fluid Sci.* **5** 213-21
- [8] Martinelli R C and Nelson D B 1948 *Trans. ASME* **70** 695
- [9] Lockhart R W and Martinelli R C 1949 *Chem. Eng. Prog.* **45** 39
- [10] Dukler A E, Wicks M and Cleveland R G 1964 *AIChE J.* **10** 38-43 and 44-51
- [11] Baker C R 2000 *Flow Measurement Handbook* (Cambridge University Press)
- [12] Jitschin W 2004 *Vacuum* **76** 89-100
- [13] Fang L D, Zhang T and Jin N D 2007 *J. Petroleum Sc. Eng.* **57** 245-56
- [14] Huang Z, Wang B and Li H 2003 *IEEE Trans. Instr. and Meas.* **52** 7-12
- [15] Wu Y, Li H, Wang M and Williams R A 2005 *Canadian J. Chem. Eng.* **83** 37-41
- [16] Warsito W and Fan L S 2001 *Chem. Eng. Sc.* **56** 6455-62
- [17] De Salve M, Monni G and Panella B 2010 Report RdS/2010/67, ENEA