

Energy diaphragm walls for Turin metro

*Original*

Energy diaphragm walls for Turin metro / Cornelio, C., DI DONNA, A., Barla, M.. - CD-ROM. - (2016). (European Geothermal Congress 2016 Strasbourg, France 19-24 Sept 2016).

*Availability:*

This version is available at: 11583/2654411 since: 2016-10-27T11:21:58Z

*Publisher:*

EGEC - European Geothermal Energy Council

*Published*

DOI:

*Terms of use:*

This article is made available under terms and conditions as specified in the corresponding bibliographic description in the repository

*Publisher copyright*

(Article begins on next page)

## Energy diaphragm walls for Turin metro

Chiara Cornelio<sup>1</sup>, Alice Di Donna<sup>1</sup>, Marco Barla<sup>1</sup>

<sup>1</sup>Dipartimento di Ingegneria Strutturale, Edile e Geotecnica, Politecnico di Torino, Turin, Italy

email address of (main) author: alice.didonna@polito.it

**Keywords:** Energy walls, geothermal energy, FEM.

### ABSTRACT

The increasing need for renewable sources of energy for heating and cooling of buildings and infrastructures makes energy geostructures an innovative and interesting technology, which is rapidly spreading all around the world. This category includes all underground structures that are in contact and can exchange heat with the subsoil, being transformed into low enthalpy geothermal systems. The thermal activation of diaphragm walls, which are normally required in urban constructions such as underground car parks or cut and cover tunnels, is the focus of this paper. The results of Finite Element numerical analyses, performed to estimate the heat exchange achievable by the geothermal activation of section 1 of the Turin Metro Line 2 tunnel currently under design in Italy, are described.

### 1. INTRODUCTION

Low enthalpy geothermal systems have always been largely used for space heating. Such applications offer one of the best way for providing sustainable energy in urban environment where the ground immediately below a city can be used as heat source and/or energy storage reservoir. Shallow geostructures like foundations, diaphragm walls, tunnel lining and anchors, have recently been employed as heat exchangers (Laloui & Di Donna 2013). Their thermal activation is obtained by installing absorber pipes inside them, in which a heat carrier fluid circulates and transfers heat from the ground, for heating during winter, and to the ground, for cooling during summer.

A number of examples of foundation slabs, piles and diaphragm walls used for heating and cooling purposes of large buildings exist, particularly in Austria, Germany, the UK and Switzerland (Brandl 2006; Adam 2009; Bourne-Webb et al. 2009; Pahud 2013; Xia et al. 2012). The application of this technology to tunnels is more limited to a few case

studies, i.e. the Lainzer tunnel of the U2 extension of the Vienna metro (Markiewicz & Adam 2003), the Austrian H8-Tunnel Jenbach (Fronl et al. 2010), the Germans Katzenberg railway tunnel (Franzius & Pralle 2011) and the Stuttgart-Fasanenhof Tunnel (Sneider & Moormann 2010). Nevertheless, an increasing number of scientific studies about feasibility and efficiency of geothermal tunnel activation reveals the growing interest in these applications (Barla & Perino 2014; Barla et al. 2016; Di Donna & Barla, 2016; Franzius & Pralle 2011; Markiewicz & Adam 2009; Nicholson et al. 2013; Zhang et al. 2013).

The application of this technology to section 1 of the Line 2 of Metro Torino (Italy), currently under design, is here investigated. The objective is to quantify, by means of Finite Element Thermo-Hydro simulations, the heat that could be extracted from and injected into the ground by the geothermal activation of the diaphragm walls and base slab of the tunnels.

### 2. TURIN METRO LINE 2

Turin Metro Line 2 will represent a fundamental line for metropolitan transport, connecting the southwest area of the city to the northeast zone. The total length of the line will be about 14.5 km, crossing densely inhabited areas like Barriera di Milano, Aurora-Rossini, City Center, Crocetta, Santa Rita, Mirafiori Nord. The significant extension of the line suggested the division into four sections (Figure 1).

The first one will employ the ancient railway cut and cover tunnel between Corso Grosseto and Corso Novara, which is no more in use. The infrastructure requires a section able to hold a double runway and two emergency platforms along the two sides.

The retaining structure is composed by two lateral 80-cm-thick and 14-m-depth diaphragm walls, while the basement is made of an 80-cm-thick concrete slab. The slab is at 8 m from the top surface and it is 7 m large (Figure 2).

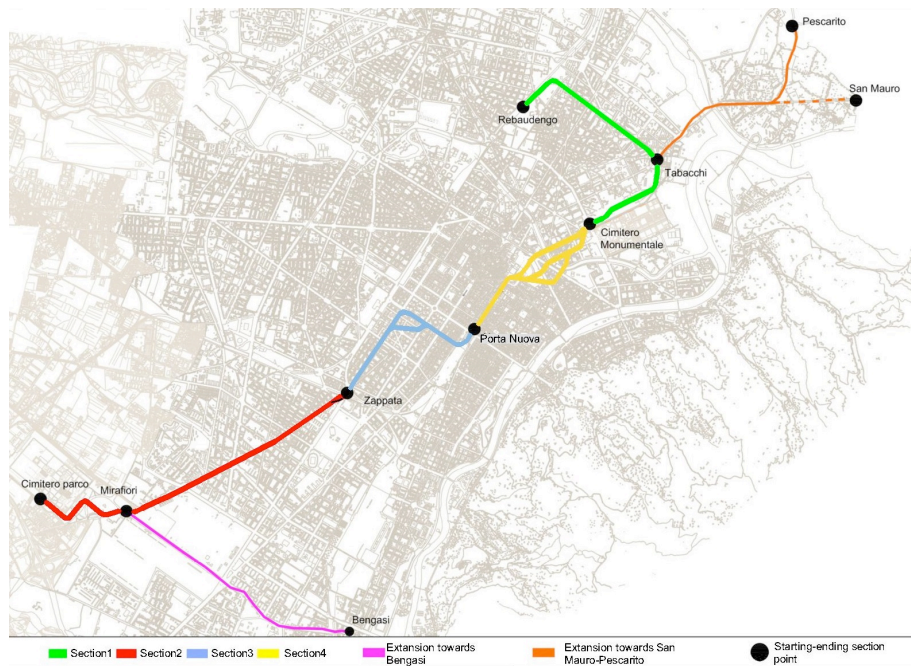

Figure 1: Layout of L2; section1 is shown in green.

The pipes of the geothermal circuit for the heat exchange are made of reticulated polyethylene (Pe-Xa) with an external diameter of 25 mm and thickness of 2.3 mm. They are located at 10 cm from the external boundary (towards the ground) of the diaphragm walls and slab, attached to the reinforcement cages. The pipes circuit installed in each diaphragm wall and slab are hydraulically connected in parallel to the adjacent one.

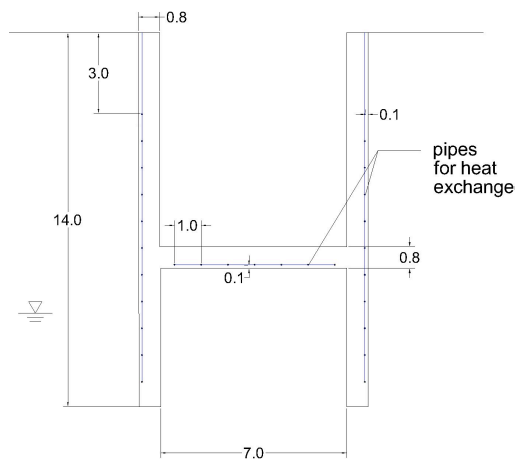

Figure 2: Diaphragm walls scheme.

### 2.1 Geological and geotechnical context

This study is supported by a wide knowledge and a large amount of data related to the Torino subsoil properties and conditions (Bottino & Civita 1986; Barla & Barla 2005, 2012; Barla & Vai 1999, Barla & Barla 2012). Turin metropolitan area is located at the western edge of the Po valley and has an overall surface of about 130 km<sup>2</sup>, 80% of which are a level area enclosed by rivers Stura di Lanzo, Po and

Sangone, while the remaining 20% are made up by hilly area connected to the low relief of Monferrato. The city area is situated on the end section of the great alluvium fan of the Dora Riparia river and appears to be almost flat with elevation ranging from 260-270 m a.s.l. to about 220 m a.s.l. The subsoil conditions in Turin are characterized by the presence of a sand and gravel deposit, ranging from medium to highly dense; below a depth of 8-10 m lenses of cemented soil are often present. An upper aquifer, with an average ground water flow of about 1.5 m/day is present in the city area. The aquifer is characterised by the hydraulic, hydro-dispersive and thermal parameters given in Table 1, known from in situ pumping tests and monitoring performed in an area of the city (Barla & Perino 2014).

Table 1: Hydraulic, hydro-dispersive and thermal parameters of the Turin subsoil.

Horizontal hydraulic conductivity	$k_x=k_z$ [m/s]	4.15E-03
Vertical hydraulic conductivity	$k_y$ [m/s]	2.08E-04
Volumetric capacity of the groundwater	$\rho_w c_w$ [MJ/m <sup>3</sup> /K]	4.2
Volumetric capacity of the solid	$\rho_s c_s$ [MJ/m <sup>3</sup> /K]	2
Thermal conductivity of the groundwater	$\lambda_w$ [W/m/K]	0.65
Thermal conductivity of the solid	$\lambda_s$ [W/m/K]	2.8
Anisotropy factor		1
Longitudinal thermo-dispersivity	$\alpha_L$ [m]	3.1
Transversal thermo-dispersivity	$\alpha_T$ [m]	0.3
Porosity of soil	$n$ [-]	0.25

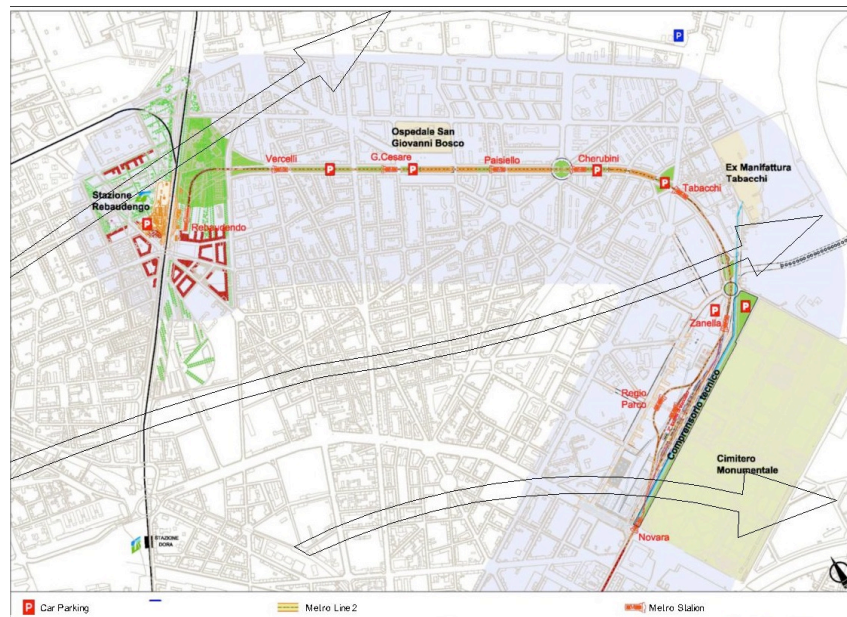

**Figure 3: Flow lines for section 1 of L2 based on Civita & Pizzo (2001).**

The groundwater level along the tunnel axis is known based on piezometric measurements, collected by the Agency for environmental protection ARPA Piemonte (Geologia e Dissesto - Banca Dati Geotecnica). In the zone of interest (Section 1 of L2), the groundwater table is about 11 m below the ground surface. Figure 3 shows the streamlines in the area as assessed by Civita & Pizzo (2001). In this area, the ground water flow can be simplistically considered almost perpendicular to the tunnel axis.

### 3. NUMERICAL MODELLING

With the purpose of quantifying the heat exchange and studying the influence of the geothermal activation of the tunnel on the environment, a thermo-hydraulic coupled analysis was performed with the FEM software FEFLOW®. The reader can refer to the

software manual (Diersch 2009) for the mathematical formulation.

A 3D model was constructed. Based on the assumption that the groundwater flow is perpendicular to the tunnel axis, the 3D model reproduces only the geometry of one single diaphragm wall panel and slab. Adjacent blocks should not influence the results from the thermal point of view.

The 3D FEM model built has a total volume of  $6876.64 \text{ m}^3$  and dimensions of  $70 \text{ m} \times 40 \text{ m} \times 2.5 \text{ m}$  with 414900 prismatic elements and 20 layers of 12.5 cm. The model was checked for mesh sensitivity. Figure 4 represents the front view of the mesh with the boundary conditions imposed in order to reproduce the Turin underground flow and external temperature and the detail of the schematic representation of the hydraulic circuit.

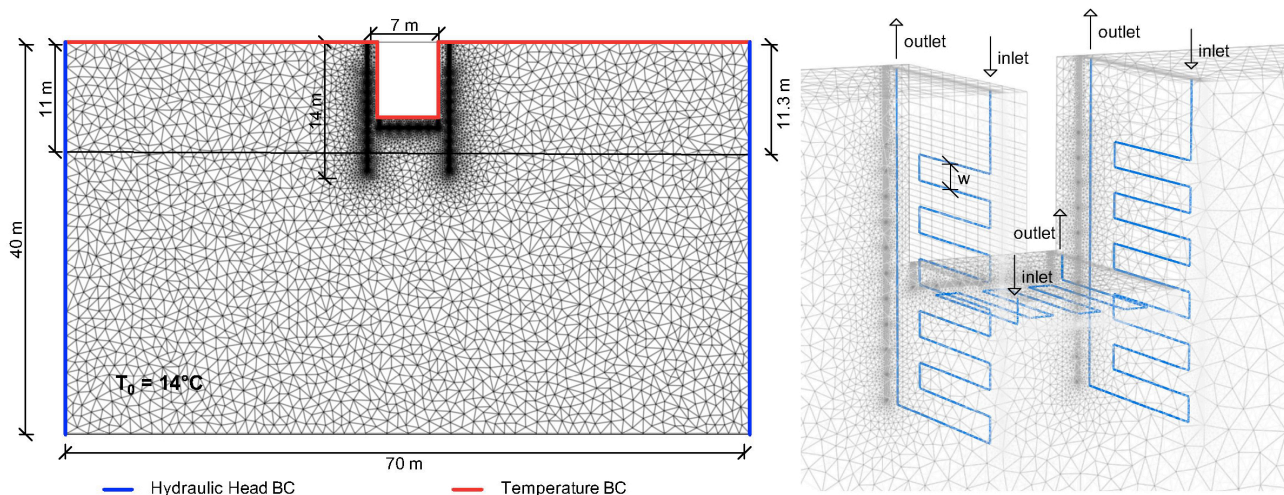
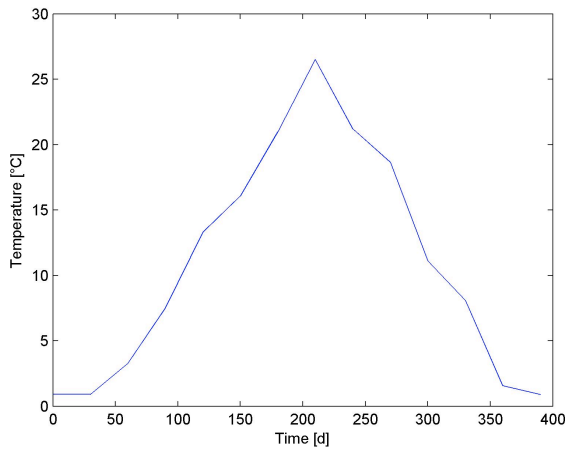

**Figure 4 Geometry and dimensions of the 3D model.**

As already mentioned, the groundwater flow is assumed perpendicular to tunnel axis and initialized imposing a hydraulic head gradient of 0.29 m between the left and right sides of the model, in order to have a groundwater flow velocity of 1.5 m/day. The heat-exchanger pipes are simulated using 1D discrete features; they are installed in both the diaphragm walls and the slab. Table 2 shows the characteristics of the pipes and the hydraulic parameters of the refrigerant fluid. The initial ground temperature is set to 14°C while the external air temperature variation is assumed as show in Figure 5, according to Torino climate monitoring data (Geologia e Dissesto - Banca Dati Geotecnica) and using a Dirichlet time series boundary condition.

**Table 2: Heat exchangers pipes characteristics.**

Outer diameters of pipes	D [mm]	25
Pipe thickness	s [mm]	2.3
Pipe distance	w [m]	1
Refrigerant volumetric heat capacity	$\rho_r c_r$ [MJ/m <sup>3</sup> /K]	4.13
Refrigerant thermal conductivity	$\lambda_r$ [W/m/K]	0.65



**Figure 5: External air temperature.**

According to the optimisation process presented by Barla et al. (2016), the activation of the geothermal system is simulated by imposing the inlet fluid velocity equal to 0.4 m/s and the inlet temperature varying as shown in Figure 6. The simulation reproduces one full year of activation. The heating season is assumed between October 15 and April 15 in accordance with the Regione Piemonte energy savings

regulations. The refrigerant fluid inlet temperature remains constant at 4°C during the three winter months and at 26.5°C during the three summer months.

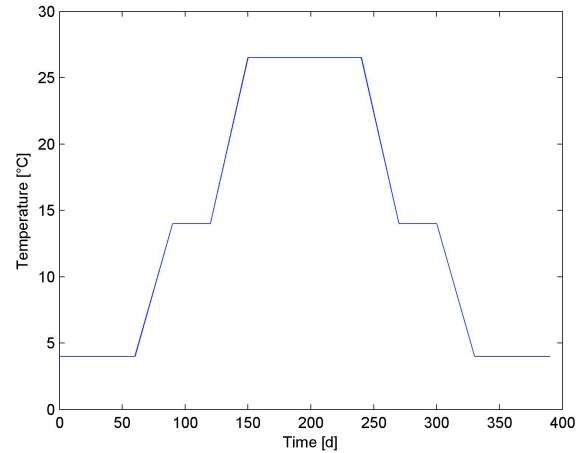

**Figure 6: Inlet temperature.**

#### 4. RESULTS

The computed temperature of the refrigerant fluid during the year is shown in Figure 7, compared to the input temperature.

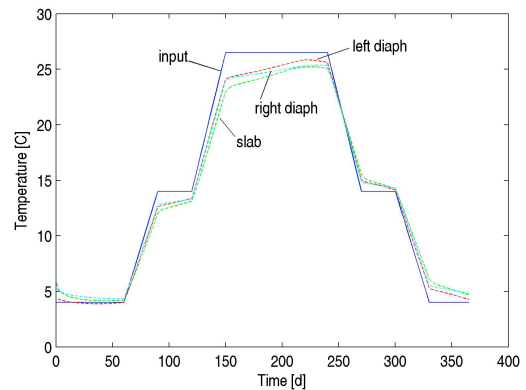
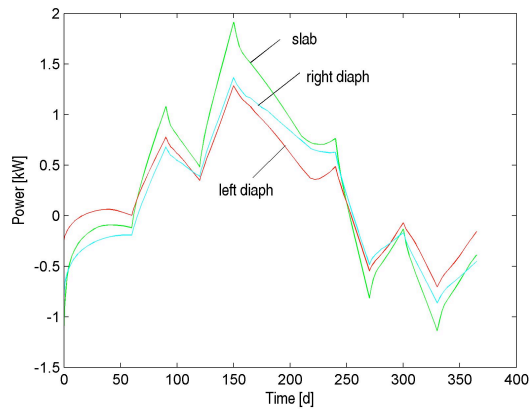

**Figure 7: Input and output temperature of the refrigerant fluid.**

The exchanged heat power  $Q$ , measured in Watt, extracted from the ground during winter and injected into the ground during summer, can be computed as:

$$Q = m c_w |T_{wo} - T_{wi}| \quad [1]$$

where  $m$  is the mass flow rate [kg/s],  $T_{wi}$  is the inlet temperature and  $T_{wo}$  is the outlet temperature. The result in terms of exchanged heat [kW] is shown in Figure 8.



**Figure 8: Heat exchanged during a year.**

Because of a higher difference between input and output temperature, in summer the efficiency is better than in winter. Tables 3 and 4 show the exchanged power in W per  $m^2$  of diaphragm wall and slab surface, computed from the average difference in temperature from day 180 to day 213 for cooling (summer period) and from day 330 to day 365 for heating (winter period).

**Table 3: Exchanged heat - Cooling mode.**

	$\Delta T$ [°C]	Q [kW]	Q [W/m <sup>2</sup> ]
Left diaphragm	1.171	0.641	18.31
Right diaphragm	1.565	0.857	24.47
Slab	1.812	0.992	56.67
Total		2.489	28.45

**Table 4: Exchanged heat - Heating mode.**

	$\Delta T$ [°C]	Q [kW]	Q [W/m <sup>2</sup> ]
Left diaphragm	0.782	0.405	11.57
Right diaphragm	1.167	0.620	17.70
Slab	1.299	0.675	38.58
Total		1.700	19.43

In both cooling and heating modes, the slab has a better efficiency than diaphragm walls. Indeed, it contributes to more than 50% of the total exchanged heat power, probably due to the fact that the average ground temperature below the slab is less influenced by external air temperature variations than that of the ground close to the diaphragm walls. Moreover, the slab is entirely under the ground water level, which is

a favourable condition for the heat exchange as thermal conductivity improves and the contribution of convection is relevant. Conversely, most of the walls surface is above the ground water level.

According to the European study EPISCOPE and its Italian case study TABULA (Corrado et al. 2012), the annual energy demand for heating and domestic hot water for a new building, can be estimated as  $Q_{\text{need}} = 102 \text{ KWh/m}^2$ . Therefore, for instance, a reference residential building with 36 apartments requires a total power of 293.6 MWh.

A low-enthalpy system is always combined with heat pumps, whose COP value should be greater or equal than 4 for economical reasons (Brandl 2006). With a heat pump with COP of 4 and 1800 hours of activation, it follows that the needed length of thermo active tunnel is 189 m. Since the extension of the Metro Line 2 with perpendicular groundwater flux is 1860 m, its geothermal activation should be able to cover the energy demand of 9 reference residential buildings. Figure 9 shows the planned residential estates in the area, so called Variante 200, close to the L2 metro line. The 9 buildings that could be heated and cooled thanks to the energy tunnel are highlighted in red.

## 5. CONCLUSION

This paper discussed the benefit opportunity of thermal activation of the tunnels of Turin Metro Line 2. The cut and cover tunnels are composed by two diaphragm walls and a slab, all equipped with pipes in which a refrigerant fluid can flow with a given velocity. Using a 3D FEM model, the heat exchange between the ground and the structure was simulated. It appears that the exchanged heat will be able to satisfy the energy demand of 9 new standard residential buildings in the north-east area of the city, where the groundwater flow is perpendicular to the axis of the tunnel.

In-situ tests are necessary in order to improve the knowledge on thermo-hydraulic parameters of the ground and have a better prediction of energy efficiency. In addition, evaluation of technical and economical feasibility is recommended. However, despite the preliminary status of the results, one can conclude that this application is promising and should be further investigated.

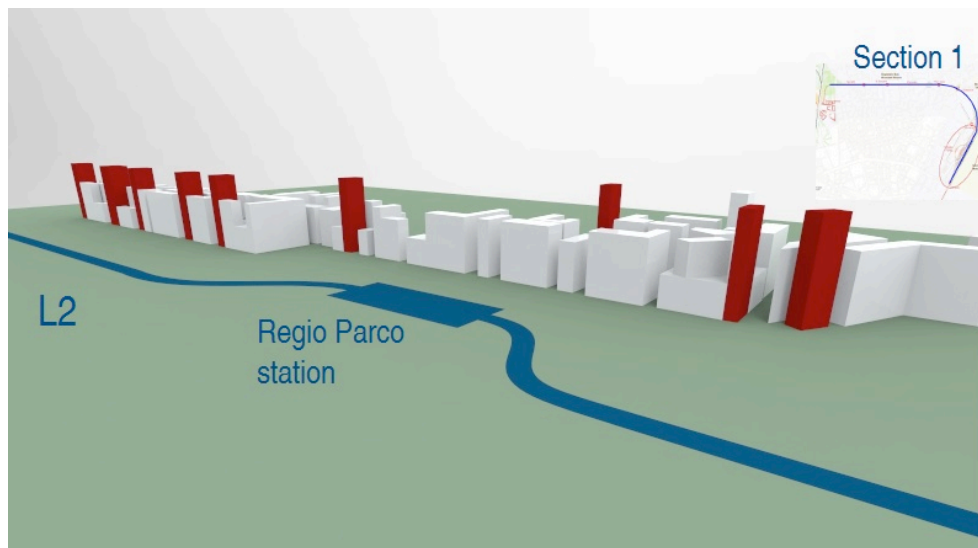

**Figure 9: New buildings planned close to Section 1 of Turin Metro Line 2 (blue line); in red those to be heated by the energy tunnel.**

## REFERENCES

- Adam, D.: Tunnels and foundations as energy sources-practical applications in Austria. *5th International Symposium on Deep Foundations on Bored and Auger Piles*, 2009, 337-342.
- Barla, G., and Vai, L.: Indagini geotecniche per la caratterizzazione del sottosuolo di Torino lungo il tracciato del passante ferroviario. *XX Convegno Nazionale di Geotecnica*, Parma, Italy, (1999).
- Barla, M. and Barla, G.: Assessing design parameters for tunnelling in a cemented granular soil by continuum and discontinuum modelling. *Proc. 11th Iacmag Conference*, Torino, Italy, (2005), Vol. 4, 475-484.
- Barla, M. and Barla, G.: Torin subsoil characterisation by combining site investigations and numerical modelling, *Geomechanik und Tunnelbau 5*, (2012), 214-231.
- Barla, M. and Perino, A.: Geothermal heat from the Turin metro south extension tunnels, *Proceedings of the World Tunnel Congress 2014 – Tunnels for a better Life*. Foz do Iguaçu, Brazil. (2014).
- Barla, M., Di Donna, A. and Perino, A.: Application of energy tunnels to an urban environment. *Geothermics 61*, (2016), 104-113.
- Bourne-Webb, P., Amatya, B., Soga, K., Amis, T., Davidson, C. and Payne, P. Energy pile test at Lambeth College, London: geotechnical and thermodynamic aspects of pile response to heat cycles. *Géotechnique 59 (3)*, (2009), 237-248.
- Brandl, H.: Energy foundations and other thermo-active ground structures. *Geotechnique 56 (2)*, (2006), 81-122.
- Civita, M. and Pizzo, S.: L'evoluzione spaziotemporale del livello piezometrico dell'acquifero libero nel sottosuolo di Torino. *Ambiente e sviluppo sostenibile*, (2001).
- Corrado, V., Ballarini, I. and Corgnati, S.: *National scientific report on the TABULA activities in Italy*, Torino, Italy, (2012).
- Di Donna, A. and Barla, M.: Energy walls for an underground car par. *25th European Young Geotechnical Engineers Conference, 21st-24th June 2016*, Sibiu, Romania, (2016).
- Diersch, H.: DHI Wasy Software - Feflow 6.1 - Finite Element Subsurface Flow & Transport Simulation System: Reference Manual, (2009).
- Franzius, J. N. and Pralle, N.: Turning segmental tunnels into sources of renewable energy. *Proceedings of ICE - Civil engineering 164*, (2011), 35-40.
- Frodl, S., Franzius, N. J., and Bartl, T.: Design and construction of the tunnel geothermal system in Jenbach. *Geomechanics and Tunneling 3, No. 5*, (2010), 658-668.
- Laloui, L. and Di Donna, A.: *Energy geostructures: innovation in underground engineering*. ISTE Ltd and John Wiley & Sons Inc, (2013).
- Markiewicz, R. and Adam, D.: Energy from earth-coupled structures, foundations, tunnels and sewers. *Géotechnique 59*, (2009), 229-236.
- Markiewicz, R. and Adam, D.: Utilisation of Geothermal Energy using Earthcoupled Structure

- Theoretical and Experimental Investigations, Case Histories. *Geotechnical Problems With Man-Made And Man Influenced Grounds. XIII European Conference on Soil Mechanics and Geotechnical Engineering., Volume 2*, Prague, (2003).

Nicholson, D. P., Chen, Q., Pillai, A. & Chendorain, M. Developments in thermal piles and thermal tunnel lining for city scale GSHP system. *Thirty-Eighth Workshop on Geothermal Reservoir Engineering*. Stanford University, CA, USA.

Pahud, D.: A case study: the dock Midfield of zurich Airport, in: *Energy Geotechniques: Innovation in Underground Engineering*, Laloui, L., and Di Donna, A., 281-295, *ISTE Ltd. and John Wiley & Sons Inc.*, (2013).

Xia, C., Sun, M., Zhanga, G., Xiaoa, S. and Zoua, Y.: Experimental study on geothermal heat exchangers buried in diaphragm walls. *Energy and Buildings* 52, (2012), 50-55.

Zhang, G., Xia, C., Sun, M., Zou, Y. and Xiao, S.: A new model and analytical solution for heat conduction of tunnel lining ground heat exchangers, *Cold Regions Science and Technology* 88, (2013), 59-66.