

Using Discrete Event Simulation Models to Evaluate Resilience of an Emergency Department

Original

Using Discrete Event Simulation Models to Evaluate Resilience of an Emergency Department / Cimellaro, GIAN PAOLO; Malavisi, Marzia; Mahin, Stephen. - In: JOURNAL OF EARTHQUAKE ENGINEERING. - ISSN 1363-2469. - ELETTRONICO. - (2016), pp. 1-24. [10.1080/13632469.2016.1172373]

Availability:

This version is available at: 11583/2652923 since: 2019-08-02T17:53:53Z

Publisher:

Taylor and Francis Ltd.

Published

DOI:10.1080/13632469.2016.1172373

Terms of use:

This article is made available under terms and conditions as specified in the corresponding bibliographic description in the repository

Publisher copyright

(Article begins on next page)

USING DISCRETE EVENT SIMULATION MODELS TO EVALUATE RESILIENCE OF AN EMERGENCY DEPARTMENT

G.P. Cimellaro¹, M. Malavisi², S. Mahin³

ABSTRACT

Hospitals are critical infrastructures which are vulnerable to natural disasters, such as earthquakes, man-made disasters and mass casualties events. During the emergency, the hospital might also incur in structural and non-structural damage, have limited communication and resources, so they might not be able to treat the large number of incoming patients. For this reason, the majority of medium and large size hospitals have an emergency plan that expands their services quickly beyond normal operating conditions to meet an increased demand for medical care, but it is impossible for them to test it before an emergency occurs. The objective of this paper is to develop a simplified model that could describe the ability of the Hospital Emergency Department to provide service to all patients after a natural disaster or any other emergency. The waiting time is the main response parameter used to measure hospital resilience to disasters. The analytical model has been built using the following steps. First, a discrete event simulation model of the Emergency Department in a hospital located in Italy is developed taking into account the hospital resources, the emergency rooms, the circulation patterns and the patient codes. The results of the Monte Carlo simulations show that the waiting time for yellow codes, when the emergency plan is applied, are reduced by 96%, while for green codes by 75%. Then, using the results obtained from the simulations, a general metamodel has been developed, which provides the waiting times of patients as function of the seismic input and the number of the available emergency rooms. The proposed metamodel is general and it can be applied to any type of hospital.

Keywords: *Resilience, health care, infrastructure, Emergency Department, metamodel, emergency, hospital, performance.*

1 INTRODUCTION

The capacity of a geographical area to react and resist to an emergency, regardless the spatial scale of the area interested is strictly related to the proper functioning of its own infrastructure systems. This reliance becomes painfully evident when critical infrastructure systems fail during a disaster, becoming one of the most important causes of economic and human losses.

Hospitals have been recognized as part of the critical infrastructure system, because they must continue to function when an emergency occurs and must supply essential health services to the community during the disaster. Within a short period, hospitals have to provide care to a large

¹ Visiting Professor, Department of Civil and Environmental Engineering, University of California Berkeley, Davis Hall, Berkeley, CA 94720-1710, USA (gianpaolo.cimellaro@polito.it)

² Graduate Research Assistant, Department of Structural, Geotechnical and Building Engineering (DISEG), Politecnico di Torino, 10129 Turin, Italy

³ Director, Pacific Earthquake Engineering Research Center, Byron and Elvira Nishkian Professor of Structural Engineering, 777 Davis Hall, University of California, Berkeley, CA USA 94720-1710

number of injuries whose lives are at risk and they must have the ability to expand their services quickly beyond normal operating conditions to meet an increased demand for medical care. Furthermore, assuming they can be damaged due to the extreme event, they still need to be safe, accessible and functioning at maximum capacity in order to provide critical services. A safe hospital means that it must be organized with contingency plans in place and the health personnel should be trained to keep the network operational.

An effective way to measure and analyze how hospitals can react to disasters is through the *resilience analysis* [Cimellaro et al., 2010]. Resilience of healthcare facilities can be defined as a hospital's ability to withstand the event, absorb the shock of disasters while maintaining and surging their medical capacity in order to recover quickly to its original state or adapt to a new one.

Between all the hospital Departments, the Emergency Department (ED) is the key unit in the hospital during a disaster. In fact, the ED plays a pivotal role in the delivery of acute ambulatory and inpatient care, providing immediate assistance request during 24 hours period [Morganti et al., 2013].

Different parameters can be used to evaluate the performances of the ED and, among these indicators, the most representative one is the *waiting time*. Patient waiting time plays an increasingly important role to measure hospitals' ability to provide emergency care to all the injured in an extreme situation [Cimellaro et al., 2011]. The time patients wait to receive assistance is considered a visible and significant indicator of ED resilience. In fact, the overcrowding in the ED is an undesirable event which leads to care delays and risk of lives. Hospitals' performance during the emergency can be improved by adopting operations-management techniques and related strategies to enhance efficiency, taking into account not only the internal organization of the hospital, but rather the interaction and coordination with other healthcare facilities.

In this research, a simplified model has been developed in order to describe the performance of an ED during an emergency.

The entire process during which patients enter the ED, interact with medical staff, receive all the treatments they need and finally are dismissed has been analyzed, to measure the patients *waiting time*, which has been chosen as hospital performance measure to determine its resilience.

First, a discrete event simulation model has been developed for the hospital's ED considering different scenarios. Then, from the numerical output of the DES model, a *metamodel* has been created. The metamodel, also called *surrogate model*, is the “model of a model”. In other words is the simplified model of a more complex one and it is usually represented as an analytical equation or an algorithm. The proposed metamodel is able to model the performance of the any ED during an emergency, using as input, the intensity of the seismic input and the number of available emergency rooms.

2 LITERATURE REVIEW

The majority of the studies which focus on evaluating the service quality and efficiency of the healthcare facilities are based on the *patients' waiting time*, which is the time the patient is waiting before receiving assistance by a doctor [Dansky and Miles, 1997]. Many studies have been developed over the years to analyze how decrease the patient waiting times. One of the earliest studies has been conducted by Fetter and Thompson (1965), which analyzed the doctors utilization rates with respect to patient waiting time using different input variables (e.g. patient load, patient early or late arrival patterns, walk-in rates, physician service etc.). Later, in the nineties, Kirtland et al. (1995) developed some of the first studies in the optimization of human resources analyzing how to improve patient flow in an ED. They have identified three alternatives that can save on average thirty eight minutes of waiting time per patient. Later, Martin et al. (2003) have analyzed the parameters and the strategies which can be used to decrease the patient waiting time and therefore improving the hospital performance.

Takakuwa et al. (2004) have proposed a procedure for planning emergency room operations that minimize patient waiting times. They found that patient waiting time is substantially reduced by adding a more appropriate number of doctors and medical equipment. A similar study to assess the effect of some possible changes in the ED processes is also presented by Mahapatra et al. (2003) which showed that the addition of a care unit improved the average waiting times by at least 10%. Later, Lau (2008) have studied new patients scheduling rules for three Orthopedic Clinics across Ontario to find solutions to long patient waiting times by proposing a new scheduling algorithm. Santibáñez et al. (2009) provided a framework on how to reduce the waiting time and improve the resource allocation using a computer simulation model of the Ambulatory Care Unit (ACU). Later, Yerravelli (2010) have studied the patients' waiting times at KCH Emergency Department. The objective of the research is to evaluate the hospital performance as well as identify the opportunity by reducing waiting times using the KCH ED model. Furthermore, resources utilization is taken into account to determine the required staffing levels and minimize the operating costs. Duda (2011) examined whether hospital strategies were aligned with its processes. In particular, he analyzed the patients' flow, the time spent in the hospital between the arrival and service characteristics. His goal is identifying which processes need to be changed and which alternatives have to be taken into account to increase the effectiveness of the patient flow processes and to reduce the waiting time. More recently, Hu (2013) studied an optimal human resource allocation in order to reduce the patient waiting time using Discrete Event Simulation models (DES) on an existing Clinic. DES models are widely used to simulate hospitals, because healthcare facilities are complex systems with multiple interactions between patients, doctors, nurses, technicians, different departments and circulation patterns. The interaction between all these components is described realistically by DES models. Many studies have been performed over the years and nowadays are possible to find several references related to this field [Günel and Pidd, 2010]. DES models are also used as a communication tool between the hospital administration and the model developers helping the administrators understanding the performance of the different healthcare processes [Curran et

al., 2005; Morales, 2011]. Moreover, DES model allows investigating and planning the use of the hospital resources [Šteins, 2010].

Other examples of ED which has been modeled using DES models are available in literature.

For example, Samaha et al. (2003) **Error! Reference source not found.** has developed a DES model of the ED and tested different scenarios by concluding that the waiting time is *process related* and not *resource related*, so according to the authors the *triage* with “fast track “area can reduce the patient waiting time.

Later, Komashie and Mousavi (2005) has conducted sensitivity analysis by varying the number of *beds, doctors, nurses* in the simulation model to reduce the waiting time.

Davies (2007) developed a new approach called “See” and “Treat “method, where the triage process is eliminated and the patients are directed by a qualified receptionist to the doctor or to a emergency nurse practitioner (ENP) based on the patient condition. This approach is supposed to eliminate the patient waiting time by simplifying the service.

Medeiros et al. (2008) has developed a DES model for the ED by implementing a new approach known as PDQ (Provider-Directed-Queuing) which can reduce non-critical patients waiting time and increase the room availability for the critical patients. Recently, DES models have been used also by Morgareidge et al. (2014) to optimize the design of the ED space and the care process for a specific case study.

In this paper, the ED of a hospital has been modeled using a DES model. Different scenarios have been considered assuming different patient arrival rates for different seismic intensities and different levels of functionality generated by incurring structural damage. Then, a simplified analytical model has been proposed to evaluate the patients waiting time without the need to run complex discrete event simulation models.

In 2011, Cimellaro et al. have also developed a metamodel to study the performance of an ED following an earthquake. However, with respect to their model which is related to hospitals located in California, the proposed one is able to distinguish between different codes (red, yellow, green

etc.), including also the intensity of the seismic input and reducing the number of parameters from three to two. These improvements of the model have been possible due to the large availability of patient's data provided by a hospital located in downtown in Turin which has been used as case study in this example and which allowed a refined calibration of the model.

3 METHODOLOGY

In this paragraph is described the methodology used in the paper to develop the metamodel of an ED, using the step-by-step procedure below:

1. Creation of a *discrete event simulation model* for the ED with and without emergency plan, using as input data the estimated patient arrival rate in normal as well as in emergency operating conditions;
2. Development of a *metamodel* to evaluate the hospital waiting time using a reduced number of input parameters: the magnitude of the seismic input and the number of non functional emergency rooms;
3. Development of a *general metamodel* that can be applied to any hospital;

In the next paragraphs are described in detail the different steps of the procedure.

4 DISCRETE EVENT SIMULATION MODEL FOR THE ED

Simulation modeling is the process of creating a discretization of an existing *physical system* to predict its performance in the real world. The steps to develop the model are described in the following paragraphs.

4.1 Description of the case study

The hospital considered for the analysis is the Umberto I Mauriziano Hospital located in Turin, Italy (Figure 1). The hospital is placed in the southeast part of the city, approximately 3 km far from the center. It was built in 1881, but it was bombed quite a few times during World War II, so several units are now rebuilt or extended. Currently it includes 17 units, which correspond to different departments, and it covers an overall surface of 52827 m². While developing the simulation model, only the Emergency Department, which is located in the building 17, has been considered (Figure 2).



Figure 1. Umberto I Mauriziano hospital, Turin

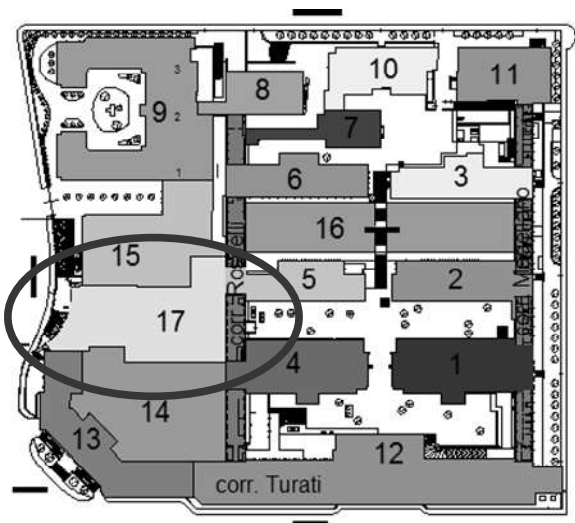

Figure 2. Hospital's units – Emergency Department building

The ED consists of an entrance area in which "triage" is carried out, and four macro areas corresponding to the 4 different color codes, that represent the severity of injury. In particular, these four color codes are *red*, *yellow*, *green* and *white*. *Red codes* (emergency) identify patients with compromised vital functions, already altered or unstable whose lives are at risk. *Yellow codes* (urgency) are patients who are not in immediate danger of life but present a partial impairment of vital functions. *Green codes* (minor urgency) have a no critical situation, so their lives are not at risk and their injuries do not affect vital functions. *White codes* (no urgency) include all patients

who have neither serious nor urgent injuries and who do not really need to be in the ED, so their treatment can be provided by a general doctor.

The ED is normally divided in four main areas but, when the Emergency Plan is applied, the number of areas is reduced to three (Figure 3), because in emergency conditions the white codes are sent to another facility outside the ED. In emergency condition, red codes area is located immediately in front of the ambulance entrance and contains two rooms in which patients receive the first treatments. Parallel to this area, there is the yellow codes' area composed of three emergency rooms, while green codes' area is situated perpendicular to yellow and red codes' areas and includes two emergency rooms. Each area is provided with waiting rooms in which patients can wait before being treated. Moreover, inside the ED there are recovery rooms in which patients can stay before being discharged or recovered in another part of the hospital.

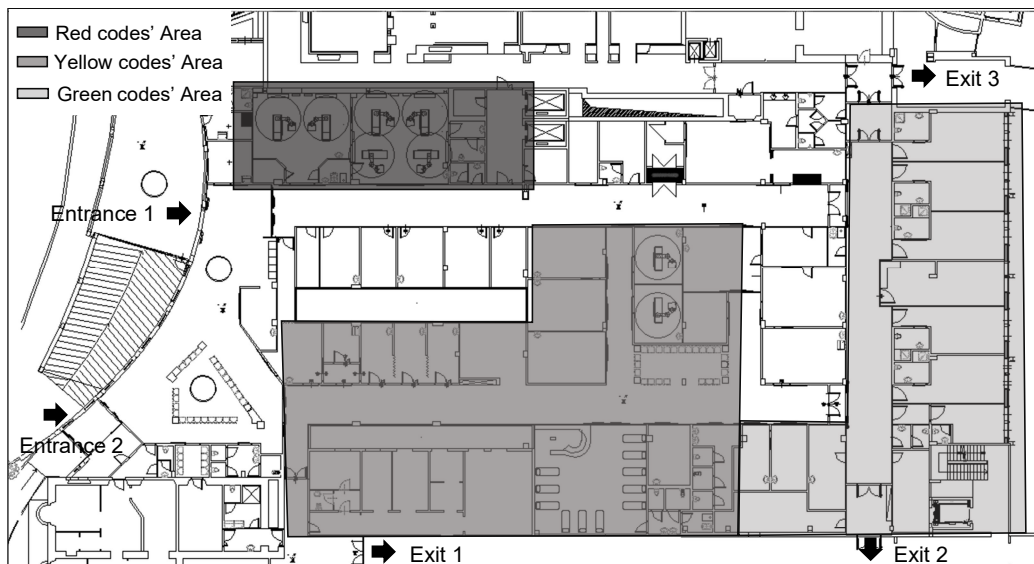

Figure 3. Emergency Department color-codes areas

4.2 Description of the model and assumptions

In this research, the ED (Figure 4) has been simulated using a discrete event simulation (DES) model built in ProModel® 7.00 [Promodel, 2014] (downloaded on February 15, 2014). ProModel is a discrete-event simulation software that is used to plan, design and improve complex systems such as tactical and operational systems. Discrete Event Simulation (DES) model has been selected to study the hospital, because ED is a complex and dynamic system in which the variables state change continuously over time. In addition, DES models allow users to test different asset allocations which are characterized by complex relationships between system processes.

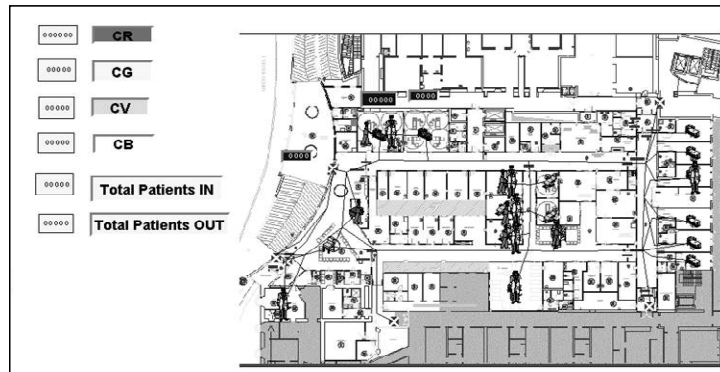

Figure 4. DES model of the Mauriziano ED

In detail, in the model, it is assumed that the hospital structural and non-structural elements remained undamaged after the earthquake. Four codes have been considered to divide the patients arriving in the ED: red, yellow, green and white. Actually, the Emergency Plan of the hospital considers also blue and black codes that represent respectively “*compromised vital functions*” and “*death*”. While developing the model, these two additional codes have not been considered, because they have no influence on patients’ waiting times. It is also assumed, that once the code is assigned according to the triage, the patients cannot change their status while their staying in the ED. All the assumptions in the model have been approved by the Emergency Department Staff and the Emergency Plan Director of the Hospital. The analyzed ED consists of emergency rooms (ER)

which are different for each color code area, two waiting rooms (WR), a triage room (Triage), an examination area, a critical area, one shock room (SR) and one intensive reanimation room (IR), several observation rooms (OR) and some separate stations (Figure 5).

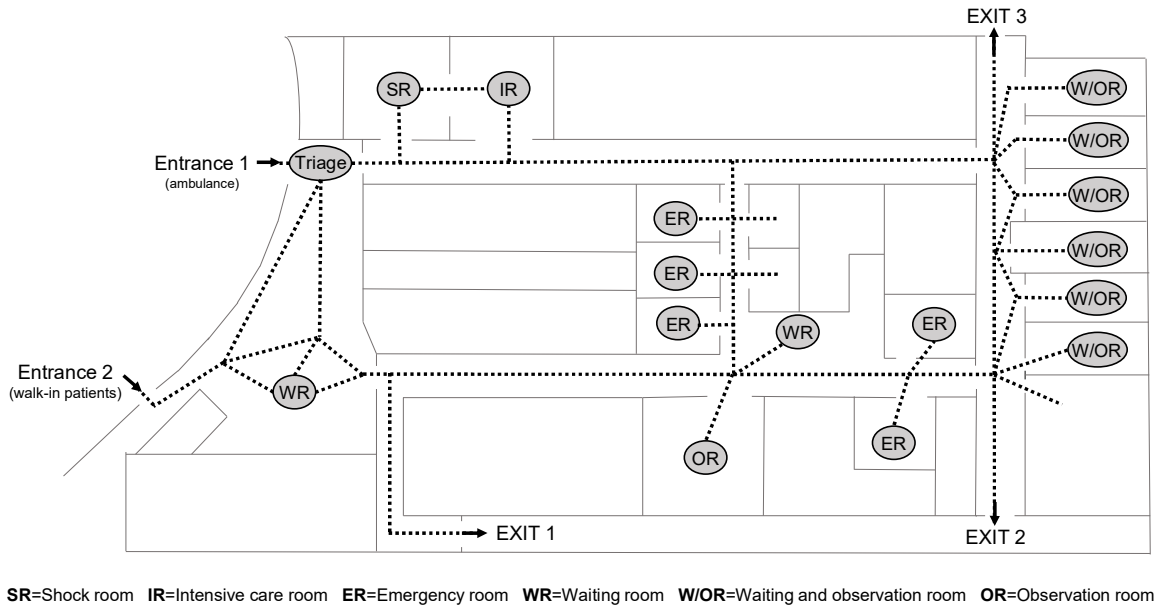

Figure 5. Patient path in the Emergency Department

There are two entrances to the ED; one is for ambulance only, while the second is for patients and visitors. The first one is located in the northwest part of the ED, near the red code area, while the second one is in the southwest side. Therefore, the patients that arrive by ambulance or car (e.g. red codes) enter through the north entrance, which is closest to the shock and intensive care rooms. On the other hand, all other *walk-in patients* use the south entrance that is nearest to the yellow and green codes areas. There are three exits from the ED, which are used according to the patient destination (healthcare facilities, hospital wards, dismissed). They are situated in the south, northeast and southeast sides of the ED. Each place is called “*location*” according to Promodel terminology and have a given assigned capacity. Some locations, such as the entrances, the exits, and the waiting rooms, have an infinite capacity while others, like the emergency rooms, the shock

room, the intensive care room, have a defined number of patients who can be treated at the same time.

Inside the locations, the “*entities*” carried out their duties. In this model, the *entities* are the patients visiting the ED that are categorized according to the severity of their injury. In particular, they have been divided into four categories corresponding to the four color codes: red, yellow, green and white codes. An entry, a path and a travel speed has been assigned to each patient type. For example, yellow, green and white codes travel at the speed of 50 mpm, while red codes travel at the speed of 60 mpm.

Patients, nurses and doctors follow a predefined “*network path*” (Figure 5) composed of nodes and edges (dotted lines) which can be unidirectional or bidirectional. Not all the paths are accessible to all the entities. For example, the passage from the red to the yellow area is available only for the medical staff. Furthermore, if multiple path options are available at a single node, then the shortest distance path is selected.

The “*resources*” correspond to the medical doctors, nurses, health care operators, etc. They are divided into two categories: those that provide service from a fixed station and those that travel through the ED. Each resource has its own schedule which is summarized in Table 1, according to the color code.

Table 1. Resources definition

Color codes area	Work schedule	Resources
Red area	hours 8/20	2 doctors, 4 nurses
	hours 20/8	2 doctors, 3 nurses
Yellow area	hours 8/20	5 doctors, 3 nurses

	hours 8/20	5 doctors, 3 nurses
Green area	hours 8/20	3 doctors, 5 nurses
	hours 8/20	2 doctors, 3 nurses

The “*processes*” are all the actions that the entities carry out within the ED, such as the patient’s movements from one location to another, but also how much time they spend in each location and how and for how long they use a particular resource.

Below is given a description of all the actions which has been modeled according to the color codes.

Red Codes. Red codes generally arrive by ambulance at entrance 1. As soon as they arrive, due to the severity of their condition, they are sent directly to the shock room and the intensive care room in the red zone where critical patients are treated immediately.

After receiving the first treatment in these two rooms, some patients are displaced in the yellow area in the ED, others are transferred to the hospital ward and the remaining part leaves the hospital (they could move to another healthcare facility or dismissed).

Yellow Codes. Yellow code patients generally can arrive from both Entrance 1 and 2. After the triage, they remain in the waiting room reserved for the yellow codes until one of the emergency rooms is available. While waiting, some of them are kept in the observation room where they receive the first aids. After being assisted in the emergency rooms, some patients leave the hospital while others are sent to the examination room. Once the check is done, the patients are sent back to the emergency rooms or to the green codes area. From the emergency rooms, a part of them leaves the ED (toward the hospital wards or others healthcare facilities) while the remaining patients are sent back to the examination room until their condition is identified and they can leave the ED.

Green Codes. In general, the green codes go in from the entrance 2. After the triage, they are sent to the observation rooms in the green area. Over there, any available nurses treat the green codes with

less injury, so they can leave the ED earlier. The others wait for an available emergency room. After receiving treatment, they leave the hospital or move to an examination room and then they go to the hospital wards or they are dismissed.

White codes. White codes also go in from the entrance 2. After the triage, if the emergency plan is active, the white codes leave the ED, because they have minor injuries.

All the *processes* and *patient paths* that take place in the ED during an emergency have been identified through interviews with the staff and the personnel of the ED. The results of these interviews are shown in the flow map (Figure 6), which has been approved by the hospital's personnel. It is important to mention that the input data for the emergency plan have been determined from public interviews with hospital's medical staff, since the current emergency plan has never been applied in the hospital so far.

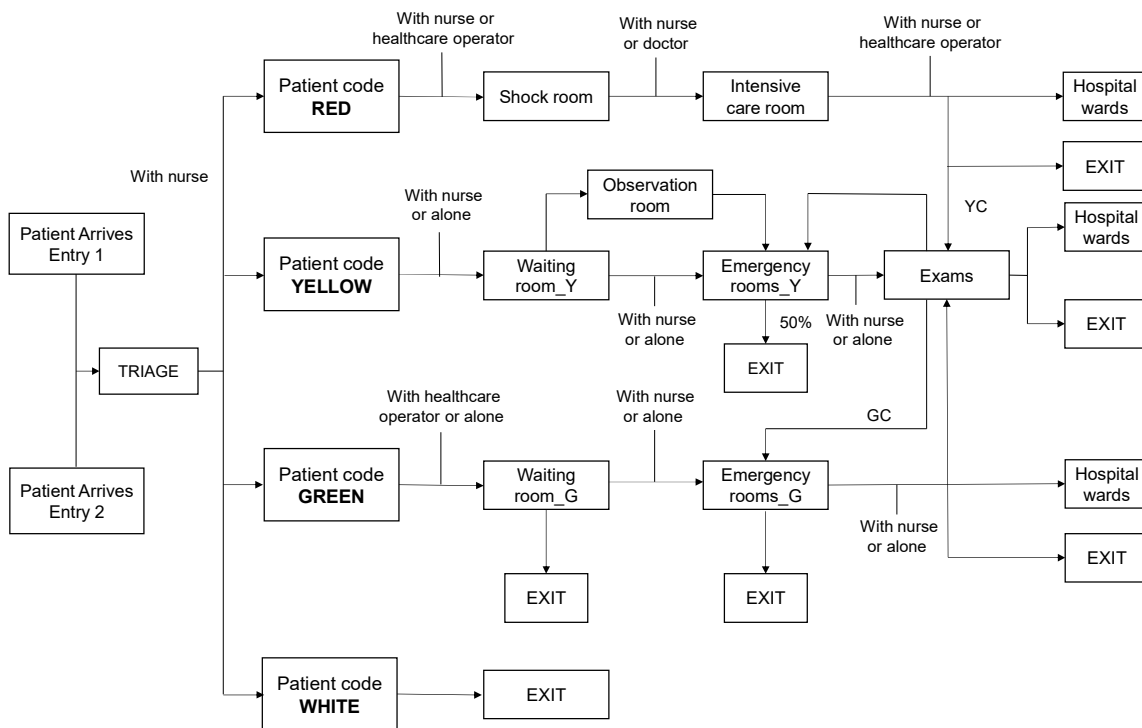

Figure 6. Process map for the Emergency Department

4.3 Calibration of the model in normal and emergency operating condition

The *patients' arrival rates* in normal operating conditions have been calculated using the hospital's register statistics. However, other information has been also extracted by the hospital's register statistics such as the patient's inflow, the check-in and checkout time, the time spent in each room as well as patients' movements from one location to another. Moreover, the patient arrivals in the ED vary from hour to hour and, in order to determine the patient arrival distributions, an arrival cycle has been defined using the data provided by the hospital database that have been used to calibrate the model. The distribution is shown in Figure 7.

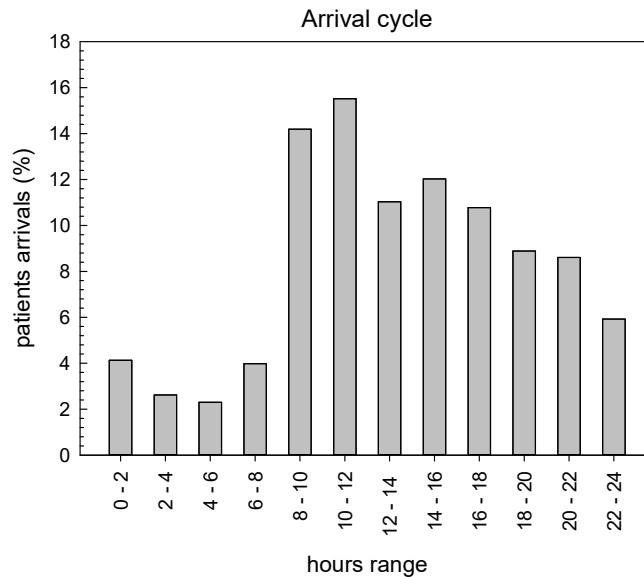

Figure 7. Percentage of Patients entering the ED hourly in normal operating conditions

The patient arrival rate during a seismic event has also been considered in the analysis, using the data collected by a Californian hospital during 1994 Northridge Earthquake [Stratton et al., 1994; Peek-Asa et al., 1998; Mc Arthur et al., 2000]. The shape of the patient seismic wave related to Northridge earthquake is available in Cimellaro et al. [2011], however in the current research the patient's arrival rate has been scaled to adapt to the seismic hazard in the region (Turin, Italy). In

particular, an earthquake with a return period of 2500 years has been considered in the analysis, assuming a nominal life for a strategic building like a hospital of 100 years according to the Italian seismic standards [NTC-08, 2008]. Initially a scaling procedure based on the PGA has been used but, because of its limitations, another procedure based on the Modified Mercalli Intensity (MMI) scale has been selected. In Figure 8 are shown three days of patient arrival rate following Northridge earthquake which has been scaled with respect to the corresponding PGA and MMI values. Then the number of patients has been grouped in different color codes, following a similar distribution proposed by Yi (2005).

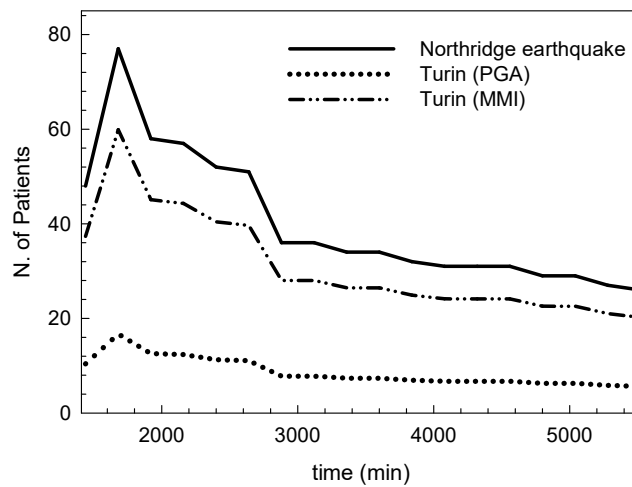

Figure 8. Arrival rates for Northridge earthquake and arrival rate scaled with respect to PGA and MMI.

4.4 Emergency plan

After a disaster occurs, the number of incoming patients rises significantly. A change in patients' arrival rates entails an increase of crowding, extend the time to be treated by an emergency provider and enhances the risk of aggravating patients' conditions. Considering all these aspects, hospitals' EDs should have an emergency plan implemented during catastrophic events. The Emergency Plan (EP) consists of a number of procedures planned to respond efficaciously to those situations in

which the normal plan would not be able to provide the essential health services. It is also developed to assure, during an emergency, adequate medical resources for the continuation of patient care, equipment, treatment materials availability and an appropriate interaction with others critical infrastructures. Generally, the EP is activated when the number of ill or injured exceeds the normal capacity of the ED to provide the quality of care required.

According to the Mauriziano hospital's provisions, the EP is activated when there is the simultaneous access (or within a short period) of 10 or more patients with critical health condition (red and yellow codes). However, according to the personnel in the hospital, this condition has never happened before. Therefore, the only possibility to test the effectiveness of the EP is using a *discrete-event simulation model* which represents a useful tool to test the response of the EP with an increasing number of incoming patients. According to the EP, the patients with critical health conditions are red and yellow codes, so in order to check if the EP can be activated the total number of red and yellow code incoming patients has been plotted in Figure 9. The figure shows the amount of patients arriving in the ED during the three days period following an earthquake with 2500 years return period. In this case, the EP threshold is exceeded, so the EP is activated.

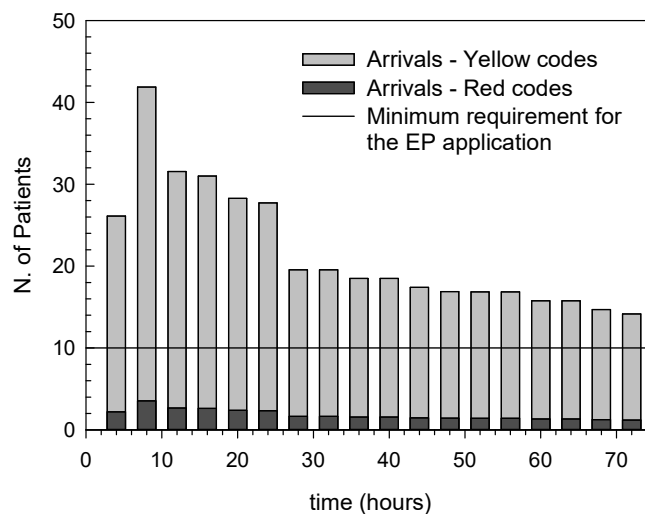

Figure 9. Total arrival rate during an emergency (red and yellow codes)

4.5 Numerical results

The model has been validated and verified by comparing the numerical results in normal operating conditions with the real data provided by the hospital. Monte Carlo simulation has been performed using 100 runs for each scenario considered. The total time of each run in the simulation is 13 days, which has been divided in three parts. First, the simulation runs for two days using the patient arrival rate in normal operating condition, to make the system stable and remove any influence by the initial conditions. Then for three days, the patient arrival rate generated by the seismic event is used. Finally, the last eight days of simulation use again the patient arrival rate in normal operating conditions, to bring back the system to the steady state it had before the earthquake occurs. The numerical output of the simulation is the patient *waiting time vs. time* divided according to the color code for different scenarios (e.g. with and without the Emergency plan, etc.). In Figure 10 is shown the average waiting time vs. time in normal and emergency operating conditions, assuming the same distribution of incoming patients.

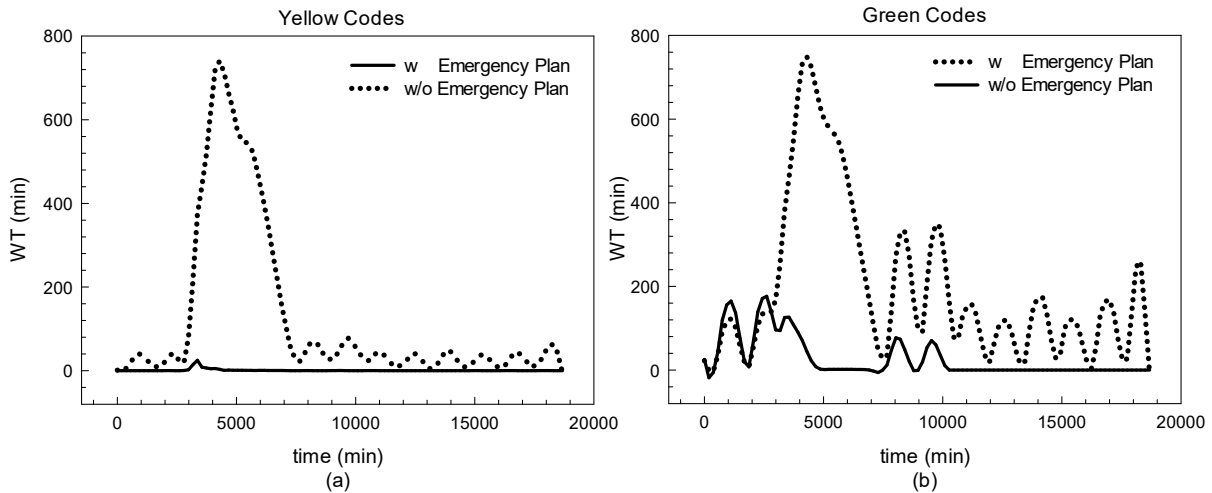

Figure 10. Comparison with and w/o Emergency Plan with MMI=VI for (a) yellow codes;
(b) green codes

The numerical results illustrate that the waiting time is significantly reduced when the emergency plan is active. The results reveal that both yellow and green code patients experience longer waiting time in normal operating conditions during an extreme situation. In particular, the average patient waiting time for yellow codes reaches a peak value of about 720 min, while for green codes of about 750 min without emergency plan. On the contrary, when the emergency plan is active, the average patients waiting time reaches a peak value of about 30 min for yellow codes and about 190 min for the green codes. In percentage, there is a reduction of waiting time of 96% for the yellow codes and of 75% for the green codes respectively, when the emergency plan is applied.

Sensitivity analysis has been performed using six different increasing levels of earthquake intensities from MMI=VI to MMI=XI. Monte Carlo simulations have been run and in Figure 11 is shown the average waiting time vs. time with and without emergency plan, assuming the same distribution of incoming patients corresponding to an earthquake with MMI=XI. The numerical results show that the effect of the emergency plan is more evident for high earthquake intensity.

In fact, the average patients waiting time for yellow codes reaches a peak value of about 3200 min, while for green codes of about 3250 min without emergency plan. On the contrary, when the emergency plan is active, the average patients waiting time reaches a peak value of about 300 min for yellow codes and about 785 min for the green codes. In percentage, there is a reduction of waiting time of 91% for the yellow codes and of 76% for the green codes respectively, when the emergency plan is applied.

Although the emergency plan plays a positive role in reducing the waiting time, the green code in emergency conditions must wait around 800 min (13 hours) when an earthquake with MMI=XI strikes. The long waiting can delay the diagnosis and the consequent treatment, leading to complications, putting patients' lives and well-being in jeopardy. Therefore, the possibility to improve the existing emergency plan in the hospital has been analyzed, by adding additional resources such as doctors and emergency rooms. The possibility of adding one doctor without

adding simultaneously the respective emergency room has also been considered, because the green codes can also receive treatment outside their emergency room.

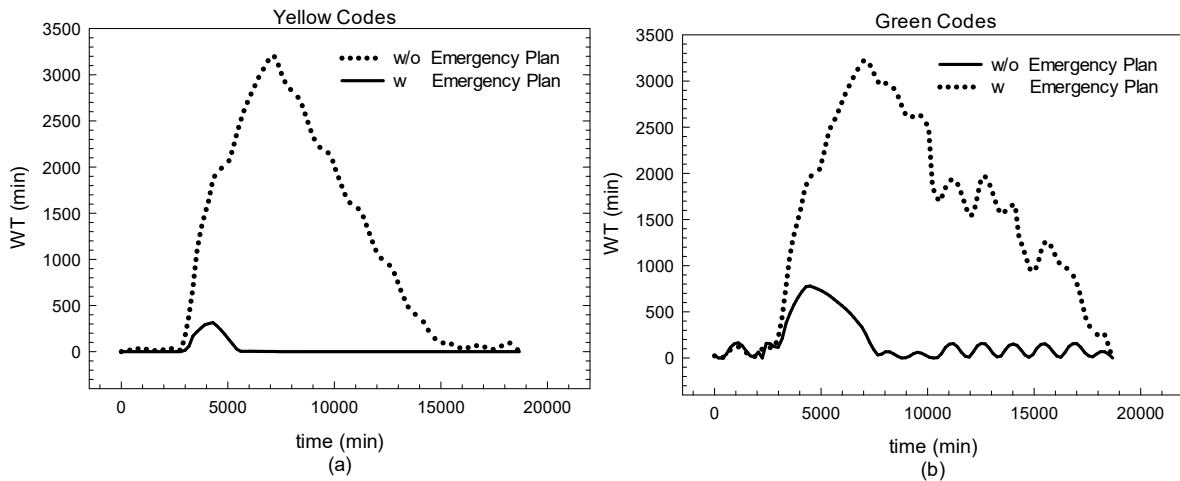

Figure 11. Comparison with and w/o EP with an amplified seismic input (MMI=XI) for (a) yellow codes; (b) green codes

The results of the sensitivity analysis by adding different resources are given in Figure 12, where is shown that, when one additional doctor is considered, the average peak of waiting times decrease of about 39%. On the other hand, if an emergency room is added, a reduction of about 74% compared with the initial emergency plan is observed. Finally, adding both a doctor and an emergency room the waiting time reduces to a peak of about 90 min, generating a total reduction of 88% with respect to the initial emergency plan (13 hours). Between the different options, the addition of an emergency room only is more feasible and recommended, also because an emergency room is already available in the ED. So it can be used by the existing personnel, at no extra cost, while in the other cases a doctor should be hired by the hospital. In fact, the solution with extra costs is not justified by a reduction of the waiting time of only 14% with respect to the recommended solution.

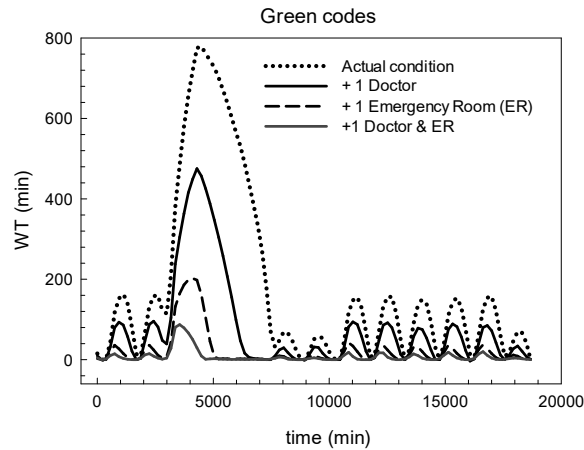

Figure 12. Sensitivity of additional resources on the performance of the ED with
Emergency Plan

5 METAMODEL FOR THE ED OF THE MAURIZIANO HOSPITAL

The proposed DES model has some limitations. First, it is computationally demanding, therefore it is difficult to run multiple simulations in real time to determine the patient waiting time during the emergency. Secondly, DES models generate a significant amount of numerical data difficult to interpret, because generally, the person who analyzes the data is not the same who built the model and, in most cases, this person has no experience with the simulation software. For the reasons above, a simplified model, called “metamodel” has been developed. The metamodel is an analytical function describing the system behavior using a reduced number of parameters with respect to the DES model.

In this paragraph, the metamodel of a complex system such as the Mauriziano Emergency Department has been built as example to explain the methodology. The input parameters of the proposed metamodel are two: the seismic arrival rate (α) and the number of not functional emergency rooms (n) due to the earthquake, while the output parameter is the patients’ waiting time (WT).

Sensitivity analysis has been performed by changing both input parameters. First, the number of ER non functional has been increased and the seismic input have been amplified. Monte Carlo simulations has been run for all the different combinations and then non linear curve regression methods have been used to identify the coefficients of the analytical quadratic equation which is issued to determine the average patient waiting time.

The main assumption of the metamodel is that has been built based on numerical simulation data obtained by the results of the DES model described in previous paragraph, so it shares the same assumptions with which the DES model has been built. It is also assumed that the configuration of the ED does not change during the emergency, so the doctors, the nurses, their paths and the emergency rooms remain the same.

Below is shown the procedure to evaluate the coefficients for the average patient waiting time of the yellow codes. A similar procedure can be followed for all the other patient codes.

5.1 Architecture of the metamodel

The general formulation of the metamodel is given by

$$WT = f(t, n, \alpha) \quad (1)$$

where WT represents the patients' waiting time, n is the number of not functional waiting rooms, α is a parameter proportional to the intensity of the seismic input and t is the time in minutes. In detail, a lognormal function has been selected to describe the average patients' waiting time which is given by

$$WT(t, n, \alpha) = \frac{a_n}{t} * \exp \left(-0.5 * \left(\frac{\ln t/b_n}{c_n} \right)^2 \right) \quad (2)$$

where a_n , b_n , and c_n are coefficients which are function of the t , n and α . All the coefficients have been calibrated using the numerical data from the DES models for both the normal and emergency operating condition.

5.2 Calibration of the model in normal operating condition

In this paragraph is described in detail the procedure to determine the coefficients, a_n , b_n , and c_n in Equation (2) for the case of patients with yellow code. First, Montecarlo simulations have been performed assuming a constant value of n and increasing values of MMI. The resulting average WT is shown in Figure 13. The trend is that by increasing the seismic input, the corresponding waiting time increases.

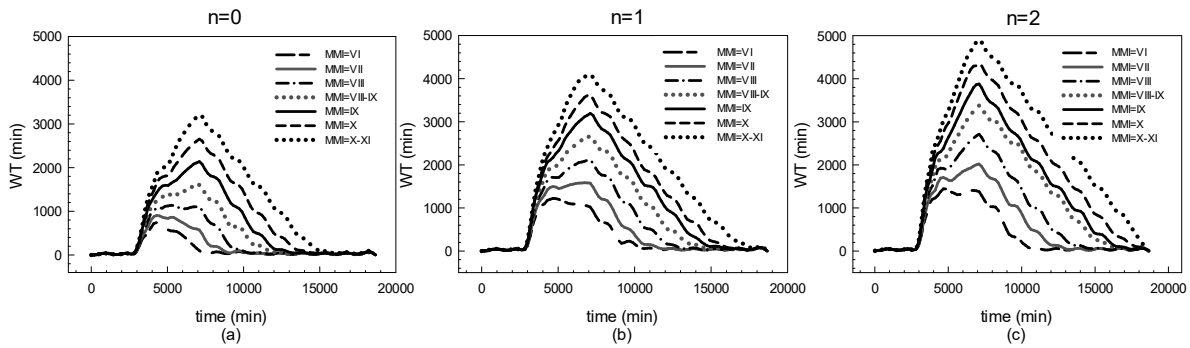

Figure 13. Simulations results w/o Emergency Plan for different values of MMI and damage states (a) $n=0$; (b) $n=1$; (c) $n=2$

Then, Montecarlo simulations have been run considering a constant value of seismic intensity (MMI) and a variable value of n . In other words, it has been simulated the closure of the emergency rooms (ER) one by one (n), assuming that a possible damage following the seismic

event makes them not functional. The results of the simulations are shown in Figure 14 for three different values of MMI. It is observed that by closing the ERs, the *WT* increase significantly. In particular, when MMI=XI and two emergency rooms are not functional, the average *WT* reaches a peak of about 5000 min, which corresponds to approximately 84 hours (three and a half days). This means that the system is congested due to a high volume of patients that exceeds the hospital capacity.

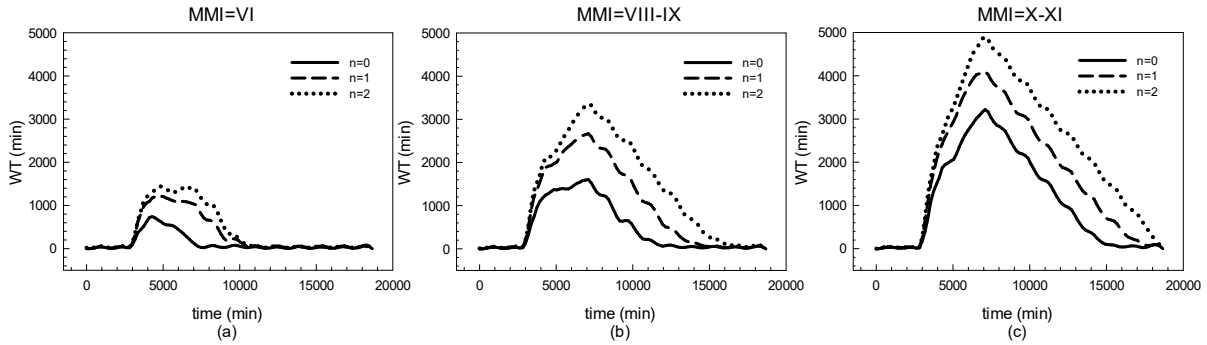

Figure 14. Simulations results w/o Emergency Plan with different damage states for (a) MMI=VI; (b) MMI=VIII-IX; (c) MMI=X-XI

In order to describe the trend shown in Figure 13 and Figure 14, the bell shape curve given in Equation (2) has been adopted where the coefficients a_n , b_n , and c_n have been determined using regression analysis assuming they are quadratic functions of α given by

$$a_n(\alpha) = a_0 + a_1\alpha + a_2\alpha^2 \quad (3)$$

$$b_n(\alpha) = b_0 + b_1\alpha + b_2\alpha^2 \quad (4)$$

$$c_n(\alpha) = c_0 + c_1\alpha + c_2\alpha^2 \quad (5)$$

where the coefficients $a_0, a_1, a_2, b_0, b_1, b_2, c_0, c_1, c_2$ are function of n and are also determined by regression analysis. The resulting quadratic functions for the case of normal operating conditions is the following

$$\begin{cases} a_0(n) = 21178533.7 - 50687867.5 \cdot n - 10938560.2 \cdot n^2 \\ a_1(n) = -49405307.7 + 86079082.9 \cdot n - 19905188.7 \cdot n^2 \\ a_2(n) = 31467171.4 - 30777131.8 \cdot n + 8057254.1 \cdot n^2 \end{cases} \quad (6)$$

$$\begin{cases} b_0(n) = -0.5166 + 1.1094 \cdot n - 0.3743 \cdot n^2 \\ b_1(n) = 1.121 - 1.529 \cdot n + 0.5132 \cdot n^2 \\ b_2(n) = -0.3514 + 0.5445 \cdot n - 0.1776 \cdot n^2 \end{cases} \quad (7)$$

$$\begin{cases} c_0(n) = -3955.3 + 3131.5 \cdot n - 1393.7 \cdot n^2 \\ c_1(n) = 11100.9 - 1821.2 \cdot n + 1262.6 \cdot n^2 \\ c_2(n) = -2328.4 + 45.4 \cdot n - 200.1 \cdot n^2 \end{cases} \quad (8)$$

5.3 Calibration of the model with the emergency plan

The same procedure described above can be used to evaluate the coefficients of the model in Equation (2) when the Emergency plan is active in the model.

Similarly, Montecarlo simulations have been performed assuming a constant value of n and increasing values of MMI. The resulting average WT is shown in Figure 15. Similar trends to the ones shown in Figure 13 have been observed, however an additional consideration can be added. The effectiveness of the Emergency plan is more evident when all the ERs are functional, while when most of them are not functional ($n=2$), the emergency plan do not have any effect in reducing the average patient waiting time.

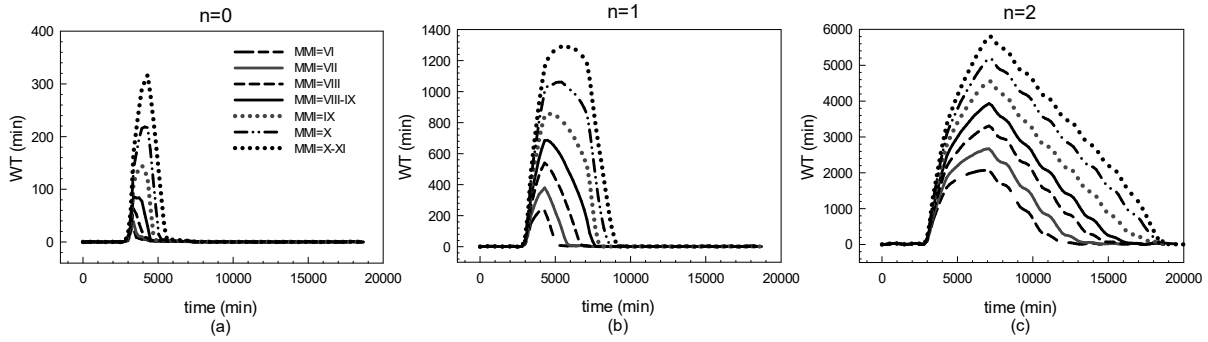

Figure 15. Simulations results with Emergency Plan for different values of MMI and damage states for (a) n=0; (b) n=1; (c) n=2

Instead by keeping constant the seismic intensity and increasing the number of non functional ERs, it can be observed that for high seismic intensities MMI=XI when two ERs are not functional, the WT can reach peaks of about 6000 min (around 4 days) (Figure 16c). This peak is even higher with respect to the same condition when the Emergency Plan is not applied (Figure 13c).

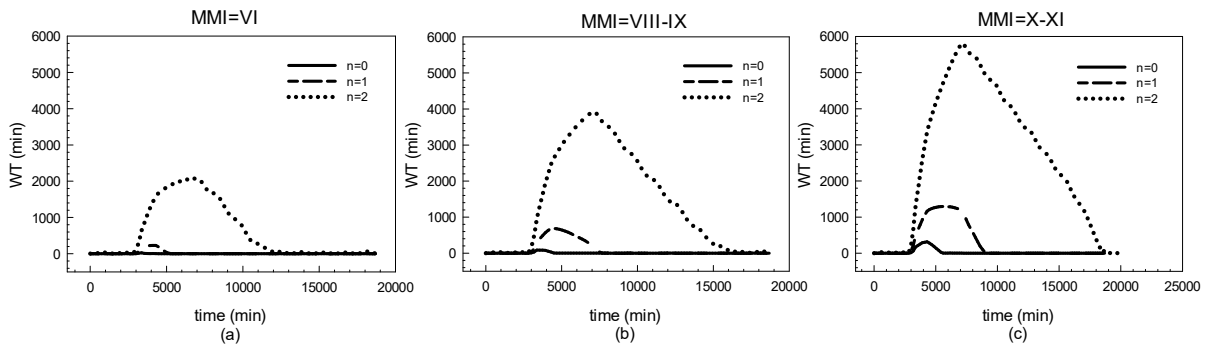

Figure 16. Simulations results with Emergency Plan with different damage states for (a) MMI=VI; (b) MMI=VIII-IX; (c) MMI=X-XI

The reason of this unexpected behavior can be explained because when the Emergency Plan is not active, there are five ERs for both the green and the yellow codes. Instead, when the EP is active 3

ERs are reserved for the yellow codes only, while the green codes are treated in different parts of the hospital. When two ERs are not functional ($n=2$) and the EP is not active, the yellow codes have three ERs available and they have priority with respect to the green codes, so it can be assumed that yellow codes use two of the three rooms available. On the other hand, when the EP is active, but two ERs are not functional, the yellow codes can be treated only in one ER. For the reasons above, the WT for the yellow codes following a high seismic intensity event (MMI=XI) is smaller when the EP is not active. Equations (3), (4) and (5) are also valid when the emergency plan is applied, but the new coefficients $a_0, a_1, a_2, b_0, b_1, b_2, c_0, c_1, c_2$ which are function of n are given by the following equations

$$\begin{cases} a_0(n) = 4313145 + 13231212.6 \cdot n - 9439291.9 \cdot n^2 \\ a_1(n) = -8170064.6 - 25095914.1 \cdot n - 14299370.7 \cdot n^2 \\ a_2(n) = 3947395.5 + 6797542.2 \cdot n + 1122876.7 \cdot n^2 \end{cases} \quad (9)$$

$$\begin{cases} b_0(n) = -0.1195 - 1.099 \cdot n + 0.6206 \cdot n^2 \\ b_1(n) = 0.1625 + 1.728 \cdot n - 0.8719 \cdot n^2 \\ b_2(n) = 0.0033 - 0.61 \cdot n + 0.3148 \cdot n^2 \end{cases} \quad (10)$$

$$\begin{cases} c_0(n) = 3304.5 - 6345.4 \cdot n + 3260.9 \cdot n^2 \\ c_1(n) = -939.3 + 8878.9 \cdot n - 3687 \cdot n^2 \\ c_2(n) = 945.1 - 2823.8 \cdot n + 1415.2 \cdot n^2 \end{cases} \quad (11)$$

After the model has been built, the numerical results have been compared with the DES model.

In Table 2 are listed the error in the estimation of the maximum waiting time between the DES model and the metamodel with and without emergency plan. The comparison shows that the metamodel is able to provide an accurate description of the ED with an error with ranges between 0.32 and 15.2% and an average value which is below 5%.

Table 2. Error in the estimation of the maximum WT between the proposed metamodel and the DES model with and w/o EP

MMI	Without Emergency Plan			With Emergency Plan		
	Error (%), n=0	Error (%), n=1	Error (%), n=2	Error (%), n=0	Error (%), n=1	Error (%), n=2
VI	5.43%	2.94%	7.53%	8.00%	9.17%	5.31%
VII	3.84%	8.96%	5.44%	15.2%	1.05%	3.71%
VIII	10.81%	4.35%	1.03%	7.93%	1.11%	0.93%
VIII-IX	2.23%	0.37%	1.11%	8.13%	5.24%	0.38%
IX	2.60%	2.72%	4.40%	6.89%	8.96%	1.63%
X	3.22%	1.35%	3.26%	7.33%	11.21%	1.92%
X-XI	0.32%	1.00%	3.92%	1.89%	9.82%	2.41%

6 GENERALIZATION OF THE METAMODEL

The main limitation of the model proposed in Equation (2) is that can only adequately represent, in real time, the dynamic response of the Mauriziano hospital's Emergency Department. Therefore, it is needed to develop a general metamodel that can be applied to any ED. However, the problem is rather complex because each ED is substantially different from the other, so it is impossible to create a general model with the same level of accuracy of a model which has been built "ad hoc" for a specific ED. So in order to have more flexibility with respect to the metamodel proposed in previous paragraph an additional parameter has been added for the calibration. In particular, the

number of parameters selected for characterizing a generic ED is three. They are the number of emergency rooms, the number of doctors and the seismic intensity.

One of the assumptions made in the general metamodel is that the total number of emergency rooms (m) is equal to the number of doctors (q). This assumption is generally reasonable because one emergency room is equipped to provide care to only one patient, so the presence of an additional doctor would be ineffective. The form of the lognormal equation of the generalized metamodel used for estimating the WT is the following:

$$WT(t, \alpha, m) = \frac{a(\alpha, m)}{t} * \exp \left(-0.5 * \left(\frac{\ln \left(\frac{t}{b(\alpha, m)} \right)}{c(\alpha, m)} \right)^2 \right) \quad (12)$$

where m is the total number of emergency rooms per color area equivalent to the total number of doctors, t is the time in minutes and a , b , c are nonlinear regression coefficients obtained using Equations (3), (4) and (5).

Instead, the coefficients $a_0, a_1, a_2, b_0, b_1, b_2, c_0, c_1, c_2$ have been expressed as function of the total number of emergency rooms m in the ED. The calibration has been performed using different DES models of the ED with increasing number of emergency rooms and increasing level of incoming patients. For all the possible combinations, several functions of the coefficients have been fitted and finally the same type of equation has been selected for all the coefficients. The coefficients of the generalized metamodel appearing in Equation (3), (4) and (5) are the following:

$$a_1(m) = 132611723 + m^4 \left(2072754 - \frac{26999059}{m} + \frac{124474864}{m^2} - \frac{233300000}{m^3} \right) \quad (13)$$

$$a_2(m) = 16657792 + m^4 \left(-543784 + \frac{6227391}{m} - \frac{22646870}{m^2} + \frac{22339458}{m^3} \right) \quad (14)$$

$$b_0(m) = 5.57 + m^4 \left(0.08 - \frac{1.04}{m} + \frac{4.89}{m^2} - \frac{9.34}{m^3} \right) \quad (15)$$

$$b_1(m) = -7.65 + m^4 \left(-0.12 + \frac{1.58}{m} - \frac{7.34}{m^2} + \frac{13.67}{m^3} \right) \quad (16)$$

$$b_2(m) = 2.79 + m^4 \left(0.04 - \frac{0.54}{m} + \frac{2.54}{m^2} - \frac{4.78}{m^3} \right) \quad (17)$$

$$c_0(m) = 28475.3 + m^4 \left(338.6 - \frac{4684.3}{m} + \frac{22726}{m^2} - \frac{43551.1}{m^3} \right) \quad (18)$$

$$c_1(m) = -43772 + m^4 \left(-578.5 + \frac{8013.6}{m} - \frac{38812}{m^2} + \frac{74209.6}{m^3} \right) \quad (19)$$

$$c_2(m) = 11604.2 + m^4 \left(123.1 - \frac{1811}{m} + \frac{9196.2}{m^2} - \frac{18167.4}{m^3} \right) \quad (20)$$

With respect to the model by Cimellaro et al. (2011) which is related to hospitals located in California, the proposed one is able to distinguish between different codes (red, yellow, green etc.), including also the intensity of the seismic input and reducing the number of parameters from three to two. These improvements of the model have been possible due to the large availability of patient's data provided by a hospital located in downtown in Turin which has been used as case study in this example and which allowed a refined calibration of the model.

6.1 Validation of the metamodel

In order to validate the proposed generalized metamodel, its numerical results have been compared with the respective DES model of the Mauriziano hospital in Turin and another hospital located in San Sepolcro, Tuscany.

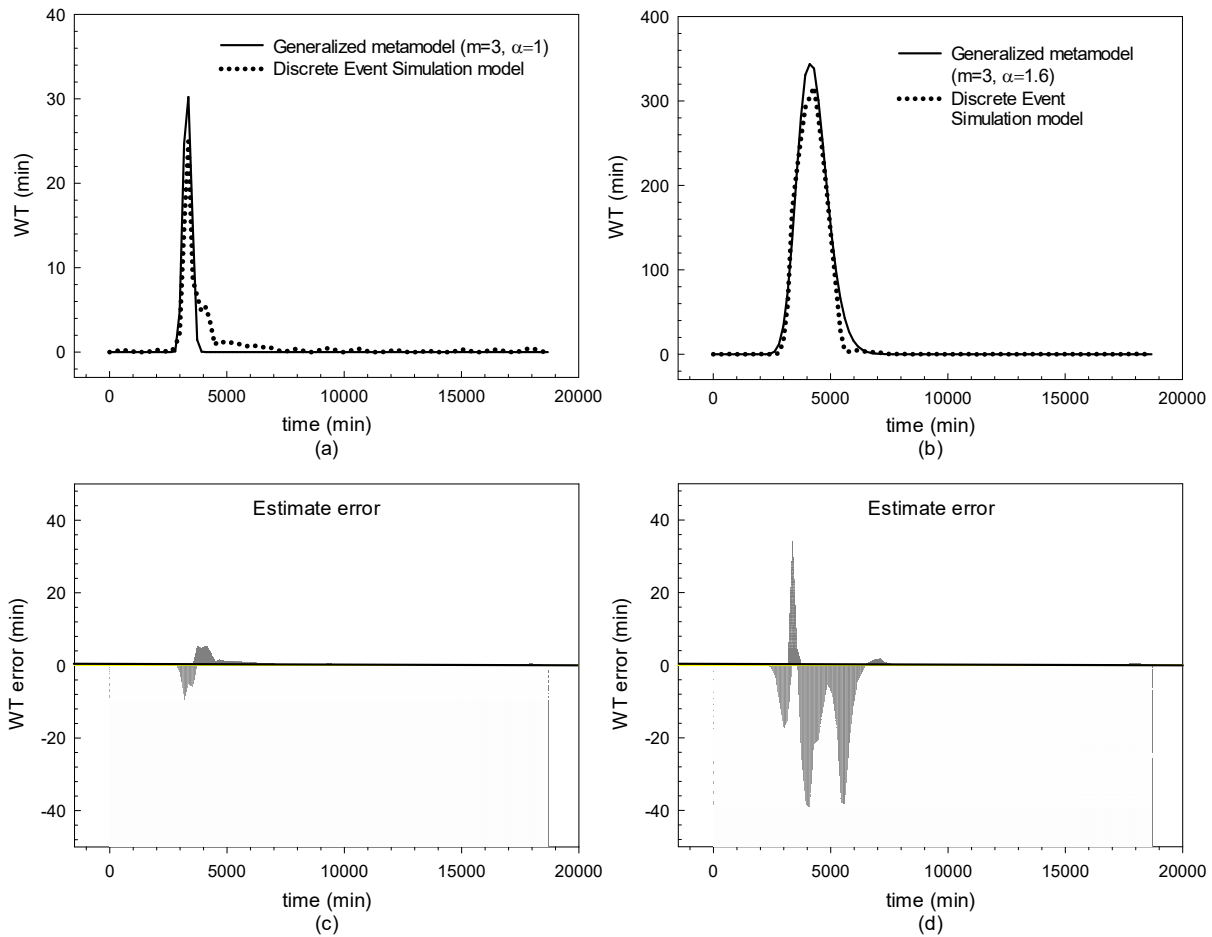

Figure 17. Comparison between metamodel and DES model of the Mauriziano's hospital for (a) MMI=VI, (b) MMI=XI; (c), (d) error bars

In Figure 17a and b is shown the comparison in term of waiting time between the generalized metamodel of the Mauriziano ED ($m=3$) with the respective DES model, for two different levels of seismic intensity, MMI=VI and MMI=XI. As observed, there is a good matching between the two models. To generalize the results, the model has also been validated using another hospital located in San Sepolcro, Tuscany that has 4 ERs ($m=4$). Similarly, the results for the same two level of seismic intensity are shown in Figure 18a and b, highlighting also in this case a good matching with

the DES model. The error in the term of maximum WT between the DES models and the generalized metamodel is given in Table 3.

Table 3. Error between the DES model and the generalized metamodel evaluated at the peak value for Mauriziano and San Sepolcro hospitals

Seismic Intensity	Error (%)	Error (%)
	Mauriziano ED	San Sepolcro ED
MMI	19.6%	10.7%
VI	16.9%	25.4%
VII	13.8%	24.3%
VIII	9.3%	21.2%
VIII-IX	17.2%	15.3%
IX	13.1%	5.1%
X	5.9%	1.7%

In this case, the maximum error in the estimation of the maximum waiting time is around 25% for the San Sepolcro hospital. From the results shown in Figure 17, Figure 18 and Table 3, it can be concluded that for both hospitals, the generalized metamodel is able to describe the ED's behavior.

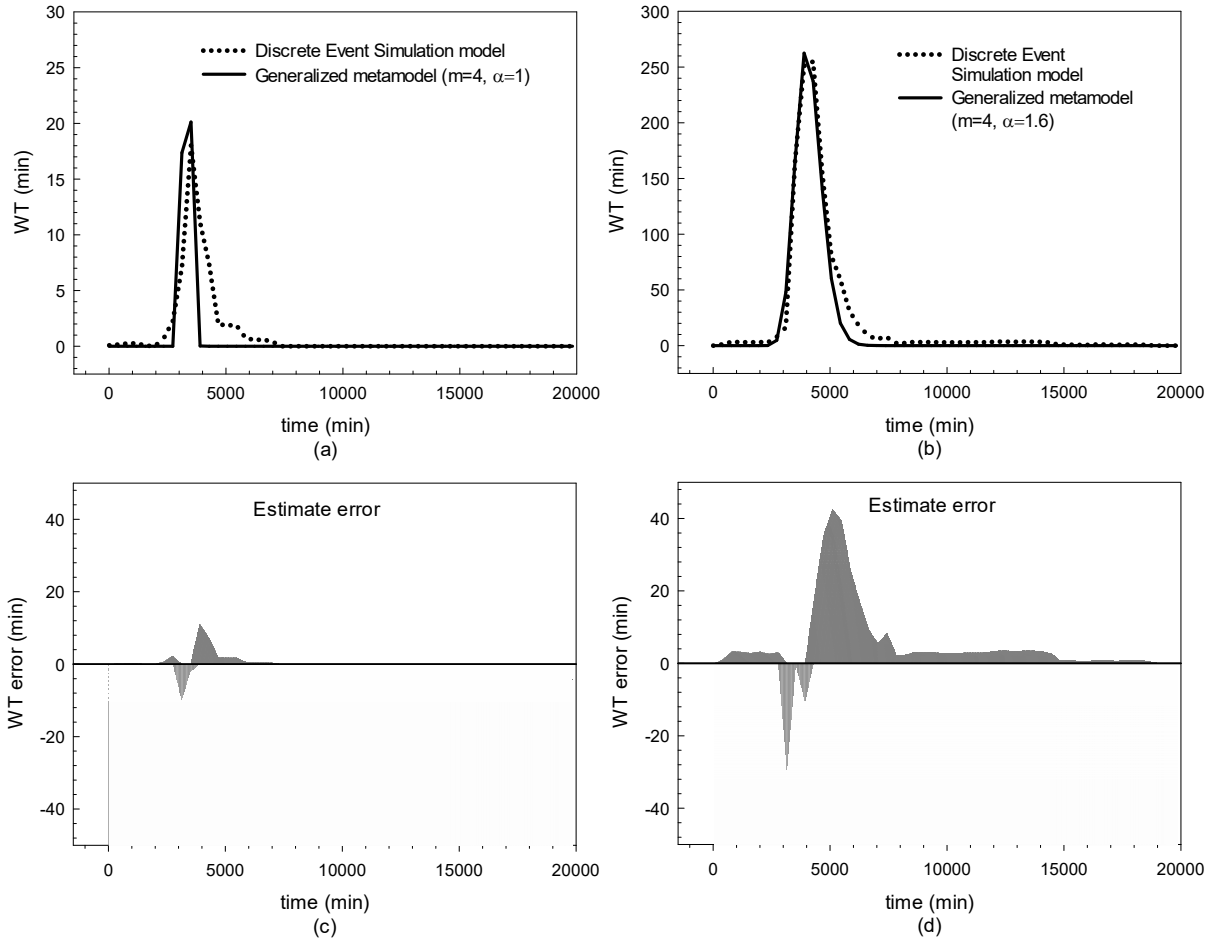

Figure 18. Comparison between analytical metamodel and San Sepolcro's experimental data for (a) $\alpha=1$, (b) $\alpha=1.6$; (c), (d) error bars

7 CONCLUDING REMARKS

Healthcare facilities play a key role in our society, especially during and immediately following a disaster. Indeed, there are many potential hazards that may occur in a geographic area so it is essential that hospitals ensure their functionality during emergencies. Therefore, during a disaster a healthcare facility must remain accessible and able to function at maximum capacity, providing its services when they are most needed. Discrete event simulation is a powerful tool to represent

complex systems such as hospitals. It has been used widely in the medical industry since the mid 80's.

In this paper, the patients' waiting time (WT) has been identified as the main parameter to evaluate the resilience indicator of an Emergency Department. A discrete event simulation model has been built for the hospital's emergency department with and without the emergency plan. Results have been collected, and the waiting times calculated when the emergency plan is applied, have been compared with the results in normal operating condition, showing the efficiency of the existing emergency plan. However, building a DES model is time consuming; therefore, a simplified model called "*metamodel*" has been developed. In order to build the metamodel, different scenarios have been considered taking in account the intensity of the seismic input and the number of functional emergency rooms. The proposed model can be used by any hospital to measure the performance of its Emergency Department without running complex simulations and for estimating its resilience to disasters. It can also be used by decision makers to measure the performance of a hospital network in real time during an emergency or to develop some pre-event mitigation actions by optimizing the resources allocated and comparing different emergency plans.

8 ACKNOWLEDGEMENTS

The research leading to these results has received funding from the European Research Council under the Grant Agreement n° ERC_IDEal reSCUE_637842 of the project IDEAL RESCUE - Integrated DEsign and control of Sustainable CommUnities during Emergencies and from the European Community's Seventh Framework Programme - Marie Curie International Outgoing Fellowship (IOF) Actions-FP7/2007-2013 under the Grant Agreement n°PIOF-GA-2012-329871 of the project IRUSAT— Improving Resilience of Urban Societies through Advanced Technologies.

REFERENCES

- Cimellaro, G. P., Reinhorn, A. M., and Bruneau, M. [2010]. "Seismic resilience of a hospital system." *Structure and Infrastructure Engineering*, 6(1-2), 127-144.
- Cimellaro, G. P., Reinhorn, A. M., and Bruneau, M. [2011]. "Performance-based metamodel for health care facilities." *Earthquake Engineering & Structural Dynamics*, 40 (11), 1197–1217.
- Curran, J., Findlay, H., Rymaszewski, L. A., and Van Der Meer, R. B. [2005]. "Using OR to support the development of an integrated musculo-skeletal service." *Journal of the Operational Research Society*, 56(2), 162-172.
- Dansky KH, and Miles, J. [1997]. "Patient satisfaction with ambulatory healthcare services: waiting time and filling time." *Hosp Health Serv Adm* 42(2), 165-77.
- Davies, R. "See and Treat" or "See" and "Treat" in an emergency department." *Proceedings of the 2007 Winter Simulation Conference*, Washington, DC, DEC 09-12, 2007, 1498-1501.
- Duda, C. I. [2011]. "Applying Process Analysis and Discrete Event Simulation to Improve Access and Customer Service Times at the Ronald Reagan UCLA Medical Center," Ph.D. Thesis, University of California, Los Angeles (UCLA), Los Angeles.
- Fetter, R. B., and Thompson, J. D. [1965]. "The simulation of hospital systems." *Operations research*, 13(5), 689 - 711.
- Günel, M. M., and Pidd, M. [2010]. "Discrete event simulation for performance modelling in health care: a review of the literature." *Journal of Simulation*, 4, 42–51.
- Hu, X. [2013]. "Optimization analysis of patient waiting time and resource utilization in an ob/gyn clinic – a simulation approach," Ph.D. thesis, University of Central Arkansas.
- Kirtland, A., Lockwood, J., Poisker, K., Stamp, L., and Wolfe, P. "Simulating an emergency department “is as much fun as...”." *Proceedings of the 1995 Winter Simulation Conference*, 1039-1042.
- Komashie, A., and Mousavi, A. "Modeling emergency departments using discrete event simulation techniques." *Proceedings of the Winter Simulation Conference*, Orlando, FL
- Lau, R. [2008]. "Applying discrete-event simulation to orthopaedic clinics: case studies and perspectives ", M.A.Sc., University of Toronto, Toronto.
- Mahapatra, S., Koelling, C. P., Patvivatsiri, L., Fraticelli, B., Eitel, D., and Grove, L. "Pairing emergency severity index5-level triage data with computer aided system design to improve emergency department access and throughput." *Proceedings of the 2003 Winter Simulation Conference*, 1917-1925.
- Martin, E., Gronhaug, R., and Haugene, K. "Proposals to reduce over-crowding, lengthy stays and improve patient care: study of the geriatric department in Norway's largest hospital." *In Proceedings of the 2003 Winter Simulation Conference*, 1876-1881.
- McArthur, D. L., Peek-Asa, C., and Kraus, J. F. [2000]. "Injury hospitalizations before and after the 1994 Northridge, California earthquake." *The American Journal of Emergency Medicine*, 18(4), 361.
- Medeiros, D. J., Swenson, E., and DeFlicht, C. "Improving patient flow in a hospital emergency department." *Proceedings of the 2008 Winter Simulation Conference*, Miami, Florida, USA, 1526-1531.
- Morales, G. [2011]. "Using discrete event computer simulation to analyze the effects of proposed changes to personnel in a hospital medical laboratory," M.S., The University of Texas - Pan American, Ann Arbor.
- Morganti, K. G., Bauhoff, S., Blanchard, J. C., Abir, M., Iyer, N., Smith, A. C., Vesely, J. V., Okeke, E. N., and Kellermann, A. L. [2013]. "The Evolving Role of Emergency Departments in the United States." *RAND*
- Morgareidge, D., CAI, H., and JIA, J. [2014]. "Performance-driven design with the support of digital tools: Applying discrete event simulation and space syntax on the design of the emergency department." *Frontiers of Architectural Research*, 3(3), 250–264.
- NTC-08. [2008]. "Nuove Norme Tecniche per le Costruzioni (in Italian)." Consiglio Superiore dei Lavori Pubblici, Ministero delle Infrastrutture, Gazzetta Ufficiale della Repubblica Italiana.

- Peek-Asa, C., Kraus, J. F., Bourque, L. B., Vimalachandra, D., Yu, J., and Abrams, J. [1998]. "Fatal and hospitalized Injuries resulting from the 1994 Northridge earthquake." *International Journal of Epidemiology*, 27(3), 459-465.
- ProModel Corporation. [2014]. "ProModel 2014 User Guide." © 2014 ProModel Corporation • 556 East Technology Avenue • Orem, UT 84097
- Samaha, S., Armel, W. S., and Starks, D. W. "The use of simulation to reduce the length of stay in an emergency department." *Proceedings of the 2003 Winter Simulation Conference*, 1876-1881.
- Santibáñez, P., Chow, V., French, J., Puterman, M., and Tyldesley, S. [2009]. "Reducing patient wait times and improving resource utilization at British Columbia Cancer Agency's ambulatory care unit through simulation." *Health Care Management Science*, 12(4), 392-407.
- Šteins, K. [2010]. "Discrete-Event Simulation for Hospital Resource Planning – Possibilities and Requirements " Ph.D. thesis, Linköping University, Norrköping, Sweden.
- Stratton, S. J., Hastings, V. P., Isbell, D., Celentano, J., Ascarrunz, M., Gunter, C. S., and Betance, J. [1996]. "The 1994 Northridge Earthquake Disaster Response: The Local Emergency Medical Services Agency Experience." *Prehospital and Disaster Medicine*, 11(3), 172-179.
- Takakuwa, S., and Shiozaki, H. [2004]. "Functional analysis for operating emergency department of a general hospital." *Proceedings of the 36th conference on Winter simulation*, IEEE Washington, D.C., Dec. 5-8, 2004 2003 - 2011
- Yerravelli, S. [2010]. "Computer simulation modeling and nurse scheduling for the emergency department at Kishwaukee community hospital " Ph.D. thesis, Northern Illinois University, Schaumburg, Illinois, 60173, United States.
- Yi, P. [2005]. "Real-time generic hospital capacity estimation under emergency situations " Ph.D. Thesis, State University of New York at Buffalo, Buffalo, NY.