

Performance evaluation of wireless power transfer systems for electric vehicles using the opposition method

Original

Performance evaluation of wireless power transfer systems for electric vehicles using the opposition method / Cirimele, Vincenzo; Rosu, STEFAN GEORGE; Guglielmi, Paolo; Freschi, Fabio. - ELETTRONICO. - (2015), pp. 546-550. (Intervento presentato al convegno IEEE International Forum on Research and Technologies for Society and Industry Leveraging a better tomorrow (RTSI 2015) tenutosi a Torino nel 16-18 Sept. 2015) [10.1109/RTSI.2015.7325155].

Availability:

This version is available at: 11583/2639270 since: 2020-06-26T12:01:55Z

Publisher:

IEEE

Published

DOI:10.1109/RTSI.2015.7325155

Terms of use:

This article is made available under terms and conditions as specified in the corresponding bibliographic description in the repository

Publisher copyright

(Article begins on next page)

Performance evaluation of wireless power transfer systems for electric vehicles using the opposition method

Vincenzo Cirimele* , Stefan George Rosu† , Paolo Guglielmi* , Fabio Freschi*

*Politecnico di Torino, Department of Energy
Corso Duca degli Abruzzi, 24, 10129 Torino, Italy
Email: vincenzo.cirimele@polito.it

†University “Politehnica” of Bucharest
Department of Applied Electronics and Information Engineering
Splaiul Independentei 313, 060032 Bucharest, Romania

Abstract—The present paper proposes the use of the opposition method to evaluate the performance of a wireless power transfer system. The work is focused on the effect related to the insertion of conductive or ferromagnetic components that are materials typically adopted in the realization of this kind of systems.

Index Terms—Inductive power transmission - Loss measurement - Mutual coupling - Resonant inverters - Wireless power transmission

I. INTRODUCTION

The research interest in the inductive transmission of electric power, simply indicated as IPT (inductive power transfer) or, in the recent, as WPT (wireless power transfer), has rekindled in the last decade. This technology has been involved in several industrial applications where there is the necessity to supply a movable component without the rigidity of a fixed electric contact. It has been used to deliver power to movable objects such as monorail trolleys [1], [2], in particular environments with potential risks of explosion that could be caused by electric sparks or in other application, like underwater supplies, where the conventional conductive methods have some difficulties [3].

In the last years this technology has started to be interesting for the market of electric vehicles (EV). Many electric vehicle manufacturers consider this technology a good way to promote the market penetration of electric vehicles thanks to its characteristics of safety derived by the absence of electric contacts and simplicity in the daily use. The typical power range in these cases starts from 2 kW and reaches some hundreds of kW as function of the vehicle battery characteristics and the recharge time [4], [5].

The aim of this paper is to propose the use of the *opposition method* [6] to estimate the performances of these systems without the necessity of a source that has to supply the full power. The measurements are conducted for different setups considering the insertion of an aluminum shield and ferrite cores. These materials are typically adopted in this applications

to improve the magnetic coupling and to protect human beings from the magnetic field exposure.

The paper is organized as follows. Section II briefly introduces the symbols, the basic theory of WPT and the adopted circuit model. The opposition method and the test setup are described in Section III. Section IV shows the results of the experimental test of the proposed setup. Finally some concluding remarks and some proposals for future work are given in Section V.

II. INDUCTIVE WIRELESS POWER TRANSFER FUNDAMENTALS

The WPT is based on the magnetic coupling of two coils. For the EV charging application, there is one coil on ground named transmitter and one named receiver installed under the vehicle.

The circuit model describing the WPT system is represented in Fig. 1. R_1, R_2 and L_1, L_2 represent the resistances and the self-inductances of the two coils while M is their mutual inductance. \underline{V}_1 models the first harmonic of the voltage source that supplies the transmitter and its output current is indicated with \underline{I}_1 . The load resistor R_L is the equivalent resistance of the recharging circuit of a battery [2] expressed as:

$$R_L = h_c \frac{V_{\text{batt}}}{I_{\text{batt}}} = h_c \frac{V_{\text{batt}}^2}{P_{\text{batt}}} = \frac{V_L}{I_2} \quad (1)$$

where V_{batt} and I_{batt} represent the DC voltage and current of the battery, V_L and I_2 are the rms values of the first harmonic of voltage and current at the input of the power electronic stage linked to the receiver. The coefficient h_c is used to take into account the structure of the power electronic. In the case of a simple diode bridge rectifier, h_c equals $\pi^2/8$.

The set of equations that describes the model is

$$\underline{V}_1 = (R_1 + j\omega L_1) \underline{I}_1 - j\omega M \underline{I}_2 \quad (2)$$

$$j\omega M \underline{I}_1 = (R_2 + j\omega L_2 + R_L) \underline{I}_2 \quad (3)$$

Equation (2) is associated to the transmitter while equation (3) is associated to the receiver. The first term of (3) is called *open-circuit voltage* and defined as

$$\underline{V}_{oc} = j\omega M \underline{I}_1 \quad (4)$$

It represents the e.m.f. that appears at the receiving coil when the current \underline{I}_1 flows in the transmitter.

Expressing the equation (3) as function of \underline{I}_2 , it is possible to substitute this current in the (2) obtaining an expression in which the only current is \underline{I}_1 . This means that it is possible to find an impedance that puts in relation the transmitter voltage \underline{V}_1 and the transmitter current \underline{I}_1 . This impedance is called *total impedance* and indicated as Z_T . Its expression is provided in (5).

$$Z_T = \frac{\underline{V}_1}{\underline{I}_1} = (R_1 + j\omega L_1) + \left(\frac{\omega^2 M^2}{R_2 + j\omega L_2 + R_L} \right) \quad (5)$$

Z_T is one of the main parameters in the description of a WPT system because it provides the description of the behavior of the input current with respect to the voltage source.

Stated this, it is possible to express the transmitted power S_2 as

$$\begin{aligned} S_2 &= V_{oc} I_2 = V_{oc} \frac{V_{oc}}{\sqrt{(R_2 + R_L)^2 + (\omega L_2)^2}} = \\ &= \frac{\omega^2 M^2}{\sqrt{(R_2 + R_L)^2 + (\omega L_2)^2}} I_1^2 \end{aligned} \quad (6)$$

Equation (6) shows that the self-inductance L_2 limits the current I_2 limiting then the power transfer capability. The same happens for the current I_1 and the inductance L_1 as visible in (5).

Such limitation is the reason that drive to the insertion of compensation capacitances in order to compensate the voltage drop over the self inductances of the two coils. Usually these two capacitances are selected in order to resonate at an unique frequency for both side creating a resonant inductive power transfer [7].

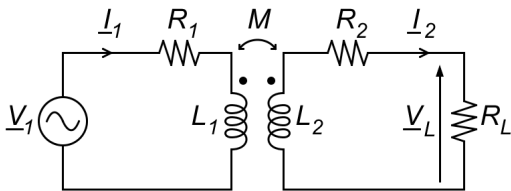

Fig. 1: Circuit model of coupled inductors with equivalent resistive load.

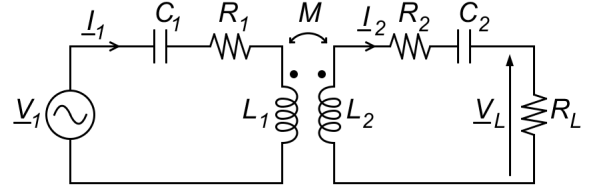

Fig. 2: Equivalent model of the series-series compensated WPT system

There are a lot of possibilities to place the capacitors starting from the basic insertion in parallel or in series respect to the related coil [4], [8] arriving to the creation of more complex compensation networks [5].

The research efforts of the authors of the present work are oriented to the use of the WPT for the charge of electric vehicles. In this case the series compensation is selected because it allows to maintain the resonance condition independently by the coupling between transmitter and receiver leading the power managed by the supply to be purely active. Furthermore, the use of the series capacitor for the transmitting coil allows the transmission of high level power without the necessity for the power electronic to manage huge voltages. All these aspects are well discussed in [7], [8].

With the insertion of the compensation capacitors, the equivalent circuit becomes like the one depicted in Fig. 2. The related expression of the total impedance becomes

$$Z_T = R_1 + j\omega L_1 + \frac{1}{j\omega C_1} + \frac{\omega^2 M^2}{R_2 + R_L + j\omega L_2 + \frac{1}{j\omega C_2}} \quad (7)$$

For a frequency equal to the resonance one, defined as

$$f_0 = \frac{1}{2\pi\sqrt{L_1 C_1}} = \frac{1}{2\pi\sqrt{L_2 C_2}} \quad (8)$$

the two capacitors compensate the inductive impedance of the respective coil. This means that the total impedance can be expressed as in (9) where the resistances of the coils are considered negligible.

$$Z_T \approx \frac{\omega^2 M^2}{R_L} \quad (9)$$

Eq. (9) implies that, at the resonance, Z_T becomes purely resistive which means that the transmitted power and the power supplied by the source become purely active. This leads to an additional benefit of this topology related to the design of the resonant system: the reduction of the VA rating of the power electronic inverter and then related costs, volumes and efficiency.

III. PROPOSED TESTING METHOD

This paper proposes the use of the *opposition method* as a technique to evaluate the performance of the WPT system.

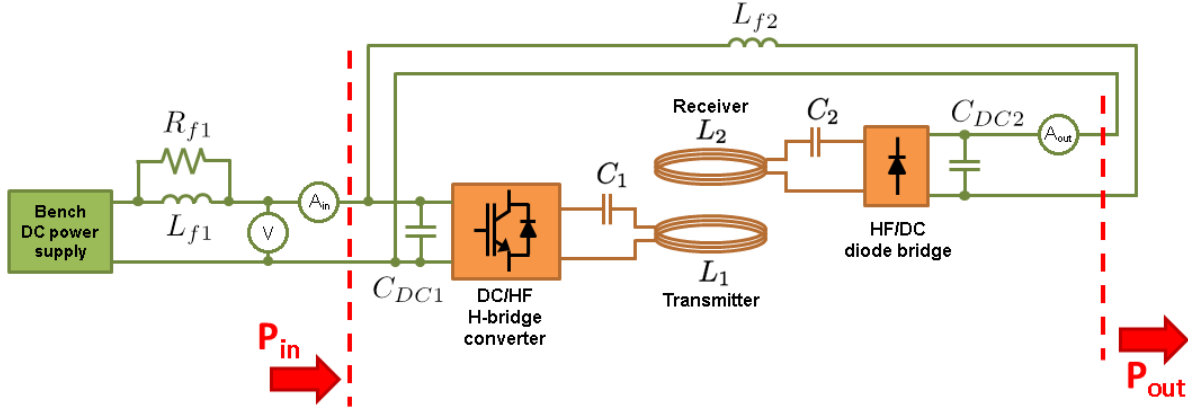

Fig. 3: Test setup for the implementation of the opposition method for a WPT system

In this case it consists of a closed loop where the DC output of the diode bridge that manages the power of the receiver is connected to the same DC bus of the converter that generates the high-frequency voltage that supplies the transmitter. In this way, if the bus voltage is the nominal one, the system can be tested at nominal power while the DC supply has to compensate only for the system losses. This means that the size of the DC supply becomes small compared with the power of the WPT system under test. Furthermore this technique provides for an useful method to evaluate the losses of the system. Thanks to the fact that the voltage at the system input and the voltage at the system output are the same, it is sufficient to measure the DC currents to have the measurements of the transmitted power and the overall efficiency.

The proposed setup for the test is depicted in Fig. 3.

In general, the application of this method needs for a strong inductive filtering in the interconnection of the two DC stages in order to minimize the interferences of the two equivalent voltage source, but, in this case, just a small inductor (L_{f2}) is sufficient thanks to the current source behavior of the receiver.

The demonstration of the current source behavior can be simply derived expressing the receiver current I_2 as a function of the open-circuit voltage as:

$$I_2 = \frac{V_{oc}}{R_L} = \omega M I_1 \frac{1}{R_L} \quad (10)$$

It is possible to substitute the relation (9) to eliminate the dependency by the transmitter current obtaining the following relation:

$$I_2 = \frac{V_1}{\omega M} \quad (11)$$

Eq. (11) indicates that, if the coupling is maintained constant and the system works at an imposed transmitter supply voltage, the receiver current is independent of the receiver voltage, i.e. the receiver behaves like a current source.

IV. EXPERIMENTAL RESULTS

One of the main advantages of the opposition method is that the input and output powers can be measured through DC current and voltage values, easily reaching a very good accuracy.

In real implementations the system efficiency is affected by the presence of materials in the proximity of the coils, like shielding and ferrite, the impact of the presence or absence of such materials is here studied.

In order to validate the proposed testing method the adopted WPT system used is described by the parameters specified in Table I. The transmitter supply system is an IGBT H-bridge.

Four cases are considered: without shield and without ferrite, without shield and with ferrite, with shield and without ferrite, with shield and with ferrite. The parameters in Table I are for the first case. For the other three cases, the capacitors have been modified in order to keep the resonance frequencies equal (137.5 kHz).

The effect of the insertion of the aluminum shield and ferrite cores is represented with FEA simulations in Fig. 4. The magnetic field distribution is modified significantly by the shield. In order to concentrate the field far from the shield and reduce the losses, a small number of ferrite bars are placed on two sides of the rectangular coils.

The test system with the coils and compensation capacitors for the case with shield and with ferrite is presented in Fig. 5. The measurement instrumentation consists of three Fluke 175 true-rms multimeters, one for the DC voltage and two for the input and output currents as indicated in Fig. 3.

The measured output power and the DC supplied power are presented in Fig. 6 where it is evidenced the different power level managed by the WPT system under test and the one provided by the DC supply.

The efficiency can be calculated directly as the ratio of the DC output current and the sum of this current and the one supplied by the DC supply.

The measured efficiency of the WPT system is presented in Fig. 7a. At the resonant frequency, the best efficiency is

TABLE I: Values of the parameters of the system under test

Parameter	Value	
Transmitter inductance	L_1	90.8 μH
Transmitter series capacitance	C_1	14.7 nF
Receiver inductance	L_2	89.9 μH
Receiver series capacitance	C_2	14.9 nF
DC supply voltage	V_{DC}	27.9 V
Output diode bridge filter capacitor	$C_{\text{DC}2}$	6 μF
Filter inductance at the interconnection	L_{f2}	200 μH
Output DC supply filter inductance	L_{f1}	1 mH
Output DC supply damping resistance	R_{f1}	33 Ω
DC bus capacitor	$C_{\text{DC}1}$	6 μF

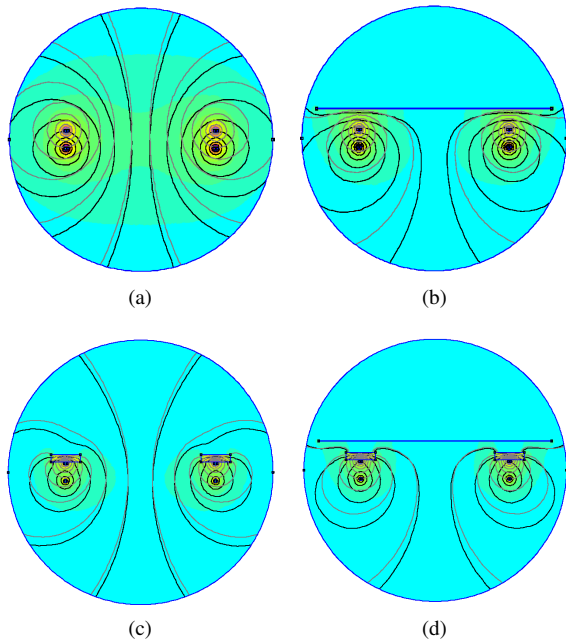
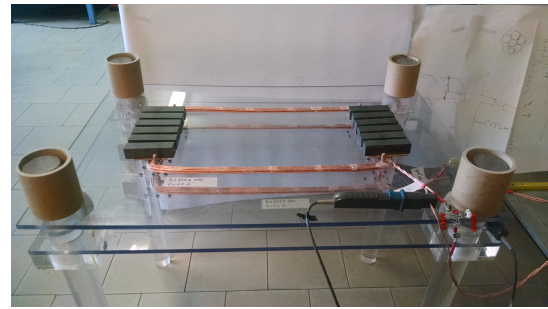

Fig. 4: Effect of the insertion of aluminium shield and ferrite cores on the magnetic field distribution. Air coupling (a), aluminium shield insertion (b), ferrite cores insertion (c), aluminium shield and ferrite cores (d).

given by the case without shield and with ferrites because of lower losses and higher coupling between the primary and secondary. The addition of a small quantity of ferrite has a positive impact on the power transmission efficiency with respect to the cases without ferrite. Because of higher losses in the H-bridge converter, the efficiency decreases just below the resonant frequency. The transferred power is plotted in Fig. 7b. There is a significant variation in the transmitted power at the resonant frequency because of variations in the components values. It is worth mentioning that the used components have a 10% tolerance. This tolerance implies that the resonance



(a)



(b)

Fig. 5: Setup of the system under test. Insertion of ferrite cores (a). Presence of aluminium shield (b)

frequencies of the transmitter and the receiver are not equal, this way the converter is characterized by a double resonance [4]. The result of such difference is that the power transfer is asymmetrical with respect to the nominal resonance frequency. In Fig. 7b the receiver resonance frequency is higher than the one of the transmitter. This effect is accentuated for low coupling between the transmitter and receiver, as in the test case without shield and without ferrite. In order to verify the obtained results, another measurement has been performed with adjusted capacitors in order to have the same resonant frequency in the transmitter and in the receiver. The output

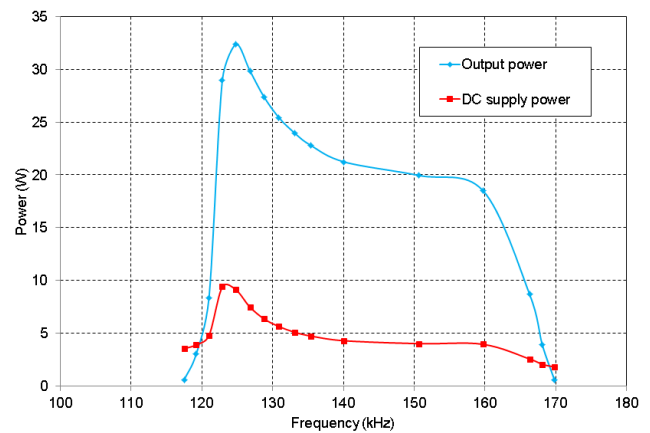
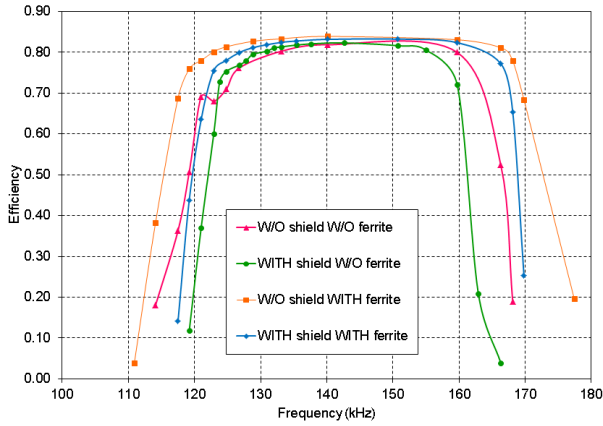
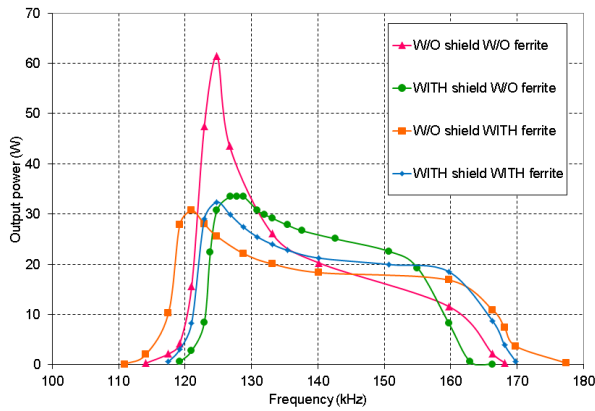

Fig. 6: Power flowing in the WPT system under test with the opposition method

power in Fig. 8 is symmetric with respect to the resonant frequency. The sensitivity to the parameter variations could be minimized with a variable frequency control [9].



(a)



(b)

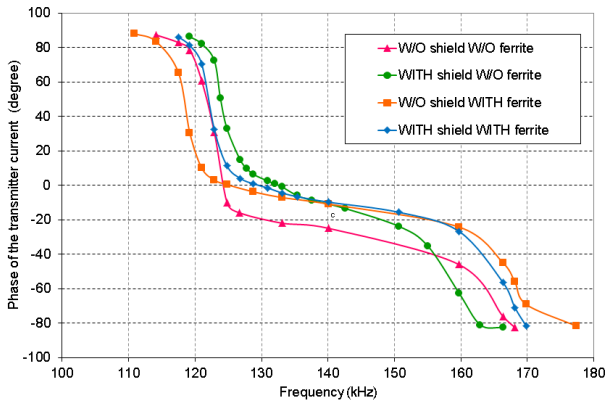

(c)

Fig. 7: Comparison of performance for different system arrangements. Efficiency (a), transferred power (b), transmitter current phase (c).

V. CONCLUSIONS

In this paper the use of the opposition method for the analysis of the performance a WPT system has been proposed

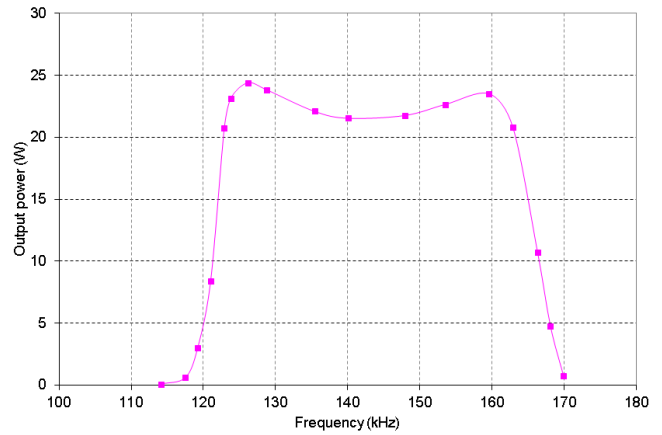

Fig. 8: Transferred power in the symmetrical case

and implemented. This method has been used to evaluate the effect of the insertion of conductive and ferromagnetic materials in the power transmission efficiency. It is concluded that the insertion of ferrite helps to reduce the losses caused by the use of an aluminum shield. The effect of unbalancement caused by the tolerances of the capacitors has been identified during the tests, it has been here briefly presented but the effects on the power transmission and its influence on the WPT system control will be object of future work.

REFERENCES

- [1] A. W. Green and J. T. Boys, "An inductively coupled high frequency power system for material handling applications", *International Power Electronics Conference, IPEC 1993*, Singapore, pp.821-826, 1993.
- [2] Myunghyo Ryu, Honnyong Cha, Younghwan Park, and Juwon Baek, "Analysis of the Contactless Power Transfer System using Modelling and Analysis of the Contactless Transformer", *31st Annual Conference of IEEE IECON 2005*, 2005.
- [3] Z. Cheng, Y. Lei, K. Song, and C. Zhu, "Design and Loss Analysis of Loosely Coupled Transformer for an Underwater High-power Inductive Power Transfer System", *IEEE Transaction on Magnetics*, issue 99, 2014.
- [4] M. Ibrahim, L. Pichon, L. Bernard, A. Razek, J. Houivet, and O. Cayol, "Advanced Modeling of a 2-kW SeriesSeries Resonating Inductive Charger for Real Electric Vehicle", *IEEE Transaction on Vehicular Technology*, vol. 64, Issue 2, page. 421-430, 2015.
- [5] A. Pevere, R. Petrella, C.C. Mi, and Shijie Zhou, "Design of a high efficiency 22 kW wireless power transfer system for EVs fast contactless charging stations", *IEEE International Electric Vehicle Conference (IEVC)*, page. 1-7, 2014.
- [6] F. Forest, J.-J. Huselstein, S. Faucher, M. Elghazouani, P. Ladoux, T.A. Meynard, F. Richardeau, and C. Turpin, "Use of opposition method in the test of high-power electronic converters", *IEEE Transaction on Industrial Electronics*, vol. 53, no. 2, pp. 530-541, 2006.
- [7] C.S. Wang, G.A. Covic, and O.H. Stielau, "Power Transfer Capability and Bifurcation Phenomena of Loosely Coupled Inductive Power Transfer Systems", *IEEE Transaction on Industrial Electronics*, vol. 52, no. 5, pp. 1308-1314, 2005.
- [8] J. Sallan, J.L. Villa, A. Llombart, and J.F. Sanz, "Optimal Design of ICPT System Applied to Electric Vehicle Battery Charge", *IEEE Transactions on Industrial Electronics*, vol. 56, no. 6, pp. 2140-2149, 2009.
- [9] F. Lu, H. Hofmann, J. Deng, and C. Mi, "Output power and efficiency sensitivity to circuit parameter variations in double-sided LCC-compensated wireless power transfer system", *Proceedings of IEEE Applied Power Electronics Conf. Expo.*, pp. 597-601, 2015.