

RFID tags and reader to measure physical parameters in glacial environment

Original

RFID tags and reader to measure physical parameters in glacial environment / Lucianaz, Claudio; Greco, Giampaolo; Bertoldo, Silvano; Allegretti, Marco; Perona, Giovanni Emilio. - STAMPA. - (2015). (Intervento presentato al convegno III Convegno Nazionale CINFAI tenutosi a Rovereto (TN) nel 14-15 Ottobre 2015).

Availability:

This version is available at: 11583/2620106 since: 2015-10-19T08:08:39Z

Publisher:

Published

DOI:

Terms of use:

This article is made available under terms and conditions as specified in the corresponding bibliographic description in the repository

Publisher copyright

(Article begins on next page)

RFID tags and reader to measure physical parameters in glacial environment

C. Lucianaz, G. Greco, S. Bertoldo, M. Allegretti, G. Perona
claudio.lucianaz@polito.it

TAG DESIGN

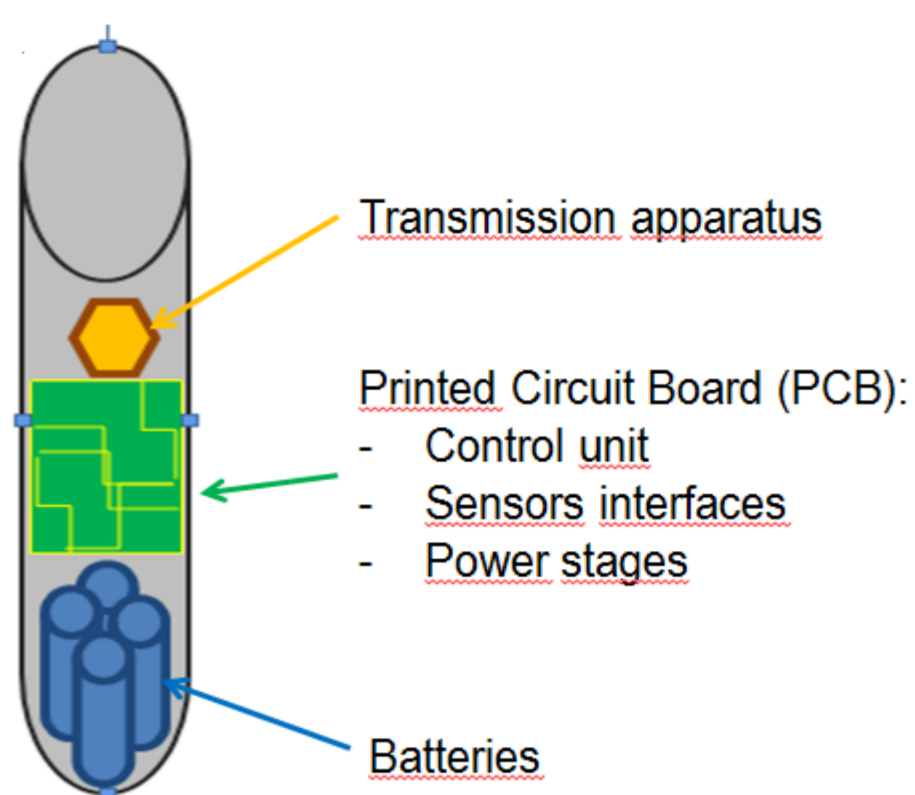

20 cm x 3.5 cm



EXAMPLE OF APPLICATION

✗ Sensore

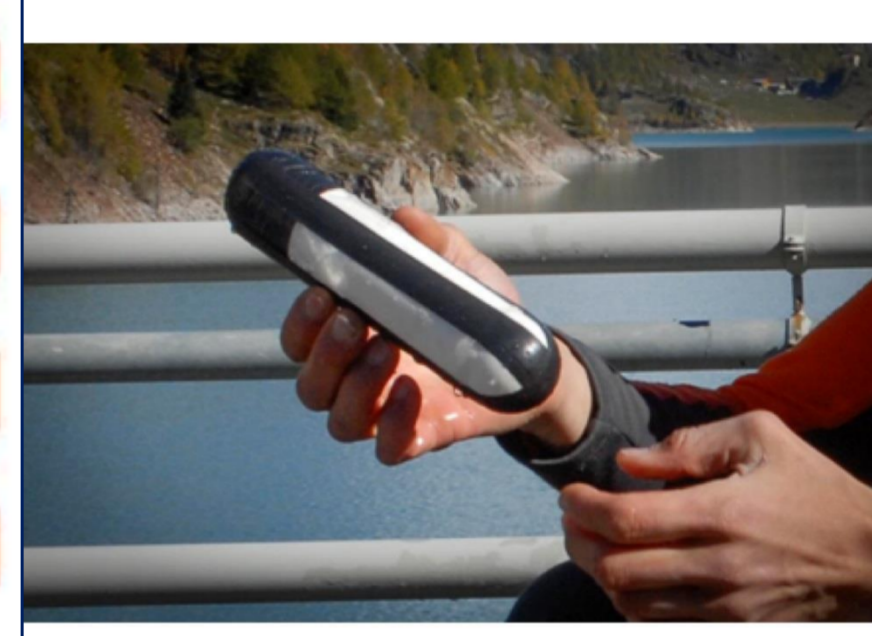
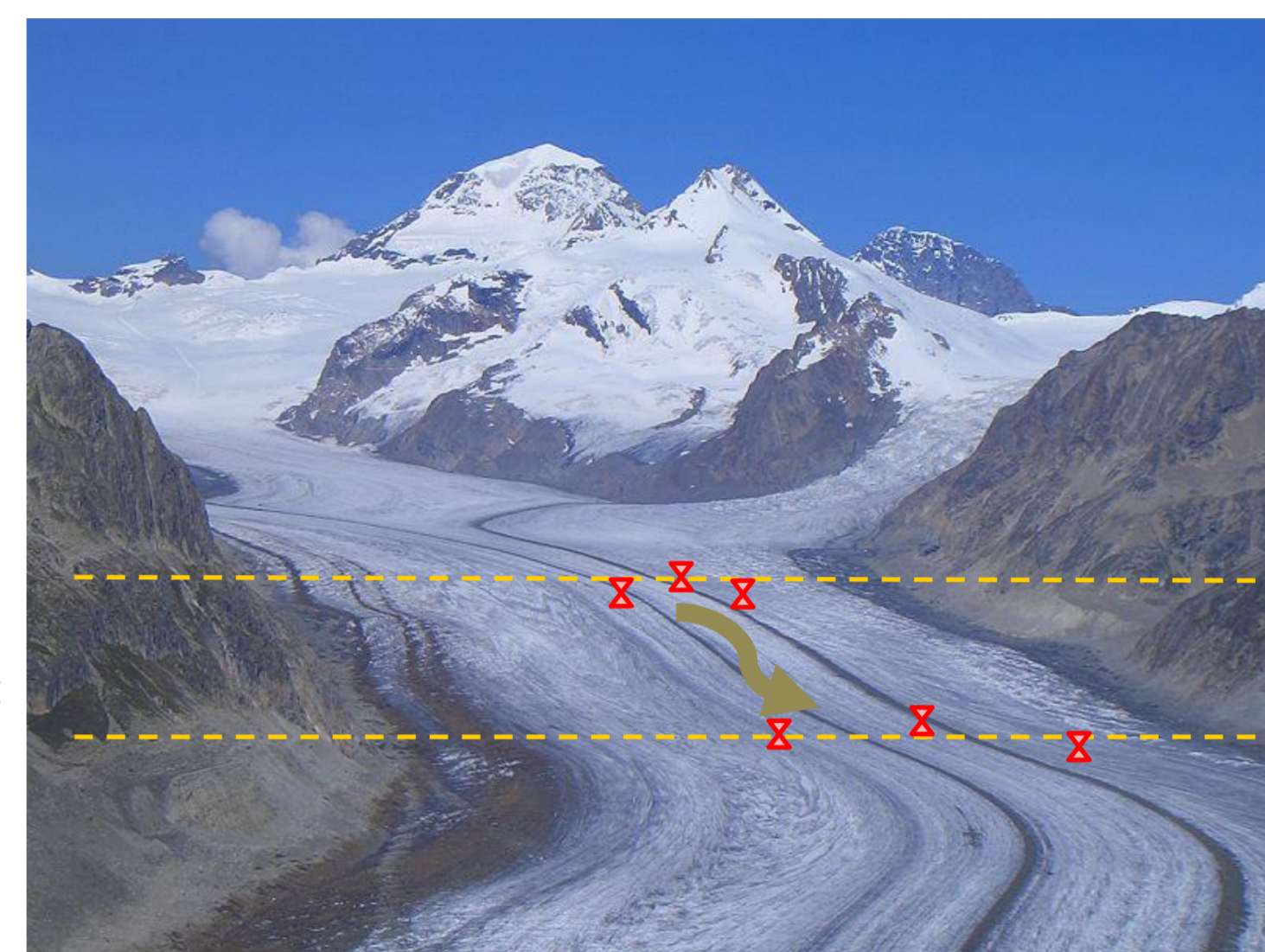

Tag



Reader with USB for laptop connection

SYSTEM DESCRIPTION

Capsule

- Accelerometer
- Magnetometer
- Temperature sensor
- Pressure sensor
- Battery
- Printed Circuit Board (PCB)
- Antenna
- Microcontroller
- Flash memory

CHARACTERIZATION TESTS

1. Test of capsule impermeability, mechanical strength, transparency to electromagnetic waves

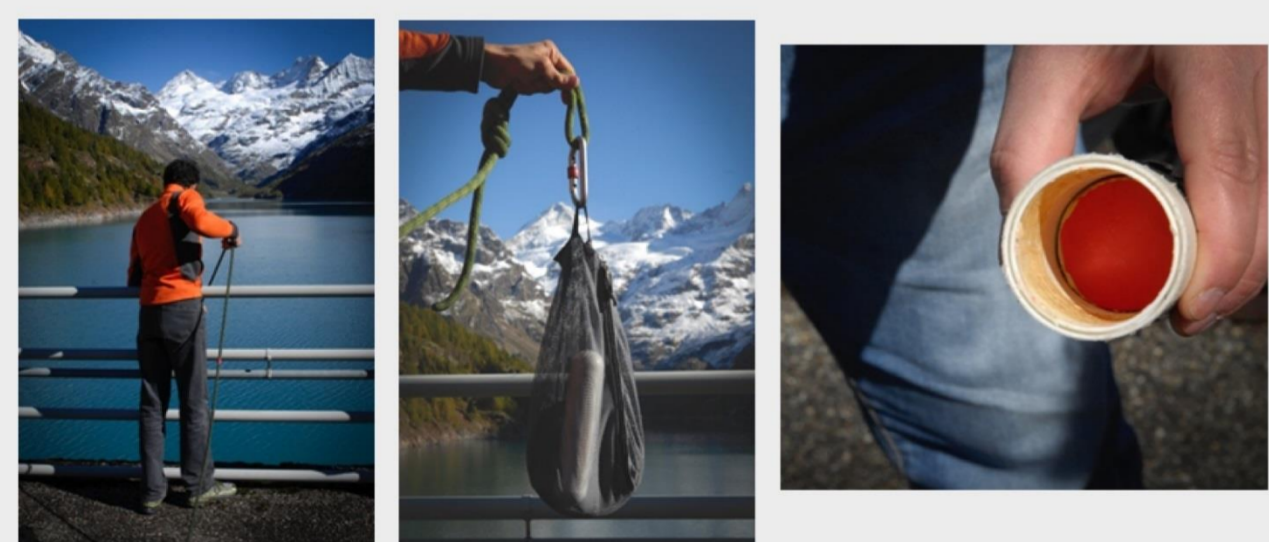

2. Signal strength measurement in free space

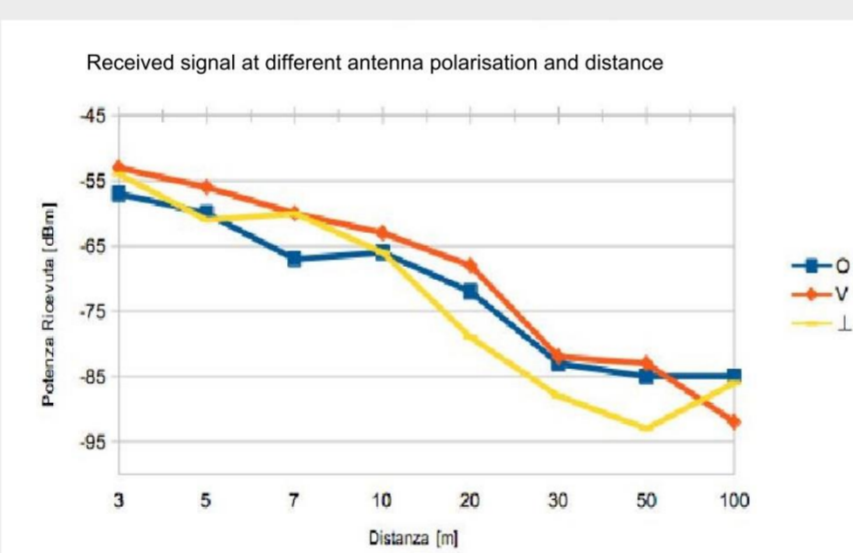

3. Radio frequency measurements through the detection of the RSSI (Received Signal Strength Indicator) in air, snow, ice

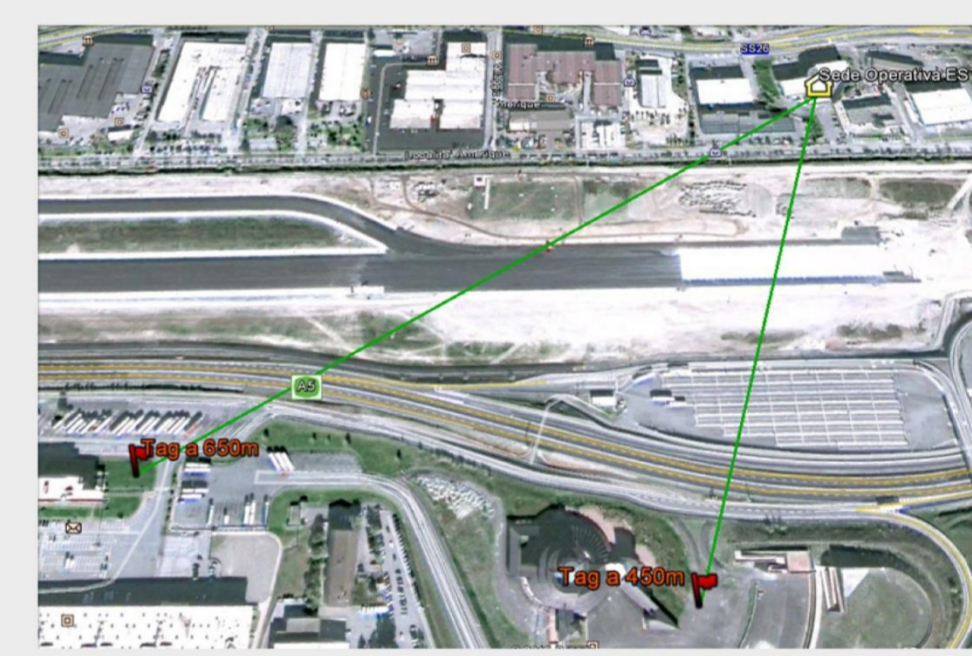

4. Power link estimation over free air

5. Characterization of temperature sensor in environmental chamber

FIELD TEST

Installation: capsule with tag+sensors at ground surface
Measured parameters: temperature (bottom of snowpack), pressure - hourly; RSSI - daily.
Control measures (manually executed): temperature (air, bottom of snowpack) - daily; snow depth - daily; snow density - weekly.

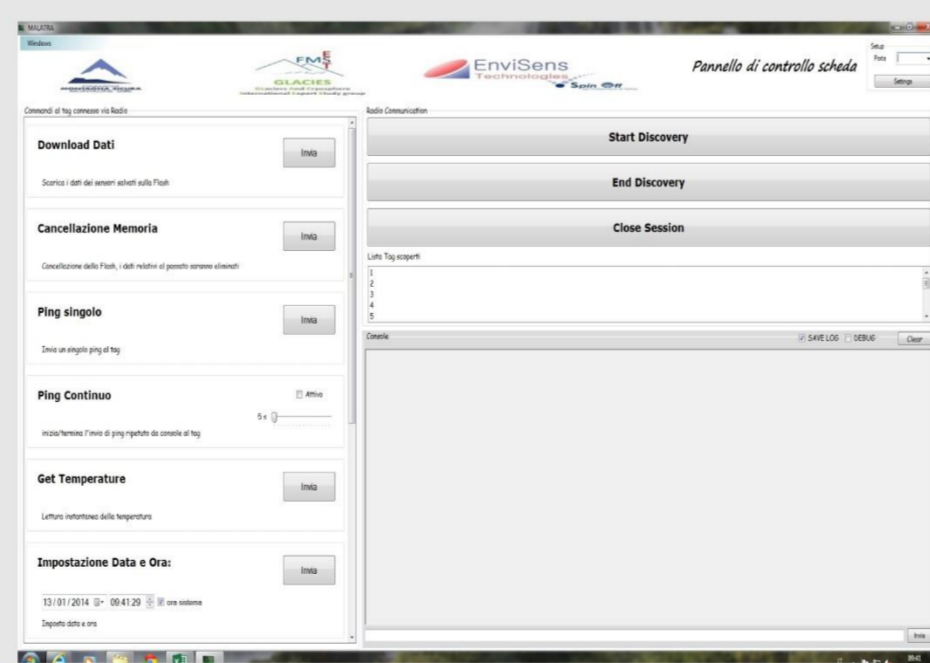

graphic interface that allows communication between reader and tag

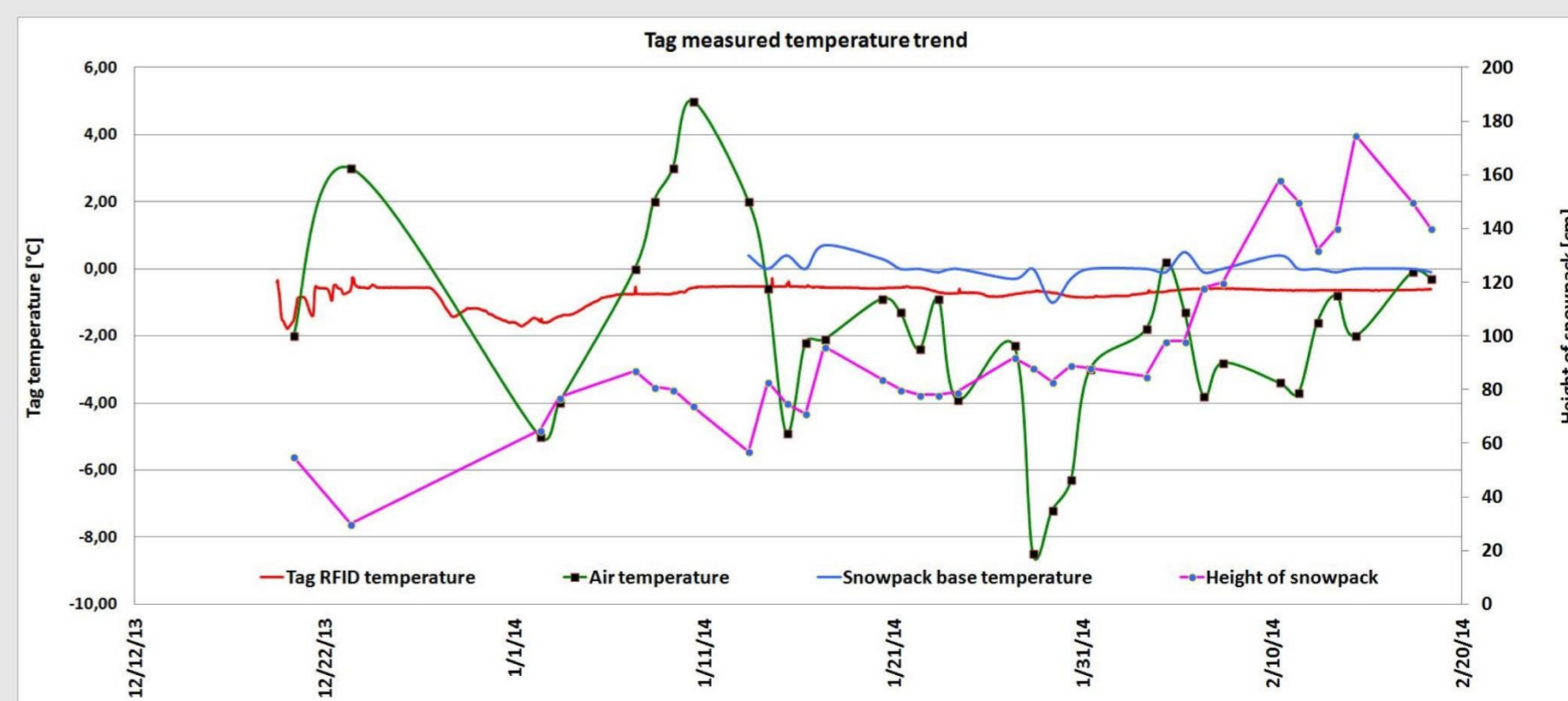

Temperature at the base of snowpack has a trend similar to air temperature until the thickness of snowpack is lower than 60 cm. When the cover increase, the temperature is stable and equal to about 0,6°C, according to manual measurements.

REF N. 1: O. Rorato et. al. , *An ad-hoc RFID tag for glaciers monitoring*, IEEE APWC 2014, Palm Beach, Aruba, 3 – 9 August 2014, pp. 864-867

REF N. 2: C. Lucianaz et. al., *RFID technology applied to glacial environment: MALATRA electronic system design and experimental data*, International Symposium on Contribution of Glaciers and Ice Sheets to Sea Level Change, Chamonix (FRA), 26-30 May 2014