

Contrast Enhancement in Polymeric Electrochromic Devices
Encompassing Room Temperatu

Original

Contrast Enhancement in Polymeric Electrochromic Devices
Encompassing Room Temperatu

re Ionic Liquids / Simone, Zanarini; Garino, Nadia; Nair, JJEESH RAVI; Francia, Carlotta; Pawel Jerzy Wojcik, ; Luis, Pereira; Elvira, Fortunato; Rodrigo, Martins; Bodoardo, Silvia; Penazzi, Nerino. - In: INTERNATIONAL JOURNAL OF ELECTROCHEMICAL SCIENCE. - ISSN 1452-3981. - ELETTRONICO. - 9:(2014), pp. 1650-1662.

Availability:

This version is available at: 11583/2577937 since:

Publisher:

ESG

Published

DOI:

Terms of use:

This article is made available under terms and conditions as specified in the corresponding bibliographic description in the repository

Publisher copyright

(Article begins on next page)

Contrast Enhancement in Polymeric Electrochromic Devices Encompassing Room Temperature Ionic Liquids

Simone Zanarini^{1*}, Nadia Garino², Jijeesh Ravi Nair¹, Carlotta Francia¹, Pawel Jerzy Wojcik³, Luis Pereira³, Elvira Fortunato³, Rodrigo Martins³, Silvia Bodoardo¹, Nerino Penazzi¹

¹Dipartimento di Scienza Applicata e Tecnologia, Politecnico di Torino, C.so Duca degli Abruzzi 24, 10129 Turin, Italy.

²Istituto Italiano di Tecnologia, Center for Space Human Robotics @Polito, C.so Trento 21, 10129, Turin, Italy.

³CENIMAT/I3N, Departamento de Ciência dos Materiais, Faculdade de Ciências e Tecnologia, FCT, Universidade Nova de Lisboa, and CEMOP-UNINOVA, 2829-516 Caparica, Portugal.

*E-mail: simone.zanarini@unibo.it

Received: 20 November 2013 / Accepted: 18 December 2013 / Published: 2 February 2014

We report the preparation and spectro-electrochemical characterization of electrochromic devices (ECD) combining inkjet-printed WO₃ as cathode and electro-deposited V₂O₅ as anode. ECD were prepared for the first time with an optimized formulation of gel polymer electrolyte based on Bisphenol A ethoxylate dimethacrylate and Poly(ethylene glycol) methyl ether methacrylate (BEMA/PEGMA) encompassing the Room Temperature Ionic Liquid (RTIL, 1-Ethyl-3-methylimidazolium bis(trifluoromethylsulfonyl)imide) as solvent. The UV-VIS spectrum of ECD was recorded at different potentials during Li⁺ insertion and de-insertion; additionally the Percent Transmittance (T%) of ECD vs. time was investigated during repeated bleaching and coloring cycles allowing thus the estimation of switching times and device stability. Due to the lower ionic conductivity and the apparent superior solvent permeability within WO₃ active layer, RTIL containing ECD showed slower switching times, but higher contrast with respect to the similar ones with EC/DEC as solvent. These results indicate that the ECD containing environment-friendly RTIL electrolytes are suitable for applications requiring high contrast, high safety and moderately fast switching times.

Keywords: Electrochromic Devices; Polymer Electrolytes; Room Temperature Ionic Liquids; Tungsten Oxide, Vanadium Oxide.

1. INTRODUCTION

In the last years electrochromic (EC) materials attracted considerable attention for their possible application in various types of optical devices such as intelligent windows and smart displays.

Electrochromism is the property of a material to change its color in a reversible way when biased at low potential; the change of the absorption spectrum is associated with an electrochemical reaction involving low size ions insertion/de-insertion in the active material [1]. Electrochromic materials can be used for example in smart windows, to lower the energy consumption in buildings or in smart displays; compared to LCD Electrochromic Device (ECD) does not need the support of a backlight due to its high visibility and reflective contrast ratio. Practical EC materials are generally inorganic oxides that can be categorized in two main groups: those with colored state formed under ions insertion (cathode) and those with colored state obtained during ions de-insertion (anode). Many transition metal oxides (W, Ir, Mn, Co, V) have been studied for their electrochromic behavior and are often preferred to the organic materials for their superior lifetime [1]. Tungsten oxide (WO_3) has been one of the first and more widely studied materials [2,3,4]. In particular, solution processed WO_3 in the form of Peroxopolytungstic acid (PTA) revealed very recently its potentiality as a very promising material for ink formulations [5]. The counter electrode is in general considered as one of the limiting factors of ECD [6]. Vanadium oxide (V_2O_5) is a promising counter electrode material in ECD because has been already successfully used in lithium batteries cathodes and changes colour during Li^+ -ion insertion. V_2O_5 based thin films can be prepared by various techniques [6], such as sol-gel, electrodeposition and PVD techniques [7]. The optimization of the process parameters can lead to different nanostructures affecting the device performances [8-11].

One of the fundamental factors affecting the ECD switching time is the selection of an appropriate electrolyte. Liquid electrolytes exhibit low stability, high flammability and low safety thus limiting the ECD range of application. To address the above mentioned issues, solid polymer electrolytes have been suggested for the application in EC devices [12]. Actually, polymeric electrolytes present several advantages as good contact with the electrodes, simple preparation procedures, low production costs and good mechanical properties [13]. Additionally polymeric electrolytes can be obtained with improved safety, stability and reliability. Thermo-set membranes obtained by UV-induced free-radical photo-polymerization technique are an interesting possibility as the preparative process has an excellent versatility [14, 15, 16].

In the present work optimized methacrylate-based polymer electrolytes (PE) [15], prepared by in situ UV curing technique, were integrated with appropriate EC electrodes [17]. As shown elsewhere the PE show a suitable ionic conductivity at room temperature [18-22].

Room Temperature Ionic Liquids (RTILs) are salts with very low melting point, so that they are liquid at room temperature. RTILs present a wide electrochemical stability window and high thermal stability. Considering their properties RTIL are thus very promising for power sources applications due to their high safety and the high ionic conductivity achieved in the polymeric electrolyte [22-24]. Recently, the use of ionic liquids as electrolyte component in ECD has been reported [23], showing the enhanced stability of all-organic ECD. RTIL have also been employed as plasticizer in PEO based electrolytes for ECD to increase Li^+ -insertion reversibility and device lifetime [16].

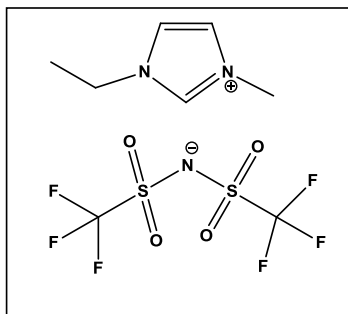

Figure 1. Structure of the Room Temperature Ionic Liquid employed in the present work.

By following the recent progresses in the field, in this work ECD devices are prepared with an optimized gel polymer electrolyte based on Bisphenol A ethoxylate dimethacrylate and Poly(ethylene glycol) methyl ether methacrylate (BEMA/PEGMA) encompassing for the first time as solvent the RTIL 1-Ethyl-3-methylimidazolium bis(trifluoromethylsulfonyl)imide (see Figure 1). The target of the present work is to obtain environment-friendly ECD with high contrast and acceptable switching times.

2. METHODS AND MATERIALS

2.1. Electrodes preparation

Substrates. ITO coated PET (Polyethylene Terephthalate, Sigma-Aldrich, $R=60 \Omega/\text{sq}$, $T > 75 \%$ at 550 nm) or ITO coated glass (Sigma-Aldrich, $R= 25 \Omega/\text{sq}$) were used as conductive substrates. All the slides were carefully rinsed with ethanol and acetone and dried prior to use.

WO₃/ITO Cathodes Preparation by InkJet Printing. Peroxopolytungstic acid (PTA) was synthesized according to a previously reported procedure [5]. The tungsten metal monocrystalline powder (Aldrich, 0.6-1 μm , 99.9 %) was carefully added to 50 ml of mixture (50:50 v:v) of distilled water (Millipore) and hydrogen peroxide (Sigma-Aldrich, 30 % by weight). The solution was cooled and kept under slow stirring for 24 hours in a refrigerator to prevent the thermal changes due to the strong exothermic nature of dissolution. The excess of tungsten powder was then removed by filtration (Roth, 0.45 μm syringe filter) leading to a transparent solution. In order to remove the excess of hydrogen peroxide the solution was dried at 65° C and washed several times with distilled water. After drying the final product was a water soluble WO₃·xH₂O₂·yH₂O orange crystal powder (PTA). The ink composition based on solvent with isopropyl alcohol to water ratio of 0.3:0.7 by weight containing 20 wt % of PTA and 3 wt % of Triton X-100 (JT Baker Chemical) exhibited the viscosity and surface tension values of 2 cP and 33 dyne cm⁻¹ respectively, acceptable for inkjet printing using a conventional office printer. Printable sol-gel precursor was filtered through a 0.45 μm pore size filter (Roth, syringe filter) leading to a transparent yellowish solution. Single layers (1 cm²) were printed 5 times using conventional desktop printer (Canon PIXMA IP4850) in regular intervals of around 1 min while being exposed to a relative humidity of 50 %, at 28 °C on ITO-PET substrates. All films were

dried at room temperature for 24 h and then annealed in air at 120 ° C (EHRET, TK4067, Germany) for 1h. The typical thickness of porous WO_3 films on ITO-PET substrates used as cathodes in this work, estimated by SEM cross sections, was of ca. 1.5 μm (see Figure 2). The printed area was successively delimited by an adhesive PET film that served as spacer during polymer electrolyte deposition.

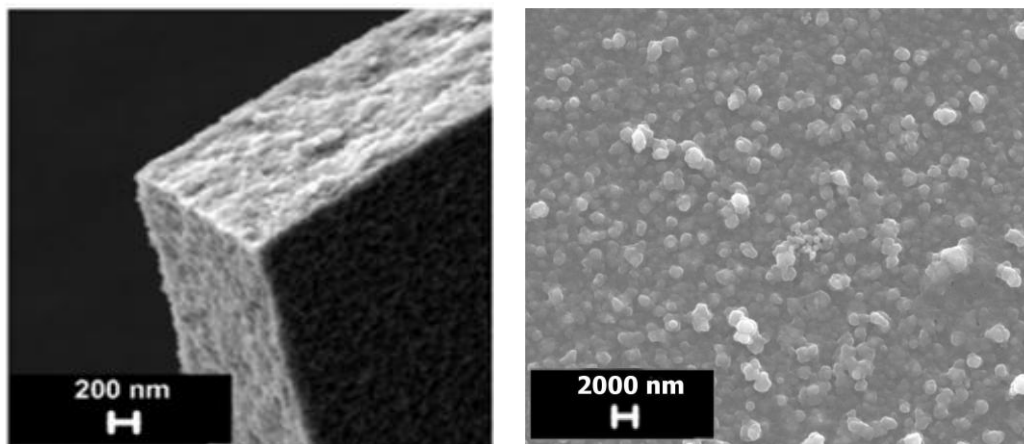

Figure 2. (Left) SEM picture showing the typical aspect and surface morphology of the WO_3 film inkjet-printed on ITO-PET substrates; (Right) SEM image showing the template-mediated micro-porous structure of electro-deposited V_2O_5 thin films on ITO (Adapted from Reference 25).

Typical Cyclic voltammogram of WO_3 inkjet-printed on ITO substrate is shown in Figure 3. The shape and position of oxidation and reduction peaks are in good agreement with the literature [1].

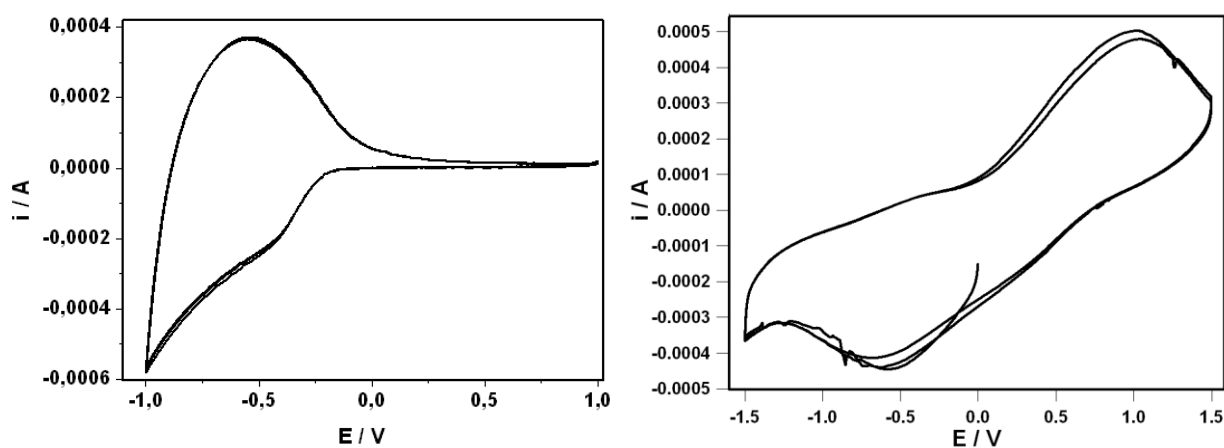

Figure 3. (Left) Typical Cyclic Voltammetric Curve of WO_3 inkjet printed on ITO-PET (Cathode) in 1 M LiClO_4 Propylene Carbonate (PC); (Right) characteristic Voltammogram of V_2O_5 electro-deposited on ITO (Anode) in LiNO_3 0.1 M ethanolic solution (Adapted from Reference 25). Scan rate: 200 mV/s. Electrodes Configuration: WO_3 or V_2O_5 on ITO as working electrode, Pt wire as counter and $\text{Ag}/\text{AgCl}/\text{KCl}$ as reference electrode.

V₂O₅/ITO Anodes Preparation by Electrochemical Deposition. V₂O₅, most likely in the H₃VO₄ or V₂O₅.xH₂O form as suggested by the presence of –OH vibrations in the FTIR spectrum [25] was deposited on ITO anodes by an electrochemical method. 0.16 g of VOSO₄·3H₂O were dissolved in a 1:1 v/v water/ethanol solution (8 ml). The suspension stability was assured by the addition 0.16 g of non ionic surfactant (P123, Sigma-Aldrich) acting also as templating agent for the porosity of deposit [8]. ITO/PET foils were cut into pieces of appropriate size and transferred to the deposition solution bath; ITO/PET sheets were used as working electrode and a Pt foil was used as counter and reference electrode. EC films over the ITO/PET were obtained by applying a positive potential for few seconds in galvanostatic conditions (current density of 1 mA/cm², T= 20 °C) [8]. After the deposition, the anodes were soaked in ethanol for 10 minutes to remove the residual surfactant and subsequently dried in air for 6 h. Transparent and uniform yellow coatings were clearly visible at the conducting surface of the working electrode by naked eye. Different coloration intensities were obtained by varying the deposition time (5-60 s). The typical thickness of V₂O₅ films on ITO, used as anodes in this work, estimated by SEM cross sections (not shown), was of ca. 2 μm. The deposition area was designed by an adhesive PET film, that served also as mold and spacer during the polymer electrolyte deposition (see section 2.3) to obtain a cathode-anode separation of ca. 300 μm.

The cyclic voltammetry of V₂O₅ electrodeposited on ITO in 1 M LiTFSI Propylene Carbonate is shown in Figure 3; a SEM image showing the typical micro-porous structure of V₂O₅ thin films prepared in this work is reported in Figure 2 [25].

The shape and position of oxidation and reduction peaks for V₂O₅ and WO₃ thin layers on ITO are in good agreement with the literature confirming thus the successful preparation of electrochromic oxides and the occurrence of Li⁺ intercalation in cathodic and anodic material [1].

2.2 Polymer electrolyte preparation

The reactive formulation for the preparation of the polymer electrolyte membranes was based on Bisphenol A ethoxylate (15 EO/phenol) dimethacrylate (BEMA) [22], a methacrylic-based di-functional oligomer having an average molecular weight of 1700, obtained from Aldrich. Poly(ethylene glycol) methyl ether methacrylate (PEGMA, Mn = 475, Aldrich) was used as reactive diluent [12,22]. Bis(trifluoromethane)sulfonimide lithium salt (LiTFSI, CF₃SO₂NLiSO₂CF₃, battery grade), obtained from Ferro Corp. (USA), was used as the Li⁺ ions source. The room temperature ionic liquid 1-Ethyl-3-methylimidazolium bis(trifluoromethylsulfonyl)imide (RTIL from Sigma Aldrich, Figure 1) was used as solvent. For comparison purposes the more conventional 1:1 w/w ethylene carbonate–diethyl carbonate (EC/DEC, battery grade, Ferro Corp., USA) mixture was alternatively used as solvent. 2-hydroxy-2-methyl-1-phenyl-1-propanone (Darocur 1173/D1173) provided by Ciba Specialty Chemicals was used as the free radical photo-initiator. Before their use, BEMA, PEGMA and D1173 were kept open for several days in the inert atmosphere of a dry glove box (MBraun Labstar, O₂ and H₂O content < 0.1 ppm) filled with extra pure Ar 6.0, and also treated with molecular sieves (Molecular sieves, beads 4 Å, 8–12 mesh, Aldrich) to ensure the complete removal of traces of water/moisture from the liquid monomers.

The polymer electrolyte membrane (PE) was prepared by mixing the monomer BEMA, PEGMA, RTIL or EC/DEC, LiTFSI and D1173 in 20:10:57:10:3 respectively. A complete insulation between cathode and anode was obtained by a 0.3 mm thick PET bi-adhesive spacer fixed between electrodes by compression. This set up was then UV irradiated for 3 min under the inert atmosphere of flowing nitrogen. This procedure also delivered a sealed system which was well protected from the ambient air conditions. The photochemical curing was performed using a medium vapour pressure Hg lamp (Helios Italquartz, Italy), with a surface radiation intensity of 30 mW cm^{-2} .

2.3. ECD with gel-polymer electrolyte assembly

The ECD were assembled manually adopting the following procedure; the cathode was first positioned horizontally with the active WO_3 layer facing up. Successively a 0.3 mm thick bi-adhesive PET spacer, masked to leave only the circular 1 cm diameter active electrodes area uncovered, was positioned on top of the cathode then the V_2O_5 anode was set on the top and glued by pressure as summarized in Figure 4.

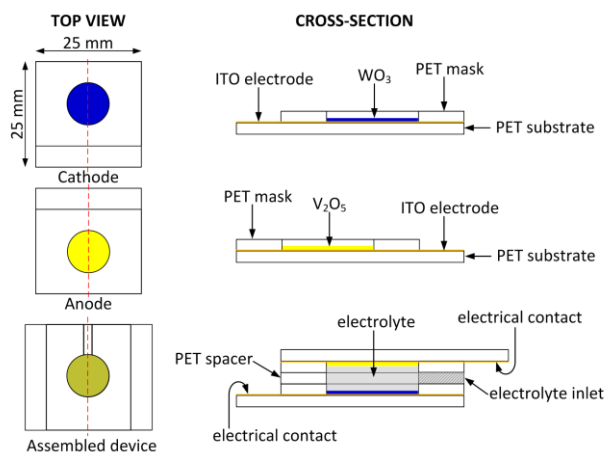

Figure 4. General Assembly of the prepared electrochromic devices.

At this point the electrolyte pre-polymer mixture was introduced between the electrodes by a syringe through the lateral channel of ca. 1 mm diameter cut off in the PET spacer; the electrode area and side channel were completely filled to ensure a certain encapsulation after polymerization. Successively the device was set under UV lamp and the curing was performed for approximately 3 min in nitrogen atmosphere [22] by obtaining a good adhesion and electrical contact between anode and cathode. The acceptable insulation from moisture due to the electrolyte polymerized without RTIL or EC-DEC in the lateral channel limited strongly solvent evaporation during successive tests. After this procedure the ECD was ready to be powered with wiring connected to exposed ITO areas of cathode and anode.

2.4. Characterization techniques

CH Instrument 600D Station (galvanostat/potentiostat, CHI instruments, Austin, USA) was used for electrochemical measurements and to operate the ECD, by registering current vs. potential and current vs. time curves. AC impedance spectroscopy was employed to investigate the ionic conductivity of the polymeric membrane [21]; frequency range was 100 kHz - 1 Hz with a three electrode testing cell made of stainless steel (SS) electrodes having the configuration: SS/PE/SS. Cyclic voltammeteries of the cathodes were registered in 1 M LiClO₄ Propylene Carbonate (PC) with a standard three electrode custom made cell with WO₃ deposited on ITO as working electrode, a Platinum wire as counter electrode and an Ag/AgCl/KCl electrode as reference. Spectro-electrochemical measurements were carried out by placing the ECD in the sample compartment of a Varian Cary 500 UV-VIS spectrophotometer. Two different types of measurement were performed by coupling the spectrophotometer with the CH 600D potentiostat. The first type of experiment was the registration of the ECD complete UV-VIS absorption spectrum as function of applied potential; the second type of experiment consisted in the acquisition of the ECD absorption at a specific wavelength as function of time during potential modulation i. e. repeated bleaching and coloring cycles. The wavelength selected was that showing maximum variation of Percent Transmittance ($\Delta T\%$) in the corresponding full spectrum measurement. The second type of experiment was necessary to measure the ECD switching time of bleaching (ST_B) and the switching time of coloring (ST_C).

Morphological characterization of the samples of V₂O₅ and estimation of the thickness of deposited layer was performed employing a FEI Quanta Inspect 200LV scanning electron microscope (SEM, max magnification of 1.5×10^5) equipped with an Everhardt Thornley secondary electron detector (ET-SED). Prior to analysis, all the samples were coated with a thin Cr layer (around 10 nm thick) to minimize the effect of the electron beam irradiation.

Morphological characterization of the samples of WO₃ and estimation of the thickness of deposited layer was obtained with a Zeiss Auriga SEM-FIB operated with an acceleration voltage of 2kV and aperture size of 30 μ m, using secondary electrons image.

3. RESULTS AND DISCUSSION

The switching time, mechanical features and safety degree of ECD, are strongly affected by the physico-chemical properties of electrolyte employed. In order to develop environment-friendly ECD and to obtain a certain degree of flexibility, the use of customizable polymeric electrolytes is probably the simplest practical approach. In this work we developed an optimized methacrylate-based polymer matrix with Room temperature Ionic Liquid (RTIL) as a gel polymer electrolyte (PE) for electrochromic systems. Similar polymer based electrolytes have already been reported for the application in Li-ion cells [15, 18, 19, 24] and the benefits of such optimized formulation are exploited here in ECD for the first time.

3.1 Polymer membrane

The ionic conductivity of BEMA/PEGMA based membranes prepared with a certain percentage of LiTFSI (10 wt %) dissolved in the EMITFSI liquid (RTIL) was evaluated by impedance spectroscopy and the Arrhenius plot is reported in Figure 5. The Plot shows a ionic conductivity of about $1 \cdot 10^{-4} \text{ S} \cdot \text{cm}^{-1}$ at room temperature. The ionic conductivity increases with the temperature, resulting in a value as high as $2 \cdot 10^{-3} \text{ S} \cdot \text{cm}^{-1}$ at 80°C .

The addition of different amounts of PEGMA as a reactive diluent helped to increase the ionic conductivity as it can control the cross-linking density during the polymerization reaction and, the pendant ethylene oxide groups can help the mobility of Li^+ ions through the matrix.

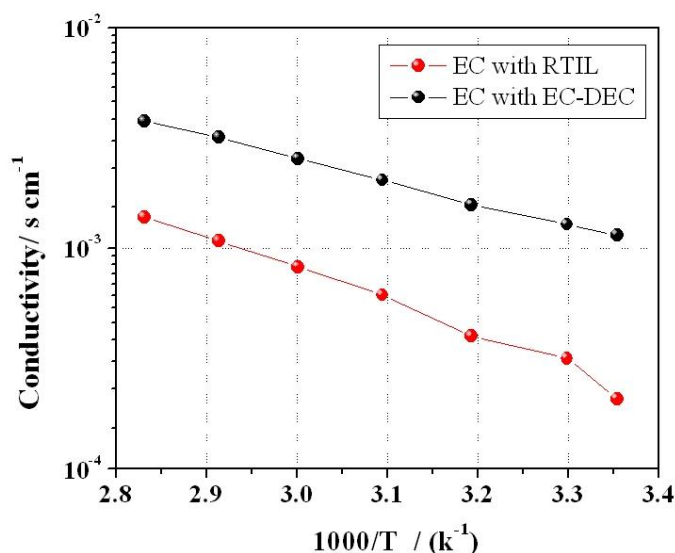

Figure 5. Arrhenius plot showing the Ionic conductivity of polymer electrolyte membrane based on the reactive formulation containing BEMA /PEGMA (composition 20 %/ 10 % w:w) RTIL or EC-DEC (57% w:w) and LiTFSi (10 % w:w) between 25°C and 80°C .

Unfortunately the ionic conductivity of the membrane containing the RTIL is lower than that of the membrane containing only EC-DEC as solvent (in this case the conductivity is in the order of $10^{-4} \text{ S} \cdot \text{cm}^{-1}$ at room temperature [24], see Figure 5). This decrease in the ionic conductivity could be due to the higher viscosity of the RTIL as compared to the EC/DEC mixture. This increase in the viscosity may slow the mobility of the ions. Moreover the dielectric constant of EC/DEC mix is higher than the RTIL and it could directly reflect on the ionic polarization behavior and consequent ion pair formation as well as aggregation. The choice to use the RTIL can be determined by the willingness to increase the safety. In fact, this electrolyte was chosen also considering its extended electrochemical stability [24], no decomposition occurs below 4.5 V vs Li/Li^+ .

3.2 Electrochemical measurements

WO₃/PE/V₂O₅ Electrochromic Devices (ECD)

A typical WO₃/PE/V₂O₅ ECD was tested with the following electrodes configuration: WO₃ Inkjet- printed on ITO as cathode and working electrode; V₂O₅ electro-deposited on ITO as anode, counter and reference electrode. To evaluate the electrochemical behavior of the ECD, a double potential step chronoamperometric experiment was performed (E₁= -2.0 V, E₂= + 2.0 V vs. V₂O₅ electrode t₁=t₂= 10 s E vs. V₂O₅). As comparison the BEMA/PEGMA/LiTFSI polymer electrolyte (PE) was used alternatively with EC/DEC or RTIL as solvent. The typical current vs. time profile of ECD with the different solvents is shown in Figure 6. In agreement with reported mechanisms [1,3,4], the electrochemical insertion of lithium cations into WO₃ occurs in the selected potential range according to the following reaction:

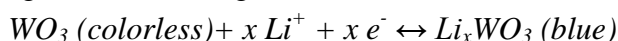

The current vs. time profile suggests, for both cases, a good reproducibility and reversibility of the colouring/bleaching processes during repeated Li⁺ insertion and de-insertion cycles. The reaction occurring at the WO₃ cathode corresponds to the one reported in the previous equation. When the electrochemical reduction of WO₃ occurs at the cathode, the oxidation of V₂O₅ takes place at the anode. Considering that the electrochemical deposition of V₂O₅ carried out in galvanostatic conditions lead to the formation of mixed oxides, a certain percentage of V oxides in lower oxidation state (IV and III) is always present by making the ECD electrochemically switchable by reduction from the first cycle of potential application [25].

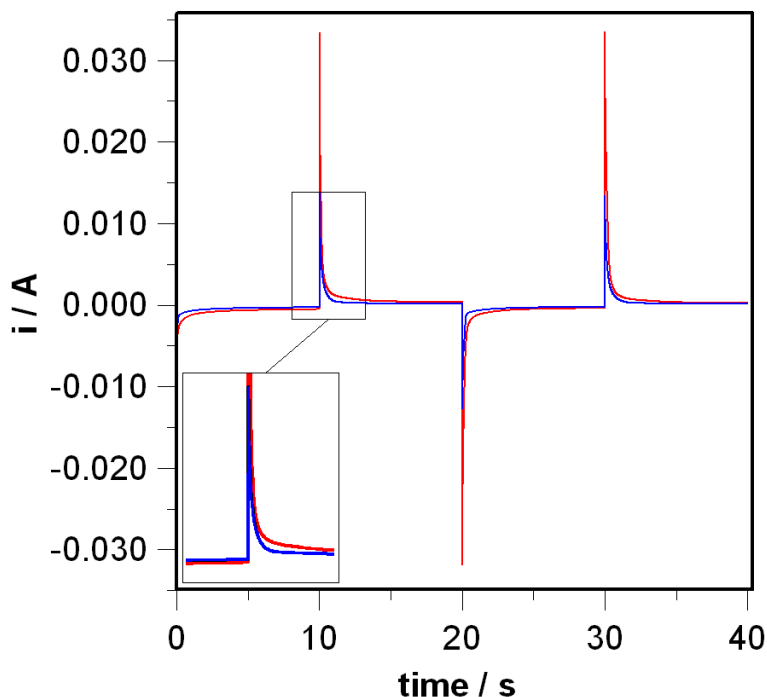

Figure 6. Chronoamperometric profiles of WO₃/PE/V₂O₅ ECD with methacrylate based electrolytes. (blue curve) RTIL as solvent; (red curve) EC-DEC 1:1 as solvent. Potential program: E₁= -2.0 V, E₂= + 2.0 V. t₁=t₂= 10 s. Potentials are vs. V₂O₅ electrode.

From Figure 6 (please note the magnification in the inset) one can note that in general the current values are higher for the device with EC/DEC as solvent. This can be easily understood considering the already discussed lower conductivity of electrolytes containing RTIL.

3.3 Spectro-Electrochemical measurements

To estimate the ECD switching times, steps of positive and negative potential have been sequentially applied to ECD, for several cycles with the following program: $E_1 = +2$ V, $E_2 = -2$ V vs. V_2O_5 ; $t_1 = t_2 = 20$ s. In Figure 7 the Percent Transmittance $T\%(700\text{ nm})$ of ECD is reported as function of time by varying the solvent (RTIL or EC-DEC). By observing Figure 7A one can easily note that in general in the tested ECD the bleaching process, occurring during electrochemical oxidation, appears to be faster than the coloring process. The switching time for Bleaching (ST_B) and the switching time for coloring (ST_C) can be easily calculated from the $T\%$ vs. time curves by the time necessary after bias inversion to reach the 80% of the maximum (bleaching, oxidation) or minimum (coloring, reduction) $T\%$ starting from previous potential step minimum or maximum $T\%$ respectively.

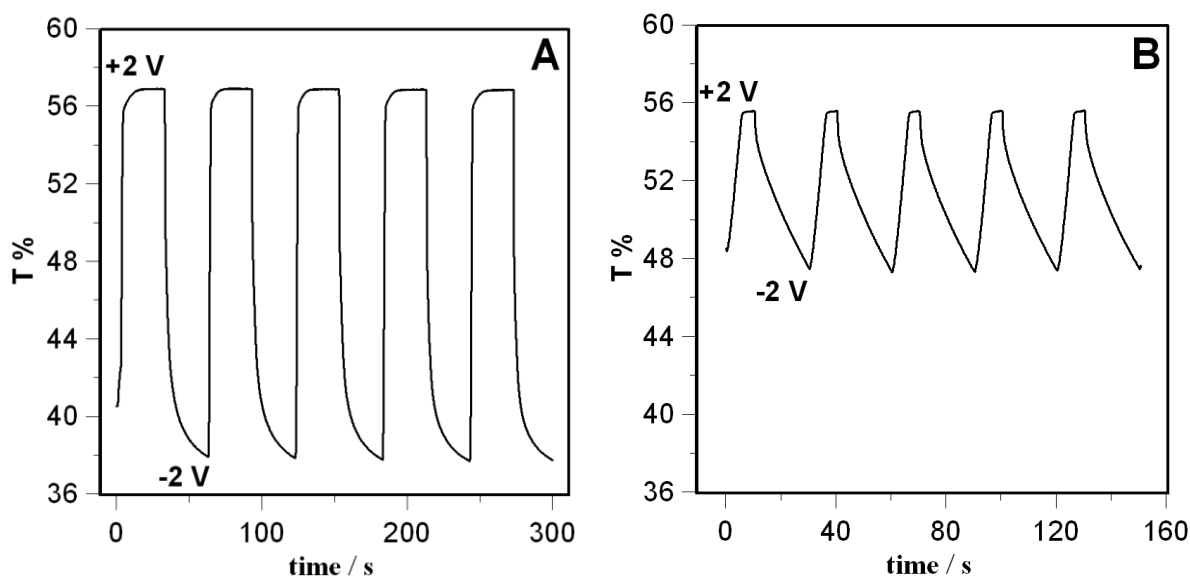

Figure 7. Typical time plot of $T\%(700\text{ nm})$ during repeated switching between bleached and colored state for a $WO_3/PE/V_2O_5$ ECD. (A section) EC-DEC as solvent; (B section) RTIL as solvent. Potential program: $E_1 = +2$ V, $E_2 = -2$ V; $t_1 = t_2 = 20$ s. Potentials are vs. V_2O_5 electrode. Electrodes configuration: WO_3 as Cathode and Working Electrode; V_2O_5 as Anode, Counter and Reference Electrode.

According to this definition we found for our ECD with EC-DEC as solvent $ST_B = 1.9$ s and $ST_C = 4.8$ and in the case of ECD with RTIL as solvent $ST_B = 4.8$ s and $ST_C = 16.7$ s. The slower switching times for the latter ECD are due to the lower conductivity of the PE incorporating RTIL with respect to those with the routine EC-DEC solvent. To monitor the effect of the Li^+ insertion and de-insertion on the UV-VIS light absorption the typical spectrum of an ECD has been registered after

biasing for 1 minute the device at different potentials as reported in Figure 8. The UV-VIS spectrum was recorded at potentials ranging from 0 V to -3V (vs. V_2O_5 electrode). The biasing for a quite long time (a minute) and the large potential variation were necessary to ensure a complete colour change comparing thus the behavior of ECD containing RTIL and those with EC-DEC. It is important to note that the electrochemical stability window for both polymer electrolytes are wide enough to get no electrolyte decomposition or change [19].

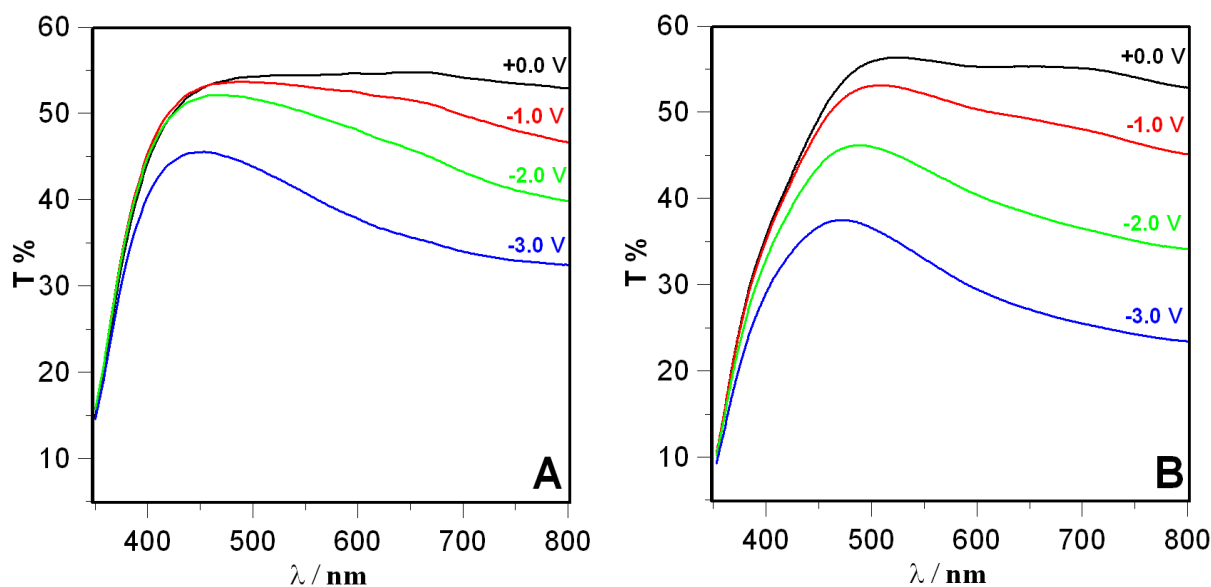

Figure 8. Typical UV-VIS transmittance spectrum of $WO_3/PE/V_2O_5$ ECD at different values of applied potential. Each spectrum was registered after biasing for 60 seconds the ECD at the selected potential ranging from 0 to -3 V vs. V_2O_5 electrode. (A section) EC-DEC as solvent; (B section) RTIL as solvent. Electrodes configuration: WO_3 as Cathode and Working Electrode; V_2O_5 as Anode, Counter and Reference Electrode.

By increasing the negative potential, the ECD becomes progressively more intensely colored ($T\%$ decrease), as it is clearly evident from $\Delta T\%$ in 500-800 nm region. The change in colour was already detectable by naked eye at -1V; with a bias of -2 V the colour change was almost complete with EC-DEC and RTIL solvent. To evaluate the performance of the device, $\Delta T\%$ has been calculated and compared for the two different solvents (Table 1). In the studied ECD, a considerable change in color has been detected extensively during potential switching in VIS-NIR spectral region; the maximum $\Delta T\%$ has been detected for wavelengths ≥ 700 nm. In principle after one minute of biasing by changing only the solvent from EC-DEC to RTIL the devices should show the same change in color (i. e. $\Delta T\%$). Our experimental findings suggest however that apparently the amount of intercalated Li^+ is different even if the PE thickness and Li^+ molar concentration is the same in compared devices. Figure 8 shows clearly that the amount of charge inserted in the film is different, because $\Delta T\%$ varies. Considering that the effective change in color, as measured by $\Delta T\%$, depends on the number of WO_3 centers effectively oxidised or reduced we can suppose that RTIL solvent has an higher permeability in the WO_3 layer with respect to EC-DEC accessing more redox centers in the same cathode area.

Another possible explanation to the increase of device contrast could be the increase of elasticity (i.e. variation of Young's modulus) of the PE containing RTIL with respect to EC-DEC allowing to enhance the electrode-electrolyte adhesion by increasing the effective amount of electrochemically active WO_3 sites.

Table 1. Comparison of $\Delta T\%$ for $\text{WO}_3/\text{PE}/\text{V}_2\text{O}_5$ ECD containing alternatively RTIL or EC-DEC as solvent. A voltage of 0 V ($T_{\max\%}(700 \text{ nm})$) and -3 V ($T_{\min\%}(700 \text{ nm})$) vs. V_2O_5 electrode were respectively applied for 60 seconds.

Solvent	$T_{\max\%}(700 \text{ nm})$	$T_{\min\%}(700 \text{ nm})$	$\Delta T\%$
EC-DEC	54	34	20
RTIL	57	23	33

4. CONCLUSION

A series of ECD with WO_3 inkjet-printed on ITO as cathode, V_2O_5 electrodeposited on ITO as anode, and a BEMA/PEGMA polymer electrolyte containing a Room Temperature Ionic Liquid have been successfully realized and characterized. The behavior of ECD containing RTIL has been compared with that of similar ones containing the routine EC-DEC solvent. Due to the lower ionic conductivity and the apparent higher solvent permeability within WO_3 active layer in the cathode, ECD containing RTIL showed slower switching times, but higher contrast ($\Delta T\%$) with respect to similar devices with EC-DEC as solvent. Considering the overall results obtained here and their high environmental safety RTIL appears to be a promising candidate as solvent and additive to improve the overall performances of electrochromic devices.

ACKNOWLEDGEMENT

EU community is gratefully acknowledged for funding SMART-EC (Heterogeneous integration of autonomous smart films based on electrochromic transistors) Grant Agreement number: 258203 and E. Fortunato's ERC 2008 Advanced Grant (INVISIBLE contract number 228144). This work was also funded by the Portuguese Science Foundation (FCT-MCTES) through project Electra, PTDC/CTM/099124/2008, PEst-C/CTM/LA0025/2013-14, EXCL/CTM-NAN/0201/2012 and PTDC/CTM/103465/2008.

References

1. C. G. Granqvist, *Handbook of Inorganic Electrochromic Materials*, Elsevier, Amsterdam, (2002).
2. Y. Suda, H. Kawasaki, T. Ohshima and Y. Yagyuu, *Thin Solid Film*, 51 (2008) 4397.
3. S.K. Deb, *Sol. Energy Mater. Sol. Cells* 92 (2008) 245.
4. M. Deepa, M. Jikar, D.P. Singh, A. K. Sristava, A. Shahzada, *Sol. Energy Mater. Sol. Cells* 92 (2008) 170.
5. P. J. Wojcik, A. S. Cruz, L. Santos, L. Pereira, R. Martins, E. Fortunato, *J. Mater. Chem.* 22 (2012) 13268.
6. S. Beke *Thin Solid Films*, 519 (2011) 1761.

7. A. Kumar, P. Singh, N. Kulkarni and D. Kaur, *Thin Solid Films*, 516 (2008) 912.
8. S. H. Lee, P. Liu, C. E. Tracy, J. A. Turner, J. R. Pitts and S. K. Deb, *Solid State Ionics* 165 (2003) 223.
9. S. Bodoardo, C. Gerbaldi, G. Meligrana, A. Tuel, S. Enzo and N. Penazzi, *Ionics* 15(1) (2009) 19.
10. M. Pavese, P. Fino, C. Badini, A. Ortona and G. Marino, *Surf. Coat. Technol.* 202(10) (2008) 2059.
11. S. Biamino, A. Antonini, M. Pavese, P. Fino and C. Badini, *Intermetallics*, 16/6 (2008) 758.
12. J. Reiter, O. Krejza and M. Sedlarikova, *Solar En. Solar Cells* 93 (2009) 249.
13. (a) M. Lombardi, P. Fino, G. Malucelli, L. Montanaro, *Composite Structures*, 94 (3) (2012) 1067; (b) P. Fino, M. Lombardi, A. Antonini, G. Malucelli, L. Montanaro, *Composite Structures* 94 (3) (2012) 1060.
14. (a) H.-J. Ha, Y. H. Kwon, J. Y. Kim and S.-Y. Lee, *Electrochim. Acta* 57 (2011) 40; (b) H.-J. Ha, E.-H. Kil, Y. H. Kwon, J. Y. Kim, C. K. Lee and S.-Y. Lee, *Energy Environ. Sci.* 5 (2012) 6491; (c) M.-H. Ryou, D. J. Lee, J.-N. Lee, H. K. Lee, M. Seo, H. Lee, W. H. Shin, Y. M. Lee, J. W. Choi and J.-K. Park, *J. Electrochem. Sci. Technol.* 2 (2011) 198.
15. C. Gerbaldi, J. R. Nair, S. Ahmad, G. Meligrana, R. Bongiovanni, S. Bodoardo and N. Penazzi, *J. Power Sources* 195 (2010) 1706.
16. C. Gerbaldi, *Ionics* 16 (2010) 777.
17. P. C. Barbosa, M. M. Silva, M. J. Smith, A. Goncalves and E. Fortunato, *Thin Solid Films* 516 (2008) 1480.
18. J. R. Nair, C. Gerbaldi, R. Bongiovanni, S. Bodoardo, N. Penazzi, P. Reale and V. Gentili, *J. Power Sources* 178 (2008) 751.
19. J. R. Nair, G. Meligrana, S. Bodoardo, R. Bongiovanni and N. Penazzi, *N. EUPOC2008 conference Gargnano Italy 15-6-08*.
20. E. Zelazowska and E. J. Rysiakiewicz-Pasek, *J. Non-Cryst. Solids* 354 (2008) 4500.
21. C. Pozo-Gonzalo, D. Mecerreyes, J. A. Pomposo, M. Salsamendi, R. Marcilla, H. Grande, R. Vergas, D. Barrios and J. M. Sanchez-Pena, *Sol. Energy Mater. Sol. Cells* 92 (2008) 101.
22. J. R. Nair, C. Gerbaldi, M. Destro, R. Bongiovanni and N. Penazzi, *React. Funct. Polym.* 71 (2011) 409.
23. S. Desai, R. L. Shepherd, C. Innis, P. Murphy, C. Hall, R. Fabretto and G. G. Wallace, *Electrochim. Acta* 56 (2011) 4408.
24. C. Gerbaldi, J. R. Nair, G. Meligrana, R. Bongiovanni, S. Bodoardo and N. Penazzi, *J. Appl. Electrochem.* 39 (2009) 2199.
25. N. Garino, S. Zonarini, S. Bodoardo, J. R. Nair, S. Pereira, L. Pereira, R. Martins, E. Fortunato and N. Penazzi, *Int. J. Electrochem.* ID 138753 (2013).