

Investigation of under-platform damper kinematics and its interaction with contact parameters (nominal friction coefficient)

Muzio M Gola^{1)*}, Tong Liu¹⁾ and Marcelo Braga dos Santos²⁾

¹⁾ Department of Mechanical and Aerospace Engineering, Politecnico di Torino,
Corso Duca degli Abruzzi 24, 10129 Torino, Italy

²⁾ Fac. Eng. Mecânica, Federal University of Uberlândia
Uberlândia, Brazil

*Corresponding author: muzio.gola@polito.it

1.Introduction

Experiments with single contact point or line in vibration show that the friction coefficient is dependent on normal force, surface condition and relative velocity (due to rolling and sliding). The case of the under-platform damper, typically used in turbine blades, is even more complex, its motion depends on normal and tangential forces which are extremely variable and inter-dependent.

Numerical models of damper-platform mechanics frequently assume a tentative constant value of the friction coefficient, and fine tune it against a measured response of a blade vibration.

The novel approach proposed by the authors consists in directly measuring the forces transmitted between the two platforms through the damper, versus the relative motion of the platforms.

In [1] we presented the design and calibration of a test rig where such measurements can be accomplished. In that paper some demonstration results were presented in order to show the capacity of the test rig. In this paper we add 1) a full reconstruction of translational and rotational damper motion, 2) comparisons with the results from a numerical model. The combination of the two allows to understand the contact conditions even in quite complex situations, and to explore the reasons for remarkable changes of the measured hysteresis cycles in operation.

The damper used here is a ‘three point’ damper, shown in Fig.1, a-b. It has a statically determinate configuration, moreover its single line contact acts on the ‘fixed’ platform, which is supported by the force sensors. This allows to fully determine forces, as the point of application in the force sensor plane is known.

Experiments are performed under so called out-of-phase (OoP) and in-phase (IP) condition simulating two important motion types in the platform-damper mechanics, which are shown in Fig.2. Experiments show that the friction coefficient can be very sensitive to the kinematics of the damper and can evolve in different ways in different tests under the same nominal parameters, especially for OoP condition. The combination of rolling and translation of the damper cause a complex influence on the friction coefficient at the three contact lines and vice versa; i.e., the damper kinematics and friction coefficient interact. For the long-run tests of this damper under OoP condition, there is a tendency of increasing the friction

coefficient on both sides, which leads to micro-slip.

The combination of rolling and translation of the damper contact is simulated by applying one macro-slip contact element at each contact point with normal and tangential stiffness through a numerical algorithm based on Newmark- β method. The relation between normal and tangential contact stiffness is taken, according to [2] which credits [3], at 1.5 and the tangential stiffness is here found from experimental data (the slope of a certain part of hysteresis cycle). The simulation is here performed by setting one friction coefficient value for each contact line, however constant throughout the whole cycle. Results show that these values change according to the stage of the experiment.

The friction coefficients at contact in the experiments can vary within the range 0.1-0.8, which is crucial for practical use. The numerical results show that the friction coefficient can be fine tuned so to meet good agreement with the experimental results for both force transfer and kinematics. This macro-slip model limitation is, however, in that it does not simulate the micro-slip regime and rolling resistance.

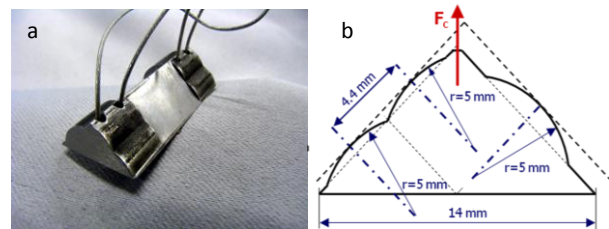

Figure 1 View of the three-point damper

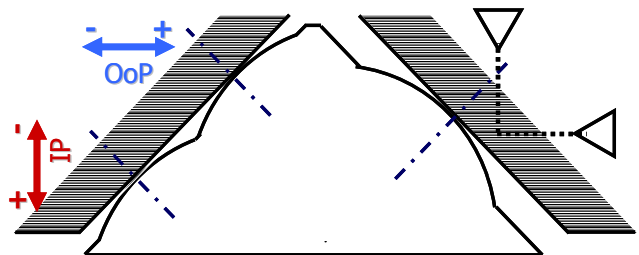

Figure 2 Damper-Platform system

2.Hysteresis features

Under certain relative motion between two adjacent platforms, the hysteresis between transmitted force and respective relative motion, produced by the damper,

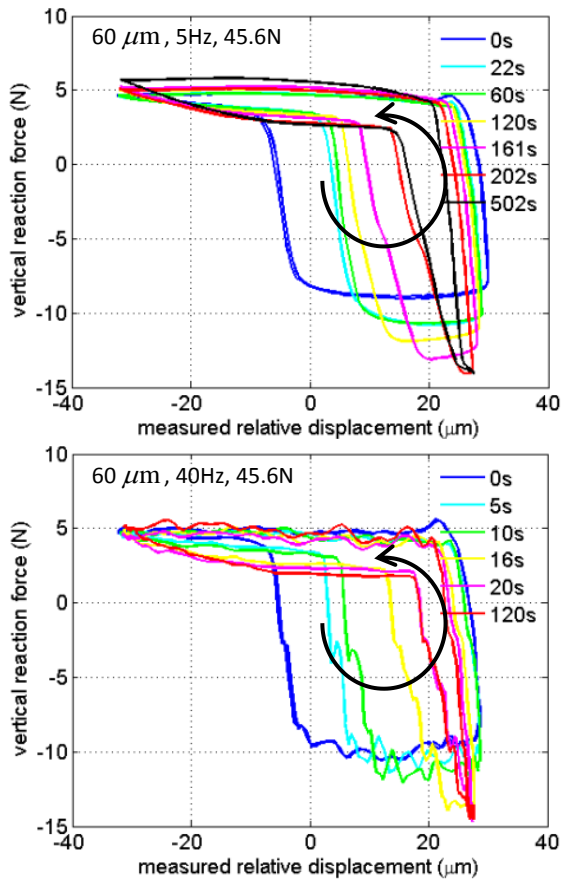

Figure 3 Hysteresis under IP condition

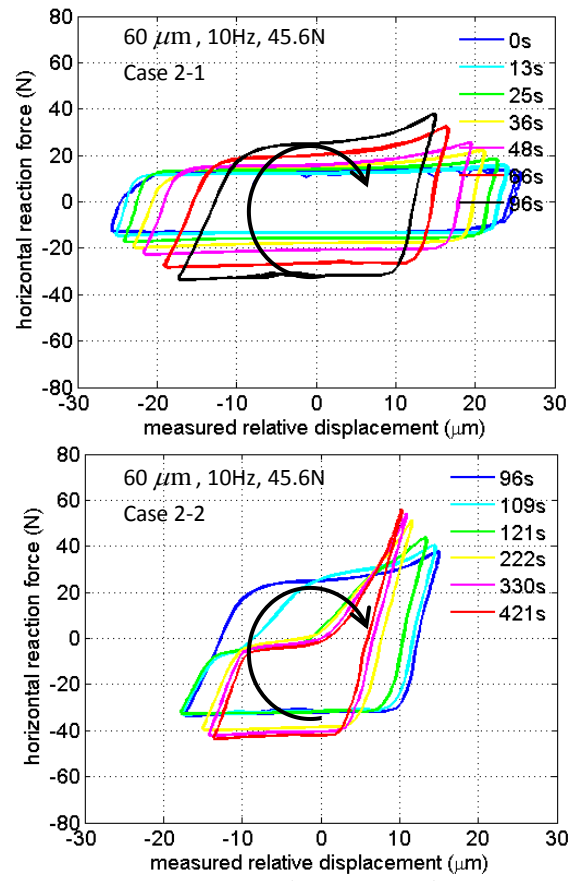

Figure 5 Hysteresis under OoP condition-Case 2

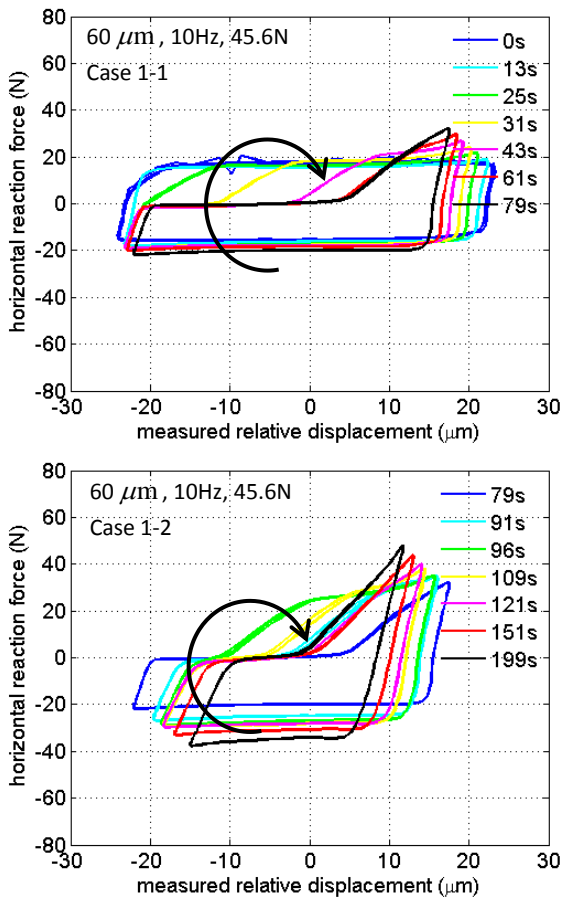

Figure 4 Hysteresis under OoP condition-Case 1

provides the coupled contact information and energy dissipation on dual interfaces.

The typical hystereses under IP and OoP condition are shown in Figure 3,4 and 5. The outer parameters listed inside each diagram are: nominal amplitude between two platforms, excitation frequency, simulated centrifugal force (here a deadweight of 4.65 kg is applied).

For both conditions, the hysteresis evolves with time, possibly due to contact parameter variation. It also poses a fact that the system is sensitive to certain contact parameters and there exist stable or instable regions for the system dynamics, especially for OoP condition where the hysteresis can evolve differently under the same outer parameters. The difference between IP and OoP is that for IP condition the transmitted force excursion is not increased so much as in the OoP condition. The larger rotation under IP condition may dominate and keep the friction coefficients relatively low and the smaller rotation under OoP condition is not sufficient to keep the friction coefficients low and favours micro-slip with high contact force. It is found, although there is no space for the proof here, that the inverted Γ shape of IP hysteresis and the shoe shape of OoP hysteresis cycles are linked with the corresponding rotations, which are observed through measurements as those described in section 3.

3. Damper motion and force transmission features

Fig. 6 and 7 demonstrate an example of experimental and simulated force transmission through the damper. Fig.8 shows the modeling of the system, where at each contact interface one 2D macro slider with

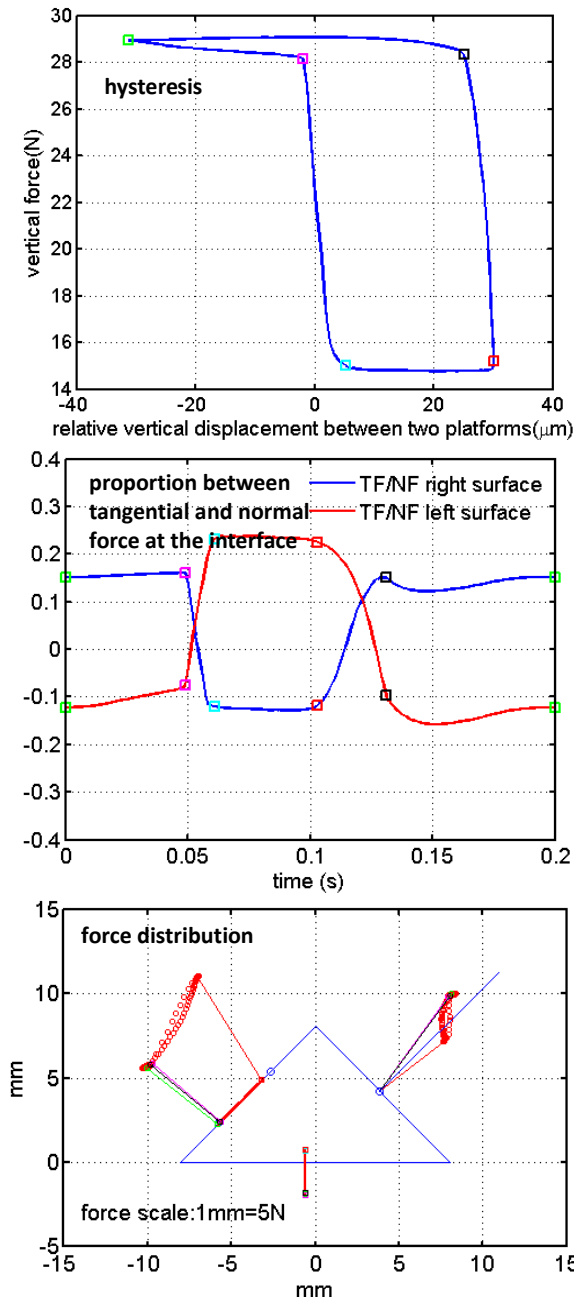

Figure 6 Experiment example of hysteresis and related force transmission

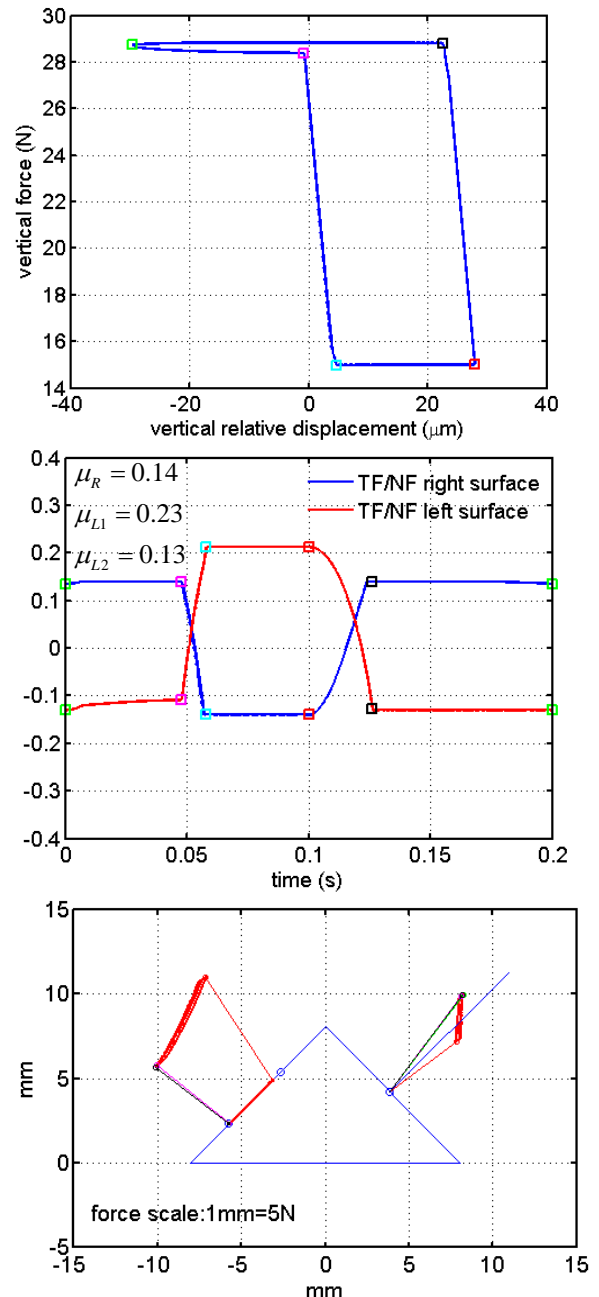

Figure 7 Simulation example of hysteresis and related force transmission

normal and tangential stiffness is applied. The real transmitted forces in the experiments are obtained from load removal, which overcomes the shortcoming of piezo force sensors [1]. The friction coefficient values used in the simulation are taken as the highest value of the ratio between tangential and normal force at the interface found in experiments.

Different stages of the cycle are identified through points in colour, and can be analysed separately. The simulations are reasonably consistent with the experiments. Both show that the upper contact point on the left surface loses contact during the cycle while the force goes with remarkable accuracy (within 0.5 mm) on the lower point.

Also the reconstruction of damper motion from experiments is very satisfactory.

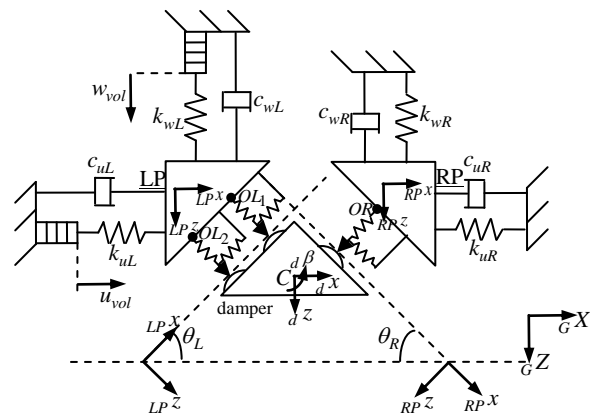

Figure 8 Modeling of the system and contact element

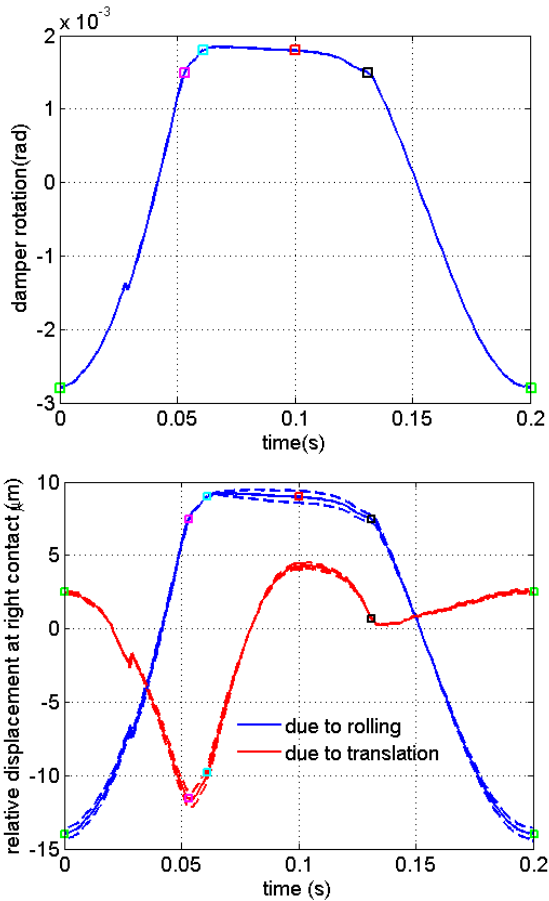

Figure 9 Measurement of damper motion

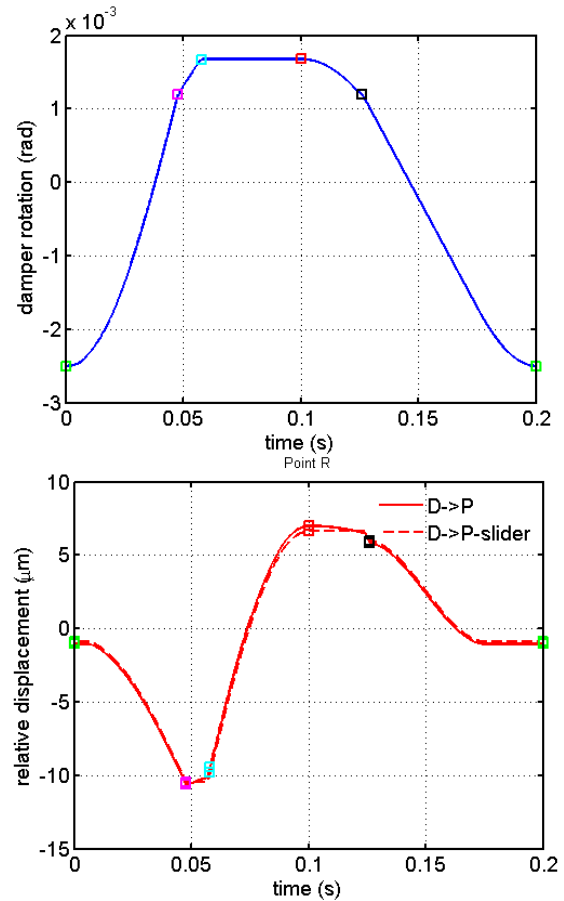

Figure 10 Simulation of damper motion

The damper is assumed to be a rigid body except for the contact elasticity, and always in contact with the right-platform. Thus by measuring damper rotation and vertical motion of the damper bottom relative to the right platform, the complete movement of the damper is reconstructed. From this, contact sliding and rolling components can be determined.

Fig.9 shows measured damper rotation and reconstructed relative motion at the right interface for the case elaborated in Fig.7. Fig.10 gives the corresponding simulated results.

For example, in Fig.9 from marked green-to-pink points, rotation angle is large and at the right contact interface mixed counterclockwise rolling and relative translation up (damper to platform) takes place.

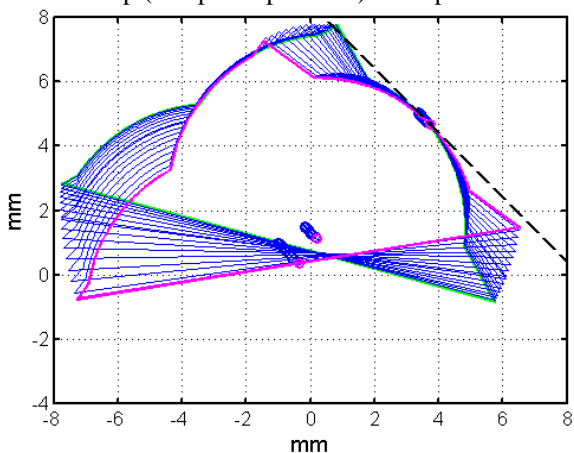

Figure 11 Example of damper movement reconstruction

Fig.11 shows the experimental damper movement in this stage. Visually the contact position does not change a lot because sliding up happens simultaneously with counterclockwise rolling.

4. Conclusions

In this extended abstract a laboratory under-platform damper is tested within the experimental damper-platform system to investigate its response features. It is stressed that the test rig allows to obtain quite accurate force and kinematic measurements. Also, simulations and experimental results are in good agreement both for force transmission and for kinematics.

It is observed that the response is sensitive to friction coefficients at contact interfaces. The agreement is achieved by fine tuning the friction coefficients by estimations from experimental outcome.

References

- [1] Muzio M.Gola, Marcelo Braga d.Santos, Liu Tong, "Measurement of the scatter of underplatform damper hysteresis cycle: experimental approach", ASME IDETC 2012, August 12-15, 2012, Chicago
- [2] Csaba G., "Modelling of a Microslip Friction Damper Subjected to Translation and Rotation," ASME International Gas Turbine Conference, June 7-10, Indianapolis, IN.
- [3] Johnson K.L., 1985, "Contact Mechanics", Cambridge University Press PIN:5