



Quadrature-  
based  
moment  
methods

D. L.  
Marchisio

GPBE

Velocity  
disperse  
phase

Solution  
methods

Examples

Moment  
corruption

Spatial  
discretization  
in DQMOM

Conclusions

# Quadrature-based moment methods for the simulation of turbulent polydisperse multiphase systems

**D. L. Marchisio**

Dipartimento di Scienza Applicata e Tecnologia, Istituto di Ingegneria  
Chimica, Politecnico di Torino

9th European Congress of Chemical Engineering, World  
Forum, The Hague, The Netherlands, April 21-25, 2013



# Introduction

Quadrature-  
based  
moment  
methods

D. L.  
Marchisio

GPBE

Velocity  
disperse  
phase

Solution  
methods

Examples

Moment  
corruption

Spatial  
discretization  
in DQMOM

Conclusions

- This presentation concerns the simulation of multiphase **polydisperse** systems with Eulerian methods
- Disperse means that there is a continuous phase and one (or more) additional phases constituted by separate elements: particles, droplets or bubbles
- The elements of the disperse phase are characterized by some properties, often referred to as **internal coordinates**, such as particle size, volume, momentum, mass, enthalpy
- The system is polydisperse because each particle is characterized by a different value of these properties, resulting in **distributions**
- Particle size distribution (PSD), bubble size distribution (BSD), crystal size distribution (CSD), particle velocity distribution (PVD)



# Introduction

Quadrature-based moment methods

D. L. Marchisio

GPBE

Velocity disperse phase

Solution methods

Examples

Moment corruption

Spatial discretization in DQMOM

Conclusions

## Historically two approaches have been used:

- Focusing on the PSD and neglecting spatial inhomogeneities; **population balance equation**:

$$\frac{\partial n(L)}{\partial t} + \frac{\partial}{\partial L} (G(L)n(L)) = S(L)$$

- Focusing on spatial inhomogeneities and neglecting the PSD; **two-fluid model** (all particles have size  $L = d_p$ ):

$$\frac{\partial \alpha_p}{\partial t} + \frac{\partial}{\partial \mathbf{x}} \cdot (\alpha_p \mathbf{U}_p) = 0$$

$$\begin{aligned} \frac{\partial \alpha_p \mathbf{U}_p}{\partial t} + \frac{\partial}{\partial \mathbf{x}} \cdot (\alpha_p \mathbf{U}_p \mathbf{U}_p) &= -\frac{\alpha_p}{\rho_p} \frac{\partial p_f}{\partial \mathbf{x}} + \alpha_p \mathbf{g} \\ &+ \frac{3}{4} \frac{\rho_f}{\rho_p} \frac{C_D(d_p)}{d_p} |\mathbf{U}_f - \mathbf{U}_p| (\mathbf{U}_f - \mathbf{U}_p) \end{aligned}$$



# Introduction

Quadrature-  
based  
moment  
methods

D. L.  
Marchisio

GPBE

Velocity  
disperse  
phase

Solution  
methods

Examples

Moment  
corruption

Spatial  
discretization  
in DQMOM

Conclusions

- The PSD is related to  $\alpha_p$  through the **moment transform**:

$$\alpha_p = k_V \int_0^\infty n(L) L^3 dL = k_V m_3$$

- In general, the moment transform of order  $k$ :  
 $m_k = \int_0^\infty n(L) L^k dL$  can be used to define global properties from the PSD
- **Microscale model**: defined at the particle level
- **Mesoscale model**: defined at the population level
- **Macroscale model**: defined on the global properties of the population
- The PBE is a mesoscale model (defined through an **ensemble-average** from the microscale model), whereas the two-fluid model is a macroscale model (usually derived through **volume-average** directly from the microscale model)



# Introduction

Quadrature-based moment methods

D. L. Marchisio

GPBE

Velocity disperse phase

Solution methods

Examples

Moment corruption

Spatial discretization in DQMOM

Conclusions

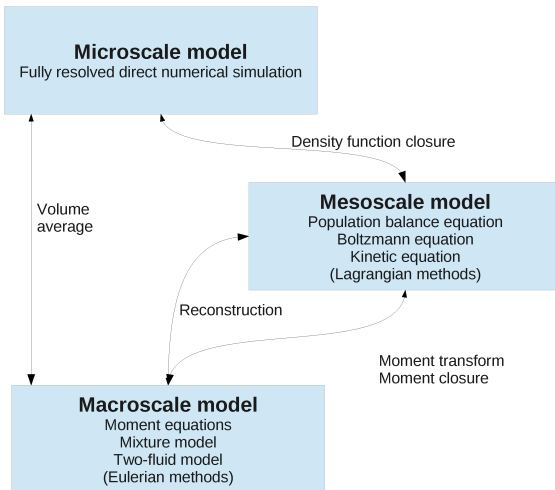



# Outline

Quadrature-  
based  
moment  
methods

D. L.  
Marchisio

GPBE

Velocity  
disperse  
phase

Solution  
methods

Examples

Moment  
corruption

Spatial  
discretization  
in DQMOM

Conclusions

- 1 GPBE
- 2 Velocity disperse phase
- 3 Solution methods
- 4 Examples
- 5 Moment corruption
- 6 Spatial discretization in DQMOM
- 7 Conclusions



Quadrature-  
based  
moment  
methods

D. L.  
Marchisio

GPBE

Velocity  
disperse  
phase

Solution  
methods

Examples

Moment  
corruption

Spatial  
discretization  
in DQMOM

Conclusions

# GENERALIZED POPULATION BALANCE EQUATION



# Generalized Population Balance Equation

Quadrature-  
based  
moment  
methods

D. L.  
Marchisio

GPBE

Velocity  
disperse  
phase

Solution  
methods

Examples

Moment  
corruption

Spatial  
discretization  
in DQMOM

Conclusions

- Independent variables are classified as **external** (space) and **internal** (velocity, size, composition) coordinates
- In general other internal coordinates can be used and here particle velocity, size and composition are just an example
- First we define a Number Density Function (NDF) so that:

$$n^*(t, \mathbf{x}, \mathbf{v}_p, L, \phi_p) d\mathbf{x} d\mathbf{v}_p dL d\phi_p$$

represents the expected number of particles, droplets or bubbles, in the infinitesimal volume  $d\mathbf{x} = dx_1 dx_2 dx_3$  around the physical point  $\mathbf{x} = (x_1, x_2, x_3)$  with velocity in between  $\mathbf{v}_p$  and  $\mathbf{v}_p + d\mathbf{v}_p$ , size  $L$  and  $L + dL$ , and composition (number of moles of a specific component)  $\phi_p$  and  $\phi_p + d\phi_p$





# Generalized Population Balance Equation

Quadrature-based moment methods

D. L. Marchisio

GPBE

Velocity disperse phase

Solution methods

Examples

Moment corruption

Spatial discretization in DQMOM

Conclusions

- The evolution of the NDF is dictated by the Generalized Population Balance Equation (GPBE):

$$\begin{aligned} \frac{\partial n^*}{\partial t} + \frac{\partial}{\partial \mathbf{x}} \cdot (\mathbf{v}_p n^*) + \frac{\partial}{\partial L} (\langle G \rangle n^*) \\ + \frac{\partial}{\partial \mathbf{v}_p} \cdot (\langle \mathbf{A}_p \rangle n^*) + \frac{\partial}{\partial \phi_p} \cdot (\langle \dot{\phi}_p \rangle n^*) = h(t, \mathbf{x}, L, \mathbf{v}_p, \phi_p) \end{aligned}$$

- $\langle G \rangle$  is the continuous growth rate,  $\langle \mathbf{A}_p \rangle$  is force per unit mass (i.e., continuous acceleration) acting on the particles,  $\langle \dot{\phi}_p \rangle$  is the continuous rate of change of composition and  $h$  is the discontinuous term accounting for the instantaneous changes in size, composition and momentum due to discrete events (such as collision, aggregation, breakage)
- $\langle G \rangle$ ,  $\langle \mathbf{A}_p \rangle$ ,  $\langle \dot{\phi}_p \rangle$ , and  $h$  are conditional phase-space velocities or **mesoscale models** for the population of particles



# Generalized Population Balance Equation

Quadrature-based moment methods

D. L. Marchisio

GPBE

Velocity disperse phase

Solution methods

Examples

Moment corruption

Spatial discretization in DQMOM

Conclusions

## Example: drag force for bubbly flow

- Acceleration acting on one single spherical bubble:

$$\mathbf{A}_p = -\frac{1}{\rho_p} \frac{\partial p_f}{\partial \mathbf{x}} + \frac{3}{4} \frac{C_D}{L} \frac{A_D}{V_p} \frac{\rho_f}{\rho_p} |\mathbf{U}_f - \mathbf{U}_p| (\mathbf{U}_f - \mathbf{U}_p)$$

where for a contaminated system :

$$C_D = \max \left[ \frac{24}{\text{Re}_p} (1 + 0.15 \text{Re}_p^{0.687}), \frac{8}{3} \left( \frac{\text{Eo}}{\text{Eo} + 4} \right) \right]$$

- To calculate  $\langle \mathbf{A}_p \rangle$  one needs to account for bubble interaction and microscale turbulence ( $\text{Re}_{\text{eff}} = L \rho_f |\mathbf{U}_f - \mathbf{U}_p| / \mu_{\text{eff}}$ ):

$$C_D = (1 - \alpha_p) C_1 \max \left[ \frac{24}{\text{Re}_{\text{eff}}} (1 + 0.15 \text{Re}_{\text{eff}}^{0.687}), \frac{8}{3} \frac{\text{Eo}}{\text{Eo} + 4} \right]$$



Quadrature-  
based  
moment  
methods

D. L.  
Marchisio

GPBE

Velocity  
disperse  
phase

Solution  
methods

Examples

Moment  
corruption

Spatial  
discretization  
in DQMOM

Conclusions

# VELOCITY OF THE DISPERSE PHASE



# The problem of the velocity of the dispersed phase<sup>1</sup>

Quadrature-based moment methods

D. L. Marchisio

GPBE

Velocity disperse phase

Solution methods

Examples

Moment corruption

Spatial discretization in DQMOM

Conclusions

- Particle velocity is an important internal coordinate since it is related to particle position (external coordinate) through Newton's law!
- It can be **included in the set of internal coordinates**, resulting in mixed particle velocity moments<sup>1</sup>
- It can be **integrated out** from the GPBE:

$$n(t, \mathbf{x}, L, \phi_p) = \iiint_{-\infty}^{+\infty} n^*(t, \mathbf{x}, \mathbf{v}_p, L, \phi_p) d\mathbf{v}_p$$

resulting in the following equation:

$$\frac{\partial n}{\partial t} + \frac{\partial}{\partial \mathbf{x}} (\langle \mathbf{U}_p | L, \phi_p \rangle n) + \frac{\partial}{\partial L} (\langle G \rangle n) + \frac{\partial}{\partial \phi_p} (\langle \dot{\phi}_b \rangle n) = h$$

- The conditional particle velocity has to be calculated from equations derived from the GPBE with the moment transform!

<sup>1</sup>Vikas, Yuan, Wang, and Fox, 2011. Modeling of bubble-column flows with quadrature-based moment methods, Chem. Eng. Sci., 66, 3058-3070



# The problem of the velocity of the dispersed phase

There are three key parameters: particle loading,  $\rho_p/\rho_f$ , particle Stokes number,  $St$ , and polydispersity, PDI

- 1 Diffusion equation:** sub-micron particles / Brownian motion
- 2 Pseudo-homogeneous or dusty-gas model:** very small  $St$  and limited PDI
- 3 Algebraic Eulerian model with a single conditional velocity based on the mean particle size:** small  $St$  and limited PDI
- 4 Algebraic Eulerian model with conditional velocities:** small  $St$  and non-negligible PDI
- 5 Eulerian two-fluid model with particle-phase velocity based on the mean particle size:** moderate/large  $St$  and limited PDI (in both dilute and dense systems)
- 6 Eulerian multi-fluid model:** moderate/large  $St$  and large PDI (in both dilute and dense systems)

Quadrature-based moment methods

D. L. Marchisio

GPBE

Velocity disperse phase

Solution methods

Examples

Moment corruption

Spatial discretization in DQMOM

Conclusions



Quadrature-  
based  
moment  
methods

D. L.  
Marchisio

GPBE

Velocity  
disperse  
phase

**Solution  
methods**

Examples

Moment  
corruption

Spatial  
discretization  
in DQMOM

Conclusions

# SOLUTION METHODS



# Solution methods based on quadrature closure

Quadrature-  
based  
moment  
methods

D. L.  
Marchisio

GPBE

Velocity  
disperse  
phase

Solution  
methods

Examples

Moment  
corruption

Spatial  
discretization  
in DQMOM

Conclusions

- The mesoscale model is highly dimensional (1 time + 3 spatial coordinates + 1 size + 3 velocities + ...)
- One interesting way to solve it is to resort to **Lagrangian / Direct Simulation Monte Carlo (DSMC)**
- Equations for moments of the NDF (Eulerian / macroscale model): **Quadrature Method of Moments (QMOM)**
- Inversion algorithms for univariate problems (only size): Product-Difference or Wheeler algorithms
- Inversion algorithms for multivariate problems (size and composition): Brute force methods, tensor-product methods, **Conditional QMOM (CQMOM)**
- The quadrature approximation can also be tracked directly by preserving an optimal moment set: **Direct Quadrature Method of Moments (DQMOM)**



# Comparison DSMC with CQMOM/DQMOM

Quadrature-based moment methods

D. L. Marchisio

GPBE

Velocity disperse phase

Solution methods

Examples

Moment corruption

Spatial discretization in DQMOM

Conclusions

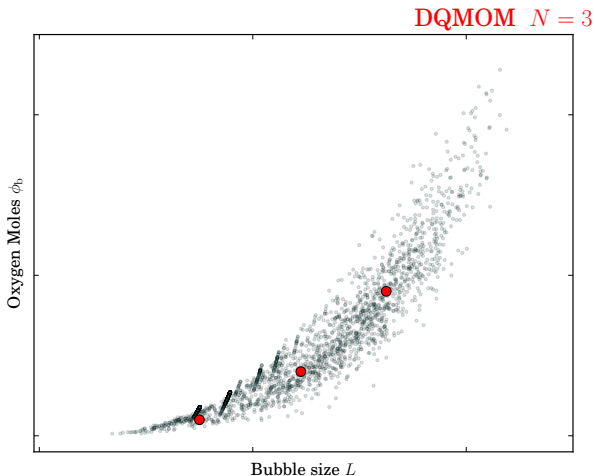





# Comparison DSMC with CQMOM/DQMOM

Quadrature-based moment methods

D. L. Marchisio

GPBE

Velocity disperse phase

Solution methods

Examples

Moment corruption

Spatial discretization in DQMOM

Conclusions

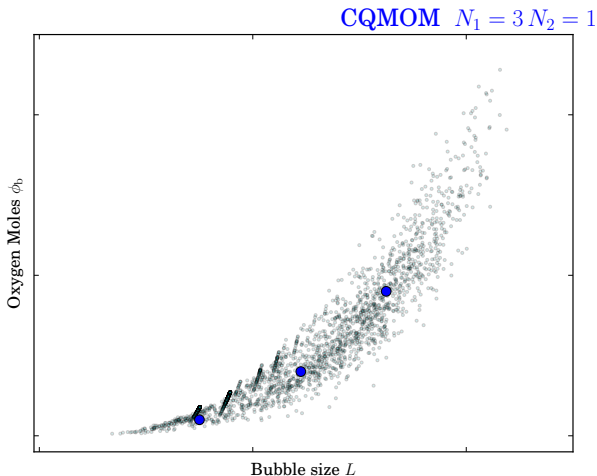



# Comparison DSMC with CQMOM/DQMOM

Quadrature-based  
moment  
methods

D. L.  
Marchisio

GPBE

Velocity  
disperse  
phase

Solution  
methods

Examples

Moment  
corruption

Spatial  
discretization  
in DQMOM

Conclusions

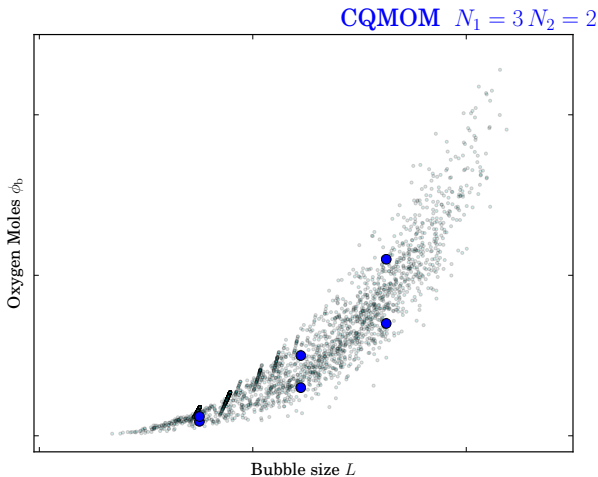



# Comparison DSMC with CQMOM/DQMOM

Quadrature-based  
moment  
methods

D. L.  
Marchisio

GPBE

Velocity  
disperse  
phase

Solution  
methods

Examples

Moment  
corruption

Spatial  
discretization  
in DQMOM

Conclusions

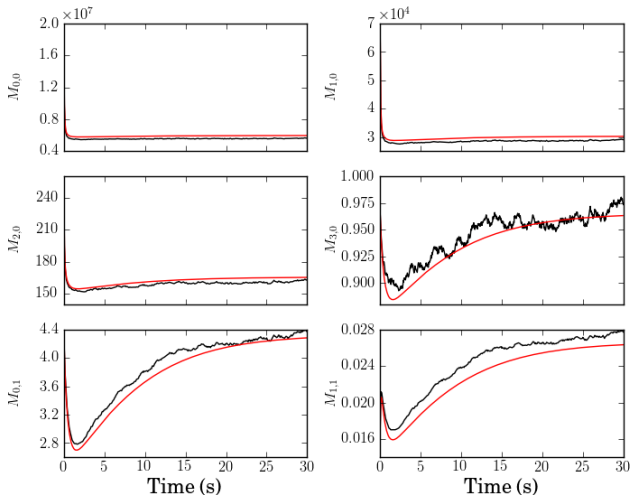

Coalescence, breakage and mass transfer. Solid black line: DSMC method. Red line CQMOM with  $N_1 = 3$  and  $N_2 = 1$  and DQMOM with  $N = 3$ .



Quadrature-  
based  
moment  
methods

D. L.  
Marchisio

GPBE

Velocity  
disperse  
phase

Solution  
methods

Examples

Moment  
corruption

Spatial  
discretization  
in DQMOM

Conclusions

# EXAMPLES: SIMULATION PARTICLE LADEN FLOWS, FLUIDIZATION, GAS-LIQUID STIRRED TANKS AND BUBBLE COLUMNS



# Coupling DQMOM with LES/ASM/ADM

Quadrature-based moment methods

D. L. Marchisio

GPBE

Velocity disperse phase

Solution methods

Examples

Moment corruption

Spatial discretization in DQMOM

Conclusions

- In turbulent particle-laden flows a phenomenon called **turbophoresis** pushes particles towards the walls
- This is typically described with DNS simulations with Lagrangian particle tracking to represent polydispersity
- The GPBE (in the absence of aggregation, breakage or growth) for particle size only ( $\rightarrow$  after filtering) becomes:

$$\frac{\partial n}{\partial t} + \frac{\partial}{\partial \mathbf{x}} \cdot (\mathbf{U}_p(L)n) = 0 \quad \rightarrow \quad \frac{\partial \bar{n}}{\partial t} + \frac{\partial}{\partial \mathbf{x}} \cdot (\overline{\mathbf{U}_p(L)n}) = 0$$

- The evaluation of the advective term can be done with an **approximate deconvolution method (ADM)**,  $\mathbf{U}_p(L)$  is calculated with the **algebraic slip model (ASM)** whereas polydispersity is accounted for with **DQMOM**



# DQMOM-LES for particle-laden flow

Quadrature-based moment methods

D. L. Marchisio

GPBE

Velocity disperse phase

Solution methods

Examples

Moment corruption

Spatial discretization in DQMOM

Conclusions

DQMOM implementation in TransAT (ASCOMP) for particle-laden flow in channel with per. bound. cond.

Comparison between Lagrangian DNS (black) and LES/ASM/ADM with  $k = 0$  (red),  $k = 1$  (purple),  $k = 5$  (green), finer grid  $k = 0$  (blue), finer grid GR  $k = 5$  (brown)  
 $St = 0.2$   $St = 1.0$

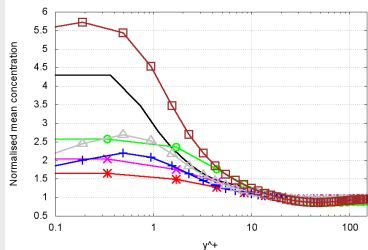
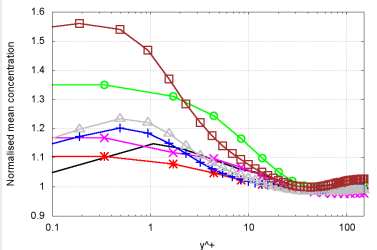

Icardi M., Marchisio D.L., Narayanan C., Fox R.O. Equilibrium-Eulerian LES Model for Poly-disperse Particle-laden Channel Flow. INTERNATIONAL JOURNAL OF NONLINEAR SCIENCES AND NUMERICAL SIMULATION. in press,



# DQMOM-LES for particle-laden flow

Contour plots of the mean particle size  $d_{32}$  and PSD in the center of the channel and near the wall (DQMOM approximations, red line, and reconstructed PSD, blue line)

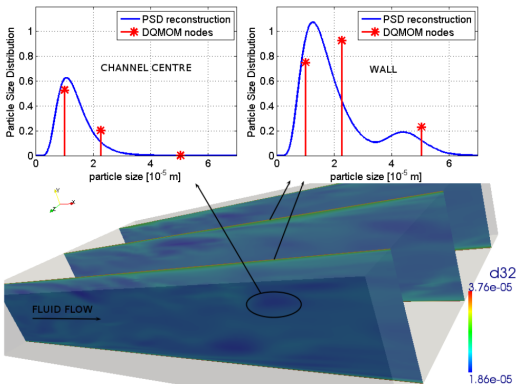



# QMOM/multi-fluid for fluidization

Quadrature-  
based  
moment  
methods

D. L.  
Marchisio

GPBE

Velocity  
disperse  
phase

Solution  
methods

Examples

Moment  
corruption

Spatial  
discretization  
in DQMOM

Conclusions

- In fluidized suspensions particles are segregated (or mixed) according to their size: **flotsam** and **jetsam**
- This can be described by using QMOM ( $N = 2$ ) for size coupled with a multi-fluid model (in Fluent) with one continuous phase (gas) plus two disperse phases (nodes 1 and 2)<sup>2</sup>

- The resulting transport equation for the moment of order  $k$  (again without aggregation nor breakage) is:

$$\frac{\partial M_k}{\partial t} + \frac{\partial}{\partial \mathbf{x}} \cdot (\mathbf{U}_p^k M_k) = 0$$

- The velocity for the moment of order  $k$  is defined (with two nodes) as follows:

$$\mathbf{U}_p^k = \frac{w_1 \mathbf{U}_p(L_1) L_1^k + w_2 \mathbf{U}_p(L_2) L_2^k}{M_k}$$

<sup>2</sup> Mazzei, Marchisio, Lettieri, 2012. AIChE J., 58, 3054-3069.





# QMOM/multi-fluid for fluidization

$M_0$  (top) and  $M_1$  (bottom) from 5, 10 and 15 cm/s (left to right)

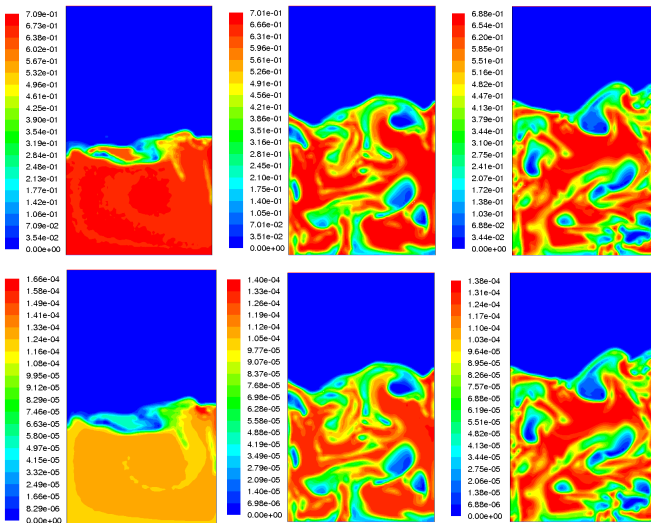

Quadrature-based moment methods

D. L. Marchisio

GPBE

Velocity disperse phase

Solution methods

Examples

Moment corruption

Spatial discretization in DQMOM

Conclusions



# QMOM/multi-fluid for fluidization

Quadrature-based moment methods

D. L. Marchisio

GPBE

Velocity disperse phase

Solution methods

Examples

Moment corruption

Spatial discretization in DQMOM

Conclusions

Top and bottom layers at 5 cm/s (left) and 15 cm/s (right)

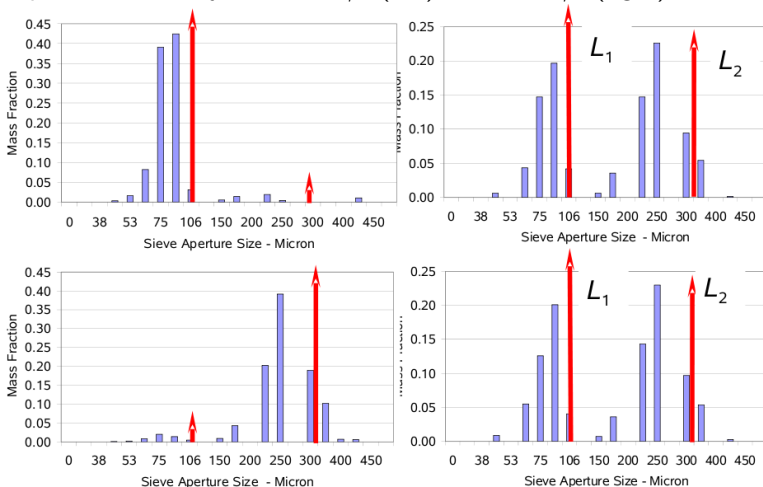



# CQMOM for a stirred tank

Quadrature-based moment methods

D. L. Marchisio

GPBE

Velocity disperse phase

Solution methods

Examples

Moment corruption

Spatial discretization in DQMOM

Conclusions

Standard rushton turbine / gassing rate 0.018 - 0.093 vvm / stirring rate 155 - 250 rpm / reactor volume  $\approx$  180 l resulting in hold-up values up to 1.5 % / Fluent

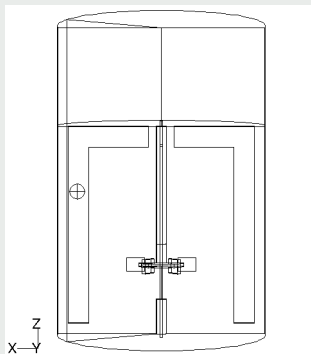
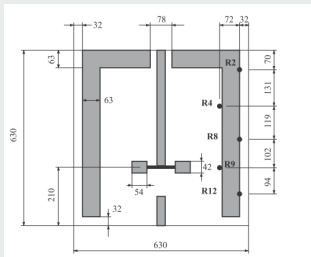

Laakkonen M, Alopaeus V, Aittamaa J. Chem. Eng. Sci. 2006, 61: 218-228.



# CQMOM for a stirred tank

Quadrature-based moment methods

D. L. Marchisio

GPBE

Velocity disperse phase

Solution methods

Examples

Moment corruption

Spatial discretization in DQMOM

Conclusions

## Results and comparison with experimental data

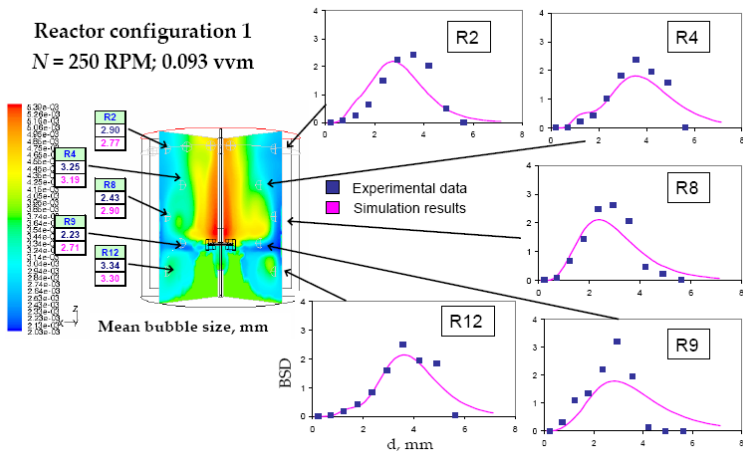



# QMOM/CQMOM for a bubble column

Quadrature-based moment methods

D. L. Marchisio

GPBE

Velocity disperse phase

Solution methods

Examples

Moment corruption

Spatial discretization in DQMOM

Conclusions

## Implementation of QMOM/CQMOM in openFOAM (compressibleTwoPhaseEulerFoam v 2.1)

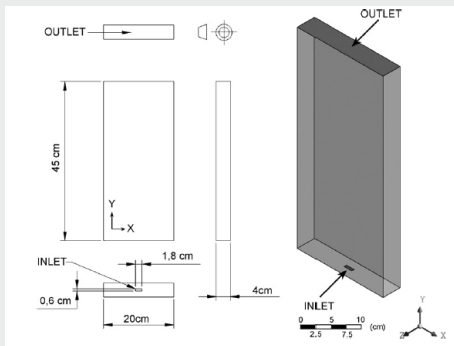

Simulation of the bubble column investigated by Diaz et al., 2008. Chem. Eng. J., 139, 363-379



# QMOM/CQMOM for a bubble column

Quadrature-  
based  
moment  
methods

D. L.  
Marchisio

GPBE

Velocity  
disperse  
phase

Solution  
methods

Examples

Moment  
corruption

Spatial  
discretization  
in DQMOM

Conclusions

Color mean bubble size  
Implementation of QMOM/CQMOM in openFOAM



# QMOM/CQMOM for a bubble column

Quadrature-based moment methods

D. L. Marchisio

GPBE

Velocity disperse phase

Solution methods

Examples

Moment corruption

Spatial discretization in DQMOM

Conclusions

Mean bubble size (m)  
2.4 mm/s    11.9 mm/s    21.3 mm/s

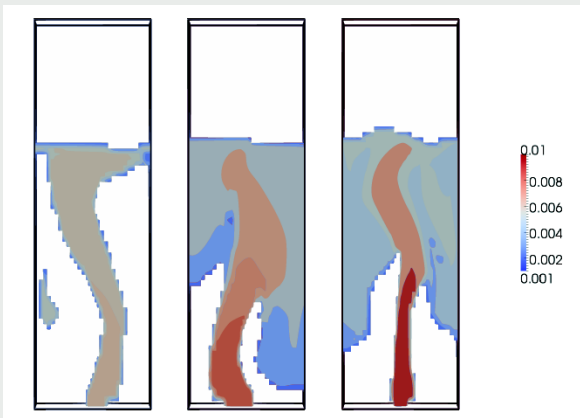



# QMOM/CQMOM for a bubble column

Quadrature-based moment methods

D. L. Marchisio

GPBE

Velocity disperse phase

Solution methods

Examples

Moment corruption

Spatial discretization in DQMOM

Conclusions

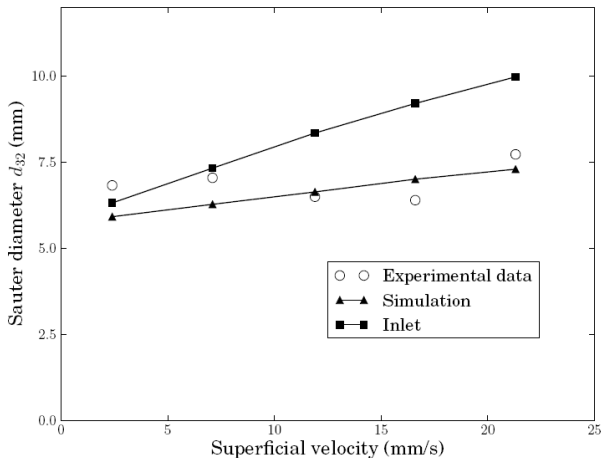





# QMOM/CQMOM for a bubble column

Quadrature-based moment methods

D. L. Marchisio

GPBE

Velocity disperse phase

Solution methods

Examples

Moment corruption

Spatial discretization in DQMOM

Conclusions

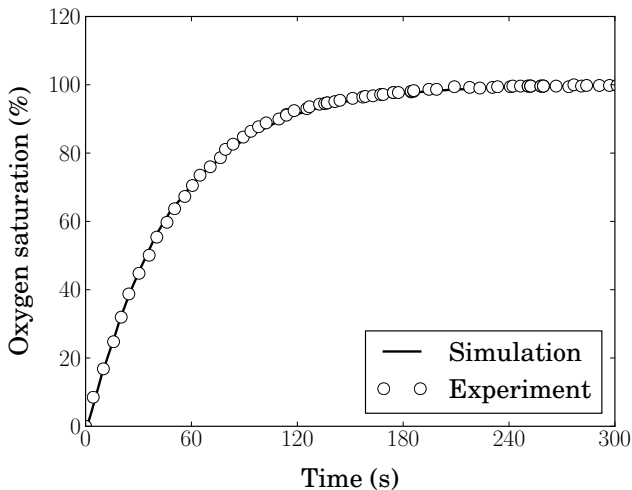



Quadrature-  
based  
moment  
methods

D. L.  
Marchisio

GPBE

Velocity  
disperse  
phase

Solution  
methods

Examples

**Moment  
corruption**

Spatial  
discretization  
in DQMOM

Conclusions

# ISSUES RELATED TO MOMENT CORRUPTION: QMOM/CQMOM



# Spatial discretization in QMOM

Quadrature-based moment methods

D. L. Marchisio

GPBE

Velocity disperse phase

Solution methods

Examples

Moment corruption

Spatial discretization in DQMOM

Conclusions

- As we previously mentioned given a distribution  $n(L)$  the moments  $M_k$  represent physical measurable quantities
- For example  $M_0$  represents the total number of particles per unit volume
- The first-order moment is related to the mean particle size:  $M_1/M_0$
- The second order moment is related to the variance:  $M_2 - M_1^2/M_0$
- The variance must be positive, therefore  $M_2 \geq M_1^2/M_0$
- **Since the moments are linked they must respect some constraints**, which are intuitive for lower-order moments and more exotic for higher-order moments



# Spatial discretization in QMOM

Quadrature-  
based  
moment  
methods

D. L.  
Marchisio

GPBE

Velocity  
disperse  
phase

Solution  
methods

Examples

Moment  
corruption

Spatial  
discretization  
in DQMOM

Conclusions

**Necessary validity condition: convexity of function  $\ln(m_k)$   
with respect to  $k$**

$$m_k m_{k-2} - m_{k-1}^2 \geq 0$$

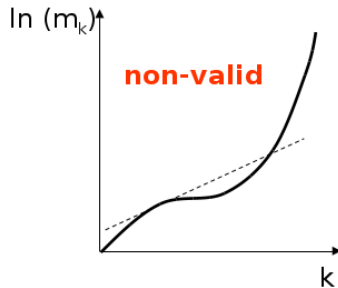
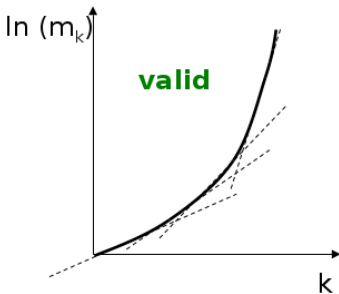



# Spatial discretization in QMOM

Quadrature-based moment methods

D. L. Marchisio

GPBE

Velocity disperse phase

Solution methods

Examples

Moment corruption

Spatial discretization in DQMOM

Conclusions

- A moment set can be corrupted by time and space discretization schemes:

$$\frac{\partial M_k}{\partial t} + U_P \frac{\partial M_k}{\partial x} = \bar{S}_k \rightarrow \frac{dM_k^P}{dt} = \bar{S}_k^P - \frac{U_P}{\Delta x} (M_k^e - M_k^w)$$

- With first-order upwind  $M_k^e = M_k^P$  and  $M_k^w = M_k^W$

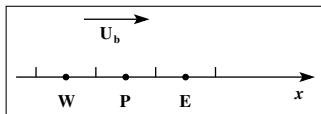

- Spatial discretization schemes based on first-order upwind always result in VALID moments. Higher-order schemes (second-order upwind, QUICK, MUSCL) always result in INVALID moments.



# Spatial discretization in QMOM

Quadrature-based moment methods

D. L. Marchisio

GPBE

Velocity disperse phase

Solution methods

Examples

Moment corruption

Spatial discretization in DQMOM

Conclusions

## CORRECTION ALGORITHM BY MCGRAW

- 1 Build difference table and check if  $\mathbf{d}_2$  is negative
- 2 Identify moment order  $k$  that causes the biggest change in  $\mathbf{d}_3$
- 3 Change moment (by multiplying it for a constant) in order to MINIMIZE  $\mathbf{d}_3$
- 4 Go back to point 1

## CORRECTION ALGORITHM BY WRIGHT

- 1 Build difference table and check if  $\mathbf{d}_2$  is negative
- 2 Replace moments with those of a log-normal distribution with 
$$\mu = \frac{j}{ij-i^2} \ln \left( \frac{M_i}{M_0} \right) + \frac{i}{ij-j^2} \ln \left( \frac{M_j}{M_0} \right) \text{ and}$$
$$\sigma^2 = \frac{1}{1-i/j} \left[ \frac{2}{j^2} \ln \left( \frac{M_j}{M_0} \right) - \frac{2}{ij} \ln \left( \frac{M_i}{M_0} \right) \right]$$



# Spatial discretization in QMOM

Quadrature-based moment methods

D. L. Marchisio

GPBE

Velocity disperse phase

Solution methods

Examples

Moment corruption

Spatial discretization in DQMOM

Conclusions

## Moment corruption detection and correction

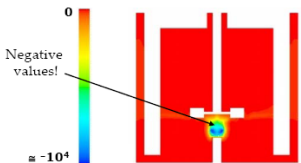

$m_2$  without correction

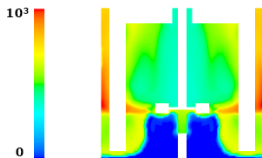

$m_2$  with correction

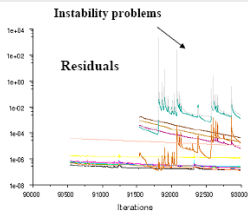

Instability problems

Residuals

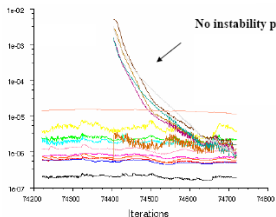

No instability problems



Quadrature-  
based  
moment  
methods

D. L.  
Marchisio

GPBE

Velocity  
disperse  
phase

Solution  
methods

Examples

Moment  
corruption

**Spatial  
discretization  
in DQMOM**

Conclusions

# ISSUES RELATED TO SPATIAL DISCRETIZATION WITH DQMOM: DQMOM-FC





# Spatial discretization in DQMOM

Quadrature-based moment methods

D. L. Marchisio

GPBE

Velocity disperse phase

Solution methods

Examples

Moment corruption

Spatial discretization in DQMOM

Conclusions

- The original GPBE is:

$$\frac{\partial n}{\partial t} + \frac{\partial}{\partial \mathbf{x}} \cdot (\mathbf{U}_p n) = S$$

- With **DQMOM** the NDF is described in terms of weights,  $w_\alpha$ , and nodes,  $L_\alpha - \phi_\alpha$ , so that some moments  $M_{k,l}$  are correctly predicted:

$$\frac{\partial w_\alpha}{\partial t} + \frac{\partial}{\partial \mathbf{x}} \cdot (\mathbf{U}_{p,\alpha} w_\alpha) = a_\alpha$$

however this does not conserve moments (in FV codes)

- Therefore convection is treated as a source term:

$$\frac{\partial n}{\partial t} = -\frac{\partial}{\partial \mathbf{x}} \cdot (\mathbf{U}_p n) + S$$

- Resulting in (**DQMOM-Fully-Conservative**):

$$\frac{\partial w_\alpha}{\partial t} = a_\alpha^* + a_\alpha$$



# Spatial discretization in DQMOM

Quadrature-based moment methods

D. L. Marchisio

GPBE

Velocity disperse phase

Solution methods

Examples

Moment corruption

Spatial discretization in DQMOM

Conclusions

Oxygen concentration in gas phase ( $\text{mol m}^{-3}$ )  
No mass transfer

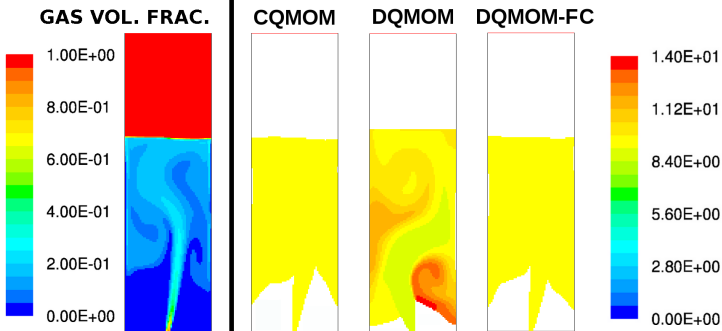

Results obtained with the commercial code Fluent



Quadrature-  
based  
moment  
methods

D. L.  
Marchisio

GPBE

Velocity  
disperse  
phase

Solution  
methods

Examples

Moment  
corruption

Spatial  
discretization  
in DQMOM

Conclusions

# CONCLUSIONS



# Conclusions and next steps

Quadrature-  
based  
moment  
methods

D. L.  
Marchisio

GPBE

Velocity  
disperse  
phase

Solution  
methods

Examples

Moment  
corruption

Spatial  
discretization  
in DQMOM

Conclusions

- The simulation of polydisperse multiphase systems can be efficiently done at the macroscale
- Quadrature-based moment methods (QBMM) can be used for reconstructing the NDF and overcoming the closure problem
- They combine accuracy and computational efficiency
- Currently implemented in Fluent, TransAT and openFoam
- DQMOM has many issues (the ones related to spatial discretization in finite volume codes are fixed by using **DQMOM-FC**)
- QMOM/CQMOM are way more efficient but attention should be paid to **moment realizability**/corruption
- Very important is also the problem of **quadrature realizability**
- Future work: development of mesoscale models for real systems



## Quadrature- based moment methods

D. L.  
Marchisio

GPBE

Velocity  
disperse  
phase

Solution  
methods

Examples

Moment  
corruption

Spatial  
discretization  
in DQMOM

Conclusions



# CQMOM for a stirred tank

Quadrature-based moment methods

D. L. Marchisio

GPBE

Velocity disperse phase

Solution methods

Examples

Moment corruption

Spatial discretization in DQMOM

Conclusions

## Results and comparison with experimental data

$N = 157 \text{ RPM}; 0.052 \text{ vvm}$

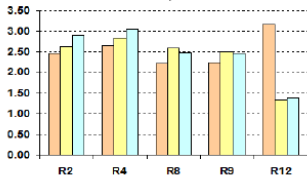

$N = 250 \text{ RPM}; 0.052 \text{ vvm}$

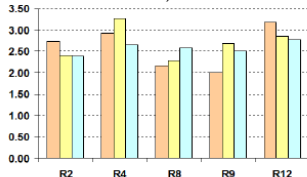

$N = 250 \text{ RPM}; 0.072 \text{ vvm}$

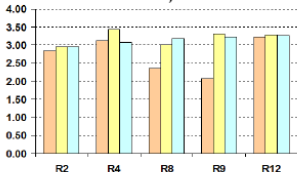

- Experimental
- Simulation (45°)
- Simulation (135°)

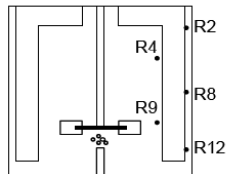



# CQMOM for a stirred tank

Quadrature-based moment methods

D. L. Marchisio

GPBE

Velocity disperse phase

Solution methods

Examples

Moment corruption

Spatial discretization in DQMOM

Conclusions

Experimental and simulated mean bubble size (mm) in five different points of the stirred tank.

SR, RPM	GR, vvm		R2	R4	R8	R9	R12
155	0.018	Exp.	2.37	2.48	2.29	1.65	3.31
		Sim.	3.10	2.56	2.57	2.63	3.09
220	0.041	Exp.	2.56	3.34	2.57	1.76	3.81
		Sim.	2.66	3.04	2.47	2.50	3.20
220	0.052	Exp.	2.74	2.93	2.17	2.01	3.18
		Sim.	2.45	3.31	2.55	2.65	3.57
250	0.093	Exp.	2.96	3.25	2.43	2.23	3.33
		Sim.	2.56	3.27	2.59	3.05	3.35



# CQMOM for a stirred tank

Quadrature-based moment methods

D. L. Marchisio

GPBE

Velocity disperse phase

Solution methods

Examples

Moment corruption

Spatial discretization in DQMOM

Conclusions

## Global gas hold-up for 390 rpm

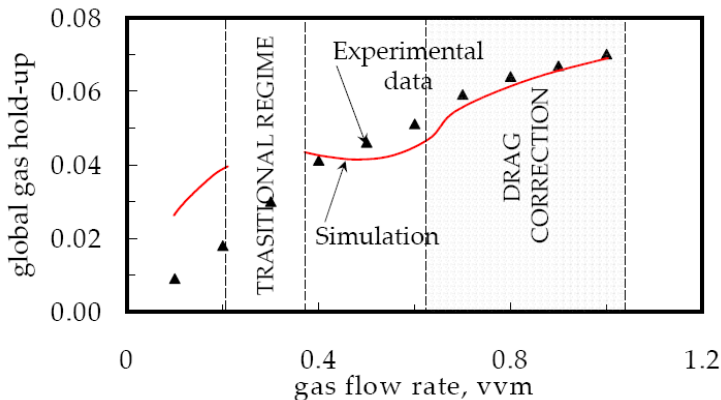





# CQMOM for a stirred tank

Quadrature-based moment methods

D. L. Marchisio

GPBE

Velocity disperse phase

Solution methods

Examples

Moment corruption

Spatial discretization in DQMOM

Conclusions

Specific surface area of bubbles ( $\text{m}^{-1}$ ) at 250 rpm and 0.052 vvm (left) and at 155 rpm and 0.018 vvm (right)

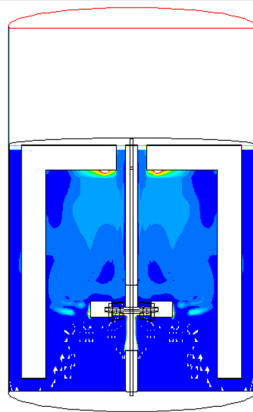
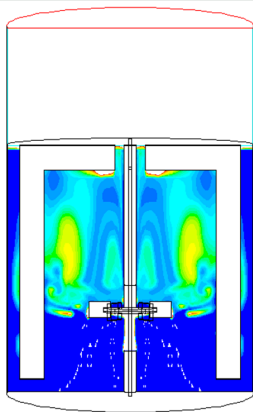
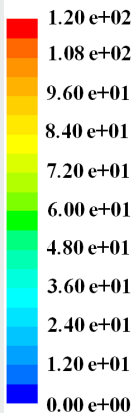



# CQMOM for a stirred tank

Mass transfer coefficient  $k_l$  ( $\text{m s}^{-1}$ ) at 250 rpm and 0.052 vvm (left) and at 155 rpm and 0.018 vvm (right)

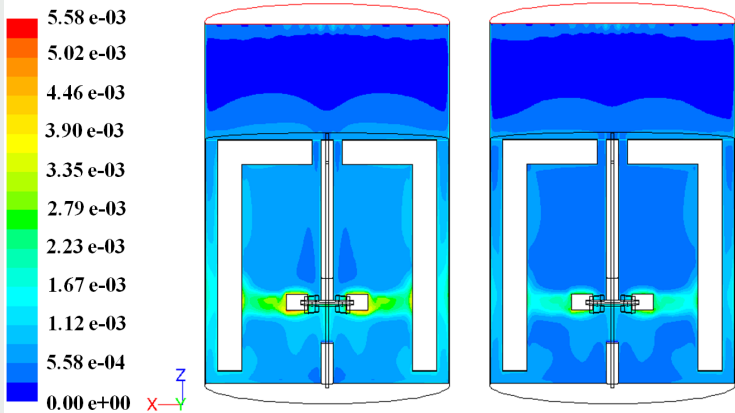

Quadrature-based moment methods

D. L. Marchisio

GPBE

Velocity disperse phase

Solution methods

Examples

Moment corruption

Spatial discretization in DQMOM

Conclusions



# CQMOM for a stirred tank

Quadrature-based moment methods

D. L. Marchisio

GPBE

Velocity disperse phase

Solution methods

Examples

Moment corruption

Spatial discretization in DQMOM

Conclusions

Oxygen concentration ( $\text{mol m}^{-3}$ ) in the gas (left) and in the liquid (right) at 250 rpm and 0.052 vvm

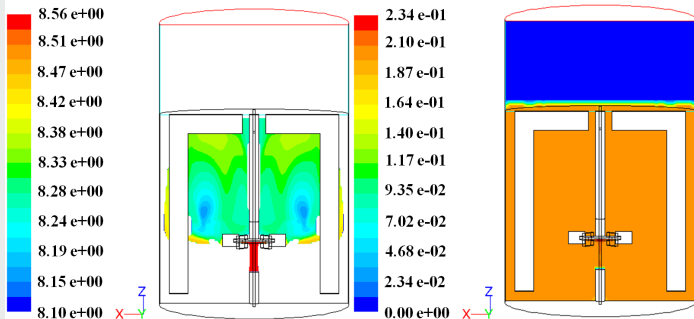



# DSMC for a stirred tank

Quadrature-based moment methods

D. L. Marchisio

GPBE

Velocity disperse phase

Solution methods

Examples

Moment corruption

Spatial discretization in DQMOM

Conclusions

## Effect number of comp. on gas hold-up and Sauter diameter

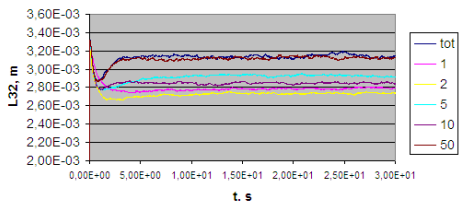
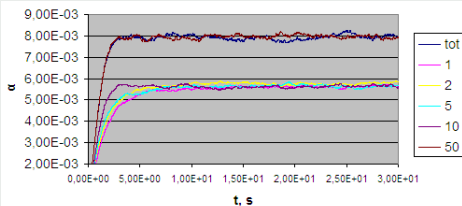



# DSMC for a stirred tank

Quadrature-based moment methods

D. L. Marchisio

GPBE

Velocity disperse phase

Solution methods

Examples

Moment corruption

Spatial discretization in DQMOM

Conclusions

Let us now consider a realistic stirred tank

- Rushton turbine (six blades) - reactor volume 15,3 l
- Gassing rate  $\approx 0,062$  l/s; stirring rate 100-300 rpm
- Flow field simulation ANSYS/Fluent13 - DSMC in-house code

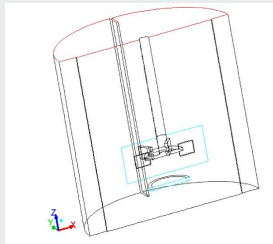
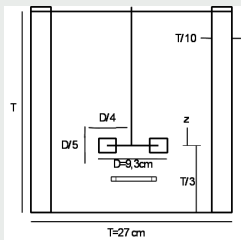

Wu & Patterson, Chem. Eng. Sci., 44, 2207-2221, 1989



# DSMC for a stirred tank

Quadrature-based moment methods

D. L. Marchisio

GPBE

Velocity disperse phase

Solution methods

Examples

Moment corruption

Spatial discretization in DQMOM

Conclusions

Compartment model  
 Tot. numb. comp.      Turb. diss. rate  $m^2s^{-3}$        $N \approx 2$

1			6			16			26		
2			7			17			27		
3			8			18			28		
36	41	46	9			19	29				
37	42	47	10			20	30				
38	43	48	11			21	31				
39	44	49	12			22	32				
40	45	50	13			23	33				
4			14			24			34		
5			15			25			35		

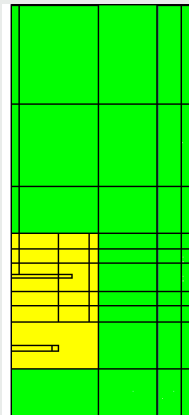
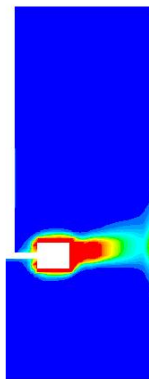
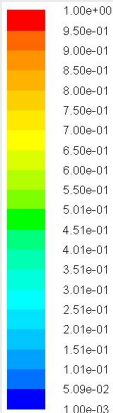



# DSMC for a stirred tank

Quadrature-based moment methods

D. L. Marchisio

GPBE

Velocity disperse phase

Solution methods

Examples

Moment corruption

Spatial discretization in DQMOM

Conclusions

## Compartment model

Tot. numb. comp.

Turb. diss. rate  $m^2s^{-3}$

$N \approx 5$

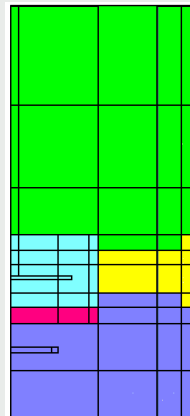
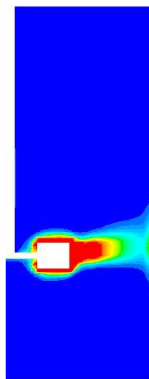
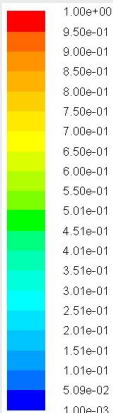
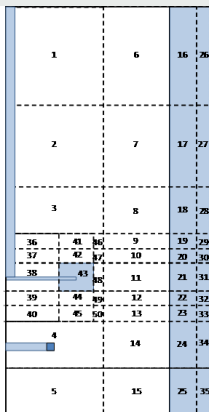



# DSMC for a stirred tank

Quadrature-  
based  
moment  
methods

D. L.  
Marchisio

GPBE

Velocity  
disperse  
phase

Solution  
methods

Examples

Moment  
corruption

Spatial  
discretization  
in DQMOM

Conclusions

Compartment model

Tot. numb. comp.

Turb. diss. rate  $m^2s^{-3}$

$N \approx 10$

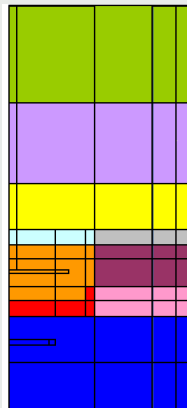
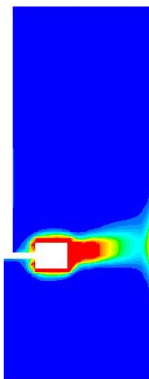
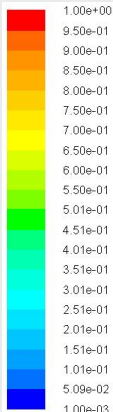
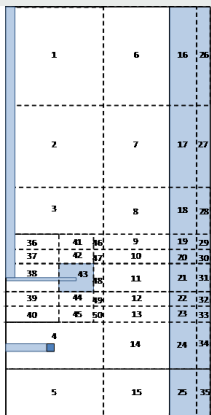





# DSMC for a stirred tank

Quadrature-based moment methods

D. L. Marchisio

GPBE

Velocity disperse phase

Solution methods

Examples

Moment corruption

Spatial discretization in DQMOM

Conclusions

## Bubble size-composition in two regions

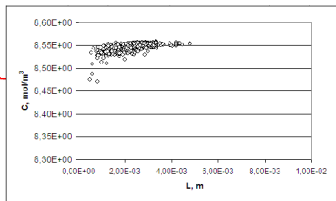
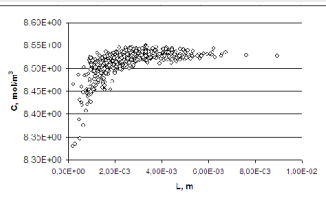
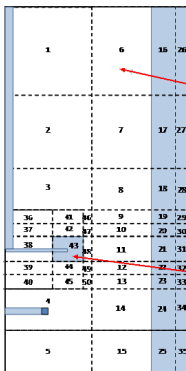



# DSMC for a stirred tank

Quadrature-based moment methods

D. L. Marchisio

GPBE

Velocity disperse phase

Solution methods

Examples

Moment corruption

Spatial discretization in DQMOM

Conclusions

Effect of chemical reaction ( $Ha = \sqrt{kC_{O_2}D}/k_l$ )

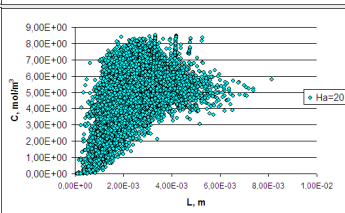
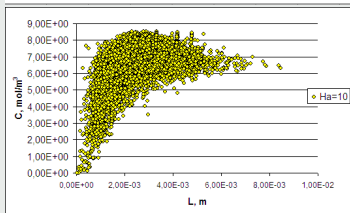
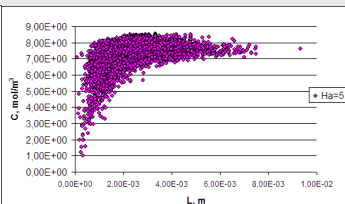
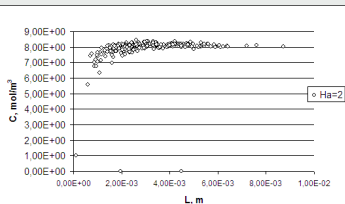



# Comparison DSMC with CQMOM/DQMOM

Quadrature-based moment methods

D. L. Marchisio

GPBE

Velocity disperse phase

Solution methods

Examples

Moment corruption

Spatial discretization in DQMOM

Conclusions

Table: Mean percentage error of QBMM for the examined case at steady-state.

	$M_{0,0}$	$M_{1,0}$	$M_{2,0}$	$M_{3,0}$	$M_{4,0}$	$M_{5,0}$	$M_{6,0}$	$M_{7,0}$
$N=2$	10.1	7.9	4.6	0.5	6.5	22.3	38.3	50.1
$N=3$	7.9	5.2	2.3	0.5	3.3	6.2	8.2	6.9
$N=4$	7.7	5.1	2.4	0.4	3.3	6.4	9.5	12.7

	$M_{0,1}$	$M_{1,1}$	$M_{2,1}$	$M_{3,1}$
$N=2$	2.1	6.5	21.4	44.6
$N=3$	1.9	1.8	4.7	6.2
$N=4$	3.2	1.7	3.4	6.4



# Growth rate and mass transfer meso-scale models

Quadrature-based moment methods

D. L. Marchisio

GPBE

Velocity disperse phase

Solution methods

Examples

Moment corruption

Spatial discretization in DQMOM

Conclusions

Analogously the mass transfer coefficient is calculated with Danckwerts theory<sup>3</sup>:

$$k_L = 1.13 \mathcal{D}^{0,5} \left( \frac{\epsilon \rho_c}{\mu_c} \right)^{0,25}$$

Consequently the mass transfer rate reads as follows:

$$\dot{\phi}_b = k_L k_a L^2 \left( C_c - H \frac{\phi_b}{k_v L^3} \right)$$

whereas the rate of change of bubble size:

$$G = \frac{2k_L M_w}{\rho_b} \left( C_c - H \frac{\phi_b}{k_v L^3} \right)$$

---

<sup>3</sup>J.C. Lamont & D.S. Scott, *AIChE J.* **16** (1970) 513-519; P.V. Danckwerts, *Ind. Eng. Chem.* **43** (1951) 1460-1467.



# Discontinuous term meso-scale model

Quadrature-  
based  
moment  
methods

D. L.  
Marchisio

GPBE

Velocity  
disperse  
phase

Solution  
methods

Examples

Moment  
corruption

Spatial  
discretization  
in DQMOM

Conclusions

## Coalescence kernel

A kernel written in terms of bubble size is used<sup>a</sup>:

$$a(\lambda, L) = 0.88 \epsilon^{1/3} (\lambda + L)^2 (\lambda^{2/3} + L^{2/3})^{1/2} \eta(\lambda, L)$$

where it is implicitly assumed that **turbulent fluctuations are the driving force for bubble collisions.**

The coalescence efficiency  $\eta(\lambda, L)$  can be written as follows<sup>b</sup>:

$$\eta(\lambda, L) = \exp \left( -6 \cdot 10^9 \frac{\mu_c \rho_c \epsilon}{\sigma^2} \left( \frac{\lambda L}{\lambda + L} \right)^4 \right)$$

<sup>a</sup>M.J. Prince & H.W. Blanch, *AIChE J.* **36** (1990) 1485-1499.

<sup>b</sup>C.A. Coulaloglou & L.L. Tavlarides, *Chem. Eng. Sci.* **32** (1977) 1289-1297.



# Discontinuous term meso-scale model

Quadrature-based moment methods

D. L. Marchisio

GPBE

Velocity disperse phase

Solution methods

Examples

Moment corruption

Spatial discretization in DQMOM

Conclusions

## Breakage kernel

$$b(L) = 6.0 \epsilon^{1/3} \operatorname{erfc} \left( \sqrt{0.04 \frac{\sigma}{\rho_c \epsilon^{2/3} L^{5/3}} + 0.01 \frac{\mu_c}{\sqrt{\rho_c \rho_b} \epsilon^{1/3} L^{4/3}}} \right)$$

## Daughter distribution function

Generic  $\beta$ -PDF for bubble size (and bubble composition) where  $C = 2$  for binary breakage:

$$P(L|\lambda) = \frac{1}{12} (C+1)^2 (C+2)^2 (C+3)^2 (C+4)^2 \times \frac{L^2}{\lambda^3} \left( \frac{L^3}{\lambda^3} \right)^2 \left( 1 - \frac{L^3}{\lambda^3} \right)^C$$

M. Laakkonen, P. Moilanen, V. Alopaeus & J. Aittamaa, *Chem. Eng. Sci.* **62** (2007) 721-740; R. Andersson & B. Andersson, *AIChE J.* **52** (2006) 2020-2030.



# Comparison DSMC with CQMOM/DQMOM

Quadrature-  
based  
moment  
methods

D. L.  
Marchisio

GPBE

Velocity  
disperse  
phase

Solution  
methods

Examples

Moment  
corruption

Spatial  
discretization  
in DQMOM

Conclusions

- With DSMC the evolution of the population of particles is represented through its stochastic equivalent (with  $N \approx 100$  notional particles)
- With QMOM/CQMOM/DQMOM the evolution is tracked deterministically with  $N \approx 3 - 6$  macro-classes!
- These macro-classes are centered at the quadrature nodes
- Therefore all the unclosed terms appearing in the equations for the moments are closed with great accuracy
- The two distributions share the same moments of the NDF:

$$M_{k,l}(t, \mathbf{x}) = \iint n(t, \mathbf{x}, L, \phi_p) L^k \phi_p^l dL d\phi_p$$

- Sharing the same moments does not imply that the **quadrature is realizable** (for example for specific applications some moments have to be included!)



# Differences between QMOM/CQMOM/DQMOM

Quadrature-  
based  
moment  
methods

D. L.  
Marchisio

GPBE

Velocity  
disperse  
phase

Solution  
methods

Examples

Moment  
corruption

Spatial  
discretization  
in DQMOM

Conclusions

- When transporting moments (**QMOM/CQMOM**) the governing equations are solved for CONSERVATIVE variables, ensuring the conservation of important properties (in finite volume codes)
- Time and space discretization can CORRUPT a moment set causing instabilities when the inversion algorithm is applied
- Moment corruption is significant when adopting higher-order spatial discretization (and interpolation) schemes, whereas is limited when using first-order upwind schemes
- Several algorithms for detecting moment corruption and for correcting an invalid moment set have been developed<sup>4</sup>
- Also ad-hoc accurate spatial discretization schemes that preserve the consistency of a moment set have been developed

---

<sup>4</sup>M. Petitti, A. Nasuti, D.L. Marchisio, M. Vanni, G. Baldi, N. Mancini & F. Podenzani, *AIChE J.* **56** (2010) 36-53.





# Differences between QMOM/CQMOM/DQMOM

Quadrature-based moment methods

D. L. Marchisio

GPBE

Velocity disperse phase

Solution methods

Examples

Moment corruption

Spatial discretization in DQMOM

Conclusions

- When transporting the quadrature approximation (**DQMOM**) the equations are solved for PRIMITIVE variables making non-trivial the conservation of moments
- When numerical diffusion (always present in finite volume codes) dominates, even the conservation of low-order moments is not guaranteed
- The presence of diffusion generates spurious terms that must be corrected; the correction is readily calculated when the diffusion term is exactly known but in the case of numerical diffusion it can be very problematic<sup>5</sup>
- A new method has been developed: **DQMOM fully-conservative (DQMOM-FC)**
- Another well known problem of DQMOM is that the algorithm becomes unstable anytime two nodes of the quadrature approximation are characterized by the same values

<sup>5</sup>L. Mazzei, D.L. Marchisio & P. Lettieri, *Ind. Eng. Chem. Res.* **49** (2010) 5141-5152.



# Coupling QMOM/CQMOM/DQMOM with particle advection

Quadrature-based moment methods

D. L. Marchisio

GPBE

Velocity disperse phase

Solution methods

Examples

Moment corruption

Spatial discretization in DQMOM

Conclusions

- QMOM/CQMOM/DQMOM can be used with the assumption that all the particles are moving with the same average velocity<sup>6</sup>
- DQMOM can account for the fact that particles move with different velocities
- QMOM/CQMOM can also be used with particle velocity that depends on particle size, resulting in advection terms that are different for different moments<sup>7</sup>
- CQMOM/DQMOM can be used to describe the NDF including particle velocity<sup>8</sup>
- Moreover being most of these systems turbulent: DNS, LES or RANS can be used

<sup>6</sup> M. Petitti, et al., AIChE J. 56 (2010) 36-53.

<sup>7</sup> Mazzei, Marchisio, Lettieri, 2012. AIChE J., 58, 3054-3069.

<sup>8</sup> Buffo, Vanni and Marchisio, 2012. Chem. Eng. Sci. 70, 31-44.



# Spatial discretization in QMOM

Quadrature-based moment methods

D. L. Marchisio

GPBE

Velocity disperse phase

Solution methods

Examples

Moment corruption

Spatial discretization in DQMOM

Conclusions

A moment set is said to be valid, if the Hankel-Hadamard determinants are all non-negative:

$$\Delta_{k,l} = \begin{vmatrix} M_k & M_{k+1} & \cdots & M_{k+l} \\ M_{k+1} & M_{k+2} & \cdots & M_{k+l+1} \\ \vdots & \vdots & \ddots & \vdots \\ M_{k+l} & M_{k+l+1} & \cdots & M_{k+l+l} \end{vmatrix} \geq 0$$

for  $k = 0, 1$  and  $l \geq 0$ . A less stringent condition is that of convexity of the function  $\ln(M_k)$  with respect to  $k$ :

$$\frac{\ln(M_k) + \ln(M_{k-2})}{2} \geq \ln(M_{k-1}) \quad k = 1, 2, \dots;$$

or, equivalently,

$$M_k M_{k-2} - M_{k-1}^2 \geq 0 \quad k = 1, 2, \dots$$



# Spatial discretization in QMOM

The convexity of the function  $\ln(M_k)$  with respect to  $k$  can be easily verified by building a difference table of  $\ln(M_k)$ .

Example: VALID SET; moment of a Gaussian distribution ( $M_0 = 1, M_1 = 5, M_2 = 26, M_3 = 140, M_4 = 778, M_5 = 4450, M_6 = 26140, M_7 = 157400$ )

$k$	$d_0 = \ln(M_k)$	$d_1$	$d_2$	$d_3$
0	0	1.609	0.039	-0.0043
1	1.609	1.648	0.034	-0.0033
2	3.258	1.683	0.031	-0.0027
3	4.941	1.715	0.028	-0.0022
4	6.656	1.743	0.026	-0.0019
5	8.400	1.770	0.024	0
6	10.171	1.795	0	0
7	11.966	0	0	0

Quadrature-based moment methods

D. L. Marchisio

GPBE

Velocity disperse phase

Solution methods

Examples

Moment corruption

Spatial discretization in DQMOM

Conclusions



# Spatial discretization in QMOM

The convexity of the function  $\ln(M_k)$  with respect to  $k$  can be easily verified by building a difference table of  $\ln(M_k)$ .

Example: INVALID SET (modify the second-order moment from 26 to 25, corresponding to a difference of only 4 %)

k	$\mathbf{d}_0 = \ln(m_k)$	$\mathbf{d}_1$	$\mathbf{d}_2$	$\mathbf{d}_3$
0	0	1.609	0	0.113
1	1.609	1.609	0.113	-0.121
2	3.218	1.722	-0.007	0.036
3	4.941	1.715	0.028	-0.002
4	6.656	1.743	0.026	-0.001
5	8.400	1.770	0.024	0
6	10.171	1.795	0	0
7	11.966	0	0	0

Quadrature-based moment methods

D. L. Marchisio

GPBE

Velocity disperse phase

Solution methods

Examples

Moment corruption

Spatial discretization in DQMOM

Conclusions



# Spatial discretization in QMOM

Quadrature-  
based  
moment  
methods

D. L.  
Marchisio

GPBE

Velocity  
disperse  
phase

Solution  
methods

Examples

Moment  
corruption

Spatial  
discretization  
in QMOM

Conclusions

- Since it is very easy to CORRUPT the moments it is important to have CORRECTION algorithms
- If we transform the moment set so that  $\mathbf{d}_2$  is positive, we are almost sure that the moment set is valid
- But how positive?
- The moments of a log-normal distribution have the smallest  $\mathbf{d}_3$

$$n(L) = \frac{N_T}{\sigma\sqrt{2\pi}} \exp\left(\frac{-(\ln(L) - \mu)^2}{2\sigma^2}\right),$$

$$M_k = N_T \exp\left(k\mu + \frac{k^2\sigma^2}{2}\right),$$

- The log-normal distribution is the smoothest distribution!



# Spatial discretization in QMOM

Quadrature-  
based  
moment  
methods

D. L.  
Marchisio

GPBE

Velocity  
disperse  
phase

Solution  
methods

Examples

Moment  
corruption

Spatial  
discretization  
in DQMOM

Conclusions

- One solution would be to evaluate the moments at the faces  $M_k^e$  and  $M_k^w$  through the quadrature approximation
- We know the value of the moments at the center of the cells  $M_k^W$ ,  $M_k^P$ ,  $M_k^E$

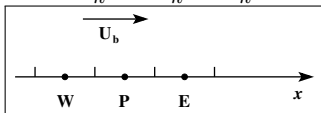

- From these moments we can evaluate the corresponding weights  $w_\alpha^P$  and abscissas  $L_\alpha^P$
- If weights and abscissas at the center of the face are interpolated with  $p^{\text{th}}$ -order spatial reconstruction the resulting moments will be valid
- This allows to improve the numerical accuracy preserving the moments!



# Spatial discretization in DQMOM

Quadrature-based moment methods

D. L. Marchisio

GPBE

Velocity disperse phase

Solution methods

Examples

Moment corruption

Spatial discretization in DQMOM

Conclusions

Steady state solution for bubbles undergoing aggregation and breakage →  
DQMOM/DQMOM-FE

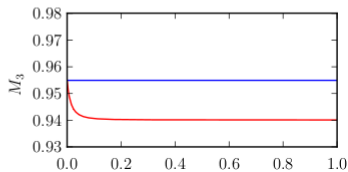
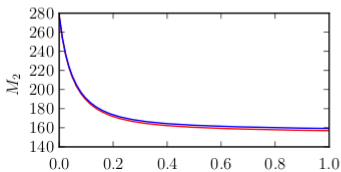
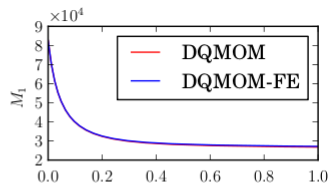
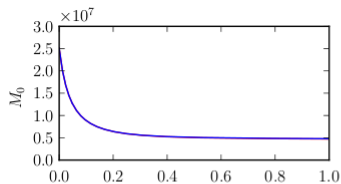





# CQMOM for a stirred tank

Quadrature-based moment methods

D. L. Marchisio

GPBE

Velocity disperse phase

Solution methods

Examples

Moment corruption

Spatial discretization in DQMOM

Conclusions

## Results and comparison with experimental data

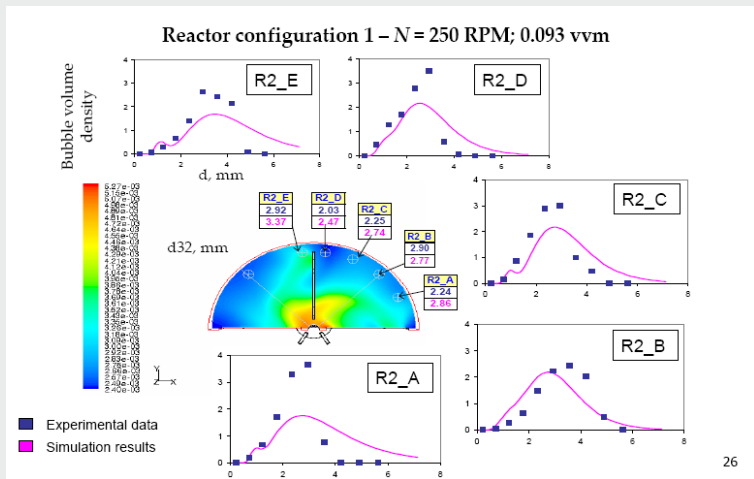



# CQMOM for a stirred tank

Quadrature-based moment methods

D. L. Marchisio

GPBE

Velocity disperse phase

Solution methods

Examples

Moment corruption

Spatial discretization in DQMOM

Conclusions

## Time evolution of oxygen concentration in the liquid

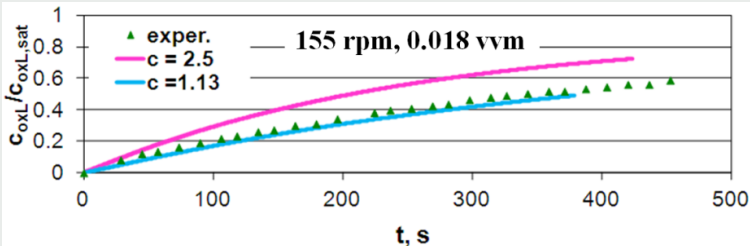
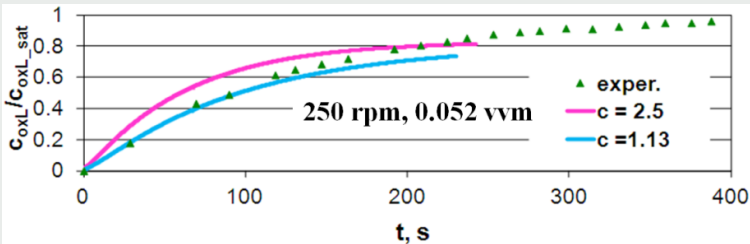



# CQMOM for a stirred tank

Quadrature-based moment methods

D. L. Marchisio

GPBE

Velocity disperse phase

Solution methods

Examples

Moment corruption

Spatial discretization in DQMOM

Conclusions

Example of the poor performance of fixed-constant bubble 3-D simulation for mass transfer!

