



Applied Models in Non-Equilibrium Statistical Mechanics

Paolo Alberto Adamo

paolo.adamo@polito.it

Supervisor: Prof. Lamberto Rondoni

Submitted for the degree of Doctor of Philosophy
DISMA - Politecnico di Torino
January 2013

Politecnico di Torino

PAOLO ALBERTO ADAMO, PH.D.

APPLIED MODELS IN NON EQUILIBRIUM STATISTICAL MECHANICS

Contents

| | | |
|----------|---|-----------|
| 1 | Introduction | 3 |
| 1.1 | The baker map | 4 |
| 1.2 | Molecular Dynamics | 6 |
| 1.2.1 | Thermostats | 7 |
| 1.2.2 | Gaussian thermostats | 8 |
| 1.2.3 | Nose'-Hoover thermostats | 8 |
| 1.3 | Large Deviations | 9 |
| 1.3.1 | Fluctuation Relations as response from large deviations | 14 |
| 1.3.2 | The Gallavotti-Cohen approach | 16 |
| 1.4 | The dissipation function | 19 |
| 1.4.1 | Evolution of probability distributions | 19 |
| 1.4.2 | Fluctuation relations for the dissipation function | 22 |
| 1.4.3 | Green-Kubo relations | 28 |
| 2 | Discrete Dynamical Systems: the multibaker map | 31 |
| 2.1 | The multibaker map | 32 |
| 2.2 | Time reversibility | 34 |

| | | |
|----------|---|-----------|
| 2.3 | Basins of attraction, dependence on ℓ | 43 |
| 2.4 | Phase Space contraction rate in the steady state | 46 |
| 2.5 | Analysis of the Transient FR | 51 |
| 2.6 | Conclusions | 53 |
| 3 | Applications of the dissipation function: t-mixing and the dissipation theorem | 59 |
| 3.1 | General setting | 60 |
| 3.2 | Response | 64 |
| 3.2.1 | General response: The Dissipation Theorem | 65 |
| 3.2.2 | Consistency conditions of DT | 68 |
| 3.3 | t-mixing and convergence to steady state | 68 |
| 3.4 | t-mixing as correlation decay | 73 |
| 3.5 | Time evolution of the different Dissipation Functions | 74 |
| 3.6 | Conclusions | 77 |
| 4 | Molecular Dynamics | 79 |
| 4.1 | Fluctuation Analysis in AURIGA gravitational antenna | 79 |
| 4.2 | General set-up | 81 |
| 4.2.1 | The spatial settings | 81 |
| 4.2.2 | The thermostating system | 83 |
| 4.3 | The dynamics: the Verlet algorithm | 85 |
| 4.4 | Observable definition: the system length | 86 |
| 4.4.1 | The annealing procedure | 87 |
| 4.4.2 | The equilibrium case | 88 |

| | | |
|----------|---|------------|
| 4.4.3 | The non-equilibrium case | 93 |
| 4.5 | The large deviation rate function | 97 |
| 4.6 | Conclusions | 100 |
| 5 | Conclusions | 103 |
| | Bibliography | 105 |

Abstract

The emerging of irreversible behaviour from time-reversible microscopic dynamics depicted by the thermodynamic description, is commonly referred as the *paradox of irreversibility*. The recent results obtained by Evans and Searls [16], namely the Fluctuation-Relations (FRs) for the Ω dissipation function, helped to shed light on the mechanism leading to the break in the time-simmetry, and opened new perspectives on the description of non-equilibrium systems. Deterministic dynamical systems such as the multibaker map or Molecular Dynamics (MD) simulations are useful models which may stress some of the crucial conditions which allow to derive irreversibility from reversible dynamics. Furthermore, in this framework, the dissipation function plays a fundamental role in describing the relaxation process of pertubated systems to equilibrium, which represents a fundamental issue in the field from the foundations of the kinetic theory.

In our researcch we have been investigating the response of different reversible dynamical systems set out of equilibrium. The approach followed was either on a pure theoretical (analytical) level, either through the analysis of specific applied models (Dynamical Systems and MD simulations).

In the first chapter we introduce briefly the theoretical framework and summarize the state of the art of the study of the FRs in non-equilibrium statistical mechanics. Moreover, in this section we describe briefly the mathematical tools which will appear in the body of the thesis.

In the second chapter we investigated a 2-dimensional reversible dynamical system known as multibaker map and test the validity of the Transient Fluctuation Rela-

tion under weakened hypothesis: we stress the fact that ergodicity of the equilibrium ensemble is a necessary condition for the FR to hold in the transient regime for dissipative dynamics.

In the third chapter we present a proof of the Dissipation Theorem and we analytically study the relaxation process to the equilibrium distribution of non-equilibrium statistical ensembles under the t-mixing hypothesis, for non-dissipative reversible dynamics.

Finally, in the fourth chapter, we present the results of MD simulations performed for a Lennard-Jones interacting particle-system subject to a thermal gradient kept in a non-equilibrium steady state. We underline the achievement of stable non-equilibrium configuration in our MD simulations and the validation of an extended FR according to the large deviation theory approach.

My PhD project was financially supported by CRT Foundation into the framework of the Lagrange project "Large fluctuations under thermal gradients with applications to gravitational detector" related to the "Rare-Noise Project: Auriga gravitational antenna", which is led by a consortium composed by INFN Padova, CNR Trento, Politecnico di Torino.

Chapter 1

Introduction

Fluctuation Relations (FRs) arised in the earlier 1990s in two different perspectives. One was based on physical intuition, as decay in correlation for physically relevant observables in systems of interacting particles: this approach allowed to verify the validity of such relations for systems of physical interest, from numerical simulations to experimental observations, leading to the understanding of the physics of systems obeying even to modified FRs [38, 31, 36]. On the other hand, a much more mathematical development aimed to identify the class of dynamical systems leading to FRs, although this approach may have led to assumptions which hardly appear immediately as physically consistent [38]. Although they tends to the same result, they hide subtle but important differences which are difficult to point out, since methods and formalism are very different. Our aim in this chapter is to introduce the physical framework and the mathematical tools we used in this work. Furthermore we focus in detail on the various assumptions that are required for the two approaches and introduce the formalism which will appear in the body of this

thesis. We underline here the relevance of the connection between the dynamics and the initial distribution, which will be further deepened in the third chapter.

1.1 The baker map

In the framework of chaos theory in non-equilibrium statistical mechanics we aim to introduce an illustrative application known as "Baker map".

A 2-Dimensional discrete-time dynamical system has the form

$$\begin{pmatrix} x_{n+1} \\ y_{n+1} \end{pmatrix} = A \cdot \begin{pmatrix} x_n \\ y_n \end{pmatrix}$$

Let us assume \mathcal{M} the phase space to be the unit square in the 2-Dimensions and $0 \leq x \leq 1$, $0 \leq y \leq 1$. The baker map is a continuous, reversible, area preserving and deterministic transformation mapping the phase space onto itself at each timestep.

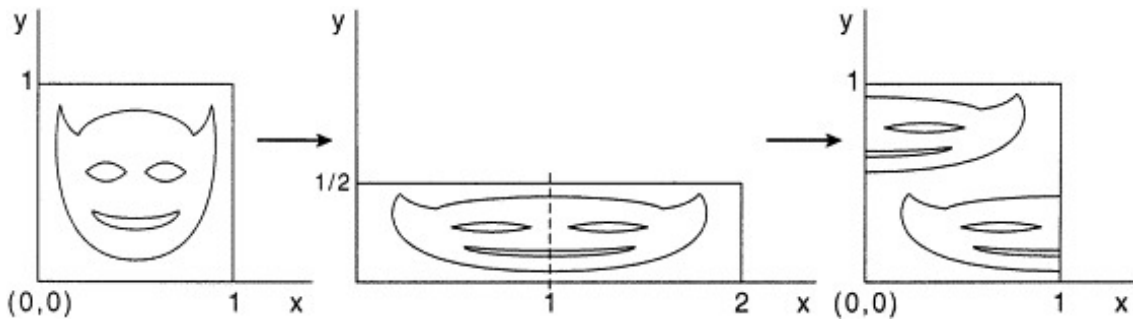

Figure 1.1: The baker's map

As discussed in the reference [7, 45] and shown in the figure 1.1, the transformation consists in two steps. First, the square unit gets stretched in the x -direction by a factor of 2 and contracted by a factor of 2 in the orthogonal direction. Then, the rectangle is split as illustrated in the drawing and placed on top of the first half, restoring the original shape:

$$(x_{n+1}, y_{n+1}) = A \cdot (x_n, y_n) = \begin{cases} (2x_n, y_n/2) & \text{for } x < 1/2 \\ (2x_n - 1, (y_n + 1)/2) & \text{for } x \geq 1/2 \end{cases}$$

The baker's transformation is an illustrative toy-model in which both ergodicity and mixing properties hold. Moreover it is possible to derive the Boltzmann equation and to show that the H-Theorem holds.

As we consider a density function $\rho(x, y)$ on the unit square, it satisfies the so called Frobenius-Perron equation, which basically consist in the Liouville equation for deterministic discrete time systems:

$$\rho_n(x, y) = \rho_{n-1}(A^{-1}x, A^{-1}y) \quad (1.1)$$

where

$$\rho_{n-1} = \begin{cases} \rho_{n-1}(x/2, 2y) & \text{for } x < 1/2 \\ \rho_{n-1}((x + 1/2), 2y - 1) & \text{for } x \geq 1/2 \end{cases}$$

Define a reduced distribution function that depends on x only:

$$W_n(x) = \int_0^1 \rho_n(x, y) dy = \int_0^{1/2} dy \rho_{n-1}\left(\frac{x}{2}, 2y\right) + \int_0^{1/2} dy \rho_{n-1}\left(\frac{x+1}{2}, 2y-1\right) \quad (1.2)$$

with a change of variable $y' = 2y$ in the first integral and to $y' = 2y - 1$ in the second integral it follows:

$$W_n(x) = \frac{1}{2} \int_0^1 dy' \left[\rho_{n-1}\left(\frac{x}{2}, y'\right) + \rho_{n-1}\left(\frac{x+1}{2}, y'\right) \right] = \frac{1}{2} \left[W_{n-1}\left(\frac{x}{2}\right) + W_{n-1}\left(\frac{x+1}{2}\right) \right] \quad (1.3)$$

which is the Boltzmann equation associated to the Baker's transformation.

It exist an equilibrium distribution W^0 which correspond to the uniform distribution

on the unit x -interval. Indeed, if W_n does not depend on x , then W_n remains constant in time.

As defining

$$H_n = \int_0^1 W_n(x) \log[W_n(x)] dx$$

it is possible ([7]) to derive the H-Theorem for the Baker's map in the form

$$H_{n+1} \leq H_n$$

Note that in the $n \rightarrow \infty$ limit, H remain constant if W_n remain constant, i.e. if it is the equilibrium distribution. An arbitrarily chosen initial condition relaxes to the same steady state density corresponding to the uniform (microcanonical) distributions [45]. From the point of view of the dynamics, in common with hamiltonian systems, the baker transformation preserve volumes and reversibility, nevertheless it is also possible to derive an isomorphism between the baker map and the Bernoulli sequence [20], proving that it also enjoys the properties of randomness and chaoticity of a sequence of coin tosses, which proves that discrete dynamical system may display stochastic-like properties.

1.2 Molecular Dynamics

Molecular Dynamics (MD) simulations is used as a technique for computing the equilibrium and non-equilibrium properties of a classical many body system. In this framework, by "classical" we mean that the dynamics follow the laws of classical newtonian mechanics. Through MD we aim to build simulations which are very similar to real experiments: in our simulations, the system size is given by the N

parameter which sets the numbers of the particles, and the interatomic potential is chosen as the classical Lennard-Jones potential [4].

The system is initialized in non-equilibrium conditions: each particle is set on the node of a cubic lattice in order to avoid cores overlap, with a random initial velocity such that the total momentum is zero. Under the effect of isokinetic dynamics the system equilibrates and equilibrium measurements can be performed. We remark that, in order to measure an observable in a Molecular Dynamics, it is necessary first to express this observable as a function of the positions and the momenta of the particles.

The necessary steps, which will be explained in detail in the third chapter, are:

- initialization of the system
- inter-particle force calculation
- integration of motion
- measurements

In order to perform simulations in non-microcanonical ensembles, we made use of thermostats, which are techniques to implement isokinetic dynamics which simulate the presence of a heat reservoir, which will be illustrated in the following section.

1.2.1 Thermostats

Deterministic thermostats are mathematical tools to model nonequilibrium steady states in fluids.

The Hamiltonian formalism of classical mechanics provides suitable dynamical equations for equilibrium systems. In order to incorporate the effects of a heat bath the Hamiltonian gets modified to consider the presence of fictitious thermodynamic forces driving the system away from equilibrium [4]. Such forces introduce a dissipation of the energy provided to the system to represent the mechanism of entropy production, and generate isokinetic dynamical conditions.

1.2.2 Gaussian thermostats

Consider a non-Hamiltonian N -particle system subjected to an external field with a isokinetic constraints which fixes the kinetic energy of the system $K = \sum_i p_i^2/2m$.

This would lead to the following dynamics:

$$\dot{q}_i = \frac{p_i}{m} \quad ; \quad \dot{p}_i = F_i^{int}(q) + F_i^{ext}(q) - \alpha(\Gamma)p_i$$

for the i -th particle, where $F_i^{int}(q)$ and $F_i^{ext}(q)$ denote respectively interparticle forces and external forces. In absence of external forces we may write [36], in isokinetic condition

$$\alpha(\Gamma) = \frac{1}{2K} \left(\sum_{i=1}^N \frac{p_i}{m} \cdot F_i^{int} \right)$$

constraining the isokinetic condition through a friction fictitious term.

1.2.3 Nose'-Hoover thermostats

We describe in the following another deterministic thermostat based upon a clever use of an extended Hamiltonian containing additional, artificial coordinates and velocities [31, 36].

Consider now a system of particles with internal energy H_0 exchanging heat with

a reservoir at temperature T . the interaction between the particles and the heat bath is represented by the variables (s, p_s) and the whole Hamiltonian is given by:

$$H = H_0 + 3NkT \log(s) + \frac{p_s}{2Q} = \frac{p^2}{2m} + \Psi(q) + 3NkT \log(s) + \frac{p_s}{2Q} \quad (1.4)$$

where Q is an effective mass related to the inertia of the heat bath.

Since for the variable set (q, p, s, p_s) the system is Hamiltonian, thus the distribution is therefore microcanonical in such frame.

Defining then

$$\tilde{q} = q \quad ; \quad \tilde{p} = \frac{p}{s} \quad ; \quad \tilde{t} = \int_0^t \frac{d\tau}{s} \quad ; \quad \tilde{s} = s \quad ; \quad \xi = \frac{p_s}{Q}$$

the partition function in the new variables become

$$\begin{aligned} Z &= \int \frac{1}{s} \delta(H - E) dq dp ds dp_s \\ &= \left[\int \frac{Q}{3NkT} e^{-\beta E} e^{-\beta Q \frac{\xi^2}{2}} dq dp ds d\xi \right] \int e^{-H_0(\tilde{q}, \tilde{p})} d\tilde{q} d\tilde{p} \end{aligned} \quad (1.5)$$

where $\beta = 1/kT$. In the new frame (\tilde{q}, \tilde{p}) the system is thus canonical with temperature T . The equations of motion in the new frame are then:

$$\frac{d\tilde{q}}{d\tilde{t}} = \frac{\tilde{p}}{m} \quad ; \quad \frac{d\tilde{p}}{d\tilde{t}} = F - \xi \tilde{p} \quad ; \quad \frac{d\xi}{d\tilde{t}} = \frac{1}{Q} \left(\frac{\tilde{p}^2}{m} - gkT \right) \quad (1.6)$$

where ξ is a phase variable with his own equation of motion. Notice that the Nose'-Hoover dynamics, coupled with the appropriate transformation $(q, p) \rightarrow (\tilde{q}, \tilde{p})$ guarantee the isokinetical constraint producing a canonical distribution.

1.3 Large Deviations

The Large Deviation Theory is based on the exponential decay approximation of probabilities fluctuations in random systems. As discussed in reference [42], given

a certain random variable A_n with integer index, the related probability $P(A_n)$ satisfies the *large deviation principle* if

$$\lim_{n \rightarrow \infty} -\frac{1}{n} \ln P(A_n) = I_b \quad (1.7)$$

exists, where I_b is called the *rate function*. The idea behind is to replace, in the $n \rightarrow \infty$ limit, P_n as a decaying exponential in n , such that we may write

$$P(A_n) \approx e^{-nI_b}. \quad (1.8)$$

Discret variables are often treated as they become continuous as n goes to infinity. The replacemnt of discrete random variables by continuous random variables is justified mathematically by the notion of weak convergence. Saying that the discrete random variable A_n with probability $P(A_n)$ converges weakly to the continuous random variable \tilde{A}_n with probabilty $p(\tilde{A}_n)$ means that the sum , in $n \rightarrow \infty$ limit, can be approximated by integrals, *i.e.*

$$\sum f(a)P(A_n = a) \approx \int f(a)p(\tilde{A}_n = a)da \quad (1.9)$$

where f is a continuous and bounded function. From now on we will use the sign " \succ " instead of " \approx " whenever we mean a random variable being approximated by a decaying exponential as $n \rightarrow \infty$, through the large deviation principle.

From a practical point of view, the derivation of the *rate function* basically consist of computing the probability distribution of a random variable in its asymptothic approximation form. In general, however, it may be difficult or even impossible to perform directly the calculations of the probability distribution in the asymp-

otic limit. In such cases, the **Gärtner-Ellis Theorem** provides a more general calculation path representing a fundamental result in the *Large Deviation Theory*.

Gärtner-Ellis Theorem. *Let A_n be a real variable, and define the scaled cumulant generating function of A_n as the limit:*

$$\lambda(k) = \lim_{n \rightarrow \infty} \frac{1}{n} \log \langle e^{nkA_n} \rangle \quad (1.10)$$

where $k \in \mathbb{R}$ and

$$\langle e^{nkA_n} \rangle = \int_{-\infty}^{\infty} e^{nka} P(A_n) da \quad (1.11)$$

If $\lambda(k)$ exist and is differentiable for all $k \in \mathbb{R}$, A_n satisfies the large deviation principle, i.e.

$$P(A_n \in da) \asymp e^{-nI(a)} \quad (1.12)$$

with *rate function*

$$I(a) = \sup_{k \in \mathbb{R}} [k \cdot a - \lambda(k)] \quad (1.13)$$

The transform defined by the supremum is an extension of the *Legendre transform* referred as the *Legendre-Fenchel transform*, although it is important to underline that not all the rate functions can be calculated by this theorem.

Rate functions are always positive and strictly convex functions. If $I(a)$ has a unique global minimum at a^* , thus

$$a^* = \lambda'(0) = \lim_{n \rightarrow \infty} \langle A_n \rangle. \quad (1.14)$$

we further have, if $I(a^*)$ is differentiable in a^* , $I'(a^*) = k(a^*) = 0$ and it corresponds to the value around which $P(A_n \in [a^*, a^* + da])$ gets more concentrated as

$n \rightarrow \infty$, i.e :

$$\lim_{n \rightarrow \infty} P(A_n \in [a^*, a^* + da]) = 1 \quad (1.15)$$

which is called the *equilibrium state*. Rate functions may have other local minima that correspond to the so-called 'metastable' values of A_n . In case $I(a)$ have a single global minimum and it's twice differentiable in a^* , approximating $I(a)$ by Taylor expansion such that

$$I(a) \asymp \frac{1}{2} I''(a^*) (a - a^*)^2 \quad (1.16)$$

leads to the Gaussian approximation

$$P(A_n \in da) \asymp e^{-\frac{n I''(a^*) (a - a^*)^2}{2}} da \quad (1.17)$$

which can be interpreted as a weak form of Central Limit Theorem. Another remarkable property is represented by the *contraction principle* which can be used to calculate a rate function from the knowledge of another rate function. Let A_n be a random variable satisfying the large deviation principle with rate function $I_A(a)$ and we are interested in computing the rate function of another random variable $B_n = -h(A_n)$, where h is a continuous function, named, in this particular case, *contraction* of A_n . Since

$$P(B_n \in db) = \int_{a:h(a)=b} P(A_n \in da) \quad (1.18)$$

we get

$$P(B_n \in db) \asymp \exp\left(-n \inf_{a:h(a)=b} I_a(a)\right) da \quad (1.19)$$

showing that, if the large deviation limit holds for A_n , it holds as well for B_n .

Therefore we may write:

$$P(B_n \in db) \asymp e^{-n I_B(b)} db \quad (1.20)$$

with a *rate function* given by

$$I_b = \inf_{a:h(a)=b} I_A(a). \quad (1.21)$$

In the large deviation theory the study of the equilibrium states can be reduced to the study of the rate functions, in particular it is possible to derive variational principles from the contraction principle. In equilibrium statistical mechanics, according to the large deviations of the mean energy, the *rate function* corresponds to the entropy function (up to an additive constant), and the scaled cumulant generating function correspond to the canonical free energy (up to a constant).

In non-equilibrium physical system, there is no general principle to allow us to compute the probability distribution from the knowledge of the system invariants. It is necessary to define the system precisely in order to compute the distribution and derive large deviation principles for observables as functions of the system's states, in order to characterize the most probable states as the minima of a rate function, generalizing the maximum entropy or minimum free energy principles. In non-equilibrium statistical mechanics, for a given stochastic process $X(t)$ we are interested to investigate whether the random variable A_τ defined as

$$A_\tau[x] = \frac{1}{\tau} \int_0^\tau f(x(t)) dt \quad (1.22)$$

named *time-average* of $f(x(t))$ over the time interval $[0, \tau]$ following a corresponding trajectory on the phase space, satisfies or not the large deviation principle. Through the **Gärtner-Ellis Theorem**, a large deviation principle can be derived for A_τ so that we may write :

$$P(A_\tau \in da) \asymp e^{-\tau I(a)} \quad I(a) = \sup_k [k \cdot a - \lambda(k)] \quad (1.23)$$

1.3.1 Fluctuation Relations as response from large deviations

In 1993, the paper [8] addressed the question of the fluctuations of the entropy production rate, in a pioneering attempt towards a unified theory of a wide range of nonequilibrium phenomena. In particular, a *Fluctuation Relation* (FR) was there derived and tested. It constitutes one of the few general exact results, obtained on purely dynamical grounds, for systems almost arbitrarily far from equilibrium, and close to equilibrium it is consistent with the Green-Kubo and Onsager relations. This FR reads:

$$\frac{\text{Prob}_\tau(\sigma \approx A)}{\text{Prob}_\tau(\sigma \approx -A)} = e^{\tau A} \quad (1.24)$$

where A and $-A$ are averages of the normalized power dissipated in a driven system, denoted by σ , in a long time τ , and $\text{Prob}_\tau(\pm A)$ is the steady state probability of observing values close to $\pm A$.

Remark: *Because this relation holds asymptotically in the observation time τ , it constitutes a large deviation result: for large τ , any $A \neq \langle \sigma \rangle$ lies many standard deviations away from its mean and corresponds to a large (macroscopic) deviation from the macroscopically observable value, namely $\langle \sigma \rangle$. The standard deviation, indeed, typically shrinks as $O(\tau^{-1/2})$ with τ .*

The FR (1.24) was derived for the following *isoenergetic* model of a 2-dimensional

shearing fluid:

$$\left\{ \begin{array}{l} \frac{d}{dt} \mathbf{q}_i = \frac{\mathbf{p}_i}{m} + \gamma y_i \hat{\mathbf{x}} \\ \frac{d}{dt} \mathbf{p}_i = \mathbf{F}_i(\mathbf{q}) + \gamma p_i^{(y)} \hat{\mathbf{x}} - \alpha_{th} \mathbf{p}_i \end{array} \right. \quad (1.25)$$

where γ is the shear rate in the y direction, $\hat{\mathbf{x}}$ is the unit vector in the x -direction, and the friction term α_{th} , called “thermostat”, takes the form

$$\alpha_{th}(\Gamma) = -\frac{\gamma}{\sum_{i=1}^N \mathbf{p}_i^2} \sum_{i=1}^N p_i^{(x)} p_i^{(y)} \quad (1.26)$$

as prescribed by Gauss’ principle of least constraint, in order to keep the internal energy fixed.

This molecular dynamics model was chosen by the authors of [8] because its phase space expansion rate Λ is proportional to α_{th} , hence a dynamical quantity, which can be expressed in terms of the probability distribution in phase space, could be related to the irreversible entropy production, or the energy dissipation rate, divided by $\sum \mathbf{p}_i^2$. The FR is parameter-free and, being dynamical in nature, it applies almost arbitrarily far from equilibrium as well as to small systems. All that made Ref. [8] a milestone of contemporary nonequilibrium statistical mechanics.

Gallavotti and Cohen provided the mathematical setting for the result of Ref. [8], introducing the Chaotic Hypothesis [24, 21, 23] which states:

Chaotic Hypothesis: *A reversible many-particle system in a stationary state can be regarded as a transitive Anosov system for the purpose of computing its macroscopic properties.*

Anosov systems can indeed be proven to have probability distributions of the kind assumed in [8]. The result is a steady state FR for the fluctuations of Λ , which we call

Λ -FR and will be described below. As the Anosov property practically means a high degree of randomness, analogous results have been obtained first for given properties of finite state space Markov chains and later for many stochastic processes (Kurchan, Lebowitz-Spohn, Maes). Stochastic processes are easier to handle, but ambiguities affect observables, except special cases. We do not attempt an exhaustive review of this subject; there exist numerous review papers, such as Refs. [31, 44, 37]. We focus instead on some specific results for deterministic dynamics.

1.3.2 The Gallavotti-Cohen approach

The idea proposed by Gallavotti and Cohen [25] is that dissipative, reversible, transitive Anosov maps, $S : \mathcal{M} \rightarrow \mathcal{M}$, are idealizations of nonequilibrium particle systems. That the system evolves with discrete or continuous time, was thought to be a side issue in Ref. [25]. The validity of the Λ -FR for Anosov maps is based on the fact that these systems admit a *Markov* partitions of the phase space [41], i.e. a subdivision of \mathcal{M} into cells whose interiors are disjoint from each other, and whose boundaries are invariant sets, which in two dimensions are constructed using stable and unstable manifolds. Furthermore, arbitrarily fine partitions can be constructed, exploiting the time-reversibility of the dynamics. Gallavotti and Cohen further assume that the dynamics is transitive, i.e. that a typical trajectory explores all regions of \mathcal{M} , as finely as one wishes. This structure allows the probability (Lyapunov) weights of Eq.(1) in Ref. [8], from which the Λ -FR follows to represent the probability of the cells of a Markov partition.

More precisely, let $\Lambda(X) = \log J(X)$, where J is the Jacobian determinant of

S^1 , and consider the steady state probability of the dimensionless phase space contraction rate e_τ , obtained along a trajectory segment $w_{X,\tau}$, of origin $X \in \mathcal{M}$ and duration τ :

$$e_\tau(X) = \frac{1}{\tau \langle \Lambda \rangle} \sum_{k=-\tau/2}^{\tau/2-1} \Lambda(S^k X) \quad (1.27)$$

where $\langle \cdot \rangle$ is the steady state phase space average and $S^k X$ denotes the evolution that S generates from the initial condition $X(0) = X$. Let J^u be the Jacobian determinant of S restricted to the unstable manifold V^+ , i.e. the product of the asymptotic factors of separation of nearby points, along the directions in which distances asymptotically grow at an exponential rate. *If the system is Anosov*, the probability of the event $e_\tau(X) \in B_{p,\epsilon} \equiv (p - \epsilon, p + \epsilon)$ coincides, in the limit of fine Markov partitions and long τ 's, with the sum of the weights

$$w_{X,\tau} = \prod_{k=-\tau/2}^{\tau/2-1} \frac{1}{J^u(S^k X)} \quad (1.28)$$

of the cells containing the points X such that $e_\tau(X) \in B_{p,\epsilon}$. Then, if $\pi_\tau(B_{p,\epsilon})$ is the corresponding probability, one can write

$$\pi_\tau(e_\tau(X) \in B_{p,\epsilon}) \approx \frac{1}{M} \sum_{X, e_\tau(X) \in B_{p,\epsilon}} w_{X,\tau} \quad (1.29)$$

where M is a normalization constant. *If the support of the physical measure is \mathcal{M}* , which is the case if the dissipation is not exceedingly high [9], time-reversibility guarantees that the support of π_τ includes an interval $[-p^*, p^*]$, $p^* > 0$, and one can consider the ratio

$$\frac{\pi_\tau(B_{p,\epsilon})}{\pi_\tau(B_{-p,\epsilon})} \approx \frac{\sum_{X, e_\tau(X) \in B_{p,\epsilon}} w_{X,\tau}}{\sum_{X, e_\tau(X) \in B_{-p,\epsilon}} w_{X,\tau}}, \quad (1.30)$$

¹If the point X has d coordinates, X_i , $i = 1, \dots, d$, we can write $X_i(k+1) = f_i(X(k))$, where f_i is a suitable function determined by S . Then $J(X)$ is the absolute value of the determinant of the matrix $(\partial f_i / \partial X_j)_X$.

where each X in the numerator has a counterpart in the denominator. Denoting by I the involution which replaces the initial condition of one trajectory with the initial condition of the reversed trajectory, time-reversibility yields:

$$\Lambda(X) = -\Lambda(IX) , \quad w_{IX,\tau} = w_{X,\tau}^{-1} \quad \text{and} \quad \frac{w_{X,\tau}}{w_{IX,\tau}} = e^{-\tau\langle\Lambda\rangle p} \quad (1.31)$$

if $e_\tau(X) = p$. Taking small ϵ in $B_{p,\epsilon}$, the division of each term in the numerator of (1.30) by its counterpart in the denominator approximately equals $e^{-\tau\langle\Lambda\rangle p}$, which then equals the ratio in (1.30). In the limit of small ϵ , infinitely fine Markov partition and large τ , the authors of [25] obtain the following theorem:

Gallavotti-Cohen Theorem. *Let (\mathcal{M}, S) be dissipative (i.e. $\langle\Lambda\rangle < 0$), reversible and assume that the chaotic hypothesis holds. Then, in the $\tau \rightarrow \infty$ limit, one has*

$$\frac{\pi_\tau(B_{p,\epsilon})}{\pi_\tau(B_{-p,\epsilon})} = e^{-\tau\langle\Lambda\rangle p} . \quad (1.32)$$

with an error in the argument of the exponential which can be estimated to be p - and τ -independent.

If the Λ -FR (hence the chaotic hypothesis on which it is based) holds, the function $C(p; \tau, \epsilon) = (1/\tau\langle-\Lambda\rangle) \log [\pi_\tau(B_{p,\epsilon})/\pi_\tau(B_{-p,\epsilon})]$, tends to a straight line of slope 1 for growing τ , apart from small errors. If Λ can be identified with a physical observable, the Λ -FR is a parameter-free statement about the physics of nonequilibrium systems. Unfortunately, Λ differs from the dissipated power in general, [15], hence alternative approaches have been developed.

1.4 The dissipation function

1.4.1 Evolution of probability distributions

This section recalls some basic notions of dynamical systems theory, thus introducing the notation which will be used later. Consider a dynamical system defined by an evolution equation on a phase space \mathcal{M} :

$$\dot{\Gamma} = F(\Gamma), \quad \Gamma \in \mathcal{M} \quad (1.33)$$

whose trajectories for each initial condition Γ are given by $\{S^t\Gamma\}_{t \in \mathbb{R}}$, where S^t is the operator that moves Γ to its position after a time t , hence $S^0\Gamma = \Gamma$. We will consider time reversal invariant dynamics, i.e. the dynamics for which

$$IS^t\Gamma = S^{-t}I\Gamma, \quad \forall \Gamma \in \mathcal{M} \quad (1.34)$$

holds, where the linear operator $I : \mathcal{M} \rightarrow \mathcal{M}$ is an involution ($I^2 = \text{identity}$) representing a time reversal operation. For instance, in the Hamiltonian dynamics, where $\Gamma = (\mathbf{q}, \mathbf{p})$, one may take $I(\mathbf{q}, \mathbf{p}) = (\mathbf{q}, -\mathbf{p})$. Furthermore, we will consider evolutions such that $\{S^t\}_{t=-\infty}^{\infty}$ satisfies the group property $S^t S^s = S^{t+s}$. The time averages of a phase variable $\phi : \mathcal{M} \rightarrow \mathbb{R}$, along a trajectory starting at Γ , are denoted by:

$$\bar{\phi}(\Gamma) = \lim_{t \rightarrow \infty} \frac{1}{t} \int_0^t \phi(S^s\Gamma) ds \quad (1.35)$$

If the dynamics represent a thermodynamic system, in which Γ is a single microscopic state, the time average should not depend on Γ ,² and could be obtained as a phase

²Except a negligible set of phase space points.

space average, with respect to a given probability distribution μ :

$$\bar{\phi}(\Gamma) = \int_{\mathcal{M}} \phi(X) \, d\mu(X) = \langle \phi \rangle_{\mu}, \quad \text{for almost every } \Gamma \in \mathcal{M} \quad (1.36)$$

This is the case when the dynamical system (S, \mathcal{M}, μ) is ergodic. Ergodicity is a very strong property, which is not strictly obeyed by most of the systems of physical interest. It can be however assumed to hold very often, because physics is usually concerned with a small set of observables and for systems made of exceedingly large numbers of particles, c.f. [28].

Once \mathcal{M} is endowed with a probability distribution μ_0 , $\mu_0(\mathcal{M}) = 1$ and $\mu_0(E) \geq 0$ for all allowed events $E \subset \mathcal{M}$, the dynamics in \mathcal{M} may be used to induce an evolution in the space of probabilities. One may assume that the subsets of the phase space have a certain probability, which they carry along where the dynamics moves them. As a consequence, the probability distribution on \mathcal{M} changes in time, and one may introduce a set of distributions $\{\mu_t\}_{t \in \mathbb{R}}$ as follows:

$$\mu_t(E) = \int_E d\mu_t = \int_{S^{-t}E} d\mu_0 = \mu_0(S^{-t}E) \quad (1.37)$$

where $S^{-t}E$ is the preimage of E a time t earlier. This relation simply means that the probability of $S^{-t}E$ at the initial time, belongs to E at time t . With this definition, probability is conserved in phase space and flows like a compressible fluid, in general.³ Taking much care, the evolution of the probability distributions may be used to define an evolution of the observables, introducing

$$\langle \phi \rangle_t = \int_{\mathcal{M}} \phi \, d\mu_t \quad (1.38)$$

³In the case of Hamiltonian dynamics, and more generally in the case of the so-called *adiabatically incompressible* systems, probabilities flow like incompressible fluids.

As the mean values of the phase functions completely characterize the system, one often refers to μ_t as to the *state* of the system at time t . A probability measure μ is called *invariant* if $\mu(E) = \mu(S^{-t}E)$ for all t and all measurable sets E .

Sometimes probability measures μ_t have corresponding densities f_t , i.e. one can write $d\mu_t(\Gamma) = f_t(\Gamma)d\Gamma$. In that case, one may follow the evolution of μ_t by following the evolution of the integrable, non-negative function f_t , as determined by the definition (1.37). Operating the change of coordinates $Y = S^tX$, i.e. $X = S^{-t}Y$, in the last integral of the following expression

$$\mu_t(E) = \int_E f_t(X) dX = \int_{S^{-t}E} f_0(X) dX \quad (1.39)$$

one obtains:

$$\int_E f_t(X) dX = \int_E f_0(Y)J^{-t}(Y) dY \quad (1.40)$$

where $J^{-t}(Y) = |(\partial S^{-t}X/\partial X)|_Y$ is the Jacobian of the transformation. As it holds for all allowed subsets of \mathcal{M} , one can write

$$f_t(X) = f_0(S^{-t}X)J^{-t}(X) \quad (1.41)$$

For Hamiltonian dynamics, $J^{-t}(X) = 1$, hence $f_t(X) = f_0(S^{-t}X)$.

In general, the evolution of the observables is given by:

$$\langle \phi \rangle_t = \int_{\mathcal{M}} \phi(\Gamma)f_t(\Gamma)d\Gamma = \int_{\mathcal{M}} \phi(\Gamma)f_0(S^{-t}\Gamma)J^{-t}(\Gamma)d\Gamma \quad (1.42)$$

Introducing $Y = S^t\Gamma$ in the last integral, so that $d\Gamma = J^t(Y)dY$, one finds:

$$\langle \phi \rangle_t = \int_{\mathcal{M}} \phi(S^tY)f_0(Y)J^{-t}(S^tY)J^t(Y)dY \quad (1.43)$$

To make this expression more explicit, we need to say more about the evolution of probability densities. Because probability is transported by the phase space points

like mass is transported in a fluid, the evolution equation for a probability density f in the phase space is given by a formal continuity equation, as follows:

$$\frac{\partial f}{\partial t} = -\nabla_{\Gamma} \cdot (Ff) , \quad \frac{df}{dt} = \frac{\partial f}{\partial t} + \nabla_{\Gamma} f \cdot F = -f \nabla_{\Gamma} \cdot F = -f \Lambda \quad (1.44)$$

where $\nabla_{\Gamma} \cdot F$ is the divergence of the vector field F on \mathcal{M} , as implied by Eq.(1.33), and:

$$\frac{d}{dt} = \frac{\partial}{\partial t} + F \cdot \nabla_{\Gamma} , \quad \Lambda = \nabla_{\Gamma} \cdot F = -\frac{d}{dt} \ln f \quad (1.45)$$

respectively are the total time derivative, according to the definition of F (Eq.(1.33)), and Λ is the phase space expansion rate. Equations (1.44) are generalizations of the Liouville equation, since they apply in general and not only to the Hamiltonian dynamics. We refer to them as to the Liouville equations as well for brevity.

Eq.(1.41) may be rewritten explicitly:

$$f_t(X) = f_0(S^{-t}X) e^{\int_{-t}^0 \Lambda(S^s X) ds} \quad (1.46)$$

and Eq.(1.43) takes the useful form

$$\langle \phi \rangle_t = \int_{\mathcal{M}} (\phi \circ S^t)(X) f_0(X) J^{-t}(S^t X) J^t(X) dX = \langle \phi \circ S^t \rangle_0 \quad (1.47)$$

1.4.2 Fluctuation relations for the dissipation function

Evans and Searles obtained the first of a series of relations which appeared deceptfully similar to Eq.(1.24), for the *Dissipation Function* Ω , which, in nonequilibrium states close to equilibrium can be identified with the *entropy production rate*, $\sigma = JV F^{ext}/k_B T$. Here, J is the (intensive) flux due to the thermodynamic force F^{ext} , V is the volume and T the kinetic temperature [11, 12]. That relation, called transient Ω -FR, is obtained under virtually no hypothesis, except for *time*

reversibility; it is transient because it concerns non-invariant ensembles of systems, instead of the steady state. This approach is based on the belief that the complete knowledge of the invariant measure implied by the Chaotic Hypothesis is not needed to understand a few properties of the steady state, like thermodynamic relations do not depend on the details of the microscopic dynamics [16].

Let \mathcal{M} be the phase space of the system at hand, and $S^\tau : \mathcal{M} \rightarrow \mathcal{M}$ a reversible evolution corresponding to $\dot{\Gamma} = F(\Gamma)$. Take a probability measure $d\mu_0(\Gamma) = f_0(\Gamma)d\Gamma$ on \mathcal{M} , and let the observable $\mathcal{O} : \mathcal{M} \rightarrow \mathbb{R}$ be odd with respect to time reversal *i.e.*, $\mathcal{O}(I\Gamma) = -\mathcal{O}(\Gamma)$. Denote its time averages by

$$\overline{\mathcal{O}}_{t,t+\tau}(\Gamma) \equiv \frac{1}{\tau} \mathcal{O}_{t_0,t_0+\tau}(\Gamma) \equiv \frac{1}{\tau} \int_{t_0}^{t_0+\tau} \mathcal{O}(S^s\Gamma) ds . \quad (1.48)$$

For a density f_0 even with respect to time reversal [$f_0(I\Gamma) = f_0(\Gamma)$], define the

Dissipation function:

$$\Omega(\Gamma) = - \left. \frac{d}{d\Gamma} \log f_0 \right|_{\Gamma} \cdot \dot{\Gamma} - \Lambda(\Gamma) , \quad \text{so that} \quad (1.49)$$

$$\overline{\Omega}_{t,t+\tau}(\Gamma) = \frac{1}{\tau} \left[\ln \frac{f_0(S^t\Gamma)}{f_0(S^{t+\tau}\Gamma)} - \Lambda_{t,t+\tau} \right] \quad (1.50)$$

For a compact phase space, the uniform density $f_0(\Gamma) = 1/|\mathcal{M}|$ implies $\Omega = \Lambda$, which was the case of the original FR. The existence of the logarithmic term in (1.49) is called *ergodic consistency*, a condition met if $f_0 > 0$ in all regions visited by all trajectories $S^t\Gamma$.

For $\delta > 0$, let $A_\delta^+ = (A - \delta, A + \delta)$ and $A_\delta^- = (-A - \delta, -A + \delta)$, and let $E(\mathcal{O} \in (a, b))$ be the set of points Γ such that $\mathcal{O}(\Gamma) \in (a, b)$. Then, $E(\overline{\Omega}_{0,\tau} \in A_\delta^-) = IS^\tau E(\overline{\Omega}_{0,\tau} \in A_\delta^+)$, and the transformation $\Gamma = IS^\tau X$ has Jacobian

$$\left| \frac{d\Gamma}{dX} \right| = \exp \left(- \int_0^\tau \Lambda(S^s X) ds \right) = e^{-\Lambda_{0,\tau}(X)} , \quad (1.51)$$

Introduce $\langle \mathcal{O} \rangle_{\bar{\Omega}_{0,\tau} \in A_\delta^+}$ as the average of \mathcal{O} computed with respect to μ_0 , under the condition that $\bar{\Omega}_{0,\tau} \in A_\delta^+$. Then, one may write

$$\begin{aligned} \frac{\mu_0(E(\bar{\Omega}_{0,\tau} \in A_\delta^+))}{\mu_0(E(\bar{\Omega}_{0,\tau} \in A_\delta^-))} &= \frac{\int_{E(\bar{\Omega}_{0,\tau} \in A_\delta^+)} f(\Gamma) d\Gamma}{\int_{E(\bar{\Omega}_{0,\tau} \in A_\delta^+)} f(S^\tau X) e^{-\Lambda_{0,\tau}(X)} dX} \\ &= \frac{\int_{E(\bar{\Omega}_{0,\tau} \in A_\delta^+)} f(\Gamma) d\Gamma}{\int_{E(\bar{\Omega}_{0,\tau} \in A_\delta^+)} e^{-\Omega_{0,\tau}(X)} f_0(X) dX} = \langle e^{-\Omega_{0,\tau}} \rangle_{\bar{\Omega}_{0,\tau} \in A_\delta^+}^{-1} \end{aligned} \quad (1.52)$$

i.e.,

$$\frac{\mu(E(\bar{\Omega}_{0,\tau} \in A_\delta^+))}{\mu(E(\bar{\Omega}_{0,\tau} \in A_\delta^-))} = e^{[A+\epsilon(\delta,A,\tau)]\tau}, \quad (1.53)$$

with ϵ an error term due to the finiteness of δ , such that $|\epsilon(\delta, A, \tau)| \leq \delta$. We call [1.53](#) the *transient* Ω -FR. The transient Ω -FR refers to the non-invariant probability measure μ of density f ; it is remarkable that time reversibility is the only ingredient of its derivation. To obtain the steady state Ω -FR, let averaging begin at time t_0 and consider

$$\frac{\mu(E(\bar{\mathcal{O}}_{t,t+\tau} \in A_\delta^+))}{\mu(E(\bar{\mathcal{O}}_{t,t+\tau} \in A_\delta^-))}. \quad (1.54)$$

Taking $t = \tau + 2t_0$, the transformation $\Gamma = iS^\tau W$ and some algebra yield

$$\frac{\mu(E(\bar{\mathcal{O}}_{t,t+\tau} \in A_\delta^+))}{\mu(E(\bar{\mathcal{O}}_{t,t+\tau} \in A_\delta^-))} = \langle \exp(-\Omega_{0,t}) \rangle_{\bar{\mathcal{O}}_{t_0,t_0+\tau} \in A_\delta^+}^{-1}, \quad (1.55)$$

and for $\bar{\mathcal{O}}_{t,t+\tau} = \bar{\Omega}_{t,t+\tau}$

$$\frac{\mu(E(\bar{\Omega}_{t,t+\tau} \in A_\delta^+))}{\mu(E(\bar{\Omega}_{t,t+\tau} \in A_\delta^-))} = e^{[A+\epsilon(\delta,t_0,A,\tau)]\tau} \langle e^{-\Omega_{0,t_0} - \Omega_{t_0+\tau,2t_0+\tau}} \rangle_{\bar{\Omega}_{t,t+\tau} \in A_\delta^+}^{-1}, \quad (1.56)$$

where $|\epsilon(\delta, t_0, A, \tau)| \leq \delta$ is due to the finiteness of A_δ^+ .

Having fixed $\tau > 0$ and the tolerance $\delta > 0$, we say that A lies in the domain \mathcal{D} of the steady state Ω -FR, if there exists $\hat{t} > 0$ such that $\mu(E(\bar{\Omega}_{t,t+\tau} \in A_\delta^+)) > 0$ and $\mu(E(\bar{\Omega}_{t,t+\tau} \in A_\delta^-)) > 0$ for all $t_0 \geq \hat{t}$. In other words, $A \in \mathcal{D}$ if positive and negative fluctuations of size A have positive probability in the steady state. Using

$\mu(E) = \mu_{t_0}(S^{t_0}E)$, where E is a subset of \mathcal{M} , and μ_{t_0} is the evolved measure up to time t_0 , with density f_{t_0} , some algebra yields the \mathcal{O} -FR:

$$\frac{\mu_{t_0}(E(\overline{\mathcal{O}}_{0,\tau} \in A_\delta^+))}{\mu_{t_0}(E(\overline{\mathcal{O}}_{0,\tau} \in A_\delta^-))} = \frac{\mu(E(\overline{\mathcal{O}}_{t,t+\tau} \in A_\delta^+))}{\mu(E(\overline{\mathcal{O}}_{t,t+\tau} \in A_\delta^-))} = \langle \exp(-\Omega_{0,t}) \rangle_{\overline{\mathcal{O}}_{t,t+\tau} \in A_\delta^+}^{-1}. \quad (1.57)$$

For $\overline{\mathcal{O}}_{t,t+\tau} = \overline{\Omega}_{t,t+\tau}$, taking the logarithm and dividing by τ produces:

$$\frac{1}{\tau} \ln \frac{\mu_{t_0}(E(\overline{\Omega}_{0,\tau} \in A_\delta^+))}{\mu_{t_0}(E(\overline{\Omega}_{0,\tau} \in A_\delta^-))} = A + \epsilon(\delta, t_0, A, \tau) - \frac{1}{\tau} \ln \langle e^{-\Omega_{0,t_0} - \Omega_{t_0+\tau, 2t_0+\tau}} \rangle_{\overline{\Omega}_{t,t+\tau} \in A_\delta^+} \quad (1.58)$$

If μ_{t_0} tends to a steady state μ_∞ when $t_0 \rightarrow \infty$, Eq.(1.58) should change from a statement on the ensemble f_{t_0} , to a statement on the statistics generated by a single typical trajectory. To be of practical use, however, this statement requires that the logarithm of the conditional average, divided by τ , $M(A, \delta, t_0, \tau)$ say, be controllable in Eq.(1.58). For instance, if it can be made negligible, e.g. letting δ be small and τ grow after the $t_0 \rightarrow \infty$ limit has been taken, as in the case of the Λ -FR, one would have the

Steady State Ω -FR. *For any tolerance $\gamma > 0$ and $A \in \mathcal{D}$, there are sufficiently small $\delta > 0$ and large τ , such that*

$$A - \gamma \leq \frac{1}{\tau} \ln \frac{\mu_\infty(E(\overline{\Omega}_{0,\tau} \in A_\delta^+))}{\mu_\infty(E(\overline{\Omega}_{0,\tau} \in A_\delta^-))} \leq A + \gamma \quad (1.59)$$

holds.

As in the case of the Λ -FR, the domain \mathcal{D} would be model dependent, and its expression could rest on non-trivial dynamical relations [21]. This requires some assumption. Indeed, the growth of t_0 could make $M(A, \delta, t_0, \tau)$ diverge (as in properly devised examples [16]). If $\lim_{t_0 \rightarrow \infty} |M(A, \delta, t_0, \tau)|$ is bounded by some finite $M(A, \delta, \tau)$, $\lim_{\tau \rightarrow \infty} M(A, \delta, \tau)$ could still exceed the value of γ . The first difficulty

is simply solved by the observation that the divergence of $M(A, \delta, t_0, \tau)$ implies a divergence of the left hand side of Eq.(1.58), which in turn means that one of its two probabilities vanish, i.e. that $A \notin \mathcal{D}$. If \mathcal{D} is empty, the steady state Ω -FR is of no interest, because there are no fluctuations in the steady state.

Therefore, let us assume that $A \in \mathcal{D}$, and observe that the conservation of probability yields the relation

$$\langle e^{-\Omega_{0,s}} \rangle = 1, \quad \text{for every } s \in \mathbb{R}, \quad (1.60)$$

first derived by Morriss and Evans (cf. [10], pp.198-202). Then, one possibility that can be considered is that the Ω -autocorrelation time vanishes. In that case, one can write:

$$1 = \langle e^{-\Omega_{0,s} - \Omega_{s,t}} \rangle = \langle e^{-\Omega_{0,s}} \rangle \langle e^{-\Omega_{s,t}} \rangle, \quad \langle e^{-\Omega_{s,t}} \rangle = 1, \quad \text{for all } s, t, \quad (1.61)$$

hence

$$\langle e^{-\Omega_{0,t_0}} \cdot e^{-\Omega_{t_0+\tau, 2t_0+\tau}} \rangle_{\overline{\Omega_{t,t+\tau} \in A_\delta^+}} = \langle e^{-\Omega_{0,t_0}} \cdot e^{-\Omega_{t_0+\tau, 2t_0+\tau}} \rangle = 1. \quad (1.62)$$

Then, the logarithmic correction term in (1.58) identically vanishes for all t_0, τ , and the Ω -FR is verified at all $\tau > 0$. Of course, this idealized situation does not need to be realized, but tests performed on molecular dynamics systems [14] indicate that the typical situation is not dissimilar from this; typically, there exists a constant K , such that

$$0 < \frac{1}{K} \leq \langle e^{-\Omega_{0,t_0} - \Omega_{t_0+\tau, 2t_0+\tau}} \rangle_{\overline{\Omega_{t,t+\tau} \in A_\delta^+}} \leq K. \quad (1.63)$$

As a matter of fact, the de-correlation or Maxwell time, t_M , expresses a physical property of the system, thus it does not depend on t_0 or τ , and depends only mildly on the external field [usually, $t_M(F_e) = t_M(0) + O(F_e^2)$]. Its order of magnitude is that

of the mean free time. If $\tau \gg t_M$, the boundary terms $\Omega_{t_0-t_M, t_0}$ and $\Omega_{t_0+\tau, t_0+\tau+t_M}$ are typically small compared to $\Omega_{t_0, t_0+\tau}$, unless some singularity of Ω occurs within $(t_0 - t_M, t_0)$ or $(t_0 + \tau, t_0 + \tau + t_M)$. However, similar events may equally occur in the intervals $(0, t_0)$ and $(t_0 + \tau, 2t_0 + \tau)$, hence $\Omega_{t_0-t_M, t_0}$ and $\Omega_{t_0+\tau, t_0+\tau+t_M}$ are expected to contribute only a fraction of order $O(t_M/\tau)$ to the arguments of the exponentials in the conditional average. Therefore, one can write

$$\begin{aligned}
\langle e^{-\Omega_{0, t_0}} \cdot e^{-\Omega_{t_0+\tau, 2t_0+\tau}} \rangle_{\bar{\Omega}_{t_0, t_0+\tau} \in A_\delta^+} &\approx \langle e^{-\Omega_{0, t_0-t_M}} \cdot e^{-\Omega_{t_0+\tau+t_M, 2t_0+\tau}} \rangle_{\bar{\Omega}_{t_0, t_0+\tau} \in A_\delta^+} \\
&\approx \langle e^{-\Omega_{0, t_0-t_M}} \cdot e^{-\Omega_{t_0+\tau+t_M, 2t_0+\tau}} \rangle \\
&\approx \langle e^{-\Omega_{0, t_0+t_M}} \rangle \langle e^{-\Omega_{t_0+\tau+t_M, 2t_0+\tau}} \rangle = O(1), \quad (1.64)
\end{aligned}$$

with an accuracy which improves with growing t_0 and τ , because t_M is fixed. If these scenarios are realized, Eq.(1.63) follows and $M(A, \delta, t_0, \tau)$ vanishes as $1/\tau$, with a characteristic scale of order $O(t_M)$. In summary, the steady state Ω -FR holds under the following conditions.

Conditions:

1. *the dynamics is time reversal invariant.*
2. *μ_t tends to μ_∞ for $t \rightarrow \infty$.*
3. *Eq.(1.63) is satisfied with $K > 0$, for $A \in \mathcal{D}$, if τ and t_0 are sufficiently larger than t_M .*

Condition (1.63) can actually be weakened, but the decay of the Ω -autocorrelations characterizes the convergence to a steady state, and is very widely verified. Therefore, the validity of Eq.(1.63), and not a weaker condition, explains why the steady state Ω -FR holds for the particle systems so far investigated. The above derivation

of the steady state Ω -FR, under Conditions 1, 2 and 3, will not only answer the physics questions, but will also be mathematically rigorous, if it will be proven that one (possibly physically uninteresting) dynamical system satisfies them.

Various other relations can now be obtained [16]. For instance, any odd \mathcal{O} , any $\delta > 0$, any t_0 and any τ yield

$$\langle \exp(-\Omega_{0,t}) \rangle_{\overline{\mathcal{O}}_{t,t+\tau} \in (-\delta, \delta)} = \frac{\mu_{t_0}(E(\overline{\mathcal{O}}_{0,\tau} \in (-\delta, \delta)))}{\mu_{t_0}(E(\overline{\mathcal{O}}_{0,\tau} \in (-\delta, \delta)))} = 1, \quad (1.65)$$

which, in the $\delta \rightarrow \infty$ limit, produces the normalization property (1.60). The Dissipation relation

$$\langle \mathcal{O}(t) \rangle = \int_0^t ds \langle \Omega(0) \mathcal{O}(s) \rangle, \quad (1.66)$$

is another direct consequence of the approach followed in this section [13].

1.4.3 Green-Kubo relations

A consistency check of the present theory is afforded by the derivation of the Green-Kubo relations based on the Ω -FR [15]. Differently from Ref.[22], which deals with time-asymptotic quantities, this derivation stresses the role of the physical time scales. To be concrete, take a Nosé-Hoover thermostatted system, whose equilibrium state is the extended canonical density

$$f_c(x, \alpha) = \frac{e^{-\beta(H_0 + Q\alpha^2/2)}}{\int d\alpha dx e^{-\beta(H_0 + Q\alpha^2/2)}}, \quad (1.67)$$

where $Q = 2K_0\tau^2$ and H_0 is the internal energy [10]. This yields

$$f_c(\alpha) = \int dx f_c(x, \alpha) = \sqrt{\frac{\beta Q}{2\pi}} \exp[-\beta Q \alpha^2 / 2] \quad (1.68)$$

Therefore, the distribution of $\alpha_{0,t}$ is Gaussian in equilibrium, and near equilibrium it can be assumed to remain such, around its mean, for large t (CLT). To use the FR

together with the CLT, the values A and $-A$ must be a small number of standard deviations away from $\langle \Omega \rangle$. In [39] it was proven that

$$t\sigma_{J_t}(F_e) = 2L(F_e)k_B T/V + O((F_e)^2/tN) ,$$

where

$$L(F_e) = \beta V \int_0^\infty dt \langle (J(t) - \langle J \rangle_{F_e})(J(0) - \langle J \rangle_{F_e}) \rangle_{F_e} ,$$

F_e is the external field, $\langle \cdot \rangle_{F_e}$ is the phase space average at field F_e and $L(0) = \lim_{F_e \rightarrow 0} L(F_e)$ is the corresponding linear transport coefficient. When t grows, $A = 0$ gets more and more standard deviations away from $\langle \Omega \rangle$, which is $O(F_e^2)$, for small F_e , while the standard deviation tends to a positive constant, since that of α tends to $1/\sqrt{\beta Q}$. Assume for simplicity that the variance of $\Omega_{0,t}(F_e)$ is monotonic in F_e at fixed t , and in t at fixed F_e . Then, there is $t_\sigma(F_e, A)$ such that the variance is sufficiently large when $t < t_\sigma(F_e, A)$. At the same time, t has to be larger than a given $t_\delta(F_e, A)$ for the steady state Ω -FR to apply to the values A and $-A$, with accuracy δ . Assume that also $t_\delta(F_e, A)$ is monotonic in F_e . To derive the Green-Kubo relations, one then needs $t_\delta(F_e, A) < t < t_\sigma(F_e, A)$ for $F_e \rightarrow 0$, which is possible because the distribution tends to a Gaussian centered in zero, when F_e tends to zero and t is fixed. The result is:

$$\langle \Omega \rangle = \frac{t}{2} \sigma^2(\Omega) \quad \text{or} \quad L(0) = \lim_{F_e \rightarrow 0} \frac{\langle J \rangle_{F_e}}{F_e} = \beta V \int_0^\infty dt \langle J(0)J(t) \rangle_{F_e=0} . \quad (1.69)$$

Chapter 2

Discrete Dynamical Systems: the multibaker map

The theory of Fluctuation Relations (FR), originated with the seminal works of Evans [11, 12] and Gallavotti-Cohen [24], became increasingly popular in statistical mechanics, as it allows to discuss the statistical properties of a system even far from equilibrium. Much of the mathematical effort has been devoted in shedding light on the mathematical conditions which must be invoked to derive such relations, in the deterministic as well as in the stochastic setting. While some recent works clarified the role of the smoothness of the invariant probability measure along the unstable direction and of the time-reversibility [35, 33] needed to derive the Λ -FR, recent trends also pointed towards the identification of the minimal mathematical structures essential for the Transient FR to hold.

We investigate a 2D reversible dynamical system known as the multibaker map. Our results can be summarized as follows:

- We introduce a novel, weaker, notion of time reversibility, which still allows to identify pairs of conjugated trajectories in the phase space, giving rise to opposite values of phase space contraction over a segment of n time steps.
- The role of ergodicity at equilibrium is shown to be essential for the validity of the Transient FR.
- although in absence of the sufficient mathematical hypothesis, we numerically verify a peculiar convergence to a FR holding just in the asymptotic long-time limit. As the FRs extends its pertinence amply in dissipative systems, this supports the idea that FRs, in principle, may extend their validity well above their current strict mathematical requirements.

2.1 The multibaker map

Here we consider multibaker maps, which are analytically tractable models allowing to explore the fluctuation theorems, although their physical limitations [19, 30]. We introduce a slightly generalized baker's transformations which has been discussed in reference [33, 35].

Let (\mathcal{U}, M_0, μ) be a dynamical system with phase space $\mathcal{U} := \mathbb{T}^2 := \mathbb{R}^2/\mathbb{Z}^2$ and mapping $M_0 : \mathcal{U} \rightarrow \mathcal{U}$ defined by:

$$\begin{aligned}
\begin{pmatrix} x_{n+1} \\ y_{n+1} \end{pmatrix} = M_0 \cdot \begin{pmatrix} x_n \\ y_n \end{pmatrix} = \begin{cases} \begin{pmatrix} \frac{1}{2\ell}x_n + \frac{1}{2} \\ \frac{1}{2}y_n + \frac{1}{2} \end{pmatrix} & \text{for } 0 \leq x \leq \ell \\ \begin{pmatrix} \frac{x_n}{1-2\ell} - \frac{\ell}{1-2\ell} \\ (1-2\ell)y_n + 2\ell \end{pmatrix} & \text{for } \ell \leq x \leq \frac{1}{2} \\ \begin{pmatrix} 2x_n - \frac{1}{2} \\ \frac{1}{2}y_n \end{pmatrix} & \text{for } \frac{1}{2} \leq x \leq \frac{3}{4} \\ \begin{pmatrix} 2x_n - \frac{3}{2} \\ 2\ell y_n \end{pmatrix} & \text{for } \frac{3}{4} \leq x \leq 1 \end{cases} \quad (2.1)
\end{aligned}$$

with natural measure μ . The subscript 0 in M_0 emphasizes that this map corresponds to the "equilibrium" version (i.e. obtained by setting $q = 0$) of a former more general model introduced in Ref.[33, 35]. Next, let us introduce a unitary transformation in phase space, i.e. a *rotation* which preserves phase space volumes and is defined by the map R :

$$\begin{pmatrix} x' \\ y' \end{pmatrix} = R \cdot \begin{pmatrix} x \\ y \end{pmatrix} = \begin{pmatrix} 1-y \\ x \end{pmatrix} \quad (2.2)$$

Thus, we consider the composite map $L = RM_0$ shown in Fig 2.1.

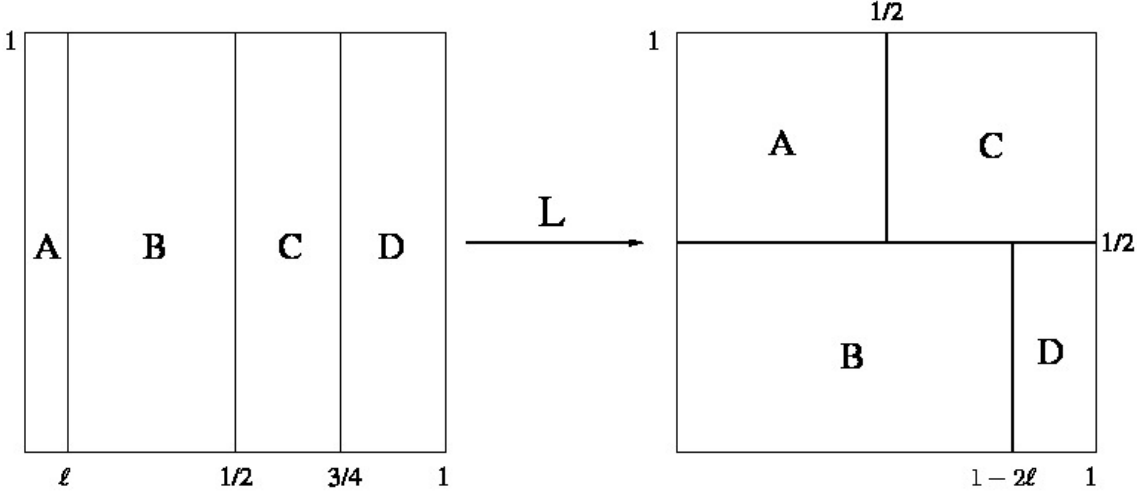

Figure 2.1: Map L defined as the composition of the maps in (2.1) and (2.2).

2.2 Time reversibility

Let us now consider the question of the reversibility for $L = RM_0$. The map M_0 , as already discussed in [33, 35], is equipped with an involution $G = G^{-1}$ such that:

$$M_0GM_0 = G \quad (2.3)$$

Eq. (2.3) expresses the standard notion of time-reversibility for a dynamical system.

It proves also convenient to introduce the inverse rotation R^{-1} , such that $R^{-1}R = I$ (with I the Identity Operator). Thus, by acting on Eq. (2.3), from the left with the map R , we obtain:

$$RM_0G(R^{-1}R)M_0 = RG \quad (2.4)$$

By defining $\tilde{G} = GR^{-1}$, and by also noticing that

$$RG = (R^{-1})^{-1}G^{-1} = (GR^{-1})^{-1} = \tilde{G}^{-1} \quad (2.5)$$

holds for the right hand side of (2.4). it follows that Eq. (2.4) attains the compact form:

$$L\tilde{G}L = \tilde{G}^{-1} \quad (2.6)$$

Eq. (2.6) is not written in the standard form for reversible dynamics (since its right hand side has the term \tilde{G}^{-1} , rather than \tilde{G}^{-1}), nevertheless this poses no problem if one wants to take trajectories in pairs characterized by certain properties [45], as will become clear below. Moreover, Eq. (2.6) can be rewritten as:

$$L\tilde{G}L\tilde{G} = I \quad ; \quad L\tilde{G}L\tilde{G}x = x \quad (2.7)$$

Then, from (2.7), by differentiating w.r.t. to \underline{x} , we obtain:

$$D\tilde{G}L\tilde{G}Lx \cdot DL(\tilde{G}Lx) \cdot D\tilde{G}(Lx) \cdot DLx = I$$

so that we can set

$$DLx = (D\tilde{G}(Lx))^{-1} \cdot (DL(\tilde{G}Lx))^{-1} \cdot (D\tilde{G}(L\tilde{G}Lx))^{-1}$$

In terms of the determinants we thus have

$$J_L(x) = J_{\tilde{G}}(Lx)^{-1} \cdot J_L(\tilde{G}Lx)^{-1} \cdot J_{\tilde{G}}(L\tilde{G}Lx)^{-1}$$

replacing $L\tilde{G}L$ by \tilde{G}^{-1}

$$1 = J_L(x) \cdot J_L(\tilde{G}Lx) \cdot J_{\tilde{G}}(Lx) \cdot J_{\tilde{G}}(\tilde{G}^{-1}x)$$

implying that

$$J_L(\tilde{G}Lx) = J_L(x)^{-1} \quad (2.8)$$

¹Hence, technically [26], \tilde{G} is not to be considered as the involution of L .

Defining the "phase space contraction rate" Λ as the logarithm of the inverse of the Jacobian of the Map

$$\Lambda(x, y) = \ln J_L^{-1}(x, y) \quad (2.9)$$

we may compute the adimensional average over a n -step trajectory, starting from the initial condition (x, y) , as follows:

$$\Lambda_n(x, y) = \sum_{k=0}^n \Lambda(L^k(x, y)) \quad (2.10)$$

It follows from Eq.(2.9), that , given a point (x, y) in the phase space, if we apply the involution operator \tilde{G} to $L(x, y)$, one obtains another point in the phase space giving the opposite contribution to the phase space contraction rate Λ since

$$\Lambda_n(x, y) = -\Lambda_n(\tilde{G}L(x, y)) \quad (2.11)$$

In other terms, for each trajectory producing a value of Λ there exist a trajectory producing the opposite value. This property is a kind of macroscopic "time-reversibility", despite the non standard form of eq (2.6)

In particular, since the map L consists in the composition of a rotation R with the map M_0 and since R is a rigid transformation which does not affect the area expansion-contraction given by the map M_0 , L preserves the phase space contraction rate Λ , as in Ref. [33, 35]. We remark that introducing $\Phi = \ln(|J_D|)$, where J_D is the the Jacobian of the L transformation in the D area ($x \in [\frac{3}{4}, 1]$) , one has $|J_D| = |J_A|^{-1}$, where J_A is the the Jacobian of the L transformation in the A area ($x \in [1, \frac{3}{4}]$), therefore we can write :

$$\Lambda(x, y) = \Lambda(x) = \begin{cases} -\Phi & \text{for } 0 \leq x < \ell \\ 0 & \text{for } \ell \leq x < \frac{1}{2} \\ 0 & \text{for } \frac{1}{2} \leq x < \frac{3}{4} \\ \Phi & \text{for } \frac{3}{4} \leq x < 1 \end{cases}$$

In the following we investigate the basins of attraction and the attractors given by these dynamics.

We aim to describe the attractors of the map and the related basins of attraction, and we will characterize them by the analysis of the Lyapunov exponents.

Figure 2.2 (on the left) shows the invariant sets of the map, i.e. the locus of points to which the phase space collaps in the steady state. They consist of

- two invariant regions (coloured in dark blue and green) which are characterized by null Lyapunov exponents
- a fixed point P_D characterized by two negative Lyapunov exponents
- two orthogonal lines labeled as C and D which have only one negative Lyapunov exponent along the direction orthogonal to the line, and a null exponent in the other direction.

More fixed points and cycles are present, which have not been inserted in the map since they are not attractors: a repulsive fixed point P_A in the region A (corresponding to $x \in [0, \ell]$) characterized by two positive Lyapunov exponents, and a repulsive (hyperbolic) cycle referred to AB orbit, constituted by two points, one in the A region and the latter in B (corresponding to $x \in [\ell, \frac{1}{2}]$).

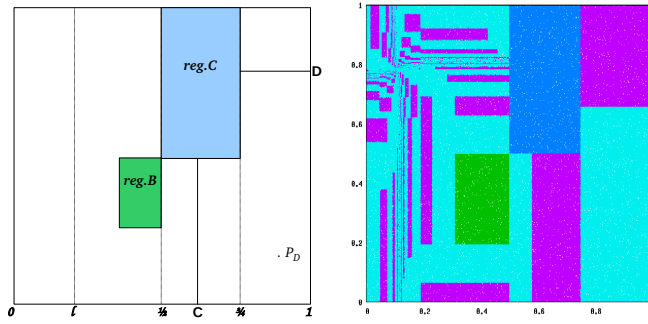

Figure 2.2: *Left panel:* the attractors of the Map. *Right panel:* the corresponding basins of attraction. Points in the area coloured in turquoise will converge in the steady state to the attractor P_D , while the points lying in the purple regions will collapse to the two orthogonal lines referred as $CDCD$. Those orbits are possible if the parameter $\ell \geq \frac{1}{8}$. Finally the green and blue regions are the so called "invariant" regions which do not collapse on any attractor and remain unchanged under the effect of our dynamics.

In the right side of figure 2.2 the basins of attraction of the attractors are represented. The area coloured in turquoise converges to the attractor P_D , while the points lying in the purple regions collapse on cycles constituted of 4 points each lying on the two orthogonal lines. We refer these cycles as $CDCD$ cycles. The central invariant regions coloured in blue and green, instead, are the same as the invariant regions coloured on the left. Indeed, points lying in this two areas will start moving in a period-4 cycle which will remain confined within the same borders. Thus these regions are invariant as it is easy to show analitically: applying 4 times the evolution operator to any point of such regions the dynamic returns to the starting point. While the B region is rectangular having edges which are function of the parameter ℓ , the C region remains instead fixed in time. Those regions can be easily computed analitically, imposing the suitable constraints.

We aim to compute the corresponding Lyapunov exponents along the x and y

axes: in other words we want to give an estimation of how an indetermination δ_0 on the two axes evolves in time in δ_t and letting the time go to infinity. It has to be taken in account that, since the dynamics (by the effect of the rotation) "mixes" at each step the coordinates of two axes, over a path of length τ the evolution will "stretch" the distances along the x-component of the Jacobian (as it did in the original M_0 map) for $\frac{n}{2}$ times, either contract them for $\frac{n}{2}$ times according to the y-component ($\delta y = \delta y(\delta x)$ and vice versa).

The jacobian matrix in the A region can be written as follows:

$$J_A = \begin{vmatrix} 0 & \frac{1}{2} \\ \frac{1}{2\ell} & 0 \end{vmatrix} \quad (2.12)$$

We may compute the Lyapunov exponent for the fixed point in the A region as

$$\begin{aligned} \lambda_x(x_A, y_A) &= \lim_{n \rightarrow \infty} \frac{1}{n} \ln \left| \prod_i^{n-1} M'(x_0) \right| = \\ &= \lim_{n \rightarrow \infty} \frac{1}{n} \ln \left[\left(\frac{1}{2\ell} \right)^{\frac{n}{2}} \left(\frac{1}{2} \right)^{\frac{n}{2}} \right] = \\ &= \lim_{n \rightarrow \infty} \frac{1}{2} \ln \left[\left(\frac{1}{2\ell} \cdot \frac{1}{2} \right) \right] = \\ &= \frac{1}{2} \ln \left(\frac{1}{4\ell} \right) = \lambda_y(x_A, y_A) \end{aligned} \quad (2.13)$$

which is positive $\forall \ell \in [0, \frac{1}{4}]$. It follows that such a fixed point in A is a repeller and consequently the dynamics will diverge all the trajectories away.

The fixed point coordinates in the contracting region are: $P_D = \left(\frac{1+3\ell}{(1+4\ell)}; \frac{1}{2(1+4\ell)} \right)$

The corresponding jacobian matrix in the D region can be written as

$$J_D = \begin{vmatrix} 0 & -2\ell \\ 2 & 0 \end{vmatrix} \quad (2.14)$$

With analogous arguments, the Lyapunov exponents for the fixed point (x_D, y_D) have been computed:

$$\begin{aligned} \lambda_x(x_D, y_D) &= \lim_{n \rightarrow \infty} \frac{1}{n} \ln \left| \prod_i^{n-1} M'(x_0) \right| = \\ &= \lim_{n \rightarrow \infty} \frac{1}{n} \ln \left[(2\ell)^{\frac{n}{2}} (2)^{\frac{n}{2}} \right] = \\ &= \lim_{n \rightarrow \infty} \frac{1}{2} \ln (4\ell) = \lambda_y(x_D, y_D) \end{aligned} \quad (2.15)$$

which is, on the opposite of $\lambda_{x,y}(x_A, y_A)$, is negative $\forall \ell \in [0, \frac{1}{4}]$.

Define $\lambda_A = \lambda_x(x_A, y_A) = \lambda_y(x_A, y_A)$, observe that $\lambda_A = -\lambda_D$, indeed the Lyapunov exponents, as the phase space contraction rate, are related to the inverse of the Jacobian [29]. This confirms that the fixed points P_A and P_D represent conjugated trajectories evolving respectively in the expanding and in the contracting volume regions.

For $\ell \geq \frac{1}{8}$ it is possible to show analitically that a pair of new conjugate trajectories of period 2 and 4 are possible. As conjugate trajectories, one of them jumps from the neutral area B to the expanding area in A producing on average a negative value for Λ , $\langle \Lambda \rangle = -\frac{\phi}{2}$, while the latter is alternatively stepping on the neutral C region and on the D contracting region producing a positive average $\langle \Lambda \rangle = \frac{\phi}{2}$.

From the computation of the Lyapunov exponents and from the dynamics emerges that the points on the AB orbits are hyperbolic attractors, thus the dyanmics will escape from such cycles. On the opposite, the CDCD periodic orbit will lie on two

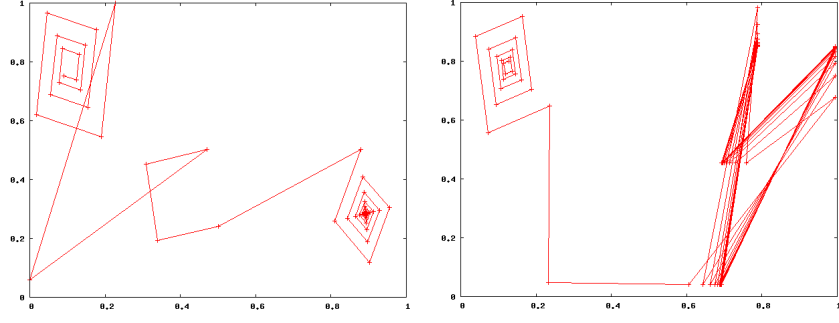

Figure 2.3: *Left Panel:* a sample of a trajectory starting in the surroundings of P_A and evolving towards P_D . *Right panel:* a sample of a trajectory evolving towards the $CDCD$ orbit.

orthogonal lines, labeled by C and D in the figure 2.2. Every point lying on those lines, in analogy with the invariant region, is a point of a period-4 cycle which jumps forever from the vertical line to the horizontal one, and viceversa. The computation of the corresponding Lyapunov exponents will in fact confirm that all the points of the periodic orbit will exhibit exponents 0 in the direction of the lines and negative in the orthogonal direction.

In the following, we compute the Lyapunov exponents for a point lying on the C line.

$$\begin{aligned}\lambda_x(x_{CDCD}, y) &= \lim_{n \rightarrow \infty} \frac{1}{n} \ln \left[(2\ell)^{\frac{n}{2}} (2)^{\frac{n}{2}} \right] = \\ &= \frac{1}{2} \ln(4\ell)\end{aligned}\tag{2.16}$$

which is negative $\forall \ell \in [0, \frac{1}{4}]$, and

$$\lambda_y(x_{CDCD}, y) = \lim_{n \rightarrow \infty} \frac{1}{n} \ln \left[(2)^{\frac{n}{2}} \left(\frac{1}{2} \right)^{\frac{n}{2}} \right] = 0\tag{2.17}$$

always. Analogously, we conclude that $\lambda_x(x, y_{CDCD}) = 0$ and $\lambda_y(x, y_{CDCD}) < 0$.

On the opposite, the conjugate trajectory AB is hyperbolic. Indeed the Lyapunov

exponents on the starting point in A of such cycle are :

$$\begin{aligned}\lambda_x(x_{AB}, y_{AB}) &= \lim_{n \rightarrow \infty} \frac{1}{n} \ln \left[(1 - 2\ell)^{\frac{n}{2}} \left(\frac{1}{2\ell} \right)^{\frac{n}{2}} \right] = \\ &= \frac{1}{2} \ln \left(\frac{1 - 2\ell}{2\ell} \right)\end{aligned}\quad (2.18)$$

which is positive for each $\ell \in [0, \frac{1}{4}]$, and

$$\begin{aligned}\lambda_y(x_{AB}, y_{AB}) &= \lim_{n \rightarrow \infty} \frac{1}{n} \ln \left[\left(\frac{1}{1} \right)^{\frac{n}{2}} \left(\frac{1}{1 - 2\ell} \right)^{\frac{n}{2}} \right] = \\ &= \frac{1}{2} \ln \left(\frac{1}{2(1 - 2\ell)} \right)\end{aligned}\quad (2.19)$$

which is instead always negative in the domain of ℓ .

Notice that $(\lambda_x + \lambda_y)_{AB} = -(\lambda_x + \lambda_y)_{CDCD}$ which confirms that such orbits are conjugated, which in terms of $\langle \Lambda \rangle$ means that they produce opposite values.

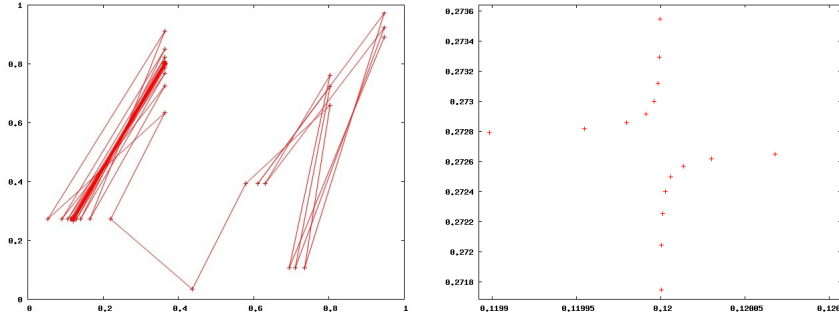

Figure 2.4: *Left panel:* a sample of a trajectory escaping from the AB repulsive cycle and collapsing on the attractive CDCD attractive cycle. In the stationary state, the AB cycle and the CDCD cycle are conjugated trajectories, i.e. the sum of the lyapunov exponents in the x and y components are opposite, $(\lambda_x + \lambda_y)_{AB} = -(\lambda_x + \lambda_y)_{CDCD}$. *Right panel:* detail of a trajectory in the surrounding of the hyperbolic point P_A .

In the figures 2.3, a sample of trajectories starting in the surrounding of the repulsive fixed point P_A and attracted by the two different attractors (the fixed point P_D on the left and the $CDCD$ orbit on the right) are shown.

Moreover the orbits in the surrounding of the hyperbolic points have been investigated: we have been focusing on the search of chaotic trajectories around the unstable hyperbolic points, which would have suggested the presence of strange hyperbolic long-period cycles.

In the figure 2.4, on the right, is presented an example which clearly exhibit a non chaotic trajectory around the unstable point which follows a simple hyperbola, suggesting that no other attractors are present.

2.3 Basins of attraction, dependence on ℓ

We analyze the basins of attraction of the different attractors as a function of the parameter ℓ . Figure 2.5 shows the basins of attraction for $\ell = 0.2$: the blue and purple regions correspond to the set of points which fall on the invariant region B and C described in the previous file. The phase space area coloured in green correspond to the set of points whose dynamics collapse on the D fixed point (attractor), P_D whose coordinates depend parametrically on ℓ as

$$P_D = \left(\frac{1 + 3\ell}{1 + 4\ell}, \frac{1}{2(1 + 4\ell)} \right).$$

The remaining areas, coloured in red, correspond instead to the basins of attraction of the so-called CDCD orbits mentioned in the previous map description file, forming a fractal around the unstable fixed point in A, P_A whose coordinates are given by

$$P_A = \left(\frac{\ell}{1 + 4\ell}, \frac{1 + 2\ell}{1 + 4\ell} \right)$$

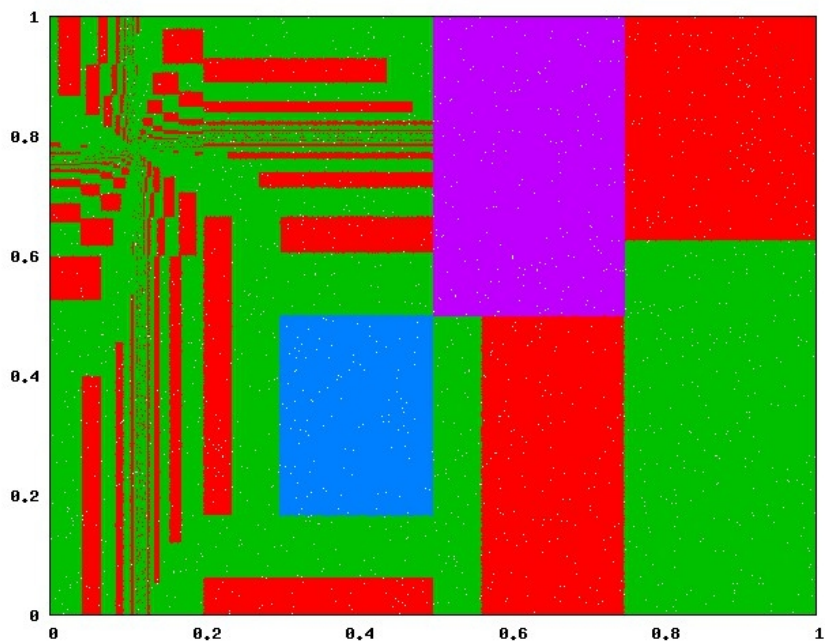

Figure 2.5: Basins of attraction for the Map in Eq.(2.1) for $\ell = 0.2$.

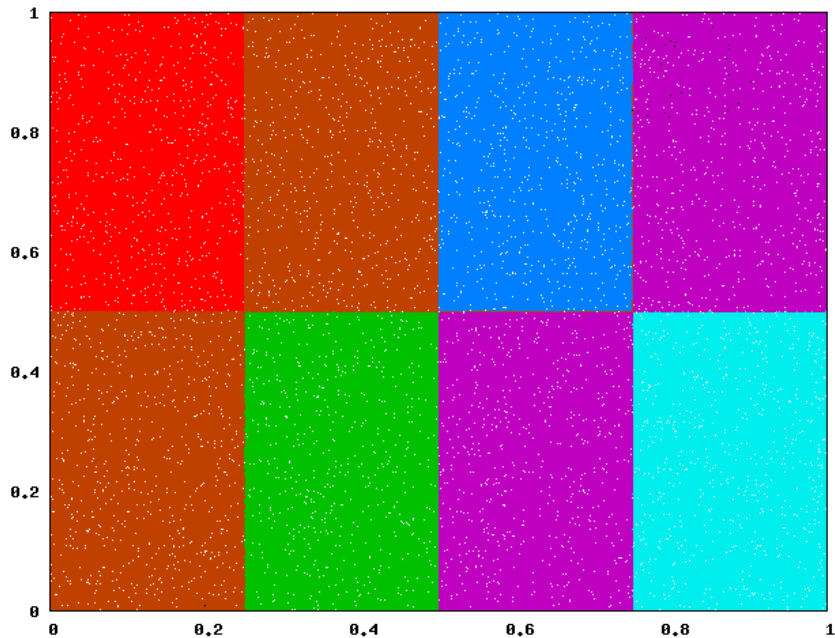

Figure 2.6: The microcanonical equilibrium corresponding to $\ell = 0.25$. No attractors are present, all the Lyapunov exponents are zero and all the points are part of a period 4 cycle which steps just on the same colour area.

In the “neutral” regions B and C, the basin of attraction can be computed imposing at each time step the validity of the general conditions, respectively $x \in [\ell, \frac{1}{2}]$ to belong to B and $x \in [\frac{1}{2}, \frac{3}{4}]$ to belong to C over all the additive conditions imposed by the evolution. If the final point after three step will remain in B or in C, then the evolution will bring automatically the point back to the starting point closing a 4 period cycle. The locus of points satisfying such conditions depend parametrically on ℓ :

$$\frac{1}{2(1-2\ell)} \leq x \leq \frac{1}{2} \quad \text{and} \quad \frac{4\ell-1}{4\ell-2} \leq y \leq \frac{1}{2}$$

Analogously, for the C neutral region, the basin of attraction is given by:

$$\frac{1}{2} \leq x \leq \frac{3}{4} \quad \text{and} \quad \frac{1}{2} \leq y \leq 1.$$

No dependence on the parameter is present in this case.

Coherently with the expectations, the convergence time, i.e. the number of time-steps necessary for a trajectory to fall on an attractor, sensibly increases as the parameter ℓ approaches the equilibrium value $\ell = 0.25$.

The basins of attraction, at the same time, are regions where the entire trajectory takes place before falling (very rapidly) on the attractors. This can be also understood by noticing that, if a trajectory would ”step” on a different region belonging to a different basin of attraction, such a point could be ipothetically be the starting point of a new trajectory which collapse on a different attractor.

In the sequences of figures 2.7 it is possible to notice the variation of the size of the basins of attractions for increasing values of the parameter ℓ , in the whole range of values $[0, \frac{1}{4}]$, where $\ell = \frac{1}{4}$ corresponds to the condition of “equilibrium” and $\ell = 0$ corresponds to the most nonequilibrium dynamics. In such case, apart from the

“neutral” region C which is independent from the parameter ℓ , the rest of the whole phase space coincides with the basin of attraction of the stable fixed point P_D .

The basins of attraction of the equilibrium condition are shown in the figure 2.6: it is possible to notice that in this case there are no attractors, all the Lyapunov exponents vanish and all the points are driven onto period 4 cycles stepping always on the same colored regions. The whole range of values of the parameter ℓ has been spanned by considering a bin size corresponding to 0.01, cf. Fig. 2.7. For each of them it has been computed the mean values of Λ over an ensemble of 10^6 , randomly selected, trajectories. In figure 2.12, we show some specific examples corresponding to rational value for the parameter ℓ : $\ell = \frac{1}{4} - \frac{1}{n}$.

The dynamics enjoys a strongly dissipative behaviour, $\langle \Lambda \rangle > 0$.

2.4 Phase Space contraction rate in the steady state

Let us consider a generic dynamical system (\mathcal{U}, ϕ, μ) and label the coordinates y as the generic evolution of a point x at the initial state, so that we may write:

$$y = \phi^t(x) \Rightarrow dy = \left| \frac{d\phi^t}{dx} \right| (x) dx = J(x) dx.$$

Suppose, as in our case, that the dynamical system has a numerable set of attractors and denote with Ω_i the i^{th} attractor and with $\Omega_{0,i}$ the correspondent basin of attraction, so that:

$$\Omega_i = \lim_{t \rightarrow \infty} \phi^t(\Omega_{0,i}).$$

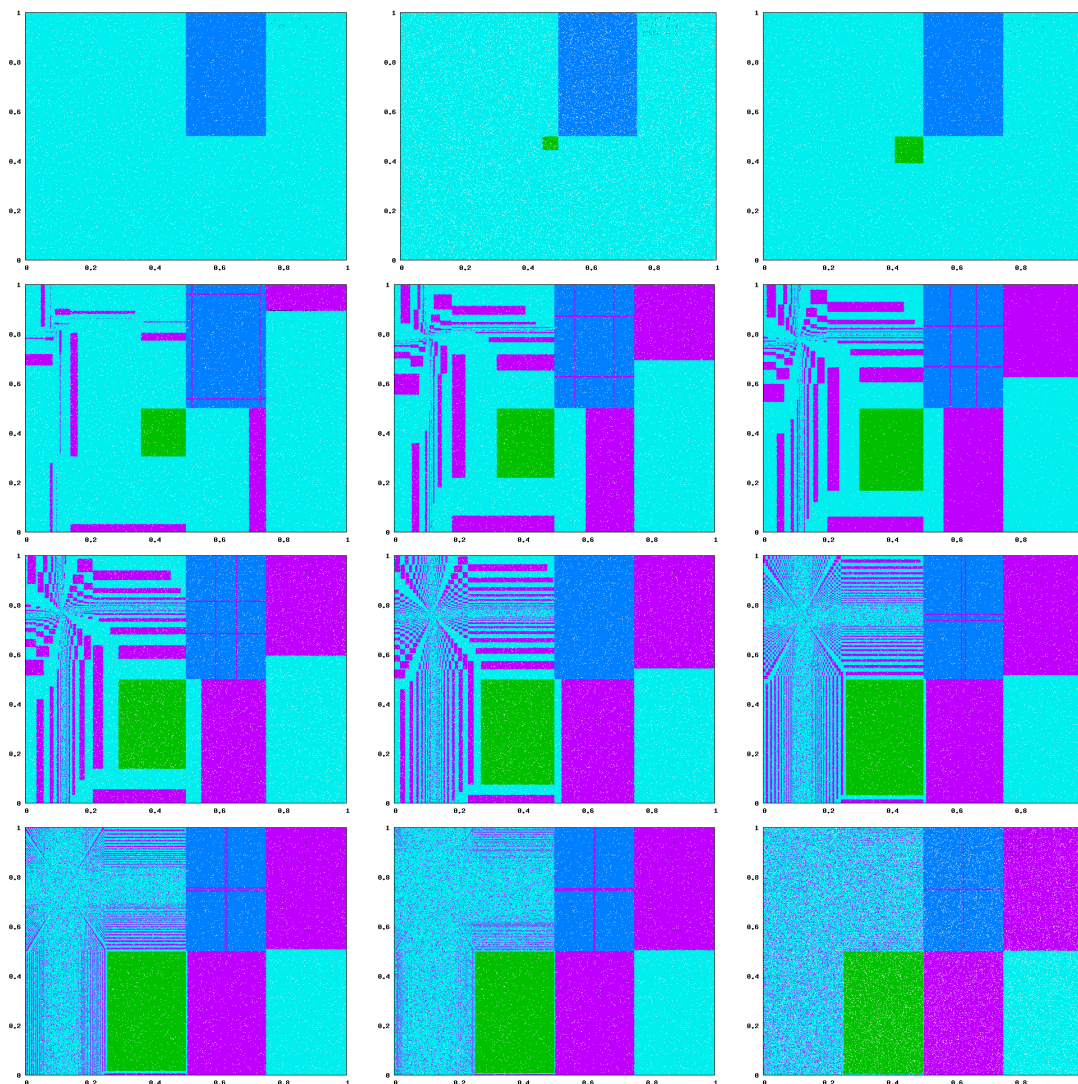

Figure 2.7: Dependence of basins of attraction for increasing values of ℓ . The blue and green regions correspond to the invariant regions, the turquoise region instead is the basin of attraction of the fixed attractive point P_D . From the second line, i.e. from $\ell \geq \frac{1}{8}$ the basins of attraction of CDCD orbits show up in purple, building a fractal around the unstable fixed point P_A . *From left to right, top to the bottom:* $\ell = 0,0001$, $\ell = 0,05$, $\ell = 0,09$; $\ell = 0,14$, $\ell = 0,18$ $\ell = 0,20$; $\ell = 0,021$ $\ell = 0,23$, $\ell = 0,242$; $\ell = 0,246$ $\ell = 0,248$, $\ell = 0,249$.

For any given set D_0 , which evolves according to the evolution law ϕ , such that $D_t = \phi^t(D_0)$, the measure conservation property may be expressed as

$$\mu_t(D_t) = \mu_0(D_0).$$

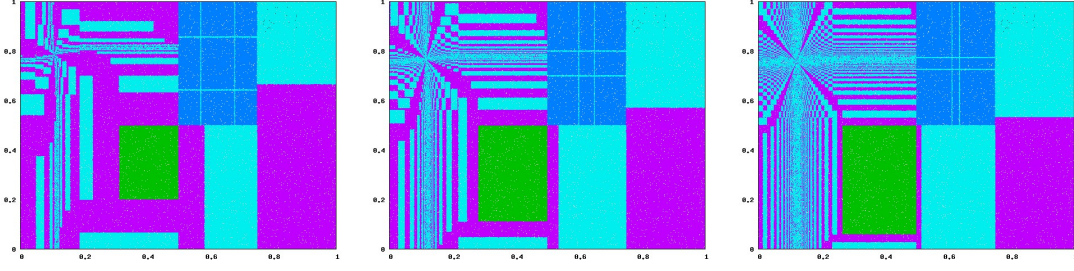

Figure 2.8: Dependence of basins of attraction for increasing values of $\ell = \frac{1}{4} - \frac{1}{n}$, $n > 3$. From left to right: $\ell = \frac{1}{4} - \frac{1}{16}$, $\ell = \frac{1}{4} - \frac{1}{32}$, $\ell = \frac{1}{4} - \frac{1}{64}$

In the steady state regime, due to the symmetry of the measure μ under the time reversal, the following relation holds, $\forall t$:

$$\mu(D_t) = \mu_t(D_t) = \mu_0(D_0)$$

Similarly:

$$\mu(\Omega_i(\ell)) = \mu_0(\Omega_{0,i}(\ell)) \quad (2.20)$$

If we suppose that a measure exists, absolutely continue with respect to the Lebesgue measure, taking into account that $x = \Phi^{-t}y$ so that

$$\int_{\Omega_i} \rho(y)dy = \int_{\Omega_{0,i}} \rho_0(x)J(x)dx$$

and by also assuming that $\forall i$ the attractor corresponds to a periodic orbit yielding, over one period, an average value $\langle \Lambda \rangle_i = \Lambda_i$, which is constant in time, for an initial uniform ensemble covering the whole phase space, we may write:

$$\langle \Lambda \rangle_{\ell, \mathcal{U}} = \sum_i \mu(\Omega_{0,i}(\ell)) \Lambda_i(\ell) \quad (2.21)$$

We aim to use this general result in our dynamical system. To derive it, let $\Omega_{0,i}(\ell)$

be the basins of attraction of the corresponding attractor $\Omega_i(\ell)$:

$$\Omega_i(\ell) = \lim_{k \rightarrow \infty} \Phi^k(\Omega_{0,i}(\ell))$$

$i \in [1, N_\ell]$, where N_ℓ denotes the total number of attractors according to the parameter ℓ . As previously mentioned, the dynamics is neither chaotic nor ergodic (the Lyapunov exponents are negative or vanish almost everywhere), hence steady state fluctuations of the phase space contraction rate are prevented.

The computation of the Λ average, which is normally computed at the steady state as

$$\langle \Lambda \rangle_\ell = \int_{\mathcal{U}} \Lambda(x, y) d\mu(x, y)$$

w.r.t. the so called SRB measure μ (i.e. ‘‘Sinai Ruelle Bowen measure’’ [27], the invariant measure having support on the attractor), may be alternatively reduced to a discrete set of possible constant values.

We remark here that, because of the non-ergodicity, we refer to $\langle \Lambda \rangle_{\mathcal{U}}$ as the whole phase space ensemble average (in other terms as the average of the phase space contraction rate computed for independent initial conditions) which does not correspond to the average of an infinite long evolution trajectory for a single system.

It is then possible to summarize the average phase space contraction rates, pertinent to the different attractors, as follows:

in case $\ell > \frac{1}{8} \Rightarrow N_\ell = 6$

$$\Lambda_i(\ell) = \langle \Lambda \rangle_{i,\ell} = \int_{\Omega_i(\ell)} \Lambda(x, y) d\mu(x, y) = \begin{cases} \Phi, & \Omega_1(\ell) \equiv P_{\mathcal{D}} \\ \frac{\Phi}{2}, & \Omega_2(\ell) \equiv \mathcal{C}\mathcal{D}\mathcal{C}\mathcal{D} \\ 0, & \Omega_3(\ell) \equiv \mathcal{B} \\ 0, & \Omega_4(\ell) \equiv \mathcal{C} \\ -\Phi, & \Omega_5(\ell) \equiv P_{\mathcal{A}} \\ -\frac{\Phi}{2}, & \Omega_6(\ell) \equiv \mathcal{A}\mathcal{B} \end{cases} \quad (2.22)$$

and, in case $\ell \leq \frac{1}{8} \Rightarrow N_\ell = 4$

$$\Lambda_i(\ell) = \langle \Lambda \rangle_{i,\ell} = \int_{\Omega_i(\ell)} \Lambda(x, y) d\mu(x, y) = \begin{cases} \Phi, & \Omega_1(\ell) \equiv P_{\mathcal{D}} \\ 0, & \Omega_2(\ell) \equiv \mathcal{B} \\ 0, & \Omega_3(\ell) \equiv \mathcal{C} \\ -\Phi, & \Omega_4(\ell) \equiv P_{\mathcal{A}} \end{cases} \quad (2.23)$$

In particular, we may reduce the computation of the steady state average $\langle \Lambda \rangle$ over the whole phase space \mathcal{U} , to an average of $\Lambda_i(\ell)$ weighted on the Lebesgue measure of the basins of attraction at the initial state (the use of the Lebesgue measure is implied by the fact that we started with a uniform microcanonical distribution on \mathcal{U}). In this particular case, we may associate to each attractor $\Omega_i(\ell), i \in [1..N_\ell]$ a corresponding value $\Lambda_i(\ell)$, which yields:

$$\begin{aligned}
\langle \Lambda \rangle_{\ell, \mathcal{M}} &= \sum_{i=1}^{N_\ell} \int_{\Omega_i(\ell)} \Lambda_\ell(x, y) d\mu(x, y) = \\
&= \sum_{i=1}^{N_\ell} \int_{\Omega_i(\ell)} \Lambda_i(\ell) d\mu(x, y) = \\
&= \sum_{i=1}^{N_\ell} \Lambda_i(\ell) \mu(\Omega_i(\ell)) = \\
&= \sum_{i=1}^{N_\ell} \Lambda_i(\ell) \mu_0(\Omega_{0,i}(\ell)). \tag{2.24}
\end{aligned}$$

where $\mu_0(\Omega_{0,i}(\ell))$ denotes the Lebesgue measure of the basins of attraction, which depends solely on the dynamics.

In our case, taking into account that P_A or \mathcal{AB} have 0 Lebesgue measure since they are repulsors, and moreover, considering that the invariant regions \mathcal{B} and \mathcal{C} produce a zero contribution of Λ , as we write $\Phi_\ell = \ln(|J_D|) = \ln(4\ell)$, the following relation holds:

$$\langle \Lambda \rangle_{\ell, \mathcal{M}} = \ln(4\ell) \left[\mu(\Omega_{0, P_D}(\ell)) + \frac{\mu(\Omega_{0, CDCD}(\ell))}{2} \right].$$

2.5 Analysis of the Transient FR

We may consider the map “reversible” in the sense that, for any given number of steps, we may identify, for each single trajectory producing a possible value of $\langle \Lambda \rangle$, a conjugated trajectory producing exactly the opposite value. In other words, for any possible value of $\langle \Lambda \rangle$ it exist a couple of (non-zero measure) sets of points representing the initial conditions of n -steps trajectories which produce opposite values. It is possible to compute exactly those sets in the phase space simply iterating

the map for n steps with the following constraints:

- the trajectory must produce a possible value of $\langle \Lambda \rangle \in [-n\Phi, n\Phi]$
- not all the transitions are possible
- at the n^{th} step all the constraints of the previous steps (from the 0 step until the $n^{\text{th}-1}$) must still hold

On the other hand, we numerically investigated, for different values of the ℓ parameter, such reversibility condition in order to validate the FR in the transient regime. If we identify the probability to get, over a n step trajectory, the average phase space contraction rate $\langle \Lambda \rangle = A$ with $P_n(\langle \Lambda \rangle = A)$, the transient FR could be schematically synthesized in the following form:

$$\frac{P_n(\langle \Lambda \rangle = A)}{P_n(\langle \Lambda \rangle = -A)} = e^{n \cdot A}$$

which is supposed to hold generally for any finite number of step.

We noticed an interesting feature of our model: for $n = 1$, for an arbitrary value of the parameter ℓ , the FR is fulfilled, whereas, for $n = 2$, the FR does not hold anymore. Thus, the Transient FR does not hold. The interesting observation is that, when increasing the length of the trajectory, the FR is apparently restored: the Transient FR, which, under special mathematical requirements, holds for any length of the trajectory, is here fulfilled just in the long time range. For small values of the parameter, when the dynamics is very dissipative, the FR holds for trajectories of very few time-steps. On the opposite, increasing the parameter ℓ , i.e. pointing towards equilibrium, the FR is fulfilled only for large numbers of steps.

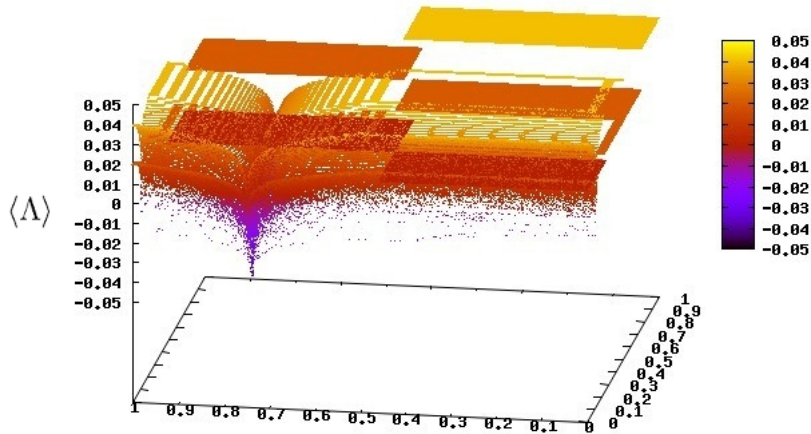

Figure 2.9: 3D-Distribution of the average phase space contraction rate for $\ell = 0.24$ over a trajectory of 250 steps, starting from a microcanonical ensemble composed of one million points.

As it is possible to notice from the figure 2.9, starting from a point close to the repeller P_A , the dynamics is confined, for longer times, within the expanding region, which, hence, leads to the onset of the most negative values of $\langle \Lambda \rangle$, over the n steps.

Provided that the considered dynamical system is not ergodic, we cannot recover the FR, although, asymptotically, our numerical results show that the latter is actually fulfilled. On the left of figure 2.12, the points effectively lying on the bisector are those which fit the FR, and the corresponding distribution of $\langle \Lambda \rangle$ on the map is also shown.

2.6 Conclusions

The model considered in this work is not an Axiom-A system, because the attractor is constituted by a simple “sink”, characterized by a pair of negative Lyapunov

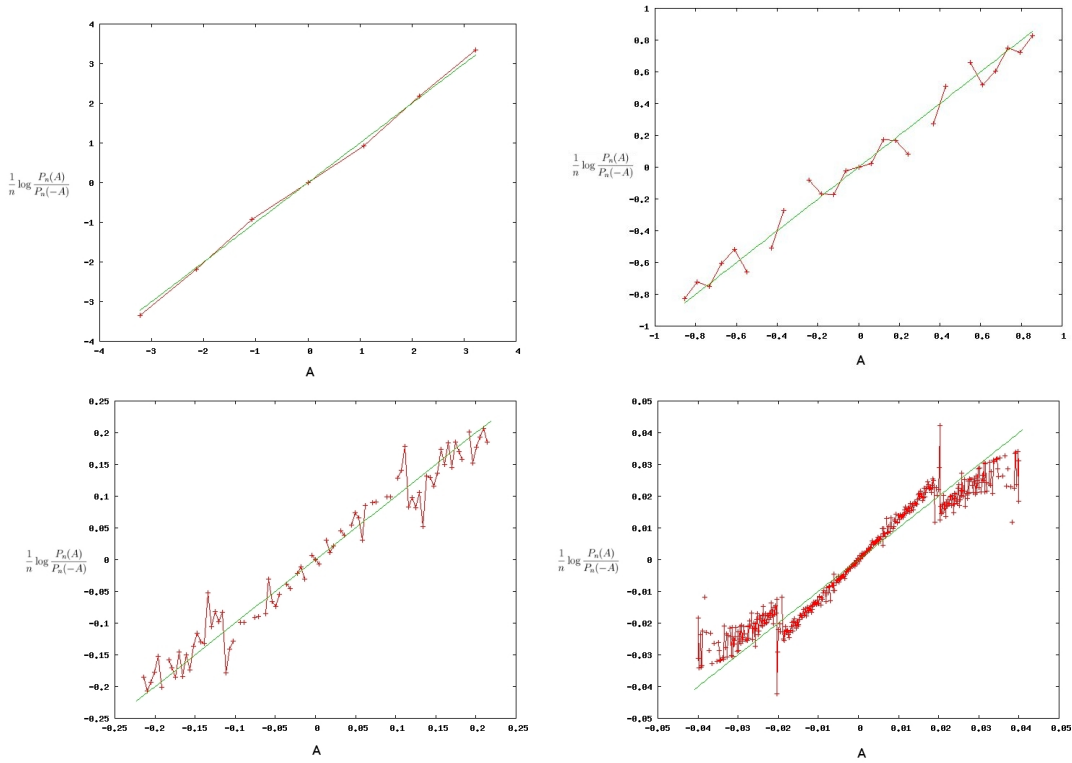

Figure 2.10: FR restored in the long time limit for different ℓ values. The points lying close to the bisector are the ones that best interpolate the Fluctuation Relation. From left to right, top to the bottom: $\ell = 0,001$ and $Nstep = 3$, $\ell = 0,1$ and $Nstep = 15$, $\ell = 0,2$ and $Nstep = 50$; $\ell = 0,24$ and $Nstep = 250$.

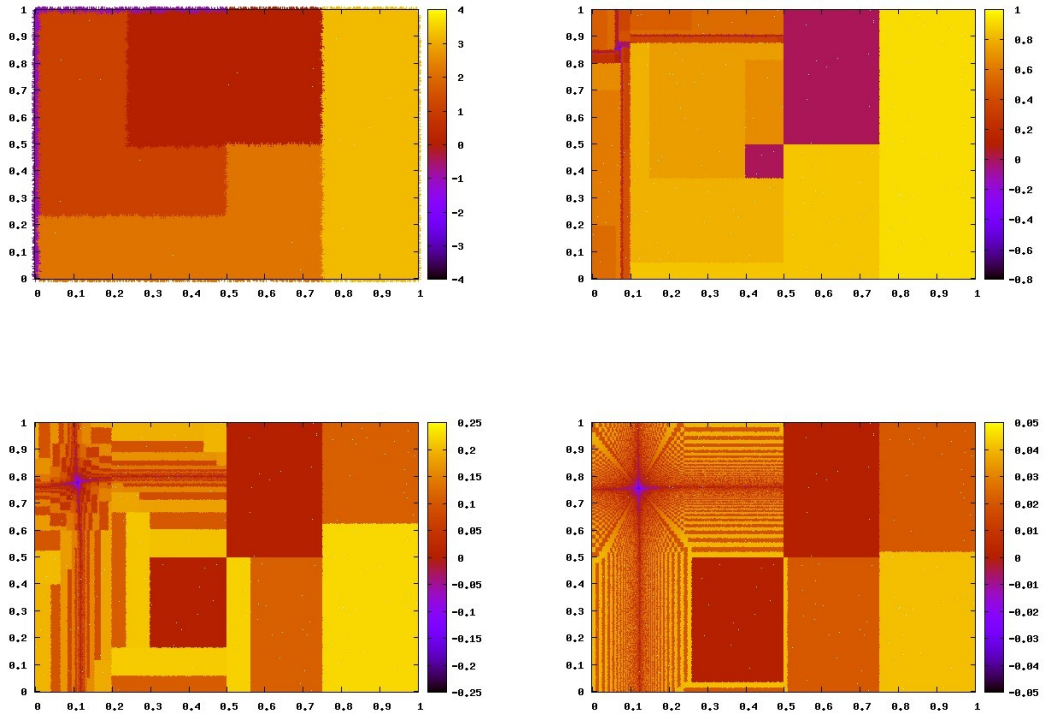

Figure 2.11: Contour plot of the distribution of the average phase space contraction rate for increasing values of ℓ . The dark black and purple colours around the repeller represent the locus of points which produce in the transient regime the most negative values. The length of the trajectory depend on the ℓ parameter and was chosen as the most suitable to validate the FR. *From left to right, top to the bottom:* $\ell = 0,001$ $Nstep = 3$, $\ell = 0,1$ $Nstep = 15$, $\ell = 0,2$ $Nstep = 50$; $\ell = 0,24$ $Nstep = 250$.

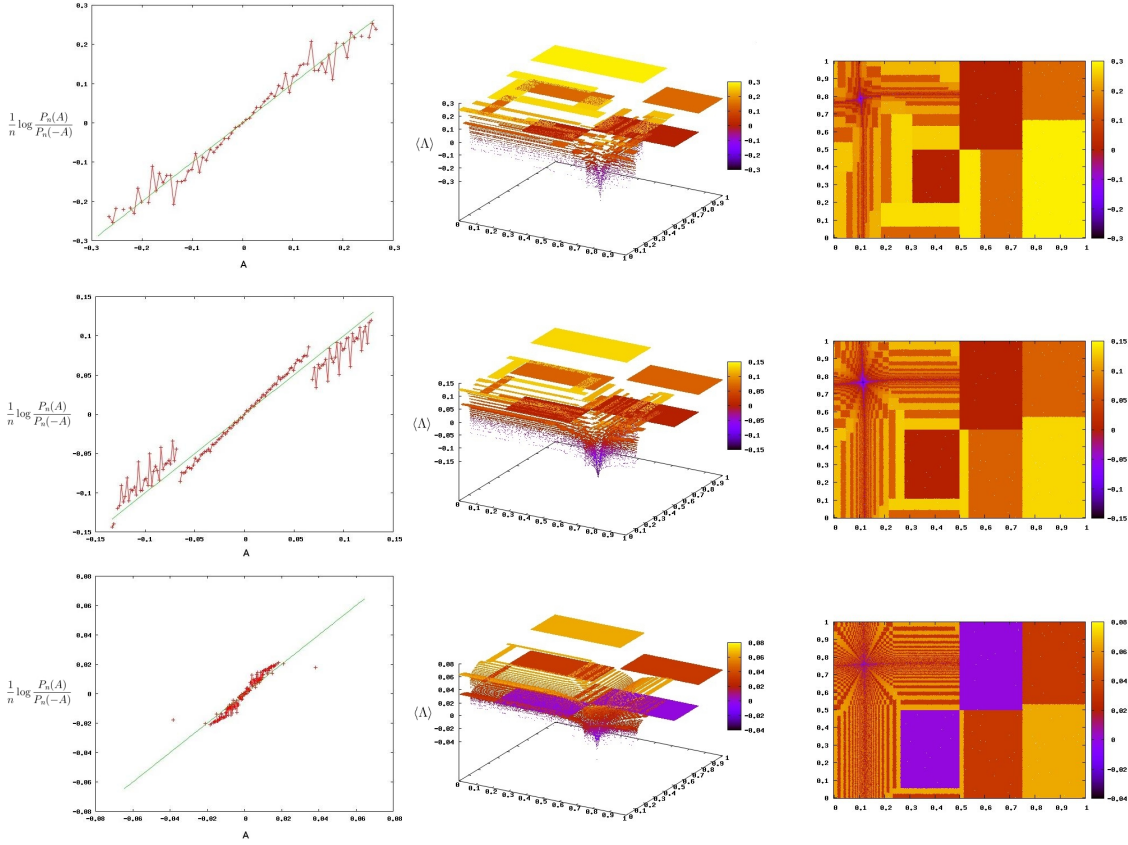

Figure 2.12: On the left, the points lying on the bisector correspond to couples of trajectories and antitrajectories whose probabilities validate the Transient Fluctuation Relation. In the center of the page the 3D distribution of $\langle \Lambda \rangle$ and on the right the corresponding contour plot for (from top to the bottom): $l = \frac{1}{4} - \frac{1}{16}$, $l = \frac{1}{4} - \frac{1}{32}$, $l = \frac{1}{4} - \frac{1}{64}$

exponents. Hence, the steady state dynamics can not lead to fluctuations in the observable Λ . Nevertheless, the model turned out to be a useful tool to test the sufficient hypothesis typically invoked along the derivation of the transient FR. As it is illustrated in [16], the transient Fluctuation Relation steps up as a simple identity in reversible systems in which the initial distribution may be thought of as generated by a single infinitely long trajectory visiting all the phase space regions. Our dynamical system fulfill, even though in a suitable weaker form, the reversibility condition, but it breaks down the ergodic condition: in fact, at equilibrium all the points belong to a period-4 cycle and the phase space is fragmented. The theory guarantees that if the hypothesis of reversibility and ergodicity of the equilibrium state hold, the transient FR holds for any number of steps. Our dynamical system, because of the lack of ergodicity at equilibrium, underlines the role played by the ergodicity, which, hence, stems as a necessary condition. Nevertheless, an important observation, resulting from our numerical simulations, indicates that the FR is restored in the asymptotic long time limit, cf. fig. 2.12. What we can say it is that this property is, possibly, not immediately related to the standard transient FR, which must actually hold for an arbitrary number of steps, it may emerge because of the peculiar underlying features of the microscopic dynamics. This corroborates the idea that FRs may generally extend their applicability over their mathematical requirements, opening new future challenging perspectives in the understanding of dissipative processes.

Chapter 3

Applications of the dissipation function: t-mixing and the dissipation theorem

The convergence of statistical ensembles to equilibrium density in non dissipative dynamical systems, i.e. in systems which preserve globally phase space volumes, has been widely studied in literature. In the framework of statistical mechanics, from the celebrated Boltzmann' H-theorem to the modern ergodic theory, several approaches concerning different working hypothesis have been proposed and discussed. In 1968 Arnold and Avez [1] showed that reversible dynamics may lead to irreversible behaviour under the mixing hypothesis. Indeed, in the long time limit, the initial density relaxes to a unique equilibrium density which turns out to be the well-known microcanonical distribution.

It has been recently introduced by Evans and Searles [6, 5] a new dynamical prop-

erty which was labeled as *t-mixing* to underline the similarity in shape with the original mixing condition. We show the advantages of such definition in the study of convergence to steady state and eventually to equilibrium.

The determination of the t-mixing hypothesis follows a certain amount of preliminary results: we remark the derivation of the transient and steady state fluctuation relation for the Ω dissipation function as discussed in reference [16]. We present here the Dissipation Theorem (DT) [18], which describes the response of a system under the effect of the dynamics, and its implications in terms of convergence to equilibrium for t-mixing systems.

3.1 General setting

Let \mathcal{M} be the phase space of a time reversal invariant dynamical system, and let be $S^t : \mathcal{M} \rightarrow \mathcal{M}$ the time evolution operator which takes any point $\Gamma \in \mathcal{M}$ to its corresponding image $S^t\Gamma$, solution of the equation of motion. By *time reversible dynamics*, we assume it exist an *involution* operator representing the time inversion operator $i : \mathcal{M} \rightarrow \mathcal{M}$ such that:

$$iS^t\Gamma = S^{-t}i\Gamma \quad \forall \Gamma \in \mathcal{M}, t \in \mathcal{R} \quad (3.1)$$

$$ii = i^2 = \mathcal{I} \quad (3.2)$$

Assuming the dynamics given by $\dot{\Gamma} = G(\Gamma)$, we refer to Λ as the phase space contraction rate as

$$\Lambda(\Gamma) = \text{div}G(\Gamma) \quad (3.3)$$

or in integrated form over a trajectory starting at time 0 and lasting at time s :

$$\Lambda_{0,s}(\Gamma) = \int_0^s \Lambda(S^u \Gamma) du \quad (3.4)$$

In order to obtain the Transient Fluctuation Relation (TFR), we must introduce the integral of the Dissipation Function $\Omega^{(0)}$ as following:

Definition 1. *the time-averaged dissipation function for a time reversal invariant phase space probability density $f^{(0)}$ is defined by*

$$\Omega_{0,s}^{(0)}(\Gamma) = \int_0^s \Omega^{(0)}(S^u \Gamma) du = \ln \frac{f^{(0)}(\Gamma)}{f^{(0)}(iS^s \Gamma)} - \Lambda_{0,s}(\Gamma)$$

where the superscript (0) refers to the initial probability density. This definition implies:

$$\Omega^{(0)}(\Gamma) = \lim_{s \rightarrow 0} \frac{1}{s} [\ln f^{(0)}(\Gamma) - \ln f^{(0)}(iS^s \Gamma)] - \Lambda(\Gamma) \quad (3.5)$$

Then either

$$\lim_{s \rightarrow 0} [\ln f^{(0)}(\Gamma) - \ln f^{(0)}(iS^s \Gamma)] = \ln f^{(0)}(\Gamma) - \ln f^{(0)}(i\Gamma) = 0 \quad (3.6)$$

i.e. $f^{(0)}$ is even under time reversal, or is everywhere singular. If one accepts this (mathematically rather peculiar) possibility, one further observes that $\Omega^{(0)}$ is not simply related to the dissipative flux. However, the TFR holds for all initial densities. If, on the other hand, is even under time reversal, one has:

$$\Omega_{0,s}^{(0)}(\Gamma) = \ln \frac{f^{(0)}(\Gamma)}{f^{(0)}(iS^s \Gamma)} - \Lambda_{0,s}(\Gamma) = \ln \frac{f^{(0)}(\Gamma)}{f^{(0)}(S^s \Gamma)} - \Lambda_{0,s}(\Gamma) \quad (3.7)$$

and $\Omega^{(0)}$ and may be written as:

$$\Omega^{(0)}(\Gamma) = \frac{d}{d\Gamma} \ln f^{(0)} \Big|_{\Gamma} \cdot \dot{\Gamma} - \Lambda(\Gamma) = \frac{d}{d\Gamma} \ln f^{(0)} \Big|_{\Gamma} \cdot G(\Gamma) - \Lambda(\Gamma) \quad (3.8)$$

or

$$\Omega(\Gamma) = \frac{1}{f^{(0)}} \frac{d}{d\Gamma} f^{(0)} \Big|_{\Gamma} \cdot G(\Gamma) - \Lambda(\Gamma) = \frac{1}{f^{(0)}} \frac{\partial f^{(t)}}{\partial t} \Big|_0 \quad (3.9)$$

because the Liouville equation, in this case, is given by

$$\frac{\partial f^{(t)}}{\partial t}(\Gamma) = -\text{div} G(\Gamma) f^{(t)}(\Gamma) - G(\Gamma) \cdot \frac{d}{d\Gamma} f^{(t)}(\Gamma) \quad (3.10)$$

It is convenient, in what follows, to adopt Eq.(3.7), whether is time reversal invariant or not. Then the TFR does not hold for non-even , but is defined. For the time evolution of a probability density, one has:

$$f^{(t)}(\Gamma) = e^{-\Lambda_{-t,0}(\Gamma)} f^{(0)}(S^{-t}\Gamma) \quad (3.11)$$

Substituting the definition of $\Omega^{(0)}$ yields:

$$f^{(t)}(\Gamma) = e^{\Omega_{-t,0}^{(0)}} f^{(0)}(\Gamma) \quad (3.12)$$

which is due to the equalities:

$$\Lambda_{0,t}(\Gamma) = \ln \frac{f^{(0)}(\Gamma)}{f^{(0)}(S^t\Gamma)} - \Omega_{0,t}^{(0)}(\Gamma) \quad \Lambda_{0,-t}(\Gamma) = \ln \frac{f^{(0)}(\Gamma)}{f^{(0)}(S^{-t}\Gamma)} = -\Lambda_{-t,0} \quad (3.13)$$

Equation (3.12) implies:

$$\langle \Omega^{(0)} \rangle_0 = \int \Omega^{(0)}(\Gamma) f^{(0)}(\Gamma) d\Gamma = \int \left. \frac{\partial}{\partial t} f^{(t)}(\Gamma) \right|_{t=0} d\Gamma = \left. \frac{\partial}{\partial t} \int f^{(t)}(\Gamma) \right|_{t=0} d\Gamma = 0 \quad (3.14)$$

for any $f^{(0)}$. Here, 0 appears twice in the left hand side, because the phase function $\Omega^{(0)}$, defined with respect to the initial distribution is averaged with respect to the initial distribution. Of course, $\Omega^{(0)}$ can be averaged with respect to any probability measure, in which case we write:

$$\langle \Omega^{(0)} \rangle_t = \int \Omega^{(0)}(\Gamma) f^{(t)}(\Gamma) d\Gamma \quad (3.15)$$

Note also that $\int d\Gamma f^{(0)} A(S^s \Gamma) = \int d\Gamma f^{(s)} A(\Gamma)$.

Now, consider that:

$$\int_0^t \Omega^{(0)}(S^u \Gamma) du = [\text{let } z = u - s] = \int_0^t \Omega^{(0)}(S^{s+z} \Gamma) du = \int_0^{t-s} \Omega^{(0)}(S^z S^s \Gamma) dz \quad (3.16)$$

Hence, denoting $\exp \left[\int_s^t \Omega^{(0)}(S^u \Gamma) du \right] = A^{(t-s)}(S^s \Gamma) = A^{t-s} \circ S^s(\Gamma)$ one obtains:

$$\langle e^{-\Omega_{s,t}^{(0)}} \rangle_0 = \int d\Gamma A^{(t-s)}(S^s \Gamma) f^{(0)}(\Gamma) = \int d\Gamma A^{(t-s)}(\Gamma) f^{(s)}(\Gamma) = \langle e^{-\Omega_{0,t-s}^{(0)}} \rangle_s \quad (3.17)$$

In order to stress the fact that observables do not depend on time, but only on phases, it is convenient at times to write $O \circ S^s$ when the function O has to be evaluated at in the phase $S^s \Gamma$; in other words, to write $O \circ S^s(\Gamma) = O(S^s \Gamma)$. Using Eq.(3.7) for all initial distributions, initial distributions evolve according to Eq.(3.12), with time derivative given by:

$$\left. \frac{d}{ds} f^{(s)}(\Gamma) \right|_t = f^{(0)}(\Gamma) e^{-\Omega_{-t,0}^{(0)}(\Gamma)} \frac{d}{dt} \int_{-t}^0 \Omega^{(0)}(S^s \Gamma) ds = f^{(0)}(\Gamma) e^{\Omega_{-t,0}^{(0)}(\Gamma)} \Omega^{(0)}(S^{-t} \Gamma) \quad (3.18)$$

3.2 Response

We aim to compute the response of the given system for an arbitrary observable O by computing the corresponding average with respect to the probability distribution at time $t > 0$. Response is expressed by:

$$\langle O \rangle_t = \int_M O(\Gamma) f^{(t)}(\Gamma) d\Gamma = \int_M O(\Gamma) e^{\Omega_{-t,0}^{(0)}} f^{(0)} d\Gamma \quad (3.19)$$

with variation with respect to its initial value

$$\langle O \rangle_0 = \int_M O(\Gamma) f^{(0)}(\Gamma) d\Gamma \quad (3.20)$$

given by

$$\langle O \rangle_t - \langle O \rangle_0 = \int_M O(\Gamma) \{e^{\Omega_{-t,0}^{(0)}} - 1\} f^{(0)} d\Gamma \quad (3.21)$$

We state the following

Lemma 3.2.1. *Let $\Omega^{(0)}$ be the dissipation function defined in definition (1), and let*

$\langle \cdot \rangle_s = \int_{\mathcal{M}} \cdot f^{(s)} d\Gamma$ be the ensemble average computed with respect to the evolution of the initial distribution at time s under the effect of the dynamics.

Then, initially either $\Omega^{(0)}$ vanishes almost everywhere or $\langle \Omega^{(0)} \rangle_t$ initially grows.

Proof. Compute the time-derivative of the ensemble average of $\Omega^{(0)}$ with respect to the ensemble distribution at time s and let the time go to zero:

$$\begin{aligned}
\left. \frac{d}{ds} \langle \Omega^{(0)} \rangle_s \right|_0 &= \lim_{s \rightarrow 0} \frac{1}{s} [\langle \Omega^{(0)} \rangle_s - \langle \Omega^{(0)} \rangle_0] \\
&= \lim_{s \rightarrow 0} \frac{1}{s} \int d\Gamma \Omega^{(0)}(\Gamma) f^{(0)}(\Gamma) \{e^{\Omega_{-s,0}^{(0)}} - 1\} \\
&= \lim_{s \rightarrow 0} \int d\Gamma \Omega^{(0)}(\Gamma) f^{(0)}(\Gamma) \frac{1}{s} \int_{-s}^0 du \Omega^{(0)}(S^u \Gamma) \\
&= \int d\Gamma [\Omega^{(0)}(\Gamma)]^2 f^{(0)}(\Gamma) \geq 0
\end{aligned} \tag{3.22}$$

where equality holds for continuous $\Omega^{(0)}$, only if $\Omega^{(0)}$ vanishes everywhere (except, possibly, on a set of vanishing volume). \square

Recall that $f^{(0)}$ does not vanish anywhere phase space trajectories can go, in order for $\Omega^{(0)}$ to be defined. This condition is also referred in literature as *ergodic consistency* of the initial distribution $f^{(0)}$ with the evolution operator of the dynamics. Assuming that $\Omega_{-t,0}^{(0)}(\Gamma)$ is and remains small up to the desired time t , one may expand (3.21) and obtain the response formula in the linear regime:

$$\begin{aligned}
\langle O \rangle_t - \langle O \rangle_0 &= \int_M O(\Gamma) \Omega(\Gamma)_{-t,0}^{(0)}(\Gamma) f^{(0)}(\Gamma) d\Gamma + \text{higher order terms} \\
&= \langle O \cdot \Omega_{-t,0}^{(0)} \rangle_0 + \text{higher order terms}
\end{aligned} \tag{3.23}$$

which is the Green-Kubo response formula, if $\Omega^{(0)}$ is proportional to the dissipative flux (something that requires $f^{(0)}$ to be the appropriate distribution).

3.2.1 General response: The Dissipation Theorem

In this section derive the *Dissipation Theorem* (DT), whose validity is extremely general since it allows the determination of the ensemble average of a given observable arbitrarily far from equilibrium, [17, 18].

Theorem 3.2.2. (Dissipation Theorem)

Let O be a continuous observable defined on a dynamical system on phase space \mathcal{M} and $\Omega^{(0)}$ the dissipation function (as defined in definition (1)) also continuous operator. Let $\langle O \rangle_t$ converges to $\langle O \rangle_0$ as $t \rightarrow 0$.

Then, under these conditions, we can state that the response of the systems given by:

$$\langle O \rangle_t = \langle O \rangle_0 + \int_0^t ds \langle (O \circ S^s) \cdot \Omega^{(0)} \rangle_0 \quad (3.24)$$

Proof. Differentiating and integrating back Eq.(3.21).

$$\langle O \rangle_t - \langle O \rangle_0 = \int_0^t \frac{d}{ds} [\langle O \rangle_s - \langle O \rangle_0] ds \quad (3.25)$$

To keep track of all necessary conditions, proceed from the definition of derivative:

$$\begin{aligned} \left. \frac{d}{ds} [\langle O \rangle_s - \langle O \rangle_0] \right|_s &= \lim_{h \rightarrow 0} \frac{1}{h} [\langle O \rangle_{s+h} - \langle O \rangle_s] & (3.26) \\ &= \lim_{h \rightarrow 0} \frac{1}{h} \int d\Gamma O(\Gamma) f^{(0)}(\Gamma) \left\{ e^{\Omega_{-s-h,0}^{(0)}(\Gamma)} - e^{\Omega_{-s,0}^{(0)}(\Gamma)} \right\} \\ &= \lim_{h \rightarrow 0} \frac{1}{h} \int d\Gamma O(\Gamma) f^{(0)}(\Gamma) e^{\Omega_{-s,0}^{(0)}(\Gamma)} \left\{ e^{\Omega_{-s-h,-s}^{(0)}(\Gamma)} - 1 \right\} \end{aligned}$$

If $\Omega^{(0)}$ is continuous, one has the following:

$$\lim_{h \rightarrow 0} \frac{1}{h} \left\{ e^{\Omega_{-s-h,0}^{(0)}(\Gamma)} - e^{\Omega_{-s,0}^{(0)}(\Gamma)} \right\} = \lim_{h \rightarrow 0} \frac{1}{h} \Omega_{-s-h,-s}^{(0)}(\Gamma) \quad (3.27)$$

$$= \lim_{h \rightarrow 0} \frac{1}{h} \int_{-s-h}^{-s} \Omega^{(0)}(S^u \Gamma) du = \Omega^{(0)}(S^{-s} \Gamma) \quad (3.28)$$

Therefore substituting in Eq.(3.26), one obtains:

$$\langle O \rangle_t - \langle O \rangle_0 = \int_0^t \frac{d}{ds} [\langle O \rangle_s - \langle O \rangle_0] ds = \int_0^t ds \int_M O(\Gamma) \Omega^{(0)}(S^{-s} \Gamma) e^{\Omega_{-s,0}^{(0)}(\Gamma)} f^{(0)}(\Gamma) d\Gamma \quad (3.29)$$

Change coordinates: let $X = S^{-s}\Gamma$ i.e. $\Gamma = S^s X$. whose Jacobian determinant is given by:

$$\left| \frac{d\Gamma}{dX} \right| = e^{\int_0^s \Lambda(s^u X) du} = e^{\Lambda_{0,s}(X)} \quad (3.30)$$

Then,

$$\begin{aligned} & \int_M O(\Gamma) \Omega^{(0)}(S^{-s}\Gamma) e^{\Omega_{-s,0}^{(0)}(\Gamma)} f^{(0)}(\Gamma) d\Gamma \\ &= \int_M O(S^s X) \Omega^{(0)}(X) e^{\Omega_{-s,0}^{(0)}(S^s X)} e^{\Lambda_{0,s}(X)} f^{(0)}(S^s X) dX \end{aligned} \quad (3.31)$$

Letting $z = u + s$ so that $dz = du$, one has :

$$\Omega_{-s,0}^{(0)}(S^s X) = \int_{-s}^0 \Omega^{(0)}(S^{u+s} X) du = \int_0^s \Omega(S^z X) dz = \Omega_{0,s}^{(0)}(X) \quad (3.32)$$

therefore:

$$\begin{aligned} & \int_M O(S^s X) \Omega^{(0)}(X) e^{\Omega_{-s,0}^{(0)}(S^s X)} e^{\Lambda_{0,s}(X)} f^{(0)}(S^s X) dX \\ &= \int_M O(S^s X) \Omega^{(0)}(X) e^{\Omega_{0,s}^{(0)}(X)} e^{\Lambda_{0,s}(X)} f^{(0)}(S^s X) dX \end{aligned} \quad (3.33)$$

The definition of $\Omega_{0,s}^{(0)}$ yields

$$e^{\Omega_{0,s}^{(0)}(X)} e^{\Lambda_{0,s}(X)} f^{(0)}(X) = \frac{f^{(0)}(X)}{f^{(0)}(S^s X)} \quad (3.34)$$

hence one can write:

$$\begin{aligned} \langle O \rangle_t - \langle O \rangle_0 &= \int_0^t ds \int_M O(\Gamma) \Omega^{(0)}(S^{-s}\Gamma) e^{\Omega_{-s,0}^{(0)}(\Gamma)} f^{(0)}(\Gamma) \\ &= \int_0^t ds \int_M O(S^s \Gamma) \Omega^{(0)}(\Gamma) f^{(0)}(\Gamma) d\Gamma \\ &= \int_0^t ds \int_M [(O \circ S^s)(\Gamma) \cdot \Omega^{(0)}(\Gamma)] f^{(0)}(\Gamma) d\Gamma \\ &= \int_0^t ds \langle (O \circ S^s) \cdot \Omega^{(0)} \rangle_0 \end{aligned} \quad (3.35)$$

which proves the statement in (3.24) □

3.2.2 Consistency conditions of DT

The easiest observable of all is the constant (in phase space) function. In particular $O(\Gamma) = 1$ for all $\Gamma \in M$ is of interest, since its average is the normalization constant of the probability distribution:

$$\langle 1 \rangle = \int_M 1 \cdot f(\Gamma) d\Gamma = 1 \quad (3.36)$$

Therefore, one should have:

$$1 = \langle 1 \rangle_t = \langle 1 \rangle_0 + \int_M ds \langle 1 \cdot \Omega^{(0)} \rangle_0 = 1 + \langle \Omega^{(0)} \rangle_0 t \quad (3.37)$$

which is all right because $\langle \Omega^{(0)} \rangle_0 = 0$.

3.3 t-mixing and convergence to steady state

The correlations decay of Eq.(1.64) is one special case of a notion which could be formalized as follows:

$$\lim_{t \rightarrow \infty} [\langle \psi(\phi \circ S^t) \rangle_0 - \langle \psi \rangle_0 \langle \phi \rangle_t] = 0 \quad (3.38)$$

Consider the particular case in which $\psi = \Omega$. The fact that $\langle \Omega \rangle_0 = 0$, because Ω is odd and f_0 is even under time reversal, reduces Eq.(3.38) to the simpler expression

$$\lim_{t \rightarrow \infty} \langle \Omega(\phi \circ S^t) \rangle_0 = 0 \quad (3.39)$$

We now introduce the useful notion of the t-mixing condition as expressed by the following

Definition 2. given the dynamical system $\dot{\Gamma} = G(\Gamma)$ defined on a phase space \mathcal{M} , let O be a continuous observable operator defined on \mathcal{M} and $\Omega^{(0)}$ be the dissipation defined as in definition (1) .

If the following condition holds:

$$\int_0^t ds \langle (O \circ S^s) \cdot \Omega^{(0)} \rangle_0 \rightarrow \int_0^\infty ds \langle (O \circ S^s) \cdot \Omega^{(0)} \rangle_0 = L_0 \quad (3.40)$$

as $t \rightarrow \infty$, where L_0 is a real number, we say that the dynamics is *t-mixing*.

Corollary 3.3.1. (Corollary to the Dissipation Theorem)

If a dynamical system is *t-mixing*, then it converges to a steady state.

Proof. Suppose the system be *t-mixing*, then from the definition it requires

$$\langle (O \circ S^s) \cdot \Omega^{(0)} \rangle_0 \rightarrow 0 \quad (3.41)$$

faster than $O(1/t)$. From the DT, this condition immediately implies:

$$\langle O \rangle_t = \langle O \rangle_0 + \int_0^t ds \langle (O \cdot \Omega^{(0)}) \rangle_0 \rightarrow \langle O \rangle_0 + L_0 \quad (3.42)$$

for $t \rightarrow \infty$, which proves the convergence to a steady state, if (3.40) is assumed to hold for all observables. \square

This proof, as simple as the one based on the standard mixing for convergence to the microcanonical ensemble, is more general, as it holds for dissipative systems as well. The *t-mixing* implies the convergence to a steady state, whereas the standard mixing, in general, does not. More precisely, the latter assumes with respect to an invariant probability measure that the (macro-)state is already stationary, making irrelevant the problem of convergence to a steady state.

To know which steady state is eventually reached, it requires the knowledge of the dynamics, since different dynamics will converge to different steady states. Therefore, the general proof cannot go beyond this step. However, one may investigate the question of the uniqueness of the steady state reached starting from different initial states.

Let us consider first two cases with different initial distributions, $f^{(0)}$ and $g^{(0)}$ with $\langle \Omega^{(f)} \rangle_{f^{(0)}}$ and $\langle \Omega^{(g)} \rangle_{g^{(0)}}$ where $\langle O \rangle_*$ is the average of the observable O with respect to the initial distribution $*$, and the dissipation function Ω^* is obtained from the $*$ initial distribution, i.e. $f^{(0)}$ or $g^{(0)}$. The two distributions could be completely independent, but could also be successive distributions with same initial condition.

In order for the steady state to be the same, one needs:

$$\langle O \rangle_{f^{(0)}} + \int_0^t ds \langle (O \circ S^s) \cdot \Omega^{(f)} \rangle_{f^{(0)}} - \langle O \rangle_{g^{(0)}} + \int_0^t ds \langle (O \circ S^s) \cdot \Omega^{(g)} \rangle_{g^{(0)}} \xrightarrow{t \rightarrow \infty} 0 \quad (3.43)$$

i.e.

$$\int_0^\infty ds [\langle (O \circ S^s) \cdot \Omega^{(f)} \rangle_{f^{(0)}} - \langle (O \circ S^s) \cdot \Omega^{(g)} \rangle_{g^{(0)}}] = \langle O \rangle_{g^{(0)}} - \langle O \rangle_{f^{(0)}} \quad (3.44)$$

One knows that the integral on the right hand side equals a constant, if the t-mixing condition is satisfied with respect to both the initial distributions. But let us consider simple specific cases, first. If the dynamics are phase space volume preserving, then starting from a probability density, at any finite time we may only have probability densities and the same holds asymptotically in time. Furthermore, if one adds the ergodic hypothesis, then there is only one invariant probability density. This implies that all converging evolutions, i.e. evolutions obeying t-mixing will converge to the

same stationary and non dissipative state. But which ergodic hypothesis are we considering? Ergodicity with respect to the asymptotic steady state.

Are we assuming too much? Is ergodicity (of the final state) plus t-mixing a stronger condition than standard mixing?

In the first place, one thing we should be aware of, is that standard mixing proof for convergence to the microcanonical ensemble can be adjusted to yield convergence to other invariant states which have a stationary probability density, for phase space volume preserving dynamics.

To see that, assume (standard) mixing with respect to an invariant distribution of density h , which means:

$$\begin{aligned} \int A(S^t\Gamma)B(\Gamma)h(\Gamma)d\Gamma &= \\ \langle (A \circ S^t) \cdot B \rangle_h &\rightarrow \langle A \rangle_h \langle B \rangle_h \\ &= \int A(\Gamma)h(\Gamma)d\Gamma \cdot \int B(\Gamma)h(\Gamma)d\Gamma \end{aligned} \quad (3.45)$$

Notice that, in order to have an invariant density, phase space volumes must be preserved on average by the dynamics.

For any time dependent distribution $f^{(t)}$, introduce $C^{(t)}$ as :

$$C^{(t)}(\cdot) = \frac{f^{(t)}(\cdot)}{h(\cdot)}; \quad f^{(t)}(\cdot) = C^{(t)}(\cdot)h(\cdot) \quad (3.46)$$

which leads to the following property:

$$\begin{aligned} \int C^{(t)}(\Gamma)h(\Gamma)d\Gamma &= \int f^{(t)}(\Gamma)d\Gamma = 1 \\ \int \frac{1}{C^{(t)}(\Gamma)}f^{(t)}(\Gamma)d\Gamma &= \int h(\Gamma)d\Gamma = 1 \end{aligned} \quad (3.47)$$

for all times. Then, consider the evolving observable

$$\langle A \rangle_t = \int A(\Gamma)f^{(t)}(\Gamma)d\Gamma = \int A(\Gamma)C^{(t)}(\Gamma)h(\Gamma) = \langle AC^{(t)}(\cdot) \rangle_h \quad (3.48)$$

For phase space volume preserving dynamics, one has :

$$\langle A \rangle_t = \int A(\Gamma) f^{(t)}(\Gamma) d\Gamma = \int A(\Gamma) f^{(0)}(S^{-t}\Gamma) d\Gamma \quad (3.49)$$

which means

$$\int A(\Gamma) f^{(0)}(S^{-t}\Gamma) d\Gamma = \int A(\Gamma) C^{(0)}(S^{-t}\Gamma) h(\Gamma) d\Gamma \quad (3.50)$$

by definition of C . Now, the coordinate change $X = S^{-t}\Gamma$, i.e. $\Gamma = S^t X$, together with phase space volume preservation and stationary h , yield:

$$\begin{aligned} \langle A \rangle_t &= \int A(\Gamma) C^{(0)}(S^{-t}\Gamma) h(\Gamma) d\Gamma = \int A(\Gamma) C^{(0)}(\Gamma) h(S^t\Gamma) d\Gamma \\ &= \int A(S^t\Gamma) C^{(0)}(\Gamma) h(\Gamma) d\Gamma \end{aligned} \quad (3.51)$$

and then the standard mixing produces convergence to the steady state of density h :

$$\langle A \rangle_t = \int A(S^t\Gamma) C^{(0)}(\Gamma) h(\Gamma) d\Gamma = \langle A \circ S^t \cdot C^{(0)}(\cdot) \rangle_h = \langle A \rangle_h \langle C^{(0)} \rangle_h = \langle A \rangle_h \quad (3.52)$$

Because standard mixing implies ergodicity of the steady state, this proof does not require the further assumption of ergodicity and seems similar to the combined assumption t -mixing + ergodicity. Of course care must be taken because many physical situations contradict the mixing assumptions. In extreme synthesis, all the above is due to the fact that being mixing with respect to a regular measure or another makes little difference. Densities, if they are stationary, represent some kind of equilibrium and mixing with respect to them implies convergence to them.

If dynamics are dissipative (in the sense of phase space volume contraction), the steady state is singular, and it is less obvious that the steady state to which different initial states converge is unique. In particular, the derivation based on the

stationary density does not apply. Here, it seems that t-mixing takes us one step ahead, the question is about the uniqueness of the steady state. But one could say that the derivation is exact, hence if uniqueness is lacking, then it is because the physical situation at hand has no unique steady state. So lack of uniqueness is the right thing. It may then be interesting to find which conditions lead to uniqueness in the dissipative case.

3.4 t-mixing as correlation decay

Consider the time correlation function of two observables A and B , with respect to a given probability measure μ :

$$\begin{aligned} \int_M [A(S^s X) - \langle A \rangle_\mu] \cdot [B(X) - \langle B \rangle_\mu] d\mu &= \langle (A - \langle A \rangle_\mu) \circ S^s \cdot (B - \langle B \rangle_\mu) \rangle_\mu = \\ \langle (A \circ S^s) \cdot B \rangle_\mu - \langle A \circ S^s \rangle_\mu \langle B \rangle_\mu - \langle A \rangle_\mu \langle B \rangle_\mu + \langle A \rangle_\mu \langle B \rangle_\mu &= \\ \langle (A \circ S^s) \cdot B \rangle_\mu - \langle A \rangle_\mu \langle B \rangle_\mu & \end{aligned} \tag{3.53}$$

which tends to zero if correlations with respect to μ decay in time. In that case one obtains:

$$\langle (A \circ S^t) \cdot B \rangle_\mu \rightarrow_{t \rightarrow \infty} \langle A \rangle_\mu \langle B \rangle_\mu \tag{3.54}$$

What if μ is the initial distribution? One would have :

$$\langle (A \circ S^t) \cdot B \rangle_0 \rightarrow_{t \rightarrow \infty} \langle A \rangle_0 \langle B \rangle_0 \tag{3.55}$$

and in particular:

$$\langle (A \circ S^t) \cdot \Omega^{(0)} \rangle_0 \rightarrow_{t \rightarrow \infty} \langle A \rangle_0 \langle \Omega^{(0)} \rangle_0 \tag{3.56}$$

which is necessary to converge to a steady state, i.e. for the following integrals to converge:

$$\langle A \rangle_t = \langle A \rangle_0 + \int_0^t ds \int A(S^s \Gamma) \Omega^{(0)}(\Gamma) f^{(0)}(\Gamma) d\Gamma \quad (3.57)$$

But one may consider different kinds of t-mixing. Indeed the form required in the derivation of the steady state fluctuation relation is the following:

$$\langle (A \circ S^t) \cdot B \rangle_0 \rightarrow_{t \rightarrow \infty} \langle A \rangle_\infty \langle B \rangle_0 \quad (3.58)$$

from which convergence of (3.57) may still follow, because one has

$$\langle (A \circ S^t) \cdot \Omega^{(0)} \rangle_0 \rightarrow_{t \rightarrow \infty} \langle A \rangle_\infty \langle \Omega^{(0)} \rangle_0 \quad (3.59)$$

while the following form does not guarantee that:

$$\langle (A \circ S^t) \cdot B \rangle_0 \rightarrow_{t \rightarrow \infty} \langle A \rangle_\infty \langle B \rangle_\infty \quad (3.60)$$

3.5 Time evolution of the different Dissipation Functions

Unless $\Omega^{(0)}$ vanishes almost everywhere, one has :

$$\left. \frac{d}{ds} \langle \Omega^{(0)} \rangle_s \right|_{s=0} > 0 \quad (3.61)$$

as shown by (3.22), hence $\langle \Omega^{(0)} \rangle_t > 0$ at least for small times (i.e. $\exists \epsilon > 0$ such that $\langle \Omega^{(0)} \rangle_t > 0$ if $0 < t < \epsilon$). Suppose a steady state is reached. This means that:

$$\lim_{t \rightarrow \infty} \langle \Omega^{(0)} \rangle_t = \langle \Omega^{(0)} \rangle_\infty \quad ; \quad \lim_{t \rightarrow \infty} \left. \frac{d}{ds} \langle \Omega^{(0)} \rangle_s \right|_{s=0} = 0 \quad (3.62)$$

what value is taken by $\langle \Omega^{(0)} \rangle_\infty$? This question cannot be answered only on the above grounds. Therefore, let us look at some specific case.

- 1. Let the dynamics be phase space volumes preserving; then, starting from an initial density, one will evolve through probability distributions which have a density.
- 2. Let the dynamics be t-mixing; then, evolutions tends to a steady state. Because of 1. This steady state has a density, $f^{(\infty)}$ say.
- 3. If the dynamics are transitive in the ostensible phase space, then this density is microcanonical.

More generally, suppose we have an invariant density $f^{(\infty)}$ as our current state, which supposes that volumes are preserved on average along each trajectory, but are not necessarily constant. We can take $f^{(\infty)}$ steady state as the initial one state:

$$g^{(0)}(\Gamma) = f^{(\infty)}(\Gamma) \quad (3.63)$$

and then we can introduce a new dissipation function $\Omega^{(g,0)}$, say, whose integral between time 0 and s is given by

$$\Omega_{0,s}^{(g,0)}(\Gamma) = \int_0^s \Omega^{(g,0)}(S^u\Gamma) du = \ln \frac{g^{(0)}(\Gamma)}{g^{(0)}(iS^s\Gamma)} - \Lambda_{0,s}(\Gamma) \quad (3.64)$$

Because we are in a steady state, the averages of $\Omega^{(g,0)}$ at any time obey:

$$\langle \Omega^{(g,0)} \rangle_t = \int_M \Omega^{(g,0)}(\Gamma) g^{(t)} d\Gamma = \langle \Omega^{(g,0)} \rangle_0 = \int_M \Omega^{(g,0)}(\Gamma) f^{(\infty)}(\Gamma) d\Gamma \quad (3.65)$$

and

$$\frac{d}{ds} \langle \Omega^{(g,0)} \rangle_s \Big|_{s=t} = 0 \quad (3.66)$$

In particular we also have that

$$\frac{d}{ds} \langle \Omega^{(g,0)} \rangle_s \Big|_{s=0} = \int d\Gamma [\Omega^{(g,0)}(\Gamma)]^2 g^{(0)}(\Gamma) = 0 \quad (3.67)$$

which implies that $\Omega^{(g,0)}$ vanishes almost everywhere $g^{(0)}(\Gamma)$ is positive.

Since, by definition, $\Omega^{(g,0)} = 0$ implies $g^{(0)}(\Gamma)$ be the equilibrium distribution, this proves that, in non dissipative transitive dynamics, the steady state correspond to the equilibrium state.

It is interesting to observe that $\langle \Omega^{(g,0)} \rangle_0$ does not need to equal

$$\langle \Omega^{(0)} \rangle_\infty = \int d\Gamma f^{(\infty)}(\Gamma) \Omega^{(0)}(\Gamma)$$

although both are constant in time. Knowing from t-mixing that the system converges to a steady state, can one infer its form, e.g. from the initial condition $f^{(0)}$? That does not look immediately possible, because phase space volumes preserving dynamics do not need to be transitive, hence ergodic. If they are not, volumes will be preserved, but may remain confined forever within a subspace of the phase space. Moreover, fluctuating volumes, even with no mean compression, make not obvious that the initial density converges to another asymptotic density. Indeed, the probability contained in a given volume could be squeezed within a vanishing volume while that contained in another volume takes its place. The overall occupied volume is the same, but the distribution is now singular. Then, it is a matter of how one computes the average of the divergence of the equations of motion, in order to obtain one value or another. Indeed, computing this average with respect to the initial distribution may yield a value which differs from the one computed with respect to the stationary measure.

Another observation is that one may always write the relaxation process as:

$$f^{(t)}(\Gamma) = C^{(t)}(\Gamma) f^{(0)}(\Gamma) \tag{3.68}$$

but the function $C^{(t)}(\Gamma)$ cannot be expressed as

$$C^{(t)}(\Gamma) = \gamma(t)g(\Gamma) \tag{3.69}$$

where $g(\Gamma)$ is even with respect to time reversal (having assumed that $f^{(0)}(\Gamma)$ is). Indeed, if $g(\Gamma)$ was even respect to time reversal, then also $f^{(t)}(\Gamma)$ would be, and $\langle \Omega^{(0)} \rangle_t$ would vanish at all times, rather than being positive at least for small times.

3.6 Conclusions

In non-dissipative ergodic reversible dynamical systems, *t-mixing* guarantees the convergence to a stationary state. We have shown that if such stationary distribution exists, it yields to a corresponding Ω dissipation function which is null almost everywhere in the defined phase space. We remark that the dissipation function is null just in case, in the definition, we employed the equilibrium distribution. In these hypothesis this proofs, starting from an initial distribution even respect time-reversal mapping, the convergence to the equilibrium state: in case of hamiltonian systems it will lead to the microcanonical distribution either it will lead to the canonical in case of non-hamiltonian thermostatted dynamics.

Chapter 4

Molecular Dynamics

We present the results of MD simulations performed for a Lennard-Jones interacting particle-system subject to a thermal gradient kept in a non-equilibrium steady state. We underline the achievement of stable non-equilibrium configuration in our MD simulations. In our work we propose and discuss a new definition for observables virtually representing the longitudinal dimension of a microscopic object given by the condensation of few thousands molecules, obtained through an annealing-inspired method. We verify, in the steady state, an extended FR for such observable according to the large deviation theory approach.

4.1 Fluctuation Analysis in AURIGA gravitational antenna

In this section, we describe the study performed on the basis of Molecular Dynamics simulations (MD) which took its inspiration by the experimental project AURIGA

on the detection of gravitational waves, carried at the LNL- Laboratori Nazionali di Legnaro.

General Relativity theory predicts the existence of gravitational waves (GW) which are perturbations of the gravitational field spread out at the speed of light, generated by the motion and variations of masses of celestial bodies. GW distort space time and produces forces in such a way that the distances will alternatively decrease and increase during the passage of a GW. On these basis, the AURIGA gravitational antenna was built: it is basically composed by a 2.2 tons bar made in low-loss aluminium alloy cooled to liquid helium temperature (4.6 K). In the experimental equipment, the bar resonator motion is detected by a capacity transducer: to improve the efficiency of the gravitational waves detection, cold damping feedback can reduce noise given by the intrinsic fluctuations. The apparatus, which is maintained in a Non Equilibrium Steady State (NESS) by an external driving in a feedback cooling scheme (which behaves as a viscous force), can be modeled basically as a electromechanical oscillator forced by a stochastic driving. In reference [32] the authors present the results of the analysis on fluctuations of the absorbed heat [3], which in fact maintain the dissipative system in a steady state, and verify the Fluctuation Relation [40] (which generally holds in nonequilibrium systems).

In our MD simulations we aim to reproduce a stable nonequilibrium system of particles in steady state by applying a thermal gradient between the two edges of the 'solid' bar, which is constituted by the condensation of nearly ten thousands molecules kept at very low temperatures.

We list our purposes in the following:

- first, we aim to identify a proper definition of length (which represents quite subtle task in a microscopic object made of few thousands molecules as in our model)
- develop an advantageous procedure for MD simulations inspired to the annealing process in order to relax in affordable computational time the system to the equilibrium steady state at very low temperatures
- perform fluctuation analysis to put in evidence which kind of Fluctuation Relation is deducible from the asymmetries generated by the heat flux.

4.2 General set-up

Here we summarize the salient features of the MD simulation code. It basically simulates a Lennard-Jones interacting particles thermostatted system, which is driven out of thermal equilibrium. The code has been developed by dr. Ding Yi, post-doc researcher at the ETH, Polytechnic school of Zurich.

4.2.1 The spatial settings

In order to simulate bulk phases it is essential to choose boundary conditions that simulate the presence of an infinite bulk surrounding the N-particle system. The volume containing the N-particles is treated as it would be one of infinite identical cells which surround the simulating box, so that, in principle, we may assume that every particle interacts with all the particles of an infinite solid. The particles interact on the basis of a Lennard-Jones interatomic potential, expressed in reduced

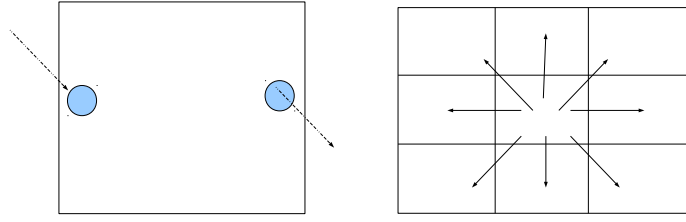

Figure 4.1: Left panel: a schematic description of the functioning of a periodic box. On the right: Scheme of the cell-list method. The particles may interact just within the particles in the same box or in the neighbouring.

units:

$$U(r) = 4 \left[\left(\frac{1}{r} \right)^{12} - \left(\frac{1}{r} \right)^6 \right] \quad (4.1)$$

where r is the interatomic distance (see figure 4.2).

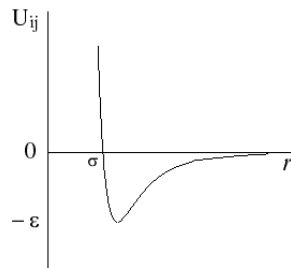

Figure 4.2: The Lennard-Jones interatomic potential.

To truncate the potential range, in order to optimize the computation, we set a cut-off distance at $r_c = 2.5$, in order to ignore the tail contribution of the potential. The simulation box is divided into cells of size $r_c \times r_c$, such that every particle in the cell interacts with only those particles belonging to the same or in the neighbouring cells.

The algorithm described above is commonly known as "Cell-list structure".

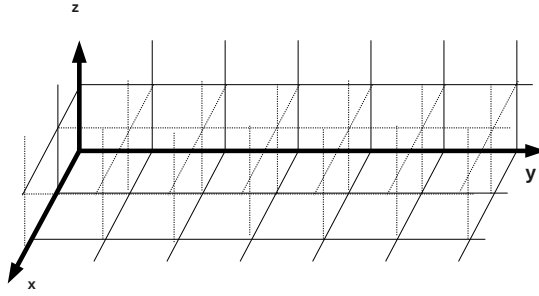

Figure 4.3: The division in cells of the simulating box.

4.2.2 The thermostating system

In the MD code, the thermal control of the system along the y -axis is introduced by thermostating each cell in sequence by independent Nose' Hoover (NH) thermostats.

The mechanism of the NH thermostats is based on an extended Lagrangian which contains artificial coordinates and velocities: by the introduction of an additional coordinate s in the Lagrangian of a classical N -body system, we may perform isothermal dynamical simulations. More explicitly:

$$\mathcal{L}_{Nose} = \sum_{i=1}^N \frac{m_i}{2} s^2 \dot{r}_i^2 - U(r^N) + \frac{Q}{2} \dot{s}^2 - \frac{L}{\beta} \log s \quad (4.2)$$

where $\beta = \frac{1}{kT}$ and Q is an effective mass associated to s and

$$\begin{aligned} p_i &:= \frac{\partial \mathcal{L}}{\partial \dot{r}_i} = m_i s^2 \dot{r}_i \\ p_s &:= \frac{\partial \mathcal{L}}{\partial \dot{s}} = Q \dot{s} \end{aligned}$$

The corresponding Nose'-Hoover Hamiltonian is given by:

$$\mathcal{H}_{Nose} = \sum_{i=1}^N \frac{p_i^2}{2m_i s^2} + U(r^N) + \frac{Q}{2} \dot{s}^2 - \frac{p_s^2}{2Q} + \frac{L \log s}{\beta} \quad (4.3)$$

The effect given by the Nose-Hoover thermostating algorithm is explicitly shown in the resulting equations of motion

$$\dot{r}_i = \frac{p_i}{m_i} \quad (4.4)$$

$$\dot{p}_i = -\frac{\partial U(r^N)}{\partial r_i} - \xi p_i \quad (4.5)$$

$$\dot{\xi} = \left(\sum_i \frac{p_i^2}{m_i} - \frac{L}{\beta} \right) \quad (4.6)$$

$$\frac{\dot{s}}{s} = \frac{d \log s}{dt} = \xi \quad (4.7)$$

$$(4.8)$$

where ξ plays the role of a friction coefficient rescaling the velocities in order to hold (globally) the isokinetical condition, approximating the correct Maxwell-Boltzmann velocity distribution. Here, a small value of Q corresponds to a low inertia of the heat bath and leads to rapid temperature response to a temperature jump.

In our model we may choose whether thermostat or not the cells in the y -axis. Whenever a cell is not thermostatted the dynamics is hamiltonian. It is not appropriate to thermostat two consecutive cells at different temperatures: on the contrary, leaving one unthermostatted cell in between will guarantee to obtain a linear gradient for the kinetical temperature profile.

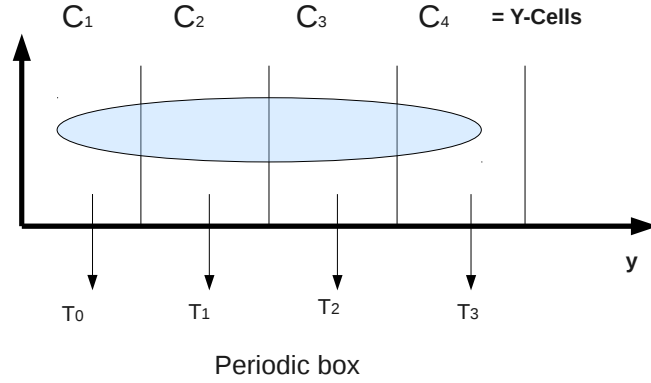

Figure 4.4: Scheme of the sequence of the Nose-Hoover Thermostats along the longitudinal direction of the simulating box.

4.3 The dynamics: the Verlet algorithm

In this section we describe the Verlet algorithm which was used to implement the equations of motion. This algorithm is commonly recognized as one of the simplest and the most efficient in optimizing the computational time. In the following, we give a basic description.

Let us start with a Taylor expansion of the particle position around time t :

$$r(t + \Delta t) = r(t) + v(t)\Delta t + \frac{f(t)}{2m}\Delta t^2 + \frac{\Delta t^3}{3!}\frac{\partial^3 r}{\partial t^3} + O(\Delta^4) \quad (4.9)$$

where $f(t)$ is the force according to the interatomic Lennard Jones potential.

Similarly we can write:

$$r(t - \Delta t) = r(t) - v(t)\Delta t + \frac{f(t)}{2m}\Delta t^2 - \frac{\Delta t^3}{3!}\frac{\partial^3 r}{\partial t^3} + O(\Delta^4) \quad (4.10)$$

Summing these two equations together we easily obtain:

$$r(t + \Delta t) \approx 2r(t) - r(t - \Delta t) + \frac{f(t)}{2}\Delta t^2 \quad (4.11)$$

with an error of the order of $O(\Delta t^4)$, where Δt is the timestep defined in MD.

Thus we compute the velocity $v(t)$ from the knowledge of the trajectory by the following relation:

$$r(t + \Delta t) - r(t - \Delta t) = 2v(t)\Delta t + O(\Delta^4) \quad (4.12)$$

which leads to the explicit expression

$$v(t) = \frac{r(t + \Delta t) - r(t - \Delta t)}{2\Delta t} + O(\Delta^2) \quad (4.13)$$

with an accuracy of the order of $O(\Delta t^2)$.

4.4 Observable definition: the system lenght

The system under analysis is composed of 9216 Lennard-Jones interacting particles placed in a simulation box constituted by $8 \times 42 \times 8$ computational macrocells (each measuring $r_c = 2.5$ in reduced units) kinetically-thermal constrained by a sequence of Nose' Hoover thermostats on the y -axis.

In order to start a quantitative study of fluctuations of the lenght of the solid bar, we need first to reach a steady state (achieved through the annealing-like procedure described in the next section).

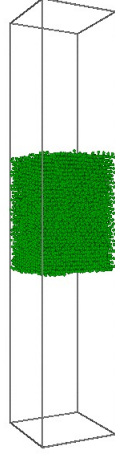

Figure 4.5: A picture of the molecular system at equilibrium.

4.4.1 The annealing procedure

To obtain flat profile densities, we adopted a quite simple method inspired at the annealing procedure.

Supposing to choose a target temperature T_{targ} to perform the measurements for a cristallized object, we initially set at time $t = t_1$ the thermostats at the temperature $T_{1border}$ at the edges of the box and at temperature T_1 in the center such that $T_{1border} \gg T_1 > T_{targ}$. As the system relax, slowly (for $\Delta t = 5 \cdot 10^4$ timesteps) we cool the system down: at time $t = t_2$, we set the temperature to $T_{2border} < T_{1border}$ and $T_2 < T_1$. Reiterating this procedure until T_{targ} is reached, the system slowly "freeze" relaxing and reducing irregularities in the density profile. At the end of the procedure we restore the temperature along all the box at thermal equilibrium condition.

We set the temperature profile with higher temperature at the edges because, in

this fashion, we can reduce the relaxation time "trapping" the particles in the centre of the box while they are still in liquid configuration. Indeed, the colder temperature in the middle of the simulating box, rapidly slow down the particles and keep them together.

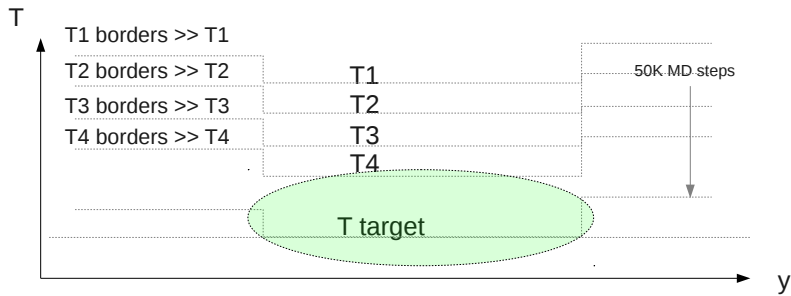

Figure 4.6: The annealing procedure scheme.

4.4.2 The equilibrium case

The first tests were performed on equilibrium systems. Pictures 4.7 show a sample of the stability conditions required in our simulations: the system kept at constant temperature by the thermostats (left panel) confirms that, for times of the order 10^6 time-steps (sampling every 10^2 time-steps, with time-step $\Delta t = 0.005$), particles do not evaporate. Furthermore, monitoring the density profile along the thermostatted y -axis in time (right panel), we may verify that particles are effectively populating an equilibrium configuration, which is a necessary condition to test different observ-

able definitions for the the spatial length of the system.

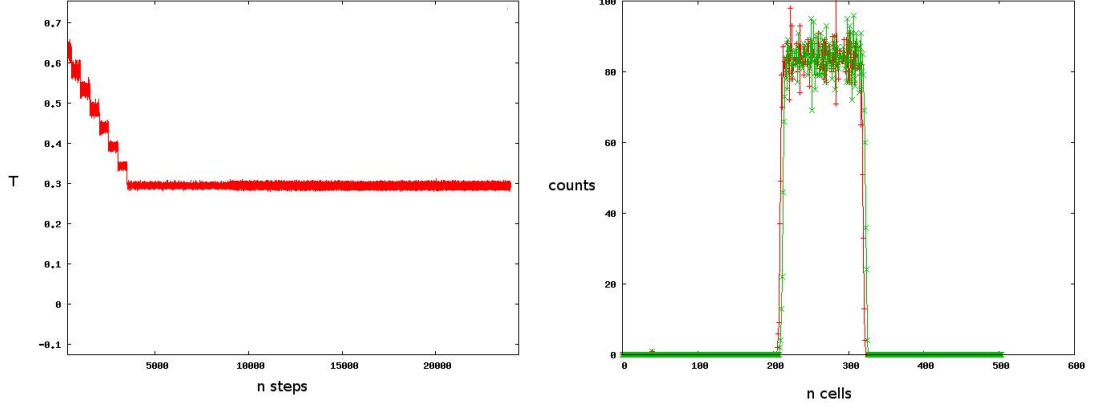

Figure 4.7: *Left panel:* the kinetical temperature profile (y -axis) for the equilibrium case along the simultaion time (x -axis, data are sampled every 10^2). The temperature is set to the target value of $T=0.3$ (in reduced units) by Nose' Hoover thermostats. In the plot, on the left, it can be recognized the annealing procedure used to reach the target value. *Right panel:* Density profiles taken at different times in the steady state regime. Comparing denisties in the y -axis direction with an interval of 10^5 timesteps, the profiles do not change significantly, suggesting that a steady state has got reached.

In the following, four different definition of length based on the gradient of the density $n(y)$ are proposed and tested. In particular:

- 'end to end' distance - definition-1.

$$L_1 = \frac{\int_0^{L/2} y \nabla n(y) dy}{\int_0^{L/2} \nabla n(y) dy} - \frac{\int_{L/2}^L y \nabla n(y) dy}{\int_{L/2}^L \nabla n(y) dy} \quad (4.14)$$

- 'end to end' distance - definition-2.

$$L_2 = \frac{\int_0^{L/2} y [\nabla n(y)]^2 dy}{\int_0^{L/2} [\nabla n(y)]^2 dy} - \frac{\int_{L/2}^L y [\nabla n(y)]^2 dy}{\int_{L/2}^L [\nabla n(y)]^2 dy} \quad (4.15)$$

- 'end to end' distance - definition-3.

$$L_3 = \frac{\int_0^{L/2} y[\nabla n(y)]^3 dy}{\int_0^{L/2} [\nabla n(y)]^3 dy} - \frac{\int_{L/2}^L y[\nabla n(y)]^3 dy}{\int_{L/2}^L [\nabla n(y)]^3 dy} \quad (4.16)$$

- 'end to end' distance - definition-4.

$$L_4 = \frac{\int_0^{L/2} y[\nabla n(y)]^4 dy}{\int_0^{L/2} [\nabla n(y)]^4 dy} - \frac{\int_{L/2}^L y[\nabla n(y)]^4 dy}{\int_{L/2}^L [\nabla n(y)]^4 dy} \quad (4.17)$$

where L is the length of the simulating box in the y direction. As the gradient $\nabla n(y)$ it is computed on the basis of the discretization of space in cells, it has been necessary splitting each cell in subcells (which have a size of a factor 12 times smaller than the macrocell used in the dynamical computation) in order to refine the determination of distances.

In discrete terms, making use of the "forward difference" method to calculate the gradients, the four definitions become:

- discretized 'end to end' distance - definition-1.

$$L_1 = \frac{\sum_{i=1}^{N_{cells}/2} \Delta y \left[\frac{N_{i+1} - N_{i-1}}{2} \right]}{\sum_{i=1}^{N_{cells}/2} \left[\frac{N_{i+1} - N_{i-1}}{2} \right]} - \frac{\sum_{i=N_{cells}/2+1}^{N_{cells}} \Delta y \left[\frac{N_{i+1} - N_{i-1}}{2} \right]}{\sum_{i=N_{cells}/2+1}^{N_{cells}} \left[\frac{N_{i+1} - N_{i-1}}{2} \right]} \quad (4.18)$$

- discretized 'end to end' distance - definition-2.

$$L_2 = \frac{\sum_{i=1}^{N_{cells}/2} \Delta y \left[\frac{N_{i+1} - N_{i-1}}{2} \right]^2}{\sum_{i=1}^{N_{cells}/2} \left[\frac{N_{i+1} - N_{i-1}}{2} \right]^2} - \frac{\sum_{i=N_{cells}/2+1}^{N_{cells}} \Delta y \left[\frac{N_{i+1} - N_{i-1}}{2} \right]^2}{\sum_{i=N_{cells}/2+1}^{N_{cells}} \left[\frac{N_{i+1} - N_{i-1}}{2} \right]^2} \quad (4.19)$$

- discretized 'end to end' distance - definition-3.

$$L_3 = \frac{\sum_{i=1}^{N_{cells}/2} \Delta y \left[\frac{N_{i+1} - N_{i-1}}{2} \right]^3}{\sum_{i=1}^{N_{cells}/2} \left[\frac{N_{i+1} - N_{i-1}}{2} \right]^3} - \frac{\sum_{i=N_{cells}/2+1}^{N_{cells}} \Delta y \left[\frac{N_{i+1} - N_{i-1}}{2} \right]^3}{\sum_{i=N_{cells}/2+1}^{N_{cells}} \left[\frac{N_{i+1} - N_{i-1}}{2} \right]^3} \quad (4.20)$$

- discretized 'end to end' distance - definition-4.

$$L_4 = \frac{\sum_{i=1}^{N_{cells}/2} \Delta y \left[\frac{N_{i+1} - N_{i-1}}{2} \right]^4}{\sum_{i=1}^{N_{cells}/2} \left[\frac{N_{i+1} - N_{i-1}}{2} \right]^4} - \frac{\sum_{i=N_{cells}/2+1}^{N_{cells}} \Delta y \left[\frac{N_{i+1} - N_{i-1}}{2} \right]^4}{\sum_{i=N_{cells}/2+1}^{N_{cells}} \left[\frac{N_{i+1} - N_{i-1}}{2} \right]^4} \quad (4.21)$$

where $i = 0..N_{cells}$ refers to the i^{th} bin in the y -axis and N_i is the number of particles belonging to the i^{th} cell (because of periodic conditions we assume that the index $i = N_{cells} + 1$ corresponds to the first cell labeled by index $i = 0$). As shown in figure 4.8 the output associated to the different definitions for the equilibrium case presents a signal fluctuating around an average value which is different according to the assumed definition. In the equilibrium case, we expect the PDF associate to the fluctuations to be symmetric around the mean value and to be approximated by a gaussian. As we give a look to the PDF associated to the different length definitions (figure 4.9) it immediately reveal the asymmetric behaviour of fluctuations in the L_2 and L_4 candidates. It immediately follows that the candidates presenting an even exponent of the gradient in the definition get affected by a systematic error which overestimate the positive fluctuations rather than the negative ones.

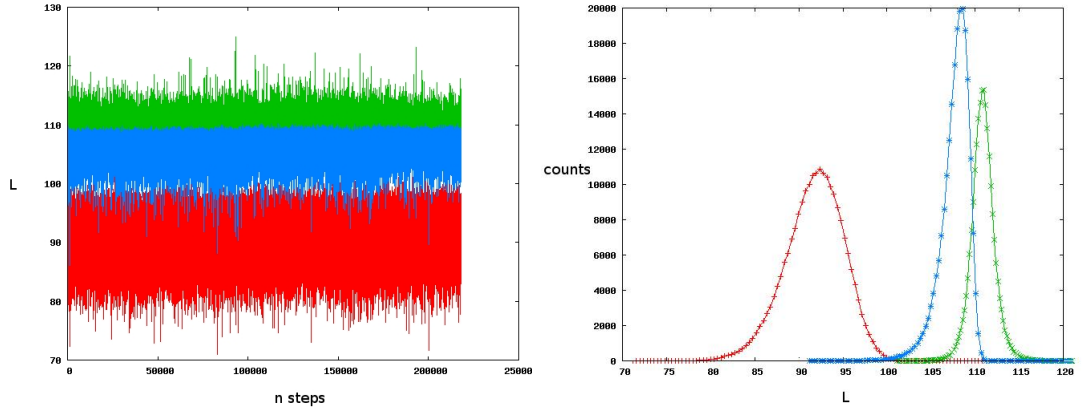

Figure 4.8: *Left panel:* 'end to end' distance taken according to the L_2 (red), L_3 (green), L_4 (blue). *Right panel:* the corresponding PDFs show that different definitions assume different average values and different distributions.

We have to remind that every of these definitions have to be taken with extreme

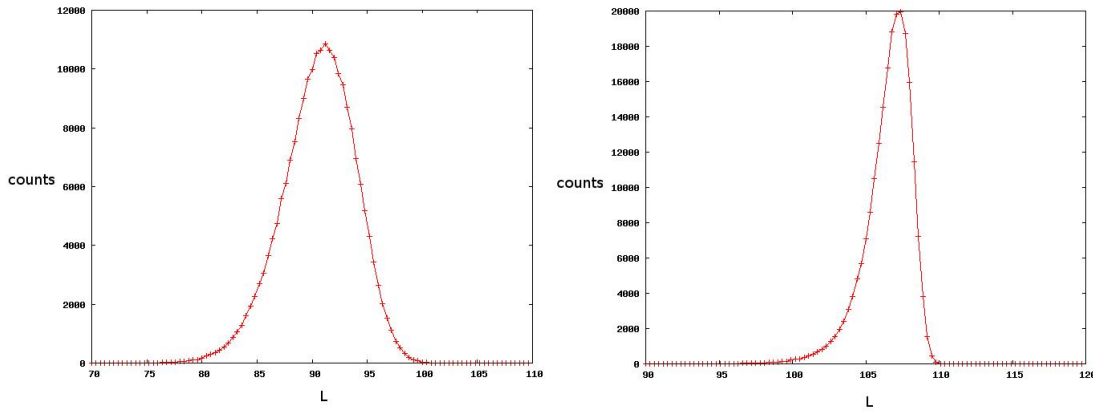

Figure 4.9: Asimmetries according to the PDF relative to the length definition L_2 (Left) and L_4 (right)

caution: it is compulsory to keep in mind that it is not possible to define a physical surface if the object is composed just by 10^4 interacting particles. As we take into account that a single mole of physical gas contains an Avogadro number of particles, it must be pointed out that the analysis described here cannot be explicative of a physical solid bar. Our purpose, in this framework, is to reveal some of the characteristic behaviour that can share a non-equilibrium physical system with our, limited, model. In synthesis, although we cannot pretend to infer any conclusion on the physics of the real macroscopic aluminium bar out of the behaviour of a bunch of particles, nevertheless, we aim to put in evidence some interesting emerging features which can reveal some crucial ingredients which may play important roles in non-equilibrium physical systems.

In our cell-structured space, lengths are necessarily discretized. As a detail of the L_1 'end to end' signal shown in figure 4.10, according to such definition, the corresponding PDF cannot be a continue distribution function, but it shows up as a discrete histogram, which is clearly unphysical. On the contrary, as we give a look

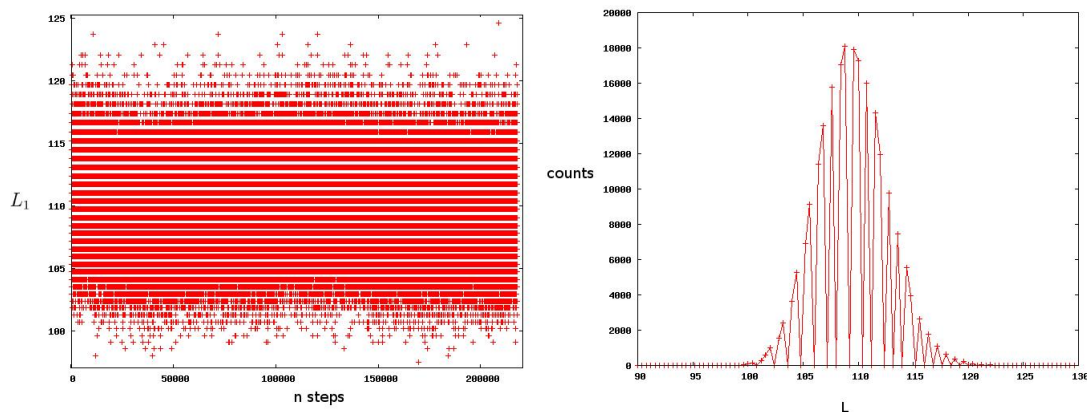

Figure 4.10: The space discretization implies that fluctuations (left panel) according to the definition L_1 cannot be continuous, as testified by the corresponding PDF (right).

to the corresponding PDF for the L_3 -definition, we can clearly see that the power of the gradient reset the continuity condition of the PDF of the 'end to end' distance.

From this and from all the previous consideration, it turns out that the best candidate is L_3 :

$$L_3 = \frac{\int_0^{L/2} y[\nabla(y)]^3 dy}{\int_0^{L/2} y[\nabla(y)]^3 dy} - \frac{\int_{L/2}^L y[\nabla(y)]^3 dy}{\int_{L/2}^L [\nabla(y)]^3 dy}$$

and, from now on, we will employ it in all the computations, and for brevity we will refer to it simply as L .

4.4.3 The non-equilibrium case

We now set the system out of equilibrium. We want to get a linear thermal gradient between the temperatures T_1 and T_2 set at the two surfaces. As showed in figure 4.12, starting from the equilibrium case (constant kinetical temperature $T = 0.3$), thermostatting the cells on the y -axis across the surfaces at temperatures $T_1 = 0.35$ - $T_2 = 0.25$, and letting the dynamics unthermostatted in the cells hosting the bulk, we get a linear temperature gradient through the longitudinal axis of the solid

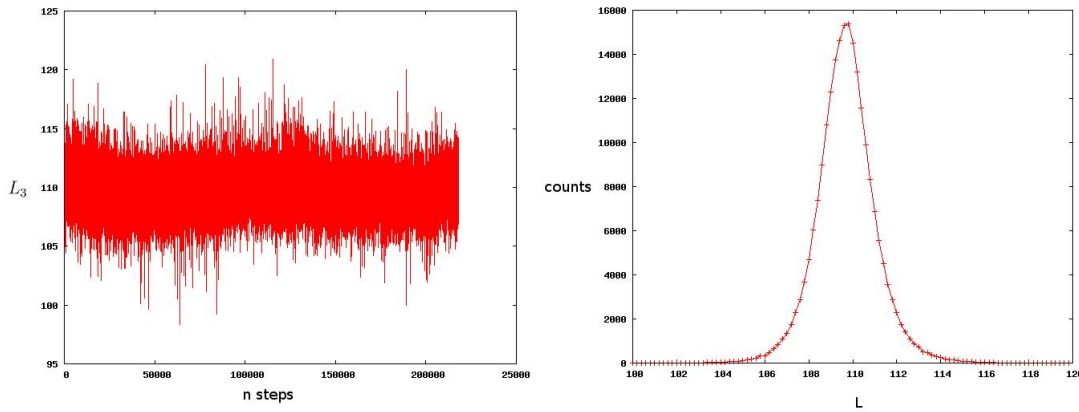

Figure 4.11: the fluctuations according to the observable L_3 (left), and the corresponding PDF (right).

bar.

As before, in order to reach the steady state, the dynamics has been kept in non-equilibrium conditions up to times of 10^6 timesteps, and the system did not show any criticism in stability. This is to mention as first result: the systems we took in exam showed stable configurations which do not degrade in time even when driven out of equilibrium. We registered no sudden evaporation or disintegration of the solid bar. At this stage we may finally compare the observable, according to the definition given by L , in the equilibrium configuration with the non-equilibrium case, as it is reported in figure 4.13. In non-equilibrium conditions the probability distributions looks broadened and with a lower peak which is slightly shifted on the right respect to the equilibrium condition. If we assume that this observable represent the longitudinal spatial dimension of the solid, we may say, then, that in equilibrium condition the surfaces of the solid are better defined (because of a narrower distribution) and the solid itself looks slightly shorter (because of the shifted peak) than the non-equilibrium case.

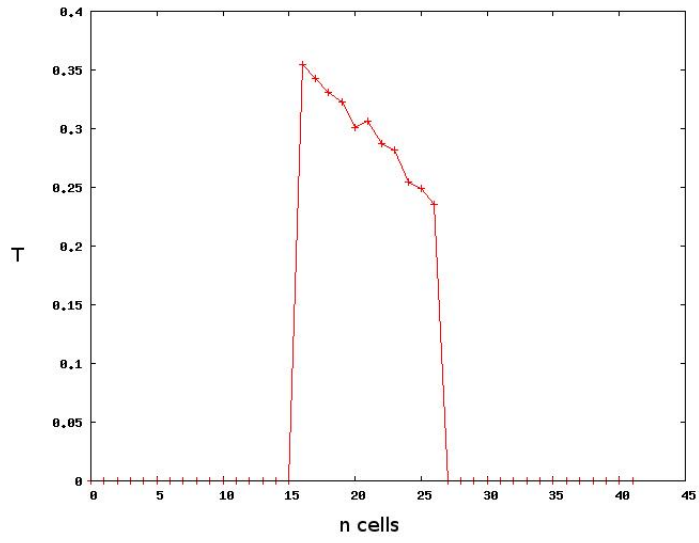

Figure 4.12: The linear temperature gradient in the non equilibrium case.

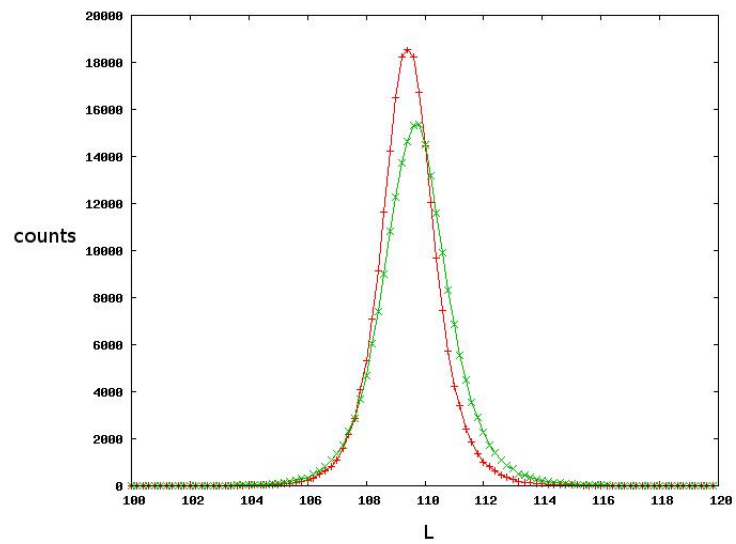

Figure 4.13: The PDF of length for the equilibrium case (in red) and for the nonequilibrium case (green).

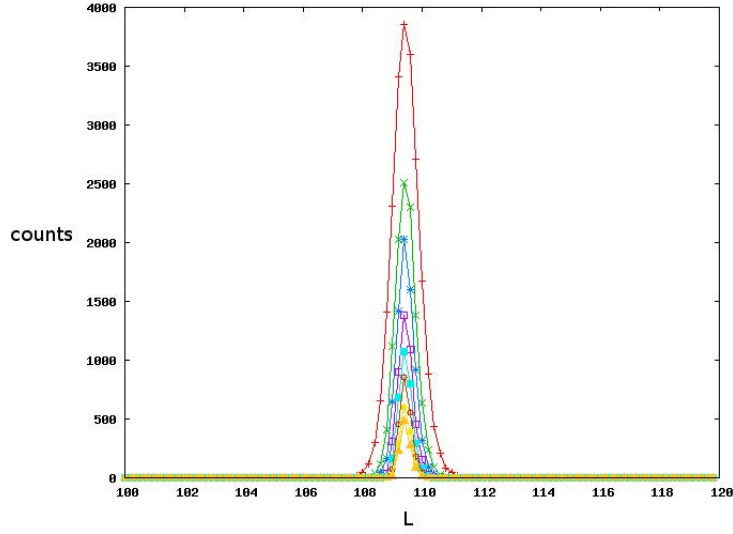

Figure 4.14: Unnormalized probability densities of L_τ for different τ .

We aim to verify the validity of the large deviation principle in our model. In such prospective, we start computing the PDFs for the time-average L_τ out of $L(t)$ over the interval $[0, \tau]$ according to the definition:

$$L_\tau = \frac{1}{\tau \langle L \rangle} \int_t^{t+\tau} L(s) ds \quad (4.22)$$

and then compute the corresponding probability distribution function P_τ (see figure 4.14).

Provided that $P_n(B_{p,\delta})$ is the probability that L_τ falls in the interval $B_{p,\delta} = (p - \delta, p + \delta)$, for some fixed $\delta > 0$, we say that the probability P_τ satisfies the large deviation principle if:

$$\lim_{\tau \rightarrow \infty} -\frac{1}{\tau} \log P_\tau(B_{p,\delta}) = \zeta(p) \quad (4.23)$$

or, in other terms, for $\tau \rightarrow \infty$:

$$P_\tau(p) \approx e^{-\tau \zeta(p)} \quad (4.24)$$

If the antisymmetric part of the functional $\zeta(p)$ is linear in p

$$\frac{\zeta(p) - \zeta(-p)}{p} = 1 \quad (4.25)$$

we may guarantee the validity of the Fluctuation Relation (FR).

In this framework, FR may be written according to the the following form:

$$\frac{1}{\tau \langle L \rangle} \log \left[\frac{P_\tau(p)}{P_\tau(-p)} \right] = p \quad (4.26)$$

4.5 The large deviation rate function

The large deviation principle as it was formulated in Eqs. (4.23),(4.25) does not hold. Our purpose is then to verify whether the model could instead satisfy the following conjecture: is it possible to generalize the large deviation principle such that the rate function rescales parametrically with an exponent $\alpha > 0$ according to the form:

$$\zeta(p) = \lim_{\tau \rightarrow \infty} \frac{1}{\tau^\alpha} \log P_\tau(p) = \lim_{\tau \rightarrow \infty} \zeta_\tau(p) \quad (4.27)$$

whith $\alpha \neq 1$? ¹ The conjecture (4.27) arises from the plot 4.15 which shows how the rate functionals get wider for increasing values of τ .

As immediate consequences, if Eq.(4.25) holds, a generalized fluctuation relation would still hold in the form

$$\frac{1}{\tau^\alpha \langle L \rangle} \log \left[\frac{P_\tau(p)}{P_\tau(-p)} \right] = p \quad (4.28)$$

We numerically investigated the existence of a large deviations functional $\zeta(p)$ according to the form given in equation (4.27) as function of α . At this stage, we

¹We remark that $\alpha = 1$ would reset to the ordinary form of the large deviation principle.

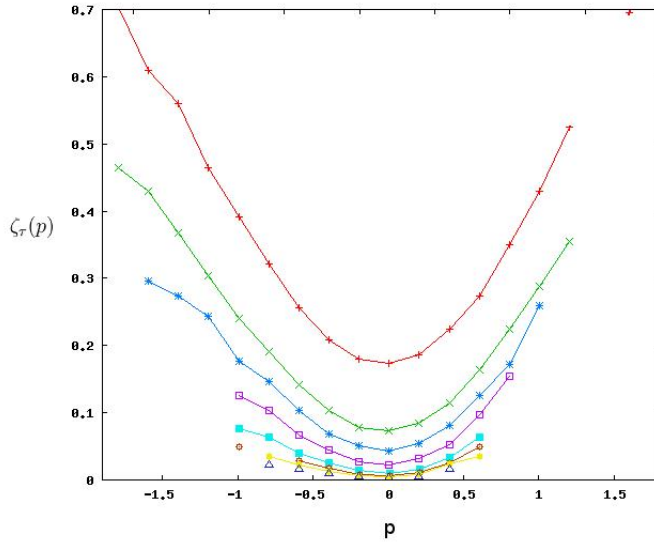

Figure 4.15: For $\alpha = 1$ the rate functionals $\zeta_\tau(p)$ get wider for increasing values of τ .

need to identify the correct α which allows the existence of a functional limit for the sequence of the $\zeta_\tau(p)$.

$\zeta_\tau(p)$ are strictly convex functionals and asymptotically must converge to the limit (4.27). If the central limit theorem applies, as expected, the ζ_τ rate functionals must be locally quadratic around the most probable value p_0 . In synthesis, locally around p_0 , holds:

$$\lim_{\tau \rightarrow \infty} P_\tau(p) = e^{-\frac{(p-p_0)}{2\sigma_\tau^2}} \quad (4.29)$$

In other terms, because of the gaussian approximation (as a consequence of validity of the Central Limit Theorem), if the standard large deviation principle would have applied we would have expected that $\sigma_\tau \sim (\sqrt{\tau})^{-1}$, [34]. On the contrary, in case (4.27) applies:

$$\sigma_\tau \sim \tau^{-\alpha/2} \quad (4.30)$$

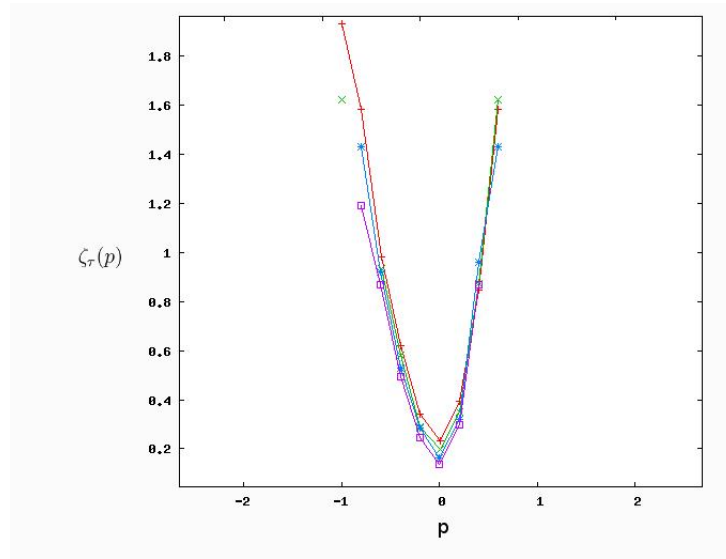

Figure 4.16: Rate functionals $\zeta_\tau(p)$ for different values of τ ($\tau = 100, 150, 200, 300$) and $\alpha = 0.3$

for a given α . So finally:

$$\lim_{\tau \rightarrow \infty} -\frac{1}{\tau^\alpha} \log P_\tau(p) = \frac{(p - p_0)^2}{2} \quad (4.31)$$

For $\alpha = 0.3$ we numerically verified that $\tau^\alpha \cdot \sigma^2$ converges to a constant. Indeed, in figure 4.17 we evaluate thus the FR for $\alpha = 0.3$. In the left panel we plot for all $\tau = 10, 20, 30, 50, 100, 150, 200, 300$ the $\frac{1}{\tau^\alpha} \frac{P_\tau(p)}{P_\tau(-p)}$ versus p .

In the right panel of the same figure 4.17, the same results are shown only for higher τ . Empirically we may conclude that $\frac{1}{\tau^\alpha \cdot p} \log \frac{P_\tau(p)}{P_\tau(-p)}$ asymptotically converges to a given constant value c , so that we may finally express the generalized FR in the form:

$$\frac{P_\tau(p)}{P_\tau(-p)} = e^{c \cdot \tau^\alpha \cdot p} \quad (4.32)$$

which holds, in the present case, for $\alpha = 0.3$.

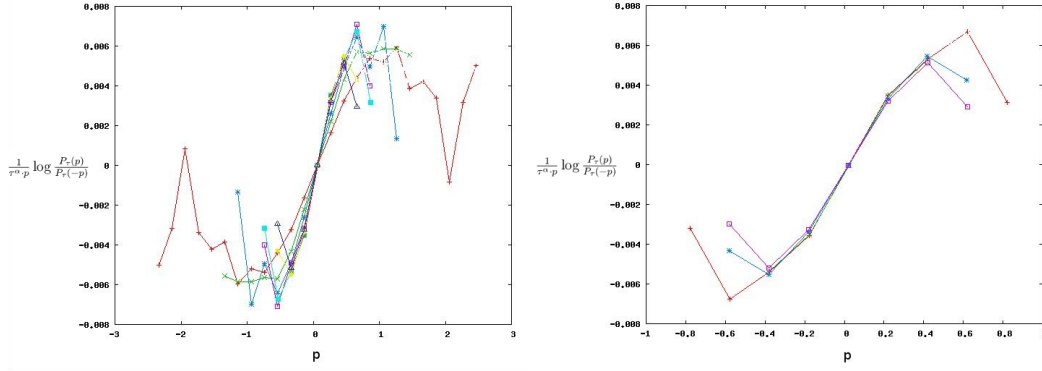

Figure 4.17: *Left panel:* plot of $\frac{1}{\tau^\alpha} \log \frac{P_\tau(p)}{P_\tau(-p)}$ versus p , for all the $\tau = 10, 20, 30, 50, 100, 150, 200, 300$, $\alpha = 0.3$. *Right panel:* the same plot, selecting only the highest $\tau = 150, 200, 300$, shows an asymptotic convergence to the limit slope c .

4.6 Conclusions

Summarizing, in this work we have investigated a thermostatted Lennard-Jones interacting particles system set in a nonequilibrium steady state and performed a fluctuation analysis aimed to verify the FR. The first important results to mention is that in nonequilibrium conditions we could keep stable configurations for time of the order of 10^6 timesteps. Furthermore, we tested four different definitions and found the best candidate for the observable describing the system length, which in principle is hard to define at the microscopic scale. Nevertheless, we observed in our numerical investigation the validity of a generalized principle of large deviations for the probability density P_τ which points out the existence of a generalized FR on the basis of the conjecture expressed in Eq.(4.27). In addition, the annealing procedure adopted to reach a stable steady state and described in 4.4.1 confirmed to be a valid and advantageous method.

Chapter 5

Conclusions

The FRs represents an exact result in describing a wide variety of nonequilibrium systems: indeed, we applied such result in MD simulations as in discrete Dynamical Systems (respectively, in chapter 4 and chapter 2). Physically, it is worthwhile to investigate which of the properties of real dynamical systems are also required in the models for the FRs to hold.

Despite the fact that ergodicity is a hard hypothesis to be fulfilled in physical systems, FRs have been amply verified in nature. Nevertheless, from the analysis of our generalized Baker Map in chapter 2, we concluded that the required ergodicity condition at equilibrium represents, for the transient FR, not only a sufficient but also a necessary hypothesis. That looked explicative, in the sense that it warned us to use caution in the attempt to extend the generality of the FRs by weakening the original hypothesis.

FRs originally built a connection between dynamical and thermodynamical properties of nonequilibrium systems. Indeed, the system size plays a fundamental role

since it influences the decay of correlations: as we have seen, anomalous FRs [43, 2] are possible in NEMD systems of few degrees of freedom, where correlations decay slowly. Our interest in the t-mixing condition and its implications in the correlation decay arise from here, although the discussion on this peculiar item is still in progress. From the transient Ω -FRs toward a steady-state form, we have been considering the conditions under which this extension is possible. The t-mixing, which is related to the decay in correlations of the dissipation function, expresses formally this condition.

This concludes our discussion on the results obtained from the applied models in this thesis: we remark that reversibility, existence of a unique steady state and t-mixing condition are reasonable and physically consistent dynamical properties and, at the same time, sufficient hypothesis for the Evans-Searls steady-state FR to hold. In principle this may improve our knowledge about the physical mechanism which leads to the emerging thermodynamic irreversibility out of the microscopic reversible dynamics, and explains why it is so generally verified.

Bibliography

- [1] Avez A Arnold, V I. Ergodic problems of classical mechanics. *Physica A*, 196:86, 1968. [59](#)
- [2] G. Ayton, D. J. Evans, and D. J. Searles. A Local Fluctuation Theorem. *eprint arXiv:cond-mat/9901256*, January 1999. [104](#)
- [3] DJ Evans B D Todd, P J Daivis. Heat flux vector in highly inhomogenous nonequilibrium fluids. *Physical Review E*, 51, 1995. [80](#)
- [4] B Smit D Frenkel. *Understanding Molecular Simulation*. Academic Press, 2002. [7, 8](#)
- [5] L Rondoni D J Evans, S R Williams. A mathematical proof of the zeroth law of thermodynamics and the nonlinear fourier law for the heat flow. *J. Chem. Phys.*, 137:194109, 2012. [59](#)
- [6] S R Williams D J Evans. *J. Chem. Phys.*, 132:184105, 2010. [59](#)
- [7] J R Dorfman. An introduction to chaos in nonequilibrium statistical mechanics. *Cambridge University Press*, pages 89–99, 1999. [4, 6](#)

- [8] D J Evans, E G D Cohen, and G P Morriss. Probability of second law violations in shearing steady flows. *Phys. Rev. Lett.*, 71:2401, 1993. [14](#), [15](#), [16](#)

- [9] D J Evans, E G D Cohen, D J Searles, and F Bonetto. Note on the Kaplan-Yorke dimension and linear transport coefficients. *J. Stat. Phys.*, 101:17, 2000. [17](#)

- [10] D J Evans and G P Morriss. *Statistical Mechanics of Nonequilibrium Liquids*. New York: Academic Press, 1990. [26](#), [28](#)

- [11] D J Evans and D J Searles. Equilibrium microstates which generate second law violating steady states. *Phys. Rev. E*, 50:1645, 1994. [22](#), [31](#)

- [12] D J Evans and D J Searles. Steady states, invariant measures, response theory. *Phys. Rev. E*, 52:5839, 1995. [22](#), [31](#)

- [13] D J Evans and D J Searles. The dissipation theorem. 2007. (submitted). [28](#)

- [14] D J Evans, D J Searles, and G P Morriss. (in preparation). [26](#)

- [15] D J Evans, D J Searles, and L Rondoni. On the application of the Gallavotti-Cohen fluctuation relation to thermostatted steady states near equilibrium. *Phys. Rev. E*, 71:056120, 2005. [18](#), [28](#)

- [16] D J Evans, D J Searles, and L Rondoni. The steady state fluctuation relation for the dissipation function. *J. Stat. Phys.*, 2007. in press. [1](#), [23](#), [25](#), [28](#), [57](#), [60](#)

- [17] Williams S R Evans D J, Searls D J. Dissipation and the relaxation to equilibrium. *Journal of Statistical Mechanics*, 128:249901, 2008. [65](#)

- [18] Williams S R Evans D J, Searls D J. On the fluctuation for the dissipation function and its connection with response theory. *Journal of Chemical Physics*, 128:014504, 2008. [60](#), [65](#)
- [19] Fluctuations Theorem for Entropy Production in Open System. *Physical Review E*, 61, 2000. [32](#)
- [20] Benettin G. Introduzione alla teoria ergodica. <http://www.math.unipd.it/~benettin>. [6](#)
- [21] G Gallavotti. Reversible Anosov diffeomorphisms, large deviations. *Math. Phys. Electronic J.*, 1:1, 1995. [15](#), [25](#)
- [22] G Gallavotti. Extension of Onsager's reciprocity to large fields, the chaotic hypothesis. *Phys. Rev. Lett.*, 77:4334, 1996. [28](#)
- [23] G Gallavotti. Fluctuation theorem revisited. 2004. <http://arXiv.org/cond-mat/0402676>. [15](#)
- [24] G Gallavotti and E G D Cohen. Dynamical ensembles in nonequilibrium statistical mechanics. *Phys. Rev. Lett.*, 94:2694, 1995. [15](#), [31](#)
- [25] G Gallavotti and E G D Cohen. Dynamical ensembles in stationary states. *J. Stat. Phys.*, 80:931, 1995. [16](#), [18](#)
- [26] G. R. W. Quispel J. A. G. Roberts. Chaos and time-reversal symmetry. order and chaos in reversible dynamical systems. *Phys. Rep.*, 216:63, 1992. [35](#)
- [27] D Ruelle J P Eckmann. Ergodic theory of chaos and strange attractors. *Review of Modern Physics*, 57, 1985. [49](#)

- [28] A I Khinchin. *Mathematical Foundations of Statistical Mechanics*. Dover Publications, New York, 1949. [20](#)
- [29] R Klages. Microscopic chaos, fractals and transport in non-equilibrium statistical mechanics. *World Scientific*, 2007. [40](#)
- [30] Juraĵ Kumiĉák. Irreversibility in a simple reversible model. *Phys. Rev. E*, 71:016115, Jan 2005. [32](#)
- [31] C M Monasterio L Rondoni. Fluctuations in nonequilibrium statistical mechanics: Models, mathematical theory, physical mechanism. *Physical Review Letters*, 137:010601, 2009. [3](#), [8](#), [16](#)
- [32] L Conti P De Gregorio M Bonaldi. Nonequilibrium steady-state fluctuations in actively cooled resonators. *Physical Review Letters*, 137:010601, 2009. [80](#)
- [33] L Rondoni M Colangeli. Equilibrium, fluctuation relations and transport for irreversible deterministic dynamics. *Physica D*, 241:681–691, 2012. [31](#), [32](#), [33](#), [34](#), [36](#)
- [34] L Rondoni M Colangeli. Fluctuations in quantum one-dimensional thermostatted systems with off-diagonal disorder. *arXiv:1212.1092v1*, 2012. [98](#)
- [35] L Rondoni M Colangeli, R. Klages. Steady state fluctuations relations and time-reversibility for non-smooth chaotic maps. *Journal of Statistical Mechanics*, 2011. [31](#), [32](#), [33](#), [34](#), [36](#)
- [36] L Rondoni O G Jepps. Deterministic thermostats, theories of nonequilibrium

- systems and parallels with the ergodic condition. *J. Phys. A: Math. Theor.*, 43:133001, 2010. [3](#), [8](#)
- [37] K Gawedzki R Chetrite. *Comm. Math. Phys.*, 282:469, 2008. [16](#)
- [38] C Jarzinski R Klages, W Just. *Nonequilibrium Statistical Physics of Small Systems: Fluctuation relations and beyond*. Wiley-VCH, 2012. [3](#)
- [39] D J Searles and D J Evans. Ensemble dependence of the transient fluctuation theorem. *J. Chem. Phys.*, 113:3503, 2000. [29](#)
- [40] Evans D J Searls D J, Rondoni L. The steady state fluctuation relation for the dissipation function. *Journal of Statistical Physics*, pages 1337–1363, 2007. [80](#)
- [41] Ya G Sinai. *Lectures in Ergodic Theory*. Lecture Notes in Mathematics, Princeton University Press, 1977. [16](#)
- [42] H. Touchette. The large deviation approach to statistical mechanics. *Physics Reports*, 478:1–69, 2009. [9](#)
- [43] H. Touchette and E. G. D. Cohen. Anomalous fluctuation properties. , 80(1):011114, July 2009. [104](#)
- [44] L Rondoni A Vulpiani U Marini Bettolo Marconi, A Puglisi. Fluctuation dissipation: Response theory in statistical physics. *Physics Reports*, 461:111–195, 2008. [16](#)
- [45] J Vollmer. Chaos, spatial extension, transport, and non -equilibrium thermodynamics. *Physics Reports*, 372:131–267, 2002. [4](#), [6](#), [35](#)