

Conceptual design of a habitation module for a deep space exploration mission

*Original*

Conceptual design of a habitation module for a deep space exploration mission / Viscio, MARIA ANTONIETTA; Viola, Nicole; Eugenio, Gargioli; Ernesto, Vallerani. - In: PROCEEDINGS OF THE INSTITUTION OF MECHANICAL ENGINEERS. PART G, JOURNAL OF AEROSPACE ENGINEERING. - ISSN 0954-4100. - STAMPA. - 227:(2013), pp. 1389-1411. [10.1177/0954410012457292]

*Availability:*

This version is available at: 11583/2498659 since:

*Publisher:*

SAGE

*Published*

DOI:10.1177/0954410012457292

*Terms of use:*

openAccess

This article is made available under terms and conditions as specified in the corresponding bibliographic description in the repository

*Publisher copyright*

Sage postprint/Author's Accepted Manuscript

(Article begins on next page)

# CONCEPTUAL DESIGN OF A HABITATION MODULE FOR A DEEP SPACE EXPLORATION MISSION

**Ms. Maria Antonietta Viscio**

Politecnico di Torino, Italy, [maria.viscio@polito.it](mailto:maria.viscio@polito.it)

**Dr. Nicole Viola**

Politecnico di Torino, Italy, [nicole.viola@polito.it](mailto:nicole.viola@polito.it)

**Mr. Eugenio Gargioli**

Thales Alenia Space Italia, Italy, [eugenio.gargioli@thalesalieniaspace.com](mailto:eugenio.gargioli@thalesalieniaspace.com)

**Prof. Ernesto Vallerani**

International Space Pioneers, Italy, [cris.vallerani@iol.it](mailto:cris.vallerani@iol.it)

The paper deals with the conceptual design of a habitable module conceived for long duration space exploration missions. The pressurized habitation module (HAB) was specifically sized for a Near Earth Asteroid (NEA) mission, named AENEA “humAn Exploration mission to a Near Earth Asteroid”. This mission is conceived as an intermediate step before going to further destinations and aims at testing technologies necessary for reaching more challenging targets. In accordance to the mission objectives, the HAB was devised as a reusable space infrastructure, suitable for different exploration scenarios with only minor changes in the architecture/design.

The paper describes the design process that, starting from the mission statement, was followed to define the objectives, the requirements and the architecture of the module in terms of system and subsystems configuration. In particular, the HAB was designed to safely sustain the life of 4 astronauts, for a mission to a NEA lasting about 6 months. The main subsystems of the HAB were sized in order to provide the astronauts with the needed resources, support the activities during all operational phases, including the Extra Vehicular Activities (EVA) on the asteroid’s surface, and protect them against the external environment, with particular attention to the space radiation, one of the most critical aspects of this kind of mission. In this regard, appropriate analyses were carried out for selecting the best shielding strategy. For the execution of the EVAs on the asteroid surface, a dedicated airlock and specific EVA support tools were included. The paper reports a detailed description of the subsystems and their innovative aspects. Starting from the mission phases and the related scenarios, different modes of operations were identified. System budgets were evaluated for the envisaged operational modes. The paper illustrates both the applied methodologies and the results, highlighting the major criticalities to be faced (long exposure to space radiations, EVA operations on the asteroid surface) and the key technologies (radiation shielding, inflatable technology, EVA support tools).

Keywords: conceptual design, Near-Earth Asteroid, human space exploration, habitation module

## I. INTRODUCTION

The next step in human space exploration is to travel beyond low Earth orbit. This would carry important benefits to society, including: technological innovation, development of commercial industries and important national capabilities and contribution to our expertise in further exploration.

Human exploration can contribute appropriately to the expansion of scientific knowledge and it is in the interest of both science and human spaceflight that a credible and well-rationalized strategy of coordination between them is developed. The ultimate goal of human exploration is to chart a path for human expansion into the solar system and in this regard asteroids could represent an intermediate step before going to further destinations such as Mars, due to the many benefits they can offer. In particular, the exploration of an asteroid can be attractive since such a mission would offer the possibility to test technologies in view of further missions as well as to eventually exploit resources. In addition the deflection of hazardous asteroids trajectories would be a very significant motivation for missions to asteroids.

As a matter of fact some robotic missions have already been specifically designed to explore asteroids or comets. Some examples are:

- NEAR shoemaker, which orbited Eros and analysed its surface with remote-sensing instruments,
- Stardust, which was the first sample return mission to collect cosmic dust, from the comet Wild2, and return it to Earth,
- Hayabusa, the Japanese mission that aimed at acquiring samples from the surface of the near-Earth asteroid 25143 Itokawa and returning them to Earth.

Today many studies about human exploration missions to near Earth asteroids are currently on going, especially in view of exploration missions towards further destinations. For example, Lockheed Martin Corporation has proposed the Plymouth Rock [1], a concept of an early human asteroid mission using Orion.

NASA HEFT team is putting large effort in asteroids exploration missions, in terms of mission scenarios and architectures definition, as well as in terms of technologies assessment (Deep Space Habitat enabling long duration mission, strategies for approaching the NEO) [2], [3].

In line with the current scientific community interest in asteroids exploration, the paper presents the conceptual design of a habitation module for a human exploration mission to a NEA (AENEA mission)[4], [5].

The habitation module described in the paper was designed according to specific requirements, deriving from the well-defined AENEA mission. The adopted approach for AENEA mission is different from the Plymouth Rock one that instead is based on the use of the Orion capsule as pressurized module for the crew. Moreover the AENEA mission module is also different from the NASA HEFT one, due to different requirements and design solutions, as for instance the different number of crewmembers, the different mission durations and different NEA exploration approach (e.g. the use of a Multi Mission Space Exploration Vehicle is not foreseen in AENEA mission, thus the need of a dedicated airlock for the execution of EVAs). [3]

AENEA is a human exploration mission of a Near Earth Asteroid that lasts about 6 months with a crew of four astronauts. Fig.1 illustrates its mission profile.

The overall spacecraft is composed of two transportation modules (TMs), in charge of providing the required thrust for the travel to the asteroid and back, a pressurized habitation module (HAB) to host the crew, a service module (SM) and a capsule (CM) for the Earth re-entry of the crew. The spacecraft is envisaged to be assembled in a Low Earth Orbit (LEO) where the different modules are injected by means of two heavy lift launch vehicles\*, in charge of lifting the transfer stages and the habitation module, and one crew launch vehicle, in charge of launching the service module and the capsule with the crew.

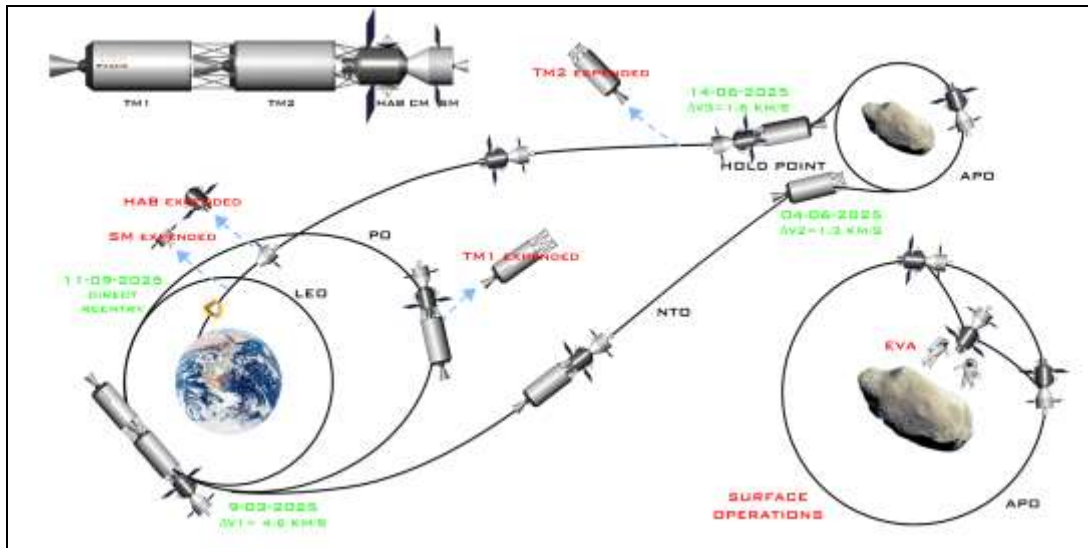

Fig. 1: AENEA Mission Profile

After assembly is completed, the spacecraft, after one revolution in an Earth Parking Orbit, where it is put with the first TM injection, is inserted into a NEA Transfer Orbit. After about 3 months travel the spacecraft arrives in proximity of the asteroid and the second TM (TM2) performs the second manoeuvre for putting the spacecraft in formation flight with the NEA. During the NEA surface operations, the TM2 is detached from the other modules of the spacecraft and remains at a distance of about 20 km from the asteroid; only the habitation module, attached to the capsule and the service module, gets close to the asteroid. During about ten days, that are envisioned to spend around the asteroid, several Extra Vehicular Activities (EVA) are going to be performed. During EVAs, the spacecraft approaches the asteroid for releasing the astronauts, but does not land on its surface. After NEA operations, TM2 and

\* The adopted heavy lift launch vehicle was analysed in the frame of the same AENEA mission study.

HAB+CSM dock again and begin their travel back to Earth. TM2 and SM, in sequence, perform the insertion in the Earth Transfer Orbit. After injection, TM2 is expended and only HAB and CSM continue the trip back to Earth. After about 3 months of travel the spacecraft reaches the proximity of the Earth, where HAB and SM are released and put in a destroying trajectory. The mission ends with a direct re-entry in the Earth's atmosphere of the capsule.

The pressurized habitation module was specifically sized to respond to the needs of AENEA mission, but it is devised as a versatile space infrastructure, suitable for different exploration scenarios provided that specific minor modifications in the architecture/design are introduced accordingly to the mission's peculiarities.

The paper focuses on the description of the pressurized habitation module as designed for AENEA mission. In the first part a description of the methodology adopted for the design is reported, describing the workflow that was followed and highlighting its main steps. The second part of the paper reports the description of the overall module, as well as a description of the subsystems composing it. The last part shows a summary of the budgets (mass, power) that were estimated. Major criticalities that need to be faced (long exposure to space radiations, EVA operations on the asteroid surface) and key technologies that need to be developed (radiation shielding, inflatable technology, EVA support tools) are underlined within the text.

## II. METHODOLOGY

In this section the work flow and the methodologies adopted for designing the habitation module are described, starting from the requirements assessment up to the definition of the system architecture. The last part of this sections focuses on the subsystems description.

### II.1 Requirements Definition

The process followed for the module design is schematically described by the work flow shown in Fig.2.

The pressurized habitation module was designed accordingly to AENEA mission requirements. The process has begun by defining the HAB mission statement that is reported hereafter:

*“To provide 4 crewmembers with a safe and comfortable environment for a 186 days mission to a NEA, providing them with resources, protecting them against the external environment, supporting IVAs and EVAs”*

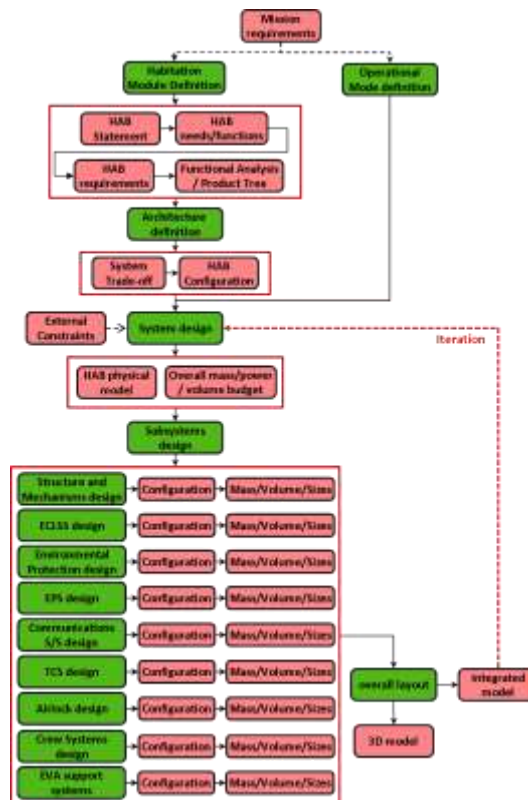

Fig. 2: Work Flow describing the process followed for the habitation module design

Starting from the mission statement, the needs and functions that HAB has to accomplish were derived. HAB has been conceived as a pressurized module, which has to sustain the life of 4 astronauts for almost all AENEA mission duration, providing the crew members with all those functionalities necessary for guaranteeing a safe environment and ensuring their good health.

Accordingly, HAB requirements were derived and can be here summarized as follows: the HAB shall provide:

- a free volume of 15m<sup>3</sup>/crewmember,
- the resources necessary for 4 astronauts for 186 days mission,
- protection against external environment (temperature, MMOD, radiation),
- controlled internal environment and adequate conditions for the crew activities (accordingly to NASA-STD-3000 [6]),
- communications among the astronauts and with ground,
- power supply and thermal control to support the mission for all its duration,
- support for EVAs execution,
- specific interfaces with the adopted launcher (the launcher compatibility is described in the following),
- interfaces with the capsule.

HAB is envisioned to be launched in LEO, where it is assembled with the other modules of the spacecraft, by means of a heavy lift launch vehicle, called Hyperion. This launcher was studied in the frame of the SEEDS project work, since the available launchers are not compatible with the total mass required to be put in LEO [*Viscio et Al. "AENEA Report: Project Work - Phase II", September 2010, unpublished results*].

The envelope constraints due to the launcher are (Fig. 3):

- Cylinder Diameter: 8 m
- Cylinder Height: 10 m
- Available Cone Height: 5m
- Payload Mass: 23 tons



Fig. 3: HAB interfaces with the Hyperion launcher

On one of the axial extremities, HAB presents the interface with the payload adapter of the launcher, while on the other extremity there is the docking hatch where the command module has to be connected for almost all mission duration, until few hours before the atmospheric re-entry of the capsule.

Once the definition of the HAB requirements was completed, the functional analysis was performed in order to identify the needed subsystems in charge of accomplishing the required functions; as a result, the major subsystems were identified (i. e. the Structures and Mechanisms, Airlock, Environmental Protection, Environmental Control and Life Support System (ECLSS), Electrical Power System, Thermal Control System, Communications, EVA support system and Crew systems) and preliminary designed.

As a following step, several trade-offs were identified and performed, regarding the overall configuration of the module.

The design of the system was carried out considering the main constraints (due to the external environment, the compatibility with the launcher, and so on) and pursuing an iterative process. The main subsystems composing the module were characterized and designed in terms of configuration and budgets (mass, volume, dimension), and, finally, the overall layout of the module was derived.

The working mode (especially in terms of power absorbed and duty cycle) of subsystems depends on the operational modes that HAB assumes in the different mission phases. In particular, Table 1 reports the summary of the identified operational modes, underlining the phases in which they are adopted.

	Launch	Assembly	Transfer to NEA	NEA operations	Transfer to Earth
Nominal			x	x	x
LEO check		x			
Safe		x	x	x	x
SPE			x	x	x
EVA				x	
Night			x	x	x
Stand-by	x				

Table 1: Operational Modes (Nominal, LEO check mode, Safe mode, SPE mode, EVA mode, Night mode, Stand-by mode) vs Mission Phases (Launch, Assembly, Transfer to NEA, NEA operations and Transfer to Earth)

## II.II System Architecture Definition

Several trade-offs were carried out in order to determine the best configuration for the module. The comparison among the identified alternative solutions was conducted on the basis of specific parameters. Each parameter was assigned a weight depending on the relative importance it has with respect to the others. The main performed trade-offs regard the type of structure to be adopted (rigid module versus inflatable), the airlock configuration and the shielding against radiation (passive versus active shielding).

In the following subsections a summary of the trade-off results is reported; for a more detailed description refer to Appendix A.

### HAB structure: rigid vs inflatable

The possibility to adopt an inflatable primary structure for the crew living module instead of a rigid one was analysed, since it would imply many advantages that become much more significant in view of future longer missions. As a matter of fact, the inflatable technology would allow a greater operational volume to launch volume ratio and a greater volume to mass ratio.

On the other hand the rigid solution could rely on a much wider industrial heritage; in addition, it has a less complex structural architecture and does not require the outfitting procedures needed for the inflatable modules.

In accordance with these considerations, the driving parameters used to perform the trade (with the respective assigned weights reported in brackets) are:

- operational volume over launch volume ratio (35%),
- architecture complexity (20%),
- outfitting (20%),
- industrial heritage (15%),
- volume over mass ratio (10%).

By comparing the two options, adopting a rigid module resulted to be the preferable solution.

### Airlock position

AENEA mission envisages several days to be spent in the asteroid proximity, where astronauts are intended to perform a certain number of EVAs. Furthermore, during the travel, the necessity for contingency EVAs may arise. Therefore, an airlock was introduced as part of the HAB to allow EVAs to be performed. Four different solutions were identified and traded for the positioning of the airlock, as shown in Fig.4.

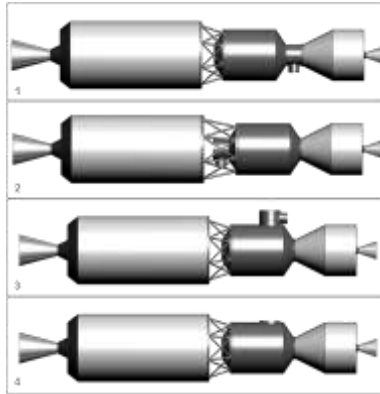

Fig. 4: Alternative airlock positions: 1) between the crew living module and the capsule; 2) between the crew living module and the TM; 3) radially attached rigid structure; 4) radially attached inflatable structure.

The three main parameters considered for the trade-off (with their respective assigned weights reported in brackets) are the structural complexity (50%), the architecture complexity (30%) and the operational complexity (20%).

As a result of the comparison, the solution foreseeing the airlock positioned between the crew living module and the TM was chosen. Indeed, it presents several advantages:

- it does not prevent the passage of the astronauts from CM to HAB during EVA, as the first option would imply,
- there is no need for a robotic arm to re-position the Airlock after launch,
- the axial position is preferable from a structural standpoint.

On the other hand, the selected configuration implies a higher complexity in the execution of EVA during flight, when the transfer stage is still attached to the HAB, due to the presence of the truss. The third and fourth configurations are not convenient both from a structural point of view and for compatibility reasons with the launcher fairing.

Airlock structure: rigid vs inflatable

To allow astronauts to wear the space suits and to exit outside the S/C two independent compartments are needed: an Equipment Lock (EL), consisting of a pre-breathing and donning area, and a Crew Lock (CL), allowing the egress of the astronauts after having been depressurized. Six possible configurations were identified and are schematically shown in Fig. 5.



Fig. 5: Alternative airlock configurations: 1) EL integrated with HAB plus rigid CL; 2) EL integrated with HAB plus inflatable CL; 3) unique rigid module for both EL and CL separate internally through a bulkhead; 4) unique inflatable module for both EL and CL separate internally through a bulkhead; 5) independent rigid EL and rigid CL; 6) independent rigid EL and inflatable CL.

The trade-off among the six configurations was carried out considering the same parameters used for the crew living module configuration trade-off. As a result, the adopted solution is the sixth one, foreseeing an inflatable CL and a rigid EL, mainly because it is the most convenient in terms of volume over mass ratio.

The presence of an inflatable structure is quite a challenging task due to the limited experience in the field, but at the same time it gives the possibility to test this technology on a reduced scale, in view of future wider applications.

On the other hand, having a rigid EL allows to reduce the outfitting requirements and allows to better allocate the suits and tools required for EVA, that would instead represent a problem in case of a totally inflatable airlock.

#### Radiation Shielding: passive vs active

The space radiations represent one of the most critical issues, for the human interplanetary exploration. Thus, an adequate protection must be included in the HAB design, in order to maintain radiations dose absorbed by astronauts during their travel below the allowed limits. Different solutions could be envisaged and at first a trade-off between active and passive shielding was done. The considered driving factors (with the respective assigned weights reported in brackets) are: mass (40%), reliability and implications on safety (30%), architecture complexity (20%), and impact it has on the other subsystems (10%).

The passive shielding turned out to be the most convenient. As matter of fact, it is much simpler to be developed and managed than an active solution, and does not have great impact on other subsystems, as instead an active solution would imply (e.g. power consumption, electromagnetic interference,...). Adopting an active technology would be advantageous in terms of mass, but present TRL of this technology is still very low.

### II.III HAB Configuration

The overall Habitation Module includes the so called Crew Living Module (CLM), which is where astronauts actually live during the mission, and the airlock, which is considered as an independent system. .

Fig.6 provides an external view of the overall HAB system. The architecture of the module is inspired by the ISS modules: it is shaped like a cylinder with 2 cones on the bases; the habitable volume is in the central part of the cylinder, both for structural and radiations protection reasons.

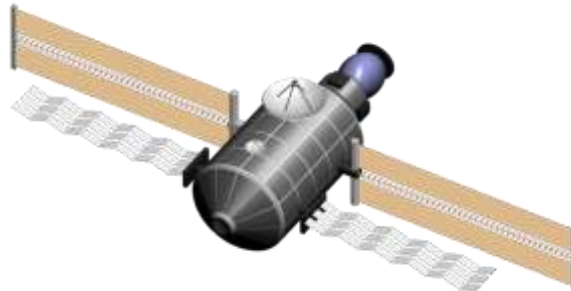

Fig. 6: HAB external architecture overview

CLM has a diameter of 5 m and a total length of 9 m (7 m for the cylinder and 1 m for each cone), which ensures an overall volume of about 160 m<sup>3</sup>. This value for the total volume derives from considerations about both the free volume to be guaranteed to the crewmembers and the volume required for accommodating the equipment needed to sustain the entire mission. In particular, a free volume of 15m<sup>3</sup>/crewmember was considered, representing a mean value between the optimal and the performance limit, as shown in the graph of Fig.7, which corresponds to an overall required free volume of 60m<sup>3</sup>.



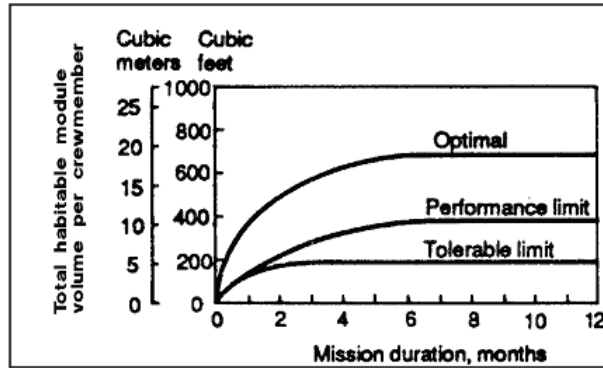

Fig. 7: Total habitable module volume per crewmember [6]

The remaining 100m<sup>3</sup> represent the volume needed to accommodate the subsystems and crew systems (some details are reported later in the paper).

The appendices attached externally to HAB are:

- the solar arrays;
- the radiators;
- an S-band antenna;
- two K-band antenna (for redundancy reasons);
- a docking hatch to allow the passage from the HAB to the command module.

Both the solar panels and the radiators are deployable and can rotate around their symmetry axis to get the best orientation with respect to the Sun, i.e. to maximize the solar radiation absorption on the solar arrays and to minimize it on the radiators. In Fig.6 the nominal orientation is shown, that is during the flight towards the asteroid and back.

The internal configuration is characterized by racks, compartments and stand-off, which are supported by the secondary structure; the external envelope is designed to support the external loads and the internal pressure and to guarantee the mechanical interfaces, protection and insulation against external environment.

The subsystems composing the spacecraft that were studied are: structure and mechanisms, airlock, environmental protection (which includes both the MMOD protection and the shielding against space radiations), Environmental Control and Life Support System (ECLSS), Electrical Power System, Thermal Control System, Communications, EVA support system and the Crew systems, which include all means needed for the daily activities of the crew.

## II.IV HAB Subsystems Sizing

This subsection reports an overview of the main subsystems that were analysed.

### Structure and Mechanisms subsystem

The structural design of the HAB started with the definition of the different loads it must sustain during its lifetime, which are test, handling, transportation, launch and post launch loads. In particular, the dynamic loads of the launch phase are the most significant and therefore they were the driving loads for the structural design.

The main objectives of the preliminary structural design are the selection of materials and type of structure to be adopted, as well as the definition of the configuration and the identification of interfaces, according to the flight experience already gained with similar modules.

Among different identified manufacturing options a skin-stringer configuration was selected, that is a skin wrapped around an assembly of stringers and ring frames, since it offers the best performances considering the loads to be withstood. By the way this solution is usually the one used for launch vehicles, spacecraft and pressurized sections. The selected materials for the HAB structure are two Aluminium Alloys:

- Al 2219-T851 for the shell of both the cylindrical and the conical parts,
- Al 7075-T73 for the rings and the frames.

The shell thickness of both the cylinder and the cones was sized to withstand the loads due to the internal pressure, which is assumed to be equal to 91kPa (see the subsection “Environmental Control and Life Support System”). Reinforcements were introduced for stability reasons, in order to avoid buckling, increase strength, transmit and share the loads [7].

The final HAB structure configuration envisages:

- a shell thickness of 2.16 mm;
- 12 stringers (longitudinally), with a cross-section of 20.5mm x 30mm, and 11 frames (circumferentially), with a cross-section of 20mm x 30mm, on the cylinder,
- 12 stringers (longitudinally), with a cross-section of 14mm x 30mm, and 1 frame (circumferentially), with a cross-section of 20mm x 30mm, on the cones.

In the structure design the hatch connecting HAB with the command module was included, as well as a window on the lateral surface of the cylinder. The window, having a diameter of 0.6m, was included in the module mainly for psychological reasons.

### Airlock

The Airlock allows the EVA crew to transfer from internal to external environment without depressurizing the crew compartment. The selected configuration includes a rigid Equipment Lock (EL) and an inflatable Crew Lock (CL).

The rigid EL hosts EMUs (Extravehicular Mobility Units), E-MMUs<sup>†</sup> (Enhanced Manned Manoeuvring Units), FSS (Flight Support Station), Don/Doff Assembly, EVA toolboxes and batteries. It was sized in order to guarantee the stowage, the servicing and the checkout of the EVA systems, and to deal with any contingency situations.

EL is composed of a cylindrical part, having a diameter of 2.3m and a length of 1.5m and two cones ending with two hatches dividing it from the HAB, on one extremity, and from the CL, on the other side. Accordingly to NASA-STD-3000 [6], the two EL hatches have a diameter of 0.8m (for the hatch dividing it from the HAB) and of 0.9m (for the hatch between it and the CL). The thickness of the shell is 2.16mm, sized considering as material Al 2219-T851 and a design pressure of 182kPa.

The second part composing the airlock is the inflatable Crew Lock, which is depressurized to vacuum in order to allow the astronauts to exit from the spacecraft, through the EVA hatch, and start their spacewalk. CL shape is an oblate spheroid, made of various fabrics of Aluminium, with a length of 2.44m and a height of 2.13m, and having a volume of 1.6m<sup>3</sup>, which becomes 6.4m<sup>3</sup> when deployed.

The main topics studied in the design of CL are [8]:

- The Gas recovery system.
- The Pressurization System, which is composed of three separate subsystems: internal pressure control S/S, Air beams pressure control S/S and Pneumatic muscles control S/S.
- The Retraction System for which the use of telescoping (motor-driven) mechanisms was envisaged.

A sketch of the airlock final configuration is shown in Fig.8.



Fig. 8: Airlock

### Environmental Protection

When travelling into space different kinds of hazards can cause more or less dangerous effects on the spacecraft and, most of all, on the crew. The most significant risks caused by space environment are due to the meteoroids and debris environment and to the high-energy radiation of galactic cosmic rays, solar particle events, radiation belts.

<sup>†</sup> Enhanced Manned Maneuvering Units are foreseen to allow astronauts mobility on the surface while in EVA, due to the very limited gravity of the asteroid.

Therefore a dedicated protection subsystem needs to be implemented for both the crew living module and the airlock.

The impact of the spacecraft with micrometeoroid and orbital debris (MMOD) can lead to degradation of performances or in the worst case to catastrophic loss of the vehicle. Therefore, an appropriate MMOD protection has to be envisaged for ensuring safe and successful operations of the spacecraft.

The design of MMOD protection started from the characterization of the environment the spacecraft has to withstand during its mission and the assessment of the requirements. Two specific models were taken as reference for MMOD environment characterization (NASA90 model [18] and the NASA tool ORDEM2000 [19]) and a trade-off was performed to choose the most suitable configuration among three different possibilities, as shown in Fig.9.

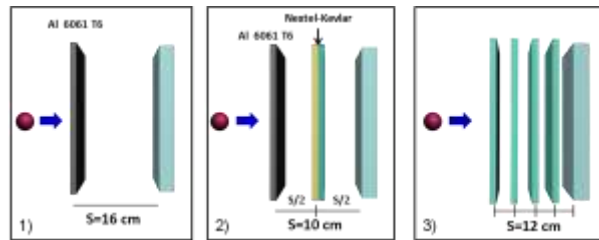

Fig. 9: MMOD protection possible alternatives. 1) Whipple Shield; 2) Stuffed Whipple Shield; 3) Multi Shock Shield.

The chosen solution is the Whipple Shield in which the rear wall coincides with the shell of the primary structure, the bumper is made of Aluminium Al 6061-T6 and has a thickness of 1.3mm, and the stand off distance is 16cm.

The second very critical aspect due to external environment is represented by space radiations.

Once outside the protection of the Van Allen Belts the astronauts are constantly exposed to galactic cosmic rays (GCR), which deliver to human body a steady dose. The intensity of the GCR flux varies over the 11-year solar cycle and the maximum dose received occurs at solar minimum. In addition to the GCR, for long duration mission it must be considered the case in which a solar flare takes place. Large solar proton events are relatively rare, usually one or two events per solar cycle, but they could be very dangerous if the spacecraft is inadequately shielded since they deliver a very high dose in a short period of time.

For AENEA mission the protection provided by structure and racks/equipment was evaluated sufficient as protection against GCR. An equivalent area density of  $15\text{g/m}^2$  of Aluminium was assumed, which corresponds to about 20 cSv/year for GCR at solar maximum and about 40cSv/y for GCR at solar minimum [20]. This means that the total dose is within the allowable limits imposed by NASA ( $50\text{cSv/y}^{\ddagger}$ ) [10].

On the contrary, a dedicated shelter is mandatory as protection against SPE, since without it the dose in case of a SPE occurrence would exceed the allowed limits. The material chosen for the shelter is polyethylene, since it has a high content of hydrogen, which is highly effective for protecting against radiations. Furthermore, polyethylene is readily available, non-toxic, and chemically stable under typical conditions.

A trade-off was performed to evaluate the best solution for the positioning of the Radiation Shelter. In particular five different possible locations were identified: the compartment zone, the crew quarters zone, the passage way, the equipment lock or the command module. Furthermore, the possibility to utilize specific protection suits in addition to the shelter was considered. These alternative possibilities were compared taking as reference a radiation environment equivalent to that produced by AUGUST72 SPE and GCR at solar maximum [9]. In order to guarantee that the absorbed dose is maintained below the allowable limits [9], an overall area density of  $25\text{g/cm}^2$  of Polyethylene equivalent<sup>§</sup> was considered. To guarantee this area density the required Polyethylene thickness is about 14cm (density  $\rho=0.96\text{g/cm}^3$ ). The masses and volumes obtained for all the considered solutions are reported in Table 2.

Architecture	Thickness <sup>2</sup> [g/cm <sup>2</sup> ]	Mass [MT]	Volume shielded [m <sup>3</sup> ]	Habitable Volume [m <sup>3</sup> ]
Compartment + Suit	25	14.3	46	40
Crew Quarters + Suit	25	10.9	25	14

<sup>‡</sup> Reference mean value

<sup>§</sup> Considering the assumed  $15\text{g/cm}^2$  of aluminium equivalent provided by structure/equipment (which corresponds to about  $12\text{g/cm}^2$  of Polyethylene equivalent), the Polyethylene shelter must provide additional  $13\text{g/cm}^2$ .

Passage Way	25	4.0	5	5
Passage Way + Suit	25	3.1	5	5
Equipment Lock	25	4.0	6	5
Equipment Lock + Suit	25	3.2	6	5
Command Module	25	6.8	33	10

Table 2: Radiation Shelter Trade-Off

Finally, the configuration that implies the lowest mass was selected, that is the one envisaging a shelter, located in the passage way through the compartment zone (see Fig.10), and a radiation suit made of the same material (high density polyethylene) to protect the most sensible parts of the body (see Fig.11).

For the selected solution the shelter has a height of 3m and a side 1.6m, which imply about 5m<sup>3</sup> of habitable volume.



Fig. 10: Shelter position: the shelter is allocated in the Passage Way through the compartments zone.

Part of the shelter volume can be utilized for functional purpose, i.e. for stowage of items and tools needed for the activities to be performed by the astronauts.

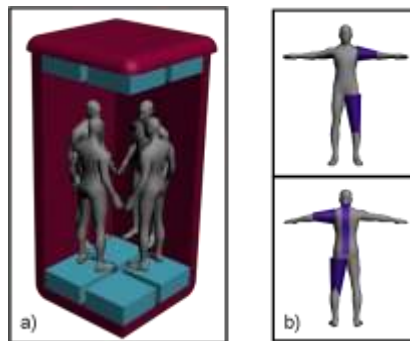

Fig. 11: a) Shelter configuration; b) Radiation Suits

Three configurations are envisaged, as shown in Fig.12: Normal Configuration, in which the astronauts can be standing over the storage units placed on the longitudinal sides of the shelter, Activity Configuration, in which the astronauts are in a sitting position, Sleeping Configuration, in which a personal volume of 1 cubic meter is allocated for each astronaut through a deployable curtain system.

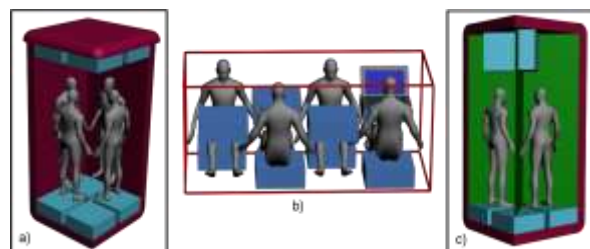

Fig. 12: Shelter configurations: a) Normal Configuration; b) Working Configuration; c) Sleeping Configuration

The Environmental Control and Life Support System (ECLSS) deals with the physical, chemical and biological functions and is in charge of providing crew members with suitable environmental conditions. In particular, it is envisioned to maintain a controlled environment, provide resources, manage wastes and respond to environmental contingencies.

For the HAB a Partially Closed Loop was envisioned, which is characterized by Physico-Chemical technology: Potable, Hygiene and Urine water recycle; Oxygen production; stored Food.

Fig.13 shows the functional interfaces among the main elements composing the ECLSS.

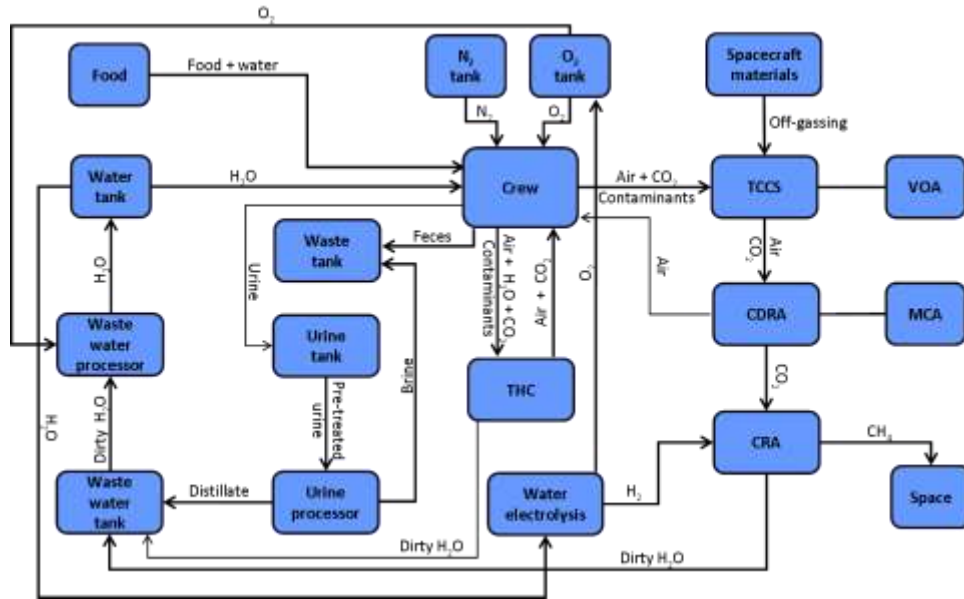

Fig. 13: ECLSS schematic functional layout

An important step in the design of ECLSS was the selection of the atmosphere, for the spacecraft and for the space suits. This is crucial since it influences many aspects of the design, operations and technology development. To select the atmosphere some working bounds were established according to the specific requirements about the respiratory physiology (normoxic and hypoxic boundaries), the decompression sickness prevention and the selection of the materials (due to flammability reasons), within which the atmosphere shall be included.

Some working bounds were established on the spacecraft cabin atmosphere pressure and oxygen concentration to identify the design space according to specific requirements about respiratory physiology (Normoxic and hypoxic boundaries), decompression sickness prevention and materials selection (due to flammability reasons).

Fig.14 highlights the spacecraft cabin atmosphere design space for a 29.6 kPa space suit with a maximum tissue ratio of 1.4 for nominal EVA (the space suit internal atmosphere is assumed to be 100% oxygen).

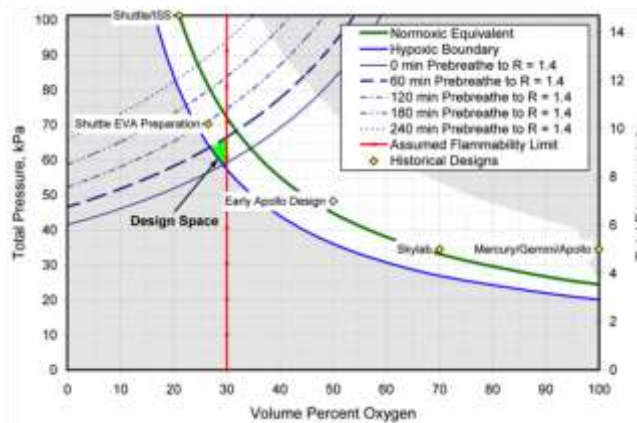

Fig. 14: ECLSS schematic functional layout

Table 3 reports the details of the atmosphere selected for both the cabin and the EVA suits [11]. In particular two different operative cabin pressures are envisaged during the mission and space suits able to work at variable pressures are considered. This solution allows to meet the requirements, for NEA operations phase, about the maximum pre-breathing time, which shall not exceed 60 minutes, and about the suits manoeuvrability, which imposes a working pressure of 29.6kPa, and to minimize the pre-breathing time in case of contingency EVAs. As a matter of fact, if the suits were not designed to work at different pressures, but only at the conventional pressure of 29.6kPa, in case of a contingency EVA during the flight, the pre-breathing time would be more than 3 hours.

	Cabin Pressure [kPa]	Cabin O <sub>2</sub> vol. Concentration [%]	EVA suit pressure [kPa]	EVA pre-breathe time [min]
Flight	91.0	23.1	41.4	0
NEA ops	64.0	26.8	29.6	60

Table 3: Atmosphere selected for Cabin and EVA Suits

Thermal Control System

A schematic view of the architecture of the thermal control system, necessary for the habitation module, is shown in Fig.15. The picture also highlights the contributions to the thermal budget that mainly come from the solar irradiation, ECLSS and internal heat production, which is related to equipment, crew, racks, etc.

The internal heat is collected by means of internal loops, using water as transporting fluid, and is transported toward an external loop, which instead uses ammonia. This loop is in charge of collecting both the heat coming from the internal of the HAB and the heat coming from the external appendices. The internal and the external TCS are linked by means of interface heat exchangers, which utilizing a counter-flow design [*“Active Thermal Control System (ATCS) Overview”*, Boeing]. Finally all collected heat is rejected towards the external free space by means of radiators.

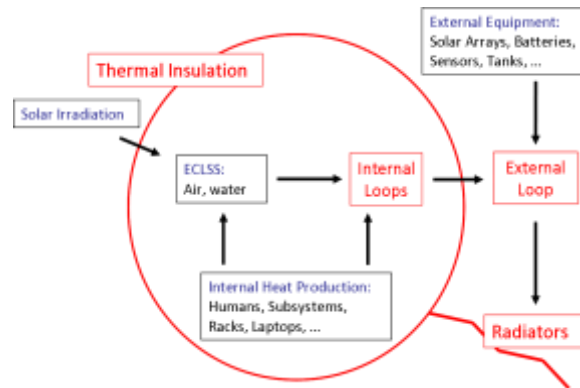

Fig. 15: Thermal Control System: in red the composing parts of the TCS are indicated.

Furthermore, HAB must be insulated from the external environment, in particular from the solar irradiation, which has a great effect on the increase of the temperature. For the design of the thermal insulation different scenarios were considered, since the contributions on the spacecraft vary depending on the mission phases. In particular, three different scenarios can be considered:

- the spacecraft has one side directly exposed to the sun irradiation, while the other side is exposed to the Earth's infrared radiation and to the Earth's albedo, that happens during the LEO phase;
- the spacecraft is shadowed by the TM, that should be the nominal flight configuration;

- the S/C is exposed for half of its total envelope to the sun irradiation and the other half in shadow, that is the worst case in terms of temperature gradients.

The Multi Layer Insulation (MLI) adopted to maintain the temperature within acceptable values, is composed of 20 layers of Aluminized Kapton, with Dacron net as separators, which allows for an effective emissivity of 0.003 and is interposed between the external bumper and the internal shell (both made of Aluminium) [12]. The external surface is coated such that it is characterized by an absorptivity of  $\alpha = 0.318$  and an emissivity of  $\epsilon = 0.445$ .

The MLI covers all the external surface of the HAB and is divided into 12 panels of 7m×1.3m. Between two adjacent panels, stiffeners are interposed. The heat transfer coefficient associated to the stiffeners is 0.12 W/K per panel. With these characteristics the temperatures of the parts composing the insulation were computed for the different scenarios. The results are reported in the table 4.

		Temperatures [°C]			
		Bumper	MLI Outer layer	MLI Inner Layer	Shell
Sunlight	@ 0.8 AU	16 ÷ 128	16 ÷ 124	18 ÷ 35	18
	@ 1 AU	-14 ÷ 86	-12 ÷ 83	15 ÷ 27	18
	@ 1.2 AU	-36 ÷ 54	-32 ÷ 53	14 ÷ 22	18
Earth	@ 300 km	-51 ÷ 34	-45 ÷ 33	13 ÷ 20	18
Shadow	-	-163	-122	10	18

Table 4: Insulation Temperatures

Moreover, in order to ensure that the shell temperature is maintained above the Dew point, heaters are provided.

The second element composing the TCS is the Active Thermal Control System (ATCS), which aims at maintaining the equipment within an allowable temperature range by actively collecting, transporting, and rejecting waste heat into the external space. The internal heat production is essentially associated to two different contributions:

- the crew metabolic heat, which depends on level of work: in order to be conservative, all the four crew members performing heavy work activities is considered as design reference value, that corresponds to almost 1 kW;
- the heat produced by internal equipment, which amounts to about 14 kW as shown in Table 5.

Sub-system	Nominal Power Dissipation [kW]
TCS	0.5
ECLSS	5.0
C&DH	2.0
Crew Systems	2.4
Communications	0.5
Structures & Mechanisms	0.1
Payload Support	1.0
Total Power	11.5
Harness Losses	2.3
TOTAL	≈14

Table 5: Power Budget (Nominal Operational Mode)

The heat collected is finally rejected towards the external space by means of two radiators wings; in particular the area required to reject the design reference 15kW was computed through the following equation: [14]

$$Q = \eta \epsilon \sigma A_R (T_R^4 - T_{ext}^4)$$

where

- $\eta$  is radiator efficiency (assumed  $\eta = 0.90$ );
- $\epsilon$  is the radiator emissivity (assumed  $\epsilon = 0.92$ );
- $\sigma$  is the Stephan-Boltzmann constant ( $\sigma = 5.67E-8 \text{ W}/(\text{m}^2\text{K}^4)$ );
- $T_R$  is the average radiator temperature (assumed  $T_R = 10^\circ\text{C}$ ).

The so computed radiators area amounts to about 50 m<sup>2</sup>. In particular two wings capable of rejecting from both sides and composed of three panels each are envisaged. Each panel has size of 10m×0.5m, so that 5 panels are sufficient to provide the required rejection area, while the sixth panel is included for redundancy.

### Electrical Power System



The electrical power system must be able to provide all other on-board subsystems with the power required in different operational modes during the entire mission.

It is composed of three major elements: the primary power source, the power management and distribution (PMAD) unit and the storage system. Fig.16 shows how they interact among them and with the loads that have to be provided with power. As primary power source solar arrays are adopted, which are capable to satisfy the average power demand. As storage system, secondary batteries are provided, which are in charge of facing the eclipse conditions and satisfying the peak demand.

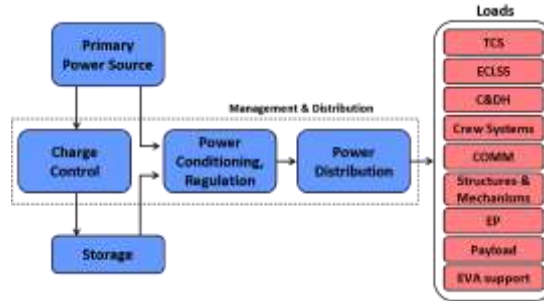

Fig. 16: Electrical Power System functional layout

The required power that has to be provided depends on the operational modes in which the spacecraft is working during the different phases of the mission, as shown in Table 6.

Subsystem	POWER DEMAND [kW]						
	Operational Mode						
	Nominal	LEO check	Safe	SPE	EVA	Night	Stand-by
TCS	0.50	0.20	0.20	0.20	0.50	0.40	0.03
ECLSS	5.00	3.30	3.30	5.00	4.00	5.00	0.25
C&DH	2.00	1.50	1.50	1.50	2.00	1.50	0.10
Crew Systems	2.40	0.80	0.80	0.80	0.80	0.80	0.12
Communications	0.50	0.50	0.00	0.00	0.50	0.00	0.03
Structures & Mechanisms	0.10	0.10	0.00	0.10	0.10	0.10	0.01
Environmental Protection	0.00	0.00	0.00	0.00	0.00	0.00	0.00
Payloads Support	1.00	0.05	0.05	0.05	1.00	1.00	0.05
EVA support	0.00	0.00	0.00	0.00	1.00	0.00	0.00
Total power	11.50	6.50	5.90	7.70	9.90	8.80	0.58
System Margin	20.00%	20.00%	20.00%	20.00%	20.00%	20.00%	20.00%
TOTAL	13.80	7.90	7.10	9.30	11.90	10.50	0.70

Table 6: Power Demand for the different operational modes

The most demanding operational mode is the nominal one, in which the average required power amounts to almost 14 kW. In nominal conditions all subsystems are fully operational, except for EVA support subsystem, which works only if an EVA has to be performed. In all the other operational modes the subsystems work at a reduced power level.

The solar arrays sizing [7] was performed considering the power demand profile of the LEO system check phase, since this phase includes a certain eclipse time, during which the batteries are in charge of providing the needed power. This must be the reference profile since, in this operational mode, the solar arrays have to guarantee the average required power (about 8kW) as well as the power necessary for recharging the batteries.

The power required to be provided by solar arrays during daylight is computed as:

$$P_{SA} = \frac{\left( \frac{P_e T_e}{X_e} + \frac{P_d T_d}{X_d} \right)}{T_d}$$

where

- $P_e$  and  $P_d$  are the spacecraft's power requirements during eclipse and daylight, respectively (7.9kW are required both in daylight and eclipse condition during the LEO system check phase);
- $T_e$  and  $T_d$  are eclipse and daylight periods per orbit, respectively (eclipse duration assumed equal to daylight time);



- $X_e$  and  $X_d$  represent the transmission efficiencies for eclipse and daylight conditions, respectively (efficiencies of 78%\*\* and 85% are assumed for eclipse and daylight conditions respectively).

The solar arrays area ( $A_{SA}$ ) was computed by means of [14]:

$$A_{SA} = \frac{P_{SA}}{P_{EOL}}$$

where  $P_{EOL}$  represents the arrays performance per unit area at the end-of-life. It is evaluated as:

$$P_{EOL} = P_{BOL} L_D$$

where

- $P_{BOL}$  represents the arrays power per unit area at the beginning-of-life (BOL), computed as  $P_{BOL} = P_0 I_d \cos \theta$ , where  $P_0$  is the ideal power per unit area at BOL,  $I_d$  is the inherent degradation (including inefficiencies due to assembly, temperature and shadowing) and  $\cos \theta$  is the cosine loss;

- $L_D$  is the life degradation expressed as  $L_D = \left(1 - \frac{\text{degradation}}{\text{year}}\right)^{\text{lifetime}}$ .

$P_0$  was computed considering BTJ Photovoltaic Cells [Triple-Junction Solar Cell for Space Applications datasheet by Emcore Corporation], which have an efficiency of 28.5%, and taking into consideration that the maximum distance from the Sun is 1.05AU.

The resulting required area is about 71 m<sup>2</sup>, which is divided into two wings, each composed of two blankets. Flexible blankets are adopted since they are convenient in terms of mass with respect to the rigid ones; they are deployed by means of a FASTMast deployer [13].

As storage system, Li-ion secondary batteries were adopted, since they have the best energy-to-mass ratios and a very slow loss of charge when not in use. The main characteristics of the adopted batteries are:

- a discharge efficiency ( $E_d$ ) of 96%;
- a depth of discharge (DOD) of 80%;
- a specific energy of 175Wh/kg.

With these parameters the minimum required capacity for battery was computed as:

$$C_r = \frac{P_g T_g}{DOD E_d}$$

and it amounts to about 7.7kWh.

The adopted batteries are *SAFT Batteries* (rechargeable lithium battery VES 180 – Very high specific energy space cell), which have a nominal voltage of 3.6V and a nominal capacity of 50Ah, that means a nominal energy of 180Wh.

For the batteries assembly, a working voltage of 100V was assumed, that is a good compromise in order to have a quite high value and reduce the dissipation due to the Joule effect, without an excessive increasing of the mass.

Therefore, to satisfy the requirements, both in terms of total power and voltage, a stack composed of 28 batteries in series for ensuring the right voltage and 2 strings in parallel, for guaranteeing the right total power, was adopted.

With this arrangement of the batteries the total capacity that is possible to be achieved is 10kWh, allowing also to provide the required 2 failures tolerance.

### Communications

The communications system must guarantee communications between the astronauts, the S/C and the Earth allowing accurate TT&C, storage and transmission of scientific data and multimedia broadcast to the Earth.

The communications system is necessary for guaranteeing different types of communications along the entire mission. In particular, it shall provide:

- communications between the spacecraft and the ground station,
- communications between the spacecraft and the astronauts in EVA,
- communications between the spacecraft and the payload released on the asteroid surface,
- communications between the astronauts in EVA.

The data that the system shall be able to transmit consist of TT&C and voice, video both for internal videoconference and from EVA helmet cameras, biometric monitoring and check data, spacecraft monitoring engineering data, and scientific data.

---

\*\* This value derives from the daylight one scaled according to the batteries charge and discharge efficiencies, as they affect the power transmission during eclipse conditions.

The system architecture includes the links necessary to guarantee internal, short range and long range communications. In particular for the internal communications an optical fibre network was selected. For the short range communications, which allow astronauts in EVA to communicate between themselves and with the astronauts on the spacecraft, as well as the communication between the spacecraft and the payload on the asteroid surface, a 3GPP-like technology was considered. This technology allows 100Mbps in download using SISO transmission, and 50Mbps in uplink.

For the long range communications four different scenarios were traded, as shown in Fig.17. All the considered configurations include a direct S-band link, for safety reasons, able to transmit telemetry and voice data with low power consumption. .

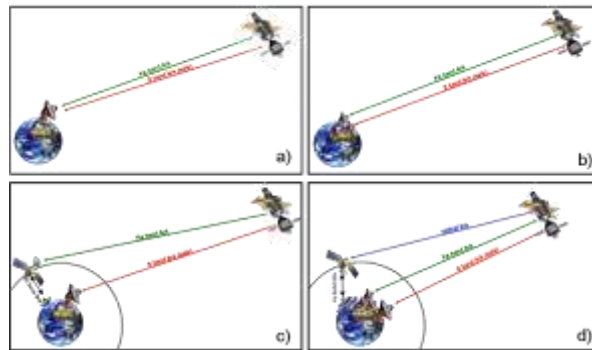

Fig. 17: Communications network possible configurations.

- a) Direct Ka-band transmission between S/C and NASA Deep Space Network (DSN) on ground;
- b) Direct Ka-band transmission between S/C and dedicated network on ground;
- c) Ka-band link between S/C and GEO satellite, transmitting in Ku-band to ground station;
- d) optical link between S/C and GEO satellite + direct Ka-band transmission between S/C and ground station.

Some analyses and trade-offs [7], [15], [16] were carried out in order to decide if RF or optical transmission is preferable and what is more convenient between relying on DSN and having a dedicated network [*Viscio et Al. "AENEA Report: Project Work - Phase I", July 2010, unpublished results*]. As a result of the performed analyses the configuration that was adopted foresees:

- an antenna of 1m diameter transmitting through an S-band link between the spacecraft and the DSN, as a safe communications link,
- 2 antennas (one is for redundancy reasons) of 3m diameter transmitting through the Ka-band link between the spacecraft and a dedicated network with 18m diameter antennas,
- one telescope with a diameter of 35cm transmitting to the Geo-stationary satellite,
- the data are transmitted in Ku-band from the satellite to a second dedicated network with 4m diameter antennas.

The optical link was introduced as additional backup solution, due to data storage capability by exploiting the satellite, and for technology test reason. As matter of fact one of the objectives of the AENEA mission is the test of new technologies that could be useful for further targets' exploration missions.

The results described above were obtained considering the maximum distance between Earth and the spacecraft of 0.2 AU.

### Crew Systems

The Crew Systems can be defined as all the subsystems that directly interface with the astronauts during the daily activities. They represent the most part of the internal subsystems and include the following facilities:

- Crew quarters
- Personal hygiene
- Body waste collection
- Medical facility

- Maintenance systems
- Meeting room
- Housekeeping
- Kitchen
- Food stowage
- Physical exercises

All the subsystems and crew systems are allocated in the HAB, which is internally divided into (see Fig.18):

- 8 compartments, envisaged also to provide the crewmembers with private rooms and having a volume of  $4.4 \text{ m}^3$  (with length of 1.5m and side of 1.6m);
- 16 racks, similar to those used on the ISS, having a volume of  $2.2 \text{ m}^3$  (with length of 1m and side of 2.2m);
- 4 stand-offs, which are the “corner” empty zones mainly used for the passage of cables, pipes and harness; each stand-off has a volume of  $4 \text{ m}^3$ .

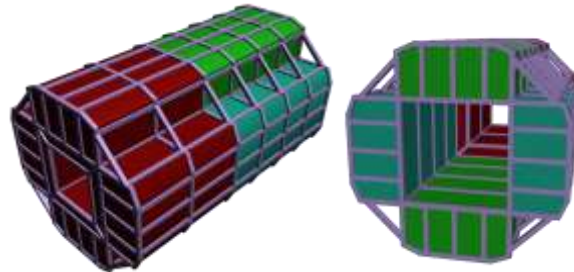

Fig. 18: HAB internal configuration: the red structures represent the compartments, while the green and cyan are the racks. They are all connected to the secondary structure.

Each astronaut has his/her own crew quarter which provides a quiet and isolated environment, thanks to acoustic noise mitigation, sleep accommodation and restraints, lighting, ventilation and temperature control, personal laptop and communications systems, personal items (books, games, ...).

The personal hygiene facility, which occupies one of the compartments, is envisaged to allow whole body cleaning, hands and face washing, oral hygiene, shaving, hair brushing and cutting, water isolation and privacy. Due to the long duration of the mission, a shower is included allowing each astronaut to take a shower every 4 days.

The body waste collection facility is in charge of collecting waste and providing cleaning. It is located in one of the compartments.

The medical facility is needed for crew health monitoring and checking, medical prevention and diagnosis, as well as to manage injuries, or for surgical interventions. It is allocated in one of the compartments.

The last compartment is occupied by the maintenance systems, providing at the same time spare parts stowage and a repairing and testing workstation. In this respect it allows equipment failures identification and elements removing, diagnostic, replacing, failed elements repairing and testing.

The meeting room is used for several activities of the crew, such as meals serving and consuming, mission planning and verification, meetings, recreational activities, multimedia communications and external window observation.

The Housekeeping facility, located in one of the racks, is needed to guarantee internal surfaces cleaning and trash collection and managing. It hosts 3 vacuum cleaners and half of the disposable wipes.

The Kitchen rack is the area intended for food preparation and cooking; it hosts all the equipment for cooking, the dishwasher and the other half of the disposable wipes. Three racks are necessary for the stowage of the food needed by the 4 astronauts along the entire mission. The Food Stowage facility is equipped with freezer for food preservation.

Another rack is intended for clothes stowage and laundering (washing/drying). Due to the long duration of the mission 12 complete changes for each crewmember and washing and drying machines are envisaged, since this solution, in terms of mass, is more convenient than bringing clean clothes for 6 months.

Finally, the physical exercise facility is needed in order to face the effects of microgravity on the human body. Two racks host the physical exercises equipment. Astronauts are required to exercise at least 2 hours per day, and

during the training they have the possibility to watch TV or listen to music. Moreover, a virtual reality toolbox is introduced here, useful to make astronauts train for the extra vehicular activities around the asteroid.

Fig.19 shows the functional allocation of each compartment and of each rack. In the cones the tanks of water (blue), oxygen (light blue) and nitrogen (grey) are allocated.

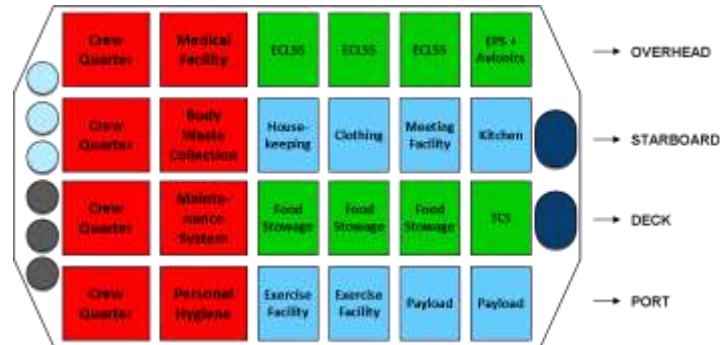

Fig. 19: HAB internal functional allocation: the red structures represent the compartments, while the green and cyan are the racks.

### EVA Support System

Several elements are needed during the phase of operations in EVA around the asteroid, which represent the core of the AENEA mission. The most important are the space suits, the E-MMU, FSS, tethers and other tools.

The E-MMUs are stowed on the external side of the EL of the airlock attached to the FSS. The E-MMUs are an evolution of MMU used by NASA for retrieval of satellites [17]. They are operated through separate hand controllers for inputting the pilot's translation and rotation manoeuvre commands to the cold gas thrusters system. Their main features are the following:

- 6 D.O.F. Control Authority
- spacecraft-type Piloting Logic (3-Axis Translational Controller, with Left Hand, 3-Axis Rotational Controller, with Right Hand, Independent or Multiple Axis Commands, Pulse or Continuous Commands)
- Manual Translation and Rotation Control
- Automatic Attitude and Position Hold
- Audio Feedback for Thrusters Operation
- Remote Control and Override Capability from the CM

The E-MMUs are designed to be two failures tolerant, since they have to work in a hostile environment, during one of the most critical phases of the mission, and their failure could compromise the safety of the astronauts. They are provided with three independent systems, composed of 12 thrusters each, for a total number of 36 thrusters; furthermore the control electronics are also redundant. In case of single failure the E-MMU operates in Backup Mode and the astronaut can come back to the spacecraft without any additional problem. In case of double failure the astronaut can come back to the spacecraft in Safe Mode (50% of Nominal Mode efficiency).

### III. RESULTS

For each of the described subsystems the budget in terms of mass, power and volume were derived. In particular Table 7 provides a summary of the obtained results, showing the masses of the subsystems.

The overall mass of the HAB amounts to about 23 tons and hence is compatible with the launcher capability. The masses of all the subsystems were computed according to the design processes described in the previous sections. They all include a specific subsystem margin assigned depending on the level of knowledge of the subsystem. Furthermore, a 20% of system margin was added to the overall mass.

Analogously, the total required power was evaluated including a 20% system margin.

The internal volume allocation was done accordingly to the volumes evaluated for the subsystems equipment, resources and spare systems. The volume provided by each compartment amounts to 4410 litres, while the racks have a maximum volume of 2300 litres each. Four out of eight compartments are intended to allocate the crew

quarters, while the others are occupied by the medical facility, the hygiene facility, the maintenance systems and the waste collection facility.

The utilization of the 16 racks, is as follows:

- three are used to stow the food,
- two are foreseen for the payloads,
- two are occupied by the physical exercises equipment,
- one is used for clothing,
- one for house-keeping facility,
- one for the kitchen,
- one for the meeting facility,
- the remaining ones for the allocation of ECLSS, TCS, EPS and avionics.

				MASS BUDGET [tons]			POWER BUDGET [kW]		
		S/S components mass	S/S mass budget	Total Mass (w/o sys margin)	Total Mass (w/ 20% sys margin)	S/S average power budget	Total Power (w/o sys margin)	Total Power (w/ 20% sys margin)	
<b>Structure and Mechanisms</b>	Shell Mass		0.65	≈3	10%	3.3	0.1		
	Reinforcements		0.18						
	Cone Mass		0.22						
	Hatch		0.05						
	Bulkhead		0.14						
	Window		0.10						
	Docking System		0.30						
	Primary structure		1.64						
	Secondary Internal structure		1.34						
<b>Joint Airlock</b>			0.9	10%	1.0	1			
<b>ECLSS</b>	<b>Dry mass</b>	WMR	0.45	2.2	10%	2.4	5		
		ARS	0.48						
		ACS	0.12						
		THC	0.09						
		FDS	0.05						
		WM	0.03						
		Spares	0.38						
	<b>Resources</b>	Oxygen	0.08						
		Nitrogen	0.20						
		Water	0.11						
	Tanks	0.26							
				<b>19</b>		<b>23</b>		<b>11.5</b>	<b>14</b>
<b>Environmental Protection</b>	<b>MMOD</b>	Bumpers Mass	0.52	3.7	10%	4.1	0		
		Supports	0.08						
	<b>Radiation Protection</b>	Radiation Shelter	2.90						
	Radiation Suits	0.20							
<b>Electrical Power System</b>		Solar Arrays	0.25	0.4	10%	0.4	//		
		Batteries Stack	0.06						
		PMAD	0.08						
<b>Thermal Control System</b>		Thermal Insulation (MLI)	0.06	0.8	10%	0.9	0.5		
		ATCS	0.74						
<b>Communications</b>			0.10	0.1	5%	0.1	0.5		
<b>EVA Systems</b>	Suits		0.21	0.8	5%	0.8	0		
	Suit support		0.04						
	E-MMU dry		0.30						
	E-MMU propellant		0.15						
	FSS mass		0.05						
	Tools		0.01						
Tethers		0.01							
<b>Payload</b>			0.6	5%	0.6	1			
<b>Harness &amp; miscellanea</b>			0.2	10%	0.2	1			
<b>Crew Systems</b>			5.5	2%	5.6	2.4			

Table 7: HAB Overall Mass and Power Budgets

The ECLSS system occupies 3 racks and spares are placed in half of the compartment dedicated to the maintenance systems. The small amount of resources, which accounts also for 5 days of emergency supplies, is due to the high closure level of the ECLSS (95% closed). The Avionics, the TCS and the EPS hardware are evaluated to occupy the last two racks. Finally, the volume available in the two cones is used for the resources tanks: two water tanks in one of the cones, three tanks for oxygen and three for nitrogen positioned in the second cone.

#### IV. CONCLUSIONS

This paper has presented a pressurized habitation module intended to host four astronauts during a 6 months exploration mission to a Near Earth Asteroid (AENEA mission). Within the paper the methodology adopted for the design of the module was described, as well as the main obtained results.

HAB is a rigid module with a shape similar to that used for the ISS modules (cylinder with two cones at the extremities) able to provide the astronauts with all the functionalities needed to sustain their life during the space flight towards the asteroid and back. In addition it supports the operations in the proximity of the asteroid and the EVAs of the astronauts on the surface. A mission of this type presents many challenging aspects, due to the environment in which the astronauts have to live and work for such a long period. In this regard, one of the most relevant issues is the long exposure to space radiations, which could produce very serious consequences on human bodies. For this reason a dedicated shelter was introduced in the HAB to face the event of an SPE occurrence. In addition, to further reduce the radiation dose, specific suits made of polyethylene were envisaged. This technology has still a quite low TRL and great effort should be put into improving it.

The core of AENEA mission is represented by the phase of operations around the NEA, including the EVAs that have to be performed by the astronauts. This mission phase is therefore characterized by crucial issues that were necessarily addressed, in order to introduce adequate systems to perform EVA in a safe manner, such as the airlock, the space suits and the E-MMU. All these systems include some not very mature technologies:

- the airlock exploits the inflatable technology, which is still not enough consolidated,
- space suits able to work at different pressures are not yet available, and further investigation could be dedicated to them,
- the E-MMUs as designed for this mission present several differences with already used examples of MMU, and have still a low TRL (estimated TRL 3).

A module as designed is quite versatile module given that specific minor modifications are introduced to respond to a different mission's requirements.

The presented study has highlighted the most critical aspects linked to the habitation module needed to accomplish a human mission to a Near Earth Asteroid, which becomes an even more significant issue in view of the human mission to Mars. The results discussed within the paper could be considered as the first step of an iterative process where to start from for future further investigations.

#### V. ACKNOWLEDGEMENTS

The authors would like to thank all SEEDS V team members who have contributed to the development of the project and all the Academic and Industry Tutors for their supervision and support.

#### VI. LIST OF ACRONYMS

AAA – Avionics Air Assembly  
ACS – Atmosphere Control and Supply  
AENEA – humAn Exploration of a Near Earth Asteroid  
ARS – Air Revitalization and Sampling  
ATCS – Active Thermal Control System  
AU – Astronomical Unit  
CCAA – Common Cabin Air Assembly  
CDRA – Carbon Dioxide Removal Assembly  
CL – Crew Lock  
CLM – Crew Living Module  
CM – Command Module  
CSM – Command and Service Module

DSN – Deep Space Network  
ECLSS – Environmental Control and Life Support System  
EL – Equipment Lock  
E-MMU – Enhanced Manned Manoeuvring Unit  
EMU – Extravehicular Mobility Unit  
EPS – Electrical power System  
EVA – Extra Vehicular Activity  
FDS – Fire Detection and Suppression  
FSS – Flight Support Station  
GCR – Galactic Cosmic Rays  
HAB – Habitation module  
HEFT – Human Exploration Framework Team  
IMV – Inter-module Ventilation  
IVA – Intra Vehicular Activity  
LEO – Low Earth Orbit  
LTL – Low Temperature Loop  
MCA – Major Constituent Analyzer  
MLI – Multi Layer Insulation  
MMOD – Micrometeoroids and Orbital Debris  
MTL – Moderate Temperature Loop  
NASA – National Aeronautics and Space Administration  
NEA – Near Earth Asteroid  
NEO – Near Earth Object  
OGS – Oxygen Generation System  
PMAD – Power Management and Distribution  
RF – Radio Frequency  
S/C – Spacecraft  
SEEDS – SpacE Exploration and Development Systems  
SISO – Single Input Single Output  
SM – Service Module  
SPE – Solar Particle Event  
TCCS – Trace Contaminant Control System  
TCS – Thermal Control System  
THC – Temperature and Humidity Control  
TM – Transportation module  
TRL – Technology Readiness Level  
WM – Waste Management  
WRM – Water Recovery and Management

## VII. REFERENCES

[1] J. Hopkins, A. Dissel, M. Jones, J. Russell, R. Gaza, Plymouth Rock An Early Human Mission to Near Earth Asteroids Using Orion Spacecraft, Lockheed Martin, Version 2.0, June 2010

[2] “HEFT Phase I Closeout”, Steering Council, September 2, 2010.

[3] L. Toups JSC, D. Smitherman MSFC, H. Shyface LaRC, M. Simon LaRC, M. Bobskill LaRC, D.R. Komar LaRC, P. Guirgis JSC, B. Bagdigian MSFC, G. Spexarth JSC, Deep Space Habitat Team: HEFT Phase 2 Efforts.

[4] M.A. Viscio, N. Viola, E. Gargioli, E. Vallerani, Habitable Module for a Deep Space Exploration Mission, 62nd International Astronautical Congress, Cape Town, South Africa, October 2011

[5] M.A. Viscio, N. Viola, E. Gargioli, E. Vallerani, Human Exploration Mission to a Near Earth Asteroid, 62nd International Astronautical Congress, Cape Town, South Africa, October 2011.

[6] NASA-STD 3000 Handbook.

- [7] W. J. Larson, L. K. Pranke, *Human Spaceflight: Mission Analysis and Design*, Space Technology Series, McGraw-Hill Higher Education, 1999.
- [8] A. Campbell, et. al., *Advanced Inflatable Airlock System for EVA*, ICES 2002-01-2314, International Conference on Environmental Systems, Austin, Texas, July 2002.
- [9] F.A. Cucinotta, M. Y. Kim, L. Ren, *Managing Lunar and Mars Mission Radiation Risks*, NASA/TP-2005-213164, 2005.
- [10] F.A. Cucinotta, *Space Radiation Organ Doses for Astronauts on Past and Future Missions*,
- [11] K. E. Lange, A. T. Perka, B. E. Duffield, F. F. Jeng, *Bounding the Spacecraft Atmosphere Design Space for Future Exploration Missions*, NASA/CR—2005–213689, June 2005.
- [12] M.M. Finckenor, D. Dooling, *Multilayer Insulation Material Guidelines*, NASA/TP-1999-209263, April 1999.
- [13] P. A. Jones, B. R. Spence, *Spacecraft Solar Array Technology Trends*
- [14] W. J. Larson, J. R. Wertz, *Space Mission Analysis and Design*, Third Edition, Space Technology Series
- [15] G. Maral, M. Bousquet, Z. Sun, *Satellite Communications Systems: Systems, Techniques and Technology*, 5th Edition, John Wiley and Sons Ltd., 2009.
- [16] K. Wilson, M. Enoch, *Optical Communications for Deep Space Missions*, IEEE Communications Magazine, 2000
- [17] "Manned Maneuvering Unit: Users Guide", Martin Marietta Corp.
- [18] <http://www.spennis.oma.be/help/background/metdeb/metdeb.html#NASA90>
- [19] <http://orbitaldebris.jsc.nasa.gov/model/engrmodel.html>
- [20] <http://ares.jsc.nasa.gov/HumanExplore/Exploration/EXlibrary/DOCS/EIC008.HTML>



## APPENDIX A

In this appendix the details of the trade-offs described in the paper are reported.

For every trade-off the comparison among the different traded options was carried out according to specific driving factors. Each of the factors was given a certain weight in order to take into account how much, in percentage, it contributes to the final evaluation. For each of the parameter, the various options to be traded were compared with each other and a specific mark was assigned depending on their relative importance. In particular, a mark 0 was assigned when two options are equivalent, a mark 1 (or -1) was assigned meaning that the considered option is more advantageous (or more disadvantageous) than the option to which is being compared. The final scores, weighed according to the driving factors, were evaluated to select the best solution.

### HAB structure: rigid vs inflatable

This trade-off is about the choice to adopt a rigid or an inflatable structure for the crew living module.

In order to take into consideration the major advantages and disadvantages of both the configurations, the following driving parameters were used to perform the trade-off (with the respective assigned weights reported in brackets):

- Operational volume over launch volume ratio (35%),
- Architecture complexity (20%)
- Outfitting (20%)
- Industrial heritage (15%)
- Volume over mass ratio (10%)

The comparison results summary is shown in Table A.1.

	Volume / Mass Ratio	Architecture Complexity	Outfitting	Industrial heritage	Operational Volume / Launch Volume Ratio	
Weight [%]	35	20	20	15	10	100
Inflatable CLM	1	-1	-1	-1	1	-10
Rigid CLM	-1	1	1	1	-1	10

Table A.1: HAB structure: rigid vs inflatable

The option to adopt a rigid module resulted to be the most convenient.

### Airlock position

Four different solutions were identified and traded for the positioning of the airlock.

1. Airlock along the axial direction, between the crew living module and the capsule.
2. Airlock along the axial direction, between the crew living module and the transportation module.
3. Airlock along the radial direction, having a rigid structure.
4. Airlock along the axial direction, having an inflatable structure.

In order to take into consideration the major advantages and disadvantages of all the configurations, the following driving parameters were used to perform the trade-off (with the respective assigned weights reported in brackets):

- structural complexity (50%),
- architecture complexity (30%),
- operational complexity (20%).

The comparison results summary is shown in Table A.2.

	Structural Complexity	Architecture Complexity	Operational Complexity	
Weight [%]	50	30	20	100
Case 1	1	0	1	70
Case 2	3	2	3	270
Case 3	-3	-2	-3	-270
Case 4	0	-2	0	-60

Table A.2: Airlock positioning

The second option, foreseeing the airlock positioned along the axial direction between the crew living module and the transportation module, resulted to be the most convenient.

Airlock structure: rigid vs inflatable

This trade-off is about the configuration to be used for the airlock. The airlock is envisioned to comprise two independent compartments: an Equipment Lock (EL) and a Crew Lock (CL). Six possible configurations were identified:

1. the EL integrated with the HAB and a rigid CL;
2. the EL integrated with the HAB and an inflatable CL;
3. a unique rigid module including both the EL and the CL, which are separate internally by means of a bulkhead;
4. a unique inflatable module including both the EL and the CL, which are separate internally by means of a bulkhead;
5. independent rigid EL and rigid CL;
6. independent rigid EL and inflatable CL.

As for the trade-off about the HAB primary structure, in order to take into consideration the major advantages and disadvantages of the various configurations, the following driving parameters were used to perform the trade-off (with the respective assigned weights reported in brackets):

- o Volume over mass ratio (10%)
- o Industrial heritage (15%)
- o Architecture complexity (20%)
- o Outfitting (20%)
- o Operational volume over launch volume ratio (35%)

The comparison results summary is shown in Table A.3.

	Volume / Mass Ratio	Architecture Complexity	Outfitting	Industrial heritage	Operational Volume / Launch Volume Ratio	
Weight [%]	35	20	20	15	10	100
Option 1	-5	5	1	3	0	-10
Option 2	-3	3	1	-2	0	-55
Option 3	0	1	1	3	0	85
Option 4	3	-5	-5	-5	0	-170
Option 5	0	-1	1	3	0	45
Option 6	5	-3	1	-2	0	105

Table A.3: Airlock structure

The last option foreseeing a rigid EL and an inflatable CL resulted to be the most convenient.

Radiation shielding: passive vs active

This trade-off is about the approach to be adopted to shield the astronauts against space radiations. The option of passive shielding vs active one was traded considering the following driving parameters (with the respective assigned weights reported in brackets):

- o mass (40%),
- o reliability and implications on safety (30%),
- o architecture complexity (20%),
- o impact on other subsystems (10%).

The comparison results summary is shown in Table A.4.

	mass	Reliability / safety	architecture Complexity	Impact on other S/Ss	
Weight [%]	40	30	20	10	100
Active	1	-1	-1	-1	-20
Passive	-1	1	1	1	20

Table A.4: Radiation Shielding

The approach of implementing a passive radiation protection system resulted to be the most convenient.