

Recent Results From the EU POF-PLUS Project: Multi-Gigabit Transmission Over 1 mm Core Diameter Plastic Optical Fibers

Original

Recent Results From the EU POF-PLUS Project: Multi-Gigabit Transmission Over 1 mm Core Diameter Plastic Optical Fibers / Okonkwo, C.M., Tangdionga, E., Yang, H., Visani, D., Loquai, S., Kruglov, R., Charbonnier, B., Ouzzif, M., Greiss, I., Ziemann, O., Gaudino, R., Koonen, A.M.J.. - In: JOURNAL OF LIGHTWAVE TECHNOLOGY. - ISSN 0733-8724. - STAMPA. - 29:2(2011), pp. 186-193. [10.1109/JLT.2010.2096199]

Availability:

This version is available at: 11583/2491298 since:

Publisher:

IEEE

Published

DOI:10.1109/JLT.2010.2096199

Terms of use:

This article is made available under terms and conditions as specified in the corresponding bibliographic description in the repository

Publisher copyright

(Article begins on next page)

Recent Results From the EU POF-PLUS Project: Multi-Gigabit Transmission Over 1 mm Core Diameter Plastic Optical Fibers

C. M. Okonkwo, *Member, IEEE*, E. Tangdionga, *Member, IEEE*, H. Yang, *Student Member, IEEE*, D. Visani, *Student Member, IEEE*, S. Loquai, R. Kruglov, B. Charbonnier, M. Ouzzif, I. Greiss, *Senior Member, IEEE*, O. Ziemann, R. Gaudino, *Senior Member, IEEE*, and A. M. J. Koonen, *Fellow, IEEE, Member*

Abstract—Recent activity to achieve multi-gigabit transmission over 1 mm core diameter graded-index and step-index plastic optical fibers for distances up to 50 meters is reported in this paper. By employing a simple intensity-modulated direct-detection system with pulse amplitude or digital multi-tone modulation techniques, low-cost transceivers and easy to install large-core POFs, it is demonstrated that multi-gigabit transmission up to 10 Gbit/s over 1-mm core diameter POF infrastructure is feasible. The results presented in this paper were obtained in the EU FP7 POF-PLUS project, which focused on applications in different scenarios, such as in next-generation in-building residential networks and in datacom applications.

Index Terms—In-building networks, orthogonal frequency division multiplexing, plastic optical fibers, pulse-amplitude modulation.

I. INTRODUCTION

THE commercialization of polymethylmetacrylate (PMMA) plastic optical fibers (POFs) with large core diameters of 1 mm for providing in excess of 1 Gbit/s has gathered pace in short-range in-building networks and, potentially, in other areas such as in datacom applications for enterprise networking and in emerging applications, such as in board-to-board high-speed interconnects and fiber-to-the-display. Primarily due to the ‘do-it-yourself’ installation, easy maintenance and high bending tolerance, these large core fibers

are considered more suitable than 50 μm core diameter multi-mode glass fibers or perfluorinated plastic optical fibers in some applications. In tandem, to facilitate the use of these fibers, the development and commercialization of low-cost transceivers at visible wavelengths provides a complete cost-effective solution.

In the last 2–3 years, there has been growing research activity to demonstrate 1 Gbit/s transmission over a target distance of 50 meters, for home networking applications. As an example from literature, recent results have demonstrated 1 Gbit/s transmission using a low-cost DVD laser over 100 m step index (SI) POF using adaptive sub-carrier multiplexing [1]. Similarly, by employing adaptive equalization such as feed-forward equalization (FFE), and decision-feedback equalization, (DFE), 1.25 Gbit/s transmission has been shown over 50 meters [2].

As shown by recent transmission records, the research focus is moving towards multi-gigabit. Transmission records achieved using a plethora of POF transmission media in combination with discrete multi-tone (DMT) modulation are cited as follows: 47.4 Gbit/s transmission over 100 m perfluorinated graded-index POF (core diameter 50 μm) using high-performance and high-cost infrared transceiver [3]. Focusing on 1-mm core diameter POFs and by exploiting the DMT technique recent results include; 6 Gbit/s transmissions at visible lights over 35 m of graded-index POF (core diameter 1 mm) [4] and 10 Gbit/s over 25 m of step-index POF (core diameter 1 mm) using high power laser [5]. Other transmission systems achieving 7.5 Gbit/s and 1.62 Gbit/s have also been reported for 5 and 100 m SI-POF lengths using 600 μm diameter Si-PIN photodiodes [6], [7].

By employing 4-level pulse amplitude modulation (4-PAM) the transmission rate of 10 Gbit/s over 300 m of perfluorinated graded-index POF (core diameter 50 μm) was demonstrated in [8]. Based on 1 mm core diameter SI-POF, 1.25 Gbit/s was achieved over up to 75 m using pre-distorted PAM-4 [9]. In both of the PAM transmission records, fractionally-spaced adaptive equalization was required to achieve these results at target bit error rate (BER). Starting from these results and within the context of the POF-PLUS (“Plastic Optical Fiber for Pervasive Low-cost System”) project, the enabling technologies to support the transmission of higher bit-rates towards 10 Gbit/s are investigated in this paper. In particular, we are interested in exploring techniques to achieve multi-gigabit transmission over 1 mm core diameter POF.

Manuscript received July 29, 2010; revised October 20, 2010, November 09, 2010; accepted November 15, 2010. Date of publication December 03, 2010; date of current version January 12, 2011. This work was supported by EU program FP7 ICT-224521 POF-PLUS.

C. M. Okonkwo, E. Tangdionga, H. Yang, D. Visani, and A. M. J. Koonen, are with the COBRA Research Institute, Technical University of Eindhoven, 5600MB Eindhoven, the Netherlands (e-mail: (c.m.okonkwo@tue.nl; e.tangdionga@tue.nl; h.yang1@tue.nl; d.visani@tue.nl; a.m.j.koonen@tue.nl).

S. Loquai, R. Kruglov, and O. Ziemann are with POF Application Center, D-90489 Nuremberg, Germany (e-mail: (sven.loquai;roman.kruglov;olaf.Ziemann)@pofac.ohm-hochschule.de).

B. Charbonnier and M. Ouzzif are with France Telecom, 22307 Lannion, France (e-mail: (benoit.charbonnier, meryem.ouzzif)@orange-ftgroup.com).

I. Greiss is with Rosetta IP Ltd, Netanya 42505, Israel (e-mail: israelg@rosetta-ip.com).

R. Gaudino is with Istituto Superiore “Mario Boella” and Politecnico di Torino, Dipartimento di Elettronica, 10129 Torino, Italy (e-mail: gaudino@polito.it).

Color versions of one or more of the figures in this paper are available online at <http://ieeexplore.ieee.org>.

Digital Object Identifier 10.1109/JLT.2010.2096199

This ambitious goal requires careful optimization of the three main degrees of freedom available to the designer of POF-based systems, which are as follows.

- 1) Optimization of the optoelectronics on the transmitter and receiver side, for maximal bandwidth, sensitivity and linearity.
- 2) Selection of the most suitable modulation formats at the transmitter.
- 3) Selection of the POF type among the different solutions available on the market. While the standard step-index POF does not seem suitable for multi-gigabit transmission (over lengths suitable for in-building deployments), the other options available are graded-index (GI) POF and step-index multi-core plastic optical fiber (MCPOF), both with a large core diameter.

Hence, the main goal of this paper is to review the options and best solutions available for each of these three points, as currently under investigation in the EU FP7 project POF-PLUS for multi-gigabit transmission. This paper is therefore organized as follows: in Section II, the choice of the plastic optical fiber technology is outlined with the differences in performance addressed. Then the main characteristics of multi-gigabit optoelectronic transmitter and the performance analysis of the modulation formats (DMT and PAM) are given in Section III. The experimental validation of the various systems follows in Section IV. Discussion on the various systems and concluding comments are given in Section V.

II. PLASTIC OPTICAL FIBER TECHNOLOGIES

A. Single-Core Step-Index Plastic Optical Fibers

Using standard step-index plastic optical fibers, transmission systems which operate at 100 Mbit/s are today commercially available over lengths up to 70–80 meters, while the possibility to reach much more than 100 m has been demonstrated [10]. Due to its large numerical aperture (NA) of 0.5, the bandwidth \times distance product of SI-POF is around 50 MHz \times 100 m. Hence, its ability to carry data at multi-gigabit rates for next generation systems over similar distances is limited. Nevertheless, several advanced modulation techniques have been proposed recently with up to 1.62 Gbit/s over 100 m SI-POF transmission as demonstrated in [6]. To improve the low-pass channel bandwidth and the bending properties of standard SI-POFs, the step-index multi-core POF was recently introduced [11].

B. Multi-Core Step-Index Plastic Optical Fibers

One of the main advantages of SI-MCPOF is the lower bending loss when compared to single core POFs. The smaller diameter of the individual cores in multi-core SI-POF shown in Fig. 1 supports less mode groups and hence less sensitive to macro bending loss. By comparison, single-core POFs are more susceptible to bending losses as a larger number of mode groups are present.

Particularly, high-order mode groups are sensitive to bending losses. In this paper, we employ 1 mm core diameter SI-MCPOFs (Asahi SMCK-1000P [11]) with NA of 0.5, each core has an approximate diameter of 200 μ m with fluorinated

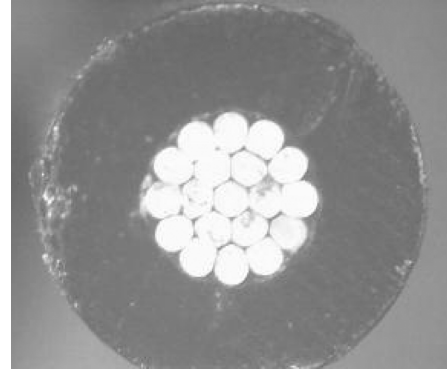

Fig. 1. Illuminated 19-core SI-MCPOF.

cladding polymer of 4–8 μ m thick. The bending radius is 2 mm and the attenuation is 0.2 dB/m at 667 nm.

C. Single-Core Graded-Index Plastic Optical Fibers

In contrast with single-core SI-POF, single-core graded-index POF is attractive due to its larger bandwidth compared with SI-POF as shown in Fig. 12. More than 4 Gbit/s transmission rate has been reported using 50 m GI-POF [12]. Although, multi-gigabit transmission rates can be achieved with GI-POF, graded-index profile requires a more complex manufacturing process. The attenuation of 0.3 dB/m is slightly higher than for single and multi-core SI-POFs.

In this paper, we will present results obtained with both SI-MCPOF and GI-POF, the two solutions that seem more suitable for multi-gigabit transmission targets. Ultimately, the choice of plastic optical fiber technology is a tradeoff between the tolerance to bending and available channel bandwidth in order to maximize bandwidth \times distance product for multi-gigabit applications.

III. COMPARISONS BETWEEN MODULATION FORMATS

Before comparisons between modulation formats can be carried out, the characterization of a specific VCSEL suitable for POF (Firecomms RVM665T [13]) is performed since it is employed in most of the setups described in the following sections. The bandwidth and signal to noise ratio (SNR) will be discussed in the experimental setups.

Next in this section, we compare the use of different modulation formats over the same optoelectronic setup. While a detailed theoretical analysis of this problem was recently published in [14], we believe this is the first paper to report a completely experimental assessment. To this end, a typical off-line processing approach was employed in different experiments, all following the schematic presented in Fig. 2.

A. Influence of Transceiver Linearity

A key performance indicator of the linearity of a directly-modulated VCSEL transmitter is the spurious-free dynamic range (SFDR). This is defined as the ratio of the signal output to the second and third-order inter-modulation products.

As the modulation depth is increased, the harmonic strength of second and third-order inter-modulation products which occur within the signal bandwidth increase [15].

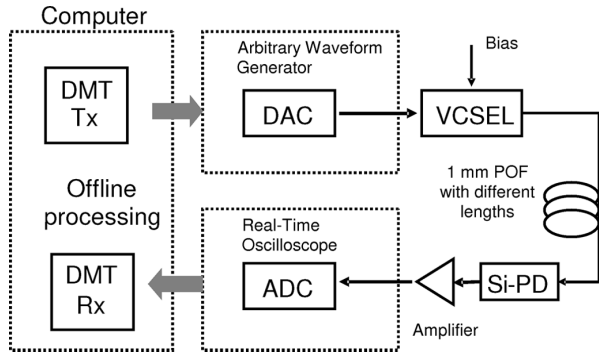

Fig. 2. Experimental setup.

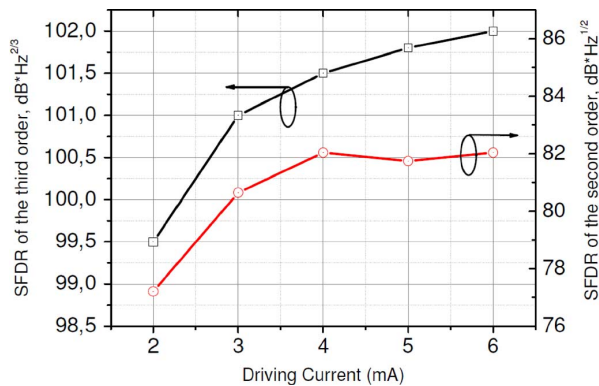

Fig. 3. Linearity performance of the VCSEL.

The linearity of the VCSEL was measured by employing the two-tone modulation test (using 365 and 375 MHz) in the back-to-back case and using a Silicon photodetector with bandwidth of 1.4 GHz. By injecting these tones, second and third order harmonics are generated and used to obtain the second/third-order intercept points as the bias current of the VCSEL is varied. The resulting SFDR can be calculated using these values [16]. As shown in Fig. 3, the SFDR of the second and third order indicates that the difference between the signal and the level of the inter-modulation products is maximized at bias current > 4 mA, beyond which this difference saturates. Hence, from a linearity point of view it is recommended to operate the VCSEL above 4 mA. In the following subsections, the optimal bias current is further analyzed for the various modulation formats employed.

B. Common Test Setup

Fig. 2 represents the common test setup with which the three modulations were tested. The optical POF link uses the red VCSEL described in the previous Subsection with a modulation bandwidth of the order of 3 GHz. The transmitter is followed by 50 m of 1 mm SI-MCPOF (19 cores). Finally, a photo-receiver based on a Silicon PIN diode photodiode placed closely to an integrated trans-impedance amplifier (TIA) is used. The receiver bandwidth is in excess of 1 GHz. The PAM and DMT transmitted samples were coded on a computer using Matlab[®] then uploaded to an arbitrary waveform generator (AWG) where the

test signals are generated with a sampling rate chosen in accordance with the specific modulation type (in this case, the maximum is 4.2 GS/s). The OOK modulation was generated using a standard pseudo-random binary sequence (PRBS) generator. The electrical signal after the photo-receiver was captured using a real time oscilloscope operating at 10 GS/s at 8 bit resolution and the captured data was loaded onto a computer for demodulation and performance evaluation. The target data rate was set to 2.5 Gbit/s and the performance was measured by evaluating the BER of the received signal. For each modulation type, the VCSEL bias point was chosen to optimize the power output whilst minimizing the BER.

As 1 mm core diameter POF is an inherently bandwidth limited media for transmission of multi-gigabit (> 1 Gbit/s) signals, it is thus relevant to test the performance of several modulation formats (single and multi-carriers) to determine the optimum choice and obtain the best compromise between performance and implementation cost. Three approaches are identified as potential candidates: Discrete multi-tone modulation known for its ability to obtain very high spectral efficiency and ability to solve severe channel response cases, but requires high peak-to-average power, 4 level Pulse Amplitude Modulation (4-PAM) and, finally, 2 level PAM (2-PAM) or On-Off Keying (OOK) both in combination with receiver electrical adaptive equalization to mitigate the bandwidth limitation problem while tolerating high levels of non-linearity.

C. On-Off Keying Modulation (OOK)/2-Level Pulse Amplitude Modulation

A 2.5 Gbit/s OOK PRBS sequence was generated with $2^7 - 1$ length and used for VCSEL modulation. After 50 m transmission over 1 mm core diameter SI-MCPOF and photo-detection, the electrical signal was captured and demodulated by offline processing on the computer. The digital receiver process includes: re-sampling to the optimal frequency and phase at the symbol rate timing, an adaptive decision feedback equalizer (DFE) based on minimum mean square error (MMSE) adaptation over 10 coefficients of T-spaced FFE and 10 coefficients of DFE. The equalized samples on the slicer input and a soft error quality indicator is employed in the measurement of the hard error-rate and to estimate the probability of errors when no hard errors occur. The bit error rate was calculated and reported for each targeted value of VCSEL bias current and peak-to-peak modulation amplitude. Fig. 4 shows the results represented as a contour plot of the achieved BER measurements. The numbers on each contour denote the exponent x of the BER (10^x). The plot indicates that the optimal BER of 10^{-7} is obtained at a VCSEL bias current of 6.5 mA and modulation amplitude of 1.25 V.

D. 4 Level Pulse Amplitude Modulation

A PRBS coded 4-PAM sequence generated on the computer with 8 bit DC balancing and uploaded to an AWG with 2 bits per symbol (Sampling rate of 2.5 GS/s). This signal was used for VCSEL modulation. Similarly to what is reported in the OOK/2-PAM case, after 50 m transmission over 1 mm core diameter SI-MCPOF, the output signal is captured and processed with a MMSE DFE receiver that uses a 4 level slicer. Fig. 5

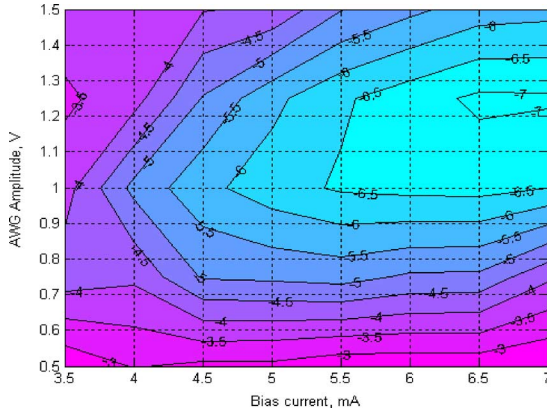

Fig. 4. BER for OOK/2PAM modulation after 50 m SI-MCPOF transmission at 2.5 Gbit/s data rate for different values of VCSEL bias and modulation amplitude.

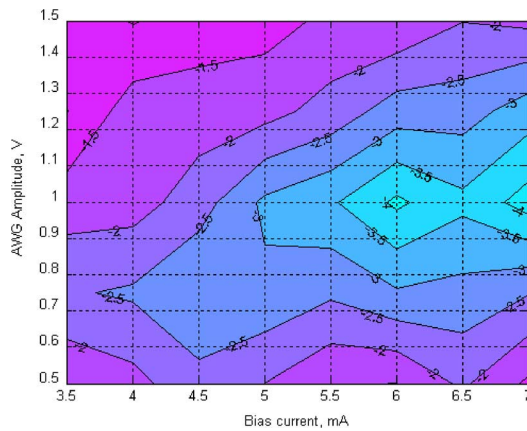

Fig. 5. BER for 4-PAM modulation after 50 m SI-MCPOF transmission at 2.5 Gbit/s data rate for different values of VCSEL bias and modulation amplitude.

shows the BER calculated from the received signals. Notice that a minimum BER of 10^{-4} is achieved for 7 mA VCSEL bias current using the modulation amplitude of 1.0 V.

In addition, simple non-linear receiver equalizers were tested to solve the non-linearity distortions which are noticeable with 4-PAM, however the performance gain was not significant. The type of noise produced by the tested optical channel non-linearity cannot be solved exclusively at the receiver, hence compensation at the transmitter may be necessary to improve performance.

E. Discrete Multi-Tone Modulation (DMT)

Derived from the more general orthogonal frequency division multiplexing [14], DMT is a baseband version multicarrier modulation technique where a high-speed serial data stream is divided into multiple lower-speed streams in parallel and modulated onto subcarriers of different frequencies for transmission. This technique is widely applied in large scale to digital subscriber copper lines (xDSL) and power-line communication systems [17], [18]. An important advantage of DMT is the possibility to allocate an arbitrary number of bits per subcarrier according to the corresponding signal-to-noise ratio (SNR) profile of the channel. This is typically known as bit-loading. In this present study, Levin-Campello technique is employed for the margin-adaptive bit-loading algorithm applying the DMT

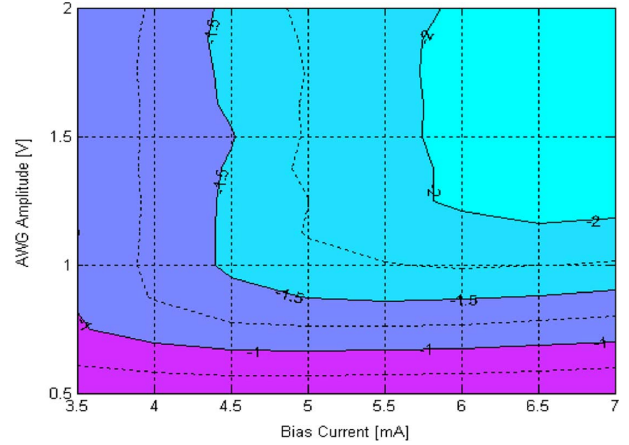

Fig. 6. BER for DMT modulation after 50 m SI-MCPOF transmission at 2.5 Gbit/s data rate for different values of VCSEL bias and modulation amplitude.

technique with up to 32-level quadrature amplitude modulation (32-QAM) [19]. In this section, the first step is the channel estimation which uses a probing signal consisting of 162 subcarriers modulated by 4-QAM over the bandwidth of 650 MHz with a 4 GS/s sampling rate. 8 samples of cyclic prefix are appended to the signal.

The DMT signal at 2.5 Gbit/s is then transmitted over the optical system and its performance is evaluated. In the second step, this signal is generated and its bit error rate is measured. This two step process is repeated for all targeted values of VCSEL modulation power and bias measurements reported in Fig. 6. As indicated by the contour plot figure, the measured minimum BER of 10^{-3} is achieved for a bias > 7 mA and a peak-to-peak modulation of 1.5 V is obtained.

F. Discussion

Although DMT is in several scenarios (xDSL, wireless, etc.) best suited for compensating severe channel response, the best performance at 2.5 Gbit/s over the setup described so far is achieved in the previously described POF system with the simple OOK modulation combined with receiver side equalization (FFE/DFE). Detrimental to DMT and high-level PAM (4-PAM or higher) modulation is the non-linearity of the VCSEL transmitter and, likely, some residual nonlinearity in the receiver. The frequency response of the POF link is quite smooth, does not include severe notches (see Fig. 12) and therefore can be equalized using a single carrier DFE. Thus, in terms of implementation cost, the use of the OOK modulation scheme combined with already existing recursive filter chips at 2.5 Gbit/s seems to be a good candidate for higher data rates at low cost. This conclusion is in-line with the theoretical results presented in [14].

Notice that in the comparison between the modulation formats, we employed relatively modest bit rates and use the multi-core step-index plastic optical fiber. In order to achieve > 2.5 Gbit/s, more complex modulation formats are required as higher spectral efficiency can be achieved.

Hence in the following sections, we discuss transmission systems for achieving up to 10 Gbit/s transmission focusing on

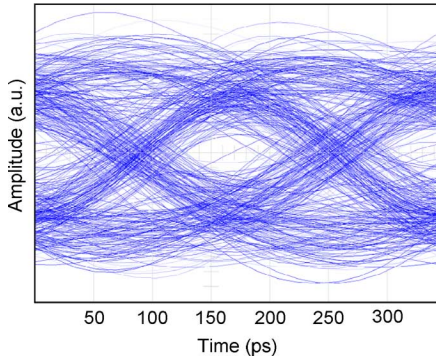

Fig. 7. Evaluated eye diagram after 50 m GI-POF.

multi-core step-index and single-core graded-index 1 mm core diameter POFs.

IV. MULTI-GIGABIT TRANSMISSION RECORDS

Using different transceiver setups, the achieved transmission records employing in particular single-core GI-POF and SI-MCPOFs were evaluated. The aim was to maximize the transmission rate over POF lengths that are suitable for in-home applications (up to 50 m). The results of the respective experiments carried out are reported in the following subsections.

A. 5.8 Gbit/s Transmission Over 50 Meters Single-Core GI-POF Employing 2-PAM and DFE

The experimental setup consists of 650 nm edge emitting laser with an optical power of +6 dBm. (Union Optronics SLD-650-P10-RG-03). The laser diode was directly modulated with a pseudo-random bit sequence length of $2^7 - 1$. In this work, 2-PAM/OOK modulation is generated employing Agilent N4872 BER measurement system. After 50 m transmission, the POF-optimized receiver comprises of a silicon pin photodiode with an active diameter of 400 μm (responsivity of 0.5 A/W) is used with commercially available trans-impedance amplifier (Mindspeed M02013) with trans-impedance gain of 10 k Ω . To achieve a higher coupling efficiency, a dielectric taper is used to guide the light to the diode's active area.

The measurement after 50 m single-core GI-POF achieved 5.8 Gbit/s at a BER of 10^{-3} . The back-to-back measurements achieved only 6.5 Gbit/s which is due to the bandwidth limitation of the transceiver setup. After transmission over 50 m GI-POF, the received signal is recorded by the real-time oscilloscope and equalized in post-processing with a DFE adaptive algorithm implemented in Matlab[®]. The DFE scheme used 25 forward and feedback taps. Fig. 7 shows the evaluated eye diagram at BER of 10^{-3} corresponding to the transmission rate of 5.8 Gbit/s.

Note that one of the advantages of 2-PAM/OOK over DMT techniques is the simplicity and the negligible effect of non-linearity on transmission.

B. 5.3 Gbit/s Transmission Over 50 Meters Single-Core GI-POF

Employing the same experimental setup shown in Fig. 2, low-cost VCSEL at 667 nm with a bandwidth of 3 GHz was directly

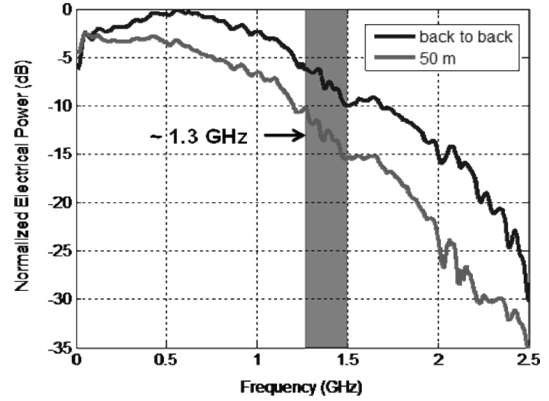

Fig. 8. Normalized frequency response of back-to-back and 50 m GI-POF configurations.

modulated by the output of the AWG running at a sampling rate of 4.5 GHz. The bias current of the VCSEL was set to 4 mA, hence a peak-to-peak driving current of maximum 7 mA. Corresponding to the levels set for eye safety regulations, an optical power of 0 dBm was launched into the POF link. After signal transmission over 50 meters link, the optical power received was -15 dBm mainly attributed to attenuation in the POF (0.3 dB/m at 667 nm). A low-cost Silicon photodetector with a photosensitivity area of diameter 400 μm and a responsivity of 0.5 A/W at red light region is used to receive the signals. In addition, it is equipped with a trans-impedance amplifier with a trans-impedance gain of 10 k Ω . The receiver is optimized for DMT with a bandwidth of more than 1.6 GHz.

The received signal is evaluated using a real-time oscilloscope running at a sampling rate of 50 GSamples/s for off-line processing in Matlab[®]. The high sampling rate is due to lack of synchronization between the AWG and real-time scope; hence phase information has to be extracted from the DMT frame. The maximum available bandwidth after 50 m is approximately 1.3 GHz as shown in Fig. 8. By using the adaptive bit-loading algorithm, the limited bandwidth can be used efficiently, hence increasing the spectral efficiency. As shown in setup diagram in Fig. 2, the DMT (de-)modulation is executed offline to calculate the optimal bit-loading parameters. In this experiment, we chose 256 subcarriers, ranging from 0 to 2.25 GHz. Employing higher number of subcarriers did not improve the transmission rates considerably. The algorithm measured the SNR per subcarrier which is shown as a function of frequencies in Fig. 9. Accordingly, the algorithm allocated bits per subcarrier to obtain an optimum transmission rate. Notice that the received SNR values present a stair-like curve shown in Fig. 9 (lower). Also, shown is a truncation at the frequency of 1.42 GHz above which no bits are assigned.

In Fig. 9 (upper), 5 bits are allocated mainly between the 21st and 45th subcarrier group reducing to 0 bits being assigned beyond the 162nd subcarrier or 1.42 GHz. This truncation is largely caused by the system bandwidth shown in Fig. 8. Moreover, the robustness of the system is further demonstrated in Fig. 9 where the power loading algorithm efficiently allocates bits to the carriers corresponding to the available SNR determined by the response of the system. By using a low number of subcarriers

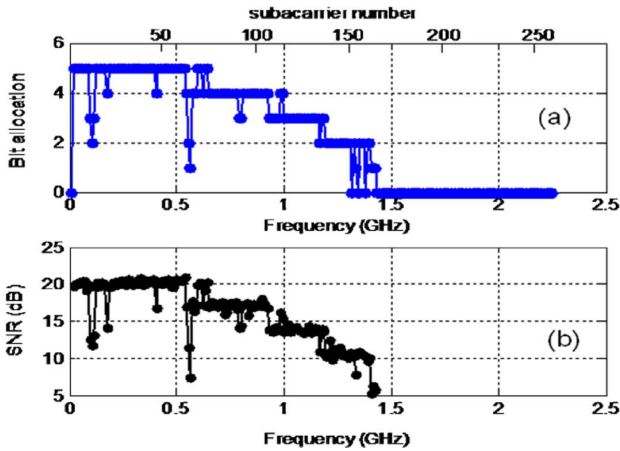

Fig. 9. Transmission performance for 50 m: (upper) bit allocation and (lower) SNR.

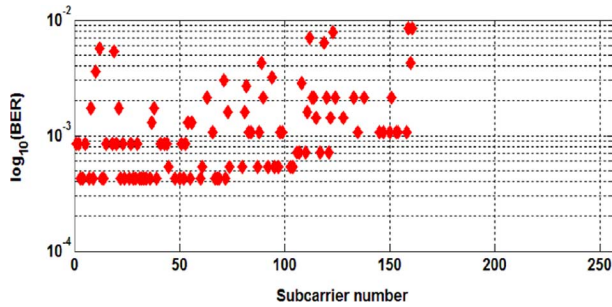

Fig. 10. BER for different subcarriers at 5.3 Gbit/s over 50 m.

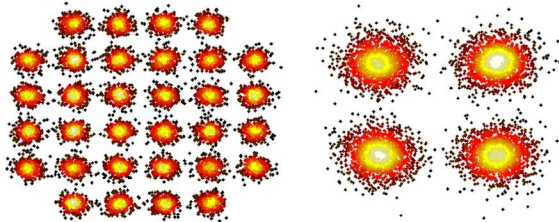

Fig. 11. Constellation of received signal at 5.3 Gbit/s over 50 m: (a) 32 QAM for highest subcarrier indices, (b) 4 QAM for lowest subcarrier indices.

and low bits per subcarrier, less processing is required, making the implementation of a low-cost device possible.

In Fig. 10, the measured values of BER after 50 m POF transmission for all the subcarriers are shown. Notice that most subcarriers meet the target BER of 10^{-3} , which is chosen based on the forward error correction (FEC) limit for error-free operation. Reducing the POF length results in the following transmission rates; for BER below 10^{-3} , transmission rates of approximately 6.2, 7.2 and 7.6 Gbit/s are achieved over 35, 20 and 10 m respectively.

Note that for the target POF length of 50 m, we are still able to achieve 5.3 Gbit/s which is a record transmission rate. All bit rates mentioned in this paper includes the 7% FEC bits, cyclic prefix and preambles. The received signal is demodulated and Fig. 11 indicates clear constellation plots for 32 QAM in higher subcarrier indexes before 0.5 GHz and 4 QAM for the lower subcarrier indexes after 1.2 GHz.

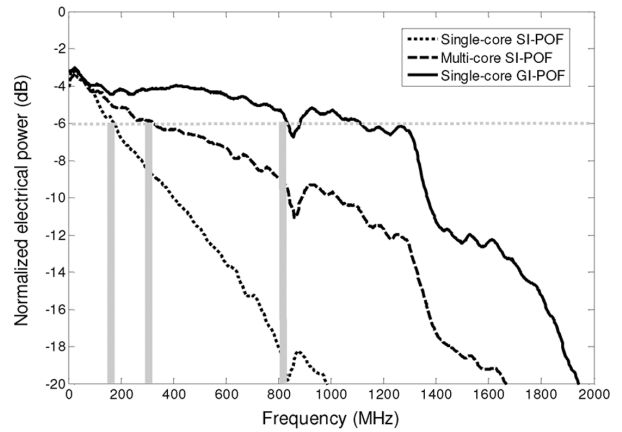

Fig. 12. Normalized frequency response after 50 m of SI-POF, GI-POF and SI-MCPOF [20].

C. 4.7 Gbits/s Transmission Over 50 Meters of Step-Index Multi-Core POF

The same setup as above is used in this experiment. The setting of the generator, the scope and VCSEL transmitter is kept the same. Here, after the 50 m SI-MCPOF link a low-cost \emptyset 230 μ m photosensitive area avalanche photodetector (APD) with a 3 dB bandwidth of approximately 1.3 GHz was used to detect the signal. This APD detector has a flatter response than the detector employed in Sub-Section B.

The measured bandwidth after 50 m of the SI-MCPOF system is shown in Fig. 12. For comparison, two other curves corresponding to conventional single-core SI-POF and single-core GI-POF are also presented. Note that 19-core SI-MCPOF exhibits higher bandwidth than standard SI-POF with a maximum available bandwidth at 3 dB from DC to 350 MHz. In Fig. 12, the three vertical gray lines indicate the bandwidth at 3 dB from DC for the three different fibers. We observed that the bandwidth of SI-MCPOF is much larger than conventional single-core SI-POF, but narrower than the bandwidth of single-core GI-POF.

By using the adaptive bit-loading algorithm, the limited bandwidth for SI-MCPOF is used effectively to maintain spectral efficiency. Note that as the number of sub-carriers is increased, the response of the channel can be finely divided into more sub-channels. The result is that the sub-carriers experience better channel response improving performance. In this experiment, the use of 512 subcarriers between 0 to 3 GHz was the optimal choice for best performance. The algorithm measured SNR per subcarrier. As shown in Fig. 13 (lower), the measured SNR is a continuous curve as a function of frequencies. Based on this response, the algorithm allocated the appropriate number of bits per subcarrier to obtain an optimum transmission rate. Largely caused by the limited system bandwidth, the received SNR values shown in Fig. 13 present a stair-like curve truncated at 1.6 GHz, corresponding to the 275th subcarrier.

Moreover, we can see in Fig. 13 (upper), that some of the carriers are allocated with the upper limit of 4 bits of information (i.e., 16-QAM), while others are allocated less bits. The number of bits allocated matches the response of the system indicated in Fig. 12 for SI-MCPOF. After 50 m, as Chow’s rate-adaptive bit-loading algorithm is employed, the 3 dB bandwidth of POF

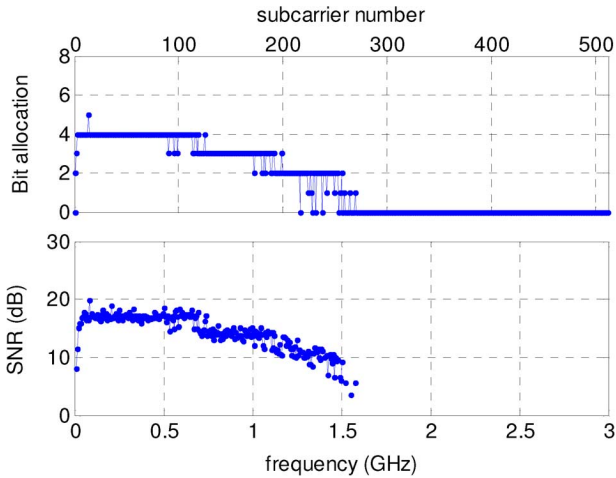

Fig. 13. Transmission performance after 4.7 Gbit/s transmission over 50 m SI-MCPOF link: (upper) bit allocation and (lower) SNR.

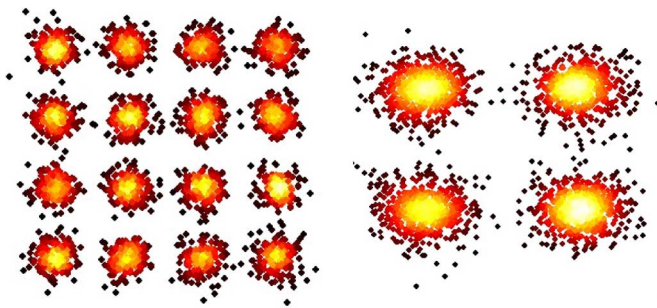

Fig. 14. Constellation of received signal: (a) 16 QAM for highest subcarrier indices, (b) 4 QAM for lowest subcarrier indices.

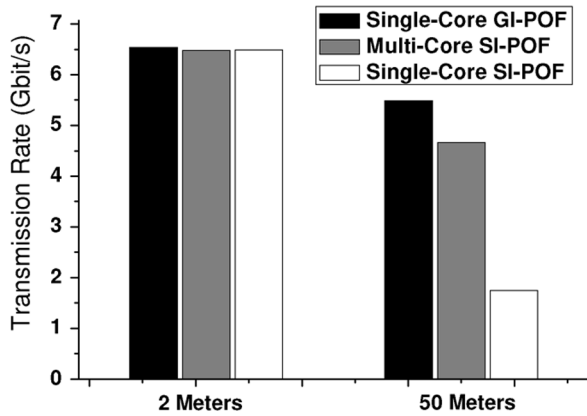

Fig. 15. Maximum transmission rate for 2 and 50 m single-core SI-, MC SI- and single-core GI-POF.

systems shown in Fig. 12, are exploited as effectively as possible to deliver the best transmission results.

Finally, the demodulated signal constellation diagrams are shown for two sub-carrier index groups in Fig. 14. As shown in Fig. 13 (upper), 4 bits are mainly allocated for the 4th to 50th sub-carrier, corresponding to the 16-QAM constellation. While in only 2 bit (4-QAM) allocations are mainly between the 201th to 210th sub-carrier.

Fig. 15 shows the measured values of maximum bit rate which can be transmitted over 50 m conventional single-core SI-POF,

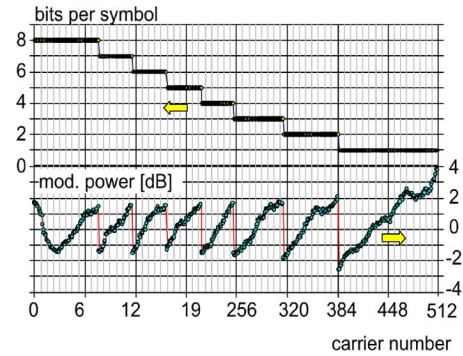

Fig. 16. Bit (upper) and power loading (lower).

19-core MC SI-POF and conventional GI-POF, for a BER of less than 10^{-3} . This target BER is chosen based on the FEC limit of error-free operation. For 2 m back-to-back measurement, the performances of SI, MC- and GI-POF are very similar; this can be attributed to the bandwidth of the system being limited by the transceiver, instead of the POF link. The second data cluster points to the clear advantage of MC SI-POF over conventional SI-POF in terms of transmission rate. For single-core SI-POF, less than 2 Gbit/s transmission rate was achieved. However, by using MC SI-POF, we realize more than twice the transmission rate compared to single-core SI-POF. Moreover, it is worth noting that the maximum transmission rate of MC SI-POF is only 0.7 Gbit/s less when compared to GI-POF. Considering the overall performance and cost issues, MC SI-POF can be presented as a competent candidate for application in short range access networks.

D. 10 Gbit/s Transmission Over 25 Meters Step-Index Multi-Core POF

According to Fig. 15, it is impossible to achieve more than 2 Gbit/s for 50 m single-core SI-POF using eye-safe VCSEL transmitters. In order to achieve higher transmission rates, high-power lasers and different SI-POF structure is required. Here, we demonstrate that using high-power directly modulated lasers and SI-MCPOF, the transmission rate can be increased significantly.

The optical transmitter is a commercially available red laser diode with a wavelength of 650 nm and an optical output power of +7 dBm, hence better SNR can be achieved when compared to eye-safe transmitters. The laser diode is operated in its linear region with a modulation index of approximately 0.9. The photodetector used in Section IV.A is employed in this work.

For the DMT signal, 512 subcarriers distributed over a bandwidth of 2.5 GHz. The frequency response of the system after 25 m SI-MCPOF link was measured and each subcarrier's power and modulation format (from 2- to 256-QAM) is chosen accordingly. The DMT clipping level was optimized at 9.5 dB

As displayed in Fig. 16 (lower), the power loading presents the recognizable saw-tooth shape with approximately 3 dB peak-to-peak deviation, which allows the support of approximately the same BER in each subcarrier.

The bit loading per subcarrier is as shown in Fig. 16 (upper).

As in the above subsection, the launching condition is such that all 19 cores are illuminated by the VCSEL power similar to

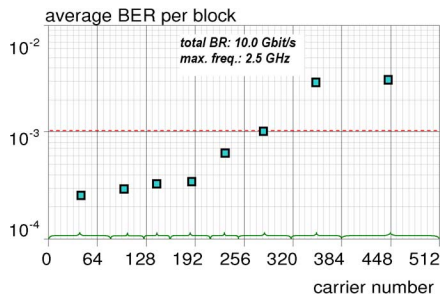

Fig. 17. Measured BER averaged over the all subcarriers in the group.

single-core POF case. The low bending loss, large core area and ease of installation makes the SI-MCPOF the preferred choice for multi-gigabit applications. Fig. 17 shows the measured BER, averaged over the subcarriers with the same modulation level. The green line indicates the subcarriers indexes over which the BER is calculated. The higher subcarrier indexes (subcarrier frequencies) perform worse due to channel response.

Note that despite the BER of the higher subcarriers (320th and higher) being above 1×10^{-3} , the FEC limit for error free transmission indicated by the red line, the total average BER of the system was 9.5×10^{-4} corresponding to the achieved transmission rate of 10 Gbit/s.

Although the Emitted Power of +7 dBm is not eye safe, a higher power is necessary to achieve the power margins required to achieve high bit rate transmission.

V. COMMENTS AND CONCLUSIONS

We have shown several experimental demonstrations of multi-gigabit transmission over single and multi-core 1 mm POFs. The achieved results demonstrate significant progress in short-range in-home communications made possible by a combination of advanced optoelectronics and high-speed modulation formats. These techniques require careful link optimization options including; pre/post digital signal processing, the choice of optical transmitter, modulation technique, fiber technology and optical receiver in order to achieve these state-of-the-art results. We have shown the possibility to achieve high bit-rates employing low-cost and eye-safe transceivers which conform to standard recommendations. However, to scale towards 10 Gbit/s transmissions, adequate power margins are required using higher power lasers.

The demonstrations presented in this paper are proof-of-concept laboratory experiments using, in most cases, off-line digital signal processing techniques and off-the-shelf components. Future work will focus on the implementation of such systems in a realistic environment taking into account real-time signal processing, building restrictions (bending tolerance), user eye-safety regulations and convergence with existing in-home applications.

We believe that the POF-PLUS project has shown key areas which require further development before a fully-engineered multi-gigabit transmission system for large core POF is made commercially available for wide-scale deployment.

ACKNOWLEDGMENT

The authors acknowledge the invaluable contribution of the consortium partners. Firecomms Ltd. is gratefully acknowledged for the RVM665T VCSEL employed in this work.

REFERENCES

- [1] S. Randel, S. C. J. Lee, B. Spinnler, F. Breyer, H. Rohde, J. Walewski, A. M. J. Koonen, and A. Kirstädter, "1 Gbit/s transmission with 6.3 bit/s/Hz spectral efficiency in a 100 m standard 1 mm step-index plastic optical fiber link using adaptive multiple sub-carrier modulation," in *Proc. ECOC*, 2006, Postdeadline Paper Th4.4.1.
- [2] F. Breyer, S. C. J. Lee, S. Randel, and N. Hanik, "1.25 Gbit/s transmission over up to 100 m standard 1 mm step-index polymer optical fiber using FFE or DFE equalization schemes," in *Proc. ECOC*, 2007, Paper 9.6.6.
- [3] H. Yang, S. C. J. Lee, E. Tangdiongga, C. Okonkwo, H. van den Boom, F. Breyer, S. Randel, and A. M. J. Koonen, "47.4 Gb/s transmission over 100 m graded-index plastic optical fiber based on rate-adaptive discrete multitone modulation," *J. Lightw. Technol.*, vol. 28, no. 4, pp. 352–359, Feb. 15, 2010.
- [4] H. Yang, S. C. J. Lee, C. M. Okonkwo, S. T. Abraha, H. P. A. van den Boom, F. Breyer, S. Randel, A. M. J. Koonen, and E. Tangdiongga, "Record high-speed short-range transmission over 1 mm core diameter POF employing DMT modulation," *Opt. Lett.*, vol. 35, no. 5, pp. 730–732, Mar. 1, 2010.
- [5] S. Loquai, R. Kruglov, O. Ziemann, J. Vinogradov, and C. Bunge, "10 Gbit/s over 25 m plastic optical fiber as a way for extremely low-cost optical interconnection," in *Proc. OFC/NFOEC*, 2010, Paper OWA6.
- [6] S. C. J. Lee *et al.*, "High-speed transmission over multimode fiber using discrete multitone modulation," *J. Opt. Netw.*, vol. 7, no. 2, pp. 183–196, Feb. 2008.
- [7] S. C. J. Lee, F. Breyer, S. Randel, R. Gaudino, G. Bosco, A. Bluschke, M. Matthews, P. Rietzsch, R. Steglich, H. P. A. van den Boom, and A. M. J. Koonen, "Discrete multitone modulation for maximizing transmission rate in step-index plastic optical fibers," *J. Lightw. Technol.*, vol. 27, no. 11, pp. 1503–1513, Jun. 1, 2009.
- [8] F. Breyer, S. C. J. Lee, S. Randel, and N. Hanik, "Comparison of OOK- and PAM-4 modulation for 10 Gbit/s transmission over up to 300 m polymer optical fiber," in *Proc. OFC/NFOEC*, 2008, Paper OWB5.
- [9] F. Breyer, S. C. J. Lee, S. Randel, and N. Hanik, "PAM-4 signalling for gigabit transmission over standard step-index plastic optical fiber using light emitting diodes," in *Proc ECOC*, 2008, Paper We.2.A.3.
- [10] D. Cardenas, A. Nespola, S. Camatel, S. Abrate, and R. Gaudino, "100 Mb/s ethernet transmission over 275 m of large core step index polymer optical fiber: Results from the POF-ALL european project," *J. Lightw. Technol.*, vol. 27, no. 14, pp. 2908–2915, Jul. 15, 2009.
- [11] [Online]. Available: <http://www.asahi-kasei.co.jp/ake-mate/pof/en/product/multi-core.html>
- [12] H. Yang, E. Tangdiongga, S. C. J. Lee, S. Randel, H. P. A. van den Boom, and A. M. J. Koonen, "4 Gbit/s over 50-m large core diameter GI-POF using low-cost VCSEL," in *Proc. ECOC*, 2009, Paper 3.5.1.
- [13] [Online]. Available: <http://www.firecomms.com/products-laser.html>
- [14] S. Randel, F. Breyer, J. Lee, and J. Walewski, "Advanced modulation schemes for short-range optical communications," *IEEE Sel. Topics Quantum Electronics*, vol. 16, no. 5, pp. 1280–1289, Sep.–Oct. 2010.
- [15] W. E. Stephens and T. R. Joseph, "System characteristics of direct modulated and externally modulated RF fiber-optic links," *J. Lightw. Technol.*, vol. LT-5, no. 3, pp. 380–387, 1987.
- [16] D. M. Pozar, *Microwave Engineering*, 3rd ed. New York: Wiley, 2005.
- [17] Guerrieri, P. Bisaglia, G. Dell'Amico, and E. Guerrini, "Performance of the turbo coded HomePlug AV system over power-line channels," *Proc. IEEE ISPLC*, pp. 138–143, Mar. 2007.
- [18] T. Starr, J. M. Cioffi, and P. Silvermann, *Understanding Digital Subscriber Line Technology*. Englewood Cliffs, NJ: Prentice Hall, 1999, ISBN-13-780545-4.
- [19] J. Campello, "Optimal discrete bit-loading for multicarrier modulation systems," in *Proc. IEEE Int. Symp. Inf. Theory*, 1998, p. 193.
- [20] H. Yang *et al.*, "4.7 Gbit/s transmission over 50 m long 1 mm diameter multi-core plastic optical fiber," in *Proc. OFC/NFOEC*, 2010, Paper OWA4.

Author biographies not included at authors' request due to space constraints.