

Estimation of the Permittivity of Dielectrics from the Scattering Responses of TEM Waveguides

Original

Estimation of the Permittivity of Dielectrics from the Scattering Responses of TEM Waveguides / Maio, Ivano Adolfo; Savi, Patrizia; Marino, Francesco. - ELETTRONICO. - (2009), pp. 240-245. (Mediterranean Microwave Symposium Tangiers, Morocco November, 15-17) [10.1109/MMS.2009.5409775].

Availability:

This version is available at: 11583/2303576 since:

Publisher:

Published

DOI:10.1109/MMS.2009.5409775

Terms of use:

This article is made available under terms and conditions as specified in the corresponding bibliographic description in the repository

Publisher copyright

(Article begins on next page)

Estimation of the Permittivity of Dielectrics from the Scattering Responses of TEM Waveguides

Ivan A. Maio and Patrizia Savi
Dip. Elettronica
Politecnico di Torino
C. Duca degli Abruzzi 24
10129 Torino, Italy
Email: patrizia.savi@polito.it

Francesco Marino
Dip. Scienza Materiali
Politecnico di Torino
C. Duca degli Abruzzi 24
10129 Torino, Italy
Email: francesco.marino@polito.it

Abstract—This paper addresses the de-embedding of the propagation function of waveguides from the scattering responses of setups composed of TEM waveguides terminated by launchers that introduce generic discontinuities. The de-embedding is aimed at estimating the permittivity of dielectric samples from the scattering responses of waveguides including the samples. The de-embedding is based on the double-delay method [2], that is applied to setups involving different launchers. A modified version of the method is also proposed to facilitate the measurement process.

I. INTRODUCTION

An important method to estimate the permittivity of dielectric materials amounts to measuring the scattering responses of a TEM waveguide filled by the dielectric to be characterized and to inverting the scattering responses for the unknown permittivity. In a uniform TEM waveguide the relation between the permittivity of the filling dielectric and the propagation function is simple, and the resulting inversion problem is readily solved. This approach is exploited in many applications where the estimation of the permittivity over wide frequency bands is required, as in the characterization of dielectric materials for electronics packaging and in the measurement of the permittivity of soils in soil science.

In order to connect a uniform TEM waveguide to a Vector Network Analyzer (VNA), however, the waveguide must be completed by suitable launchers at its ends. Depending on the specific application, the launchers can be a significant discontinuity, and can lead to a transmission response of the composite system waveguide plus launchers that is different from the propagation function of the waveguide alone. The problem then becomes how to eliminate the effects of launchers from the scattering responses of the waveguide and its launchers, obtaining the transmission response of the waveguide.

The most common method to estimate the propagation function of a waveguide from the scattering responses of a sample of the waveguide is the Nicolson-Ross method [1]. This method yields the expression of the waveguide propagation factor as a function of the measured reflection and transmission scattering responses. Unfortunately, this method describes the launchers as ideal impedance discontinuities occurring between the characteristic impedance of the cables

of the VNA and the characteristic impedance of the waveguide under test. In many practical cases this assumption does not hold, because a field matching process takes place at the junction between the launchers and the waveguide. Setups composed of planar waveguides (*i.e.*, microstrips or striplines structures) connected to the VNA via coaxial connectors, and large diameter coaxial probes like those used for soil measurements are examples involving reactive contributions from the launchers.

The problem at hand is a particular case of the general de-embedding problem occurring in microwave, when the effects of the launchers used to connect an n -port element to a VNA must be eliminated from the measured scattering responses. For this problem, several de-embedding methods have been developed, *e.g.*, see [2] and [3]. A comparison of some de-embedding methods is in [4]. The double-delay method of [2], in particular, seems well suited to the de-embedding of the propagation function of a waveguide terminated by arbitrary launchers.

In this paper, we experiment with the double-delay method, with the aim of estimating dielectric permittivities from the measured scattering responses of waveguides. The method is applied to different setups involving arbitrary launchers and its ability to de-embed the effect of the launchers and to lead to correct estimates of the dielectric permittivity is verified.

II. DE-EMBEDDING OF WAVEGUIDE RESPONSES

The double-delay method of [2] that we use in this study is based on the scattering responses of a pair of test structures composed of a segment of the waveguide being characterized and its launchers. The two test structures must differ for the length of the waveguide segment only. Furthermore, the shortest waveguide segment must be long enough to guarantee that a pure TEM propagation takes place for a part of the segment. In contrast, the left and right launcher can be different, *i.e.*, no longitudinal symmetry is required.

Let $\ell_a < \ell_b$ be the lengths of the two waveguide segments, and \mathbf{S}_{ta} and \mathbf{S}_{tb} , the transmission scattering matrices of the

setup with the ℓ_a and ℓ_b segment, respectively, then

$$\begin{aligned} \mathbf{S}_{ta} &= \mathbf{X}_1 \begin{bmatrix} \exp\{-\gamma(s)\ell_a\} & 0 \\ 0 & \exp\{+\gamma(s)\ell_a\} \end{bmatrix} \mathbf{X}_2 \\ \mathbf{S}_{tb} &= \mathbf{X}_1 \begin{bmatrix} \exp\{-\gamma(s)\ell_b\} & 0 \\ 0 & \exp\{+\gamma(s)\ell_b\} \end{bmatrix} \mathbf{X}_2 \end{aligned} \quad (1)$$

where \mathbf{X}_1 and \mathbf{X}_2 are the transmission scattering matrices of the left and right launchers, respectively, s is the Laplace variable and $\exp\{+\gamma(s)z\}$ is the propagation function of the waveguide for a propagation distance z , $\gamma(s)$ being the propagation constant. In the above equation, the diagonal matrices represent the transmission scattering matrices of the two waveguide segments, which implies that the reference impedances for the waveguide ports coincide with the waveguide characteristic impedance. The matrices \mathbf{S}_{ta} and \mathbf{S}_{tb} can be obtained from the scattering matrices of the two test structures, whereas \mathbf{X}_1 , \mathbf{X}_2 and the propagation function are the unknowns of the problem. Of course, the reference impedances of the wave variables at the launcher ports are the VNA calibration impedance and the waveguide characteristic impedance. The latter, therefore, is a supplemental unknown of the problem.

When \mathbf{X}_2 is computed from the first equation of (1) and replaced into the second one, the following eigenvalue equation for \mathbf{X}_1 arises

$$[\mathbf{S}_{tb}\mathbf{S}_{ta}^{-1}]\mathbf{X}_1 = \mathbf{X}_1 \begin{bmatrix} \lambda_1 & 0 \\ 0 & \lambda_2 \end{bmatrix} \quad (2)$$

where $\lambda_1 = \exp\{-\gamma(s)(\ell_b - \ell_a)\}$ and $\lambda_2 = \exp\{+\gamma(s)(\ell_b - \ell_a)\}$. An analogous equation holds for \mathbf{X}_2 .

For every frequency value, the measured scattering matrices yields six independent parameters (three for each test structure), whereas the unknowns of the problem are the six scattering parameters of the launchers, and the propagation function and the characteristic impedance of the waveguide. The measured data, therefore, do not allow a complete de-embedding of the waveguide responses (*e.g.*, see also [2], [5]). For the inversion problem at hand, however, the eigenvalues of (2) are the samples of the propagation function and, provided the relation between $\gamma(s)$ and the dielectric permittivity is known, they allow to compute the unknown permittivity.

In order to compare the estimation of the propagation function via the double-delay method with the Nicolson-Ross method [1], it is expedient to formulate the latter in terms of transmission scattering matrices. The Nicolson-Ross method uses the scattering responses of one setup only (*e.g.*, the one with the ℓ_a long waveguide), that must be symmetric. The transmission scattering matrix of the measured responses, therefore, is

$$\mathbf{S}_{ta} = \mathbf{X} \begin{bmatrix} \exp\{-\gamma(s)\ell_a\} & 0 \\ 0 & \exp\{+\gamma(s)\ell_a\} \end{bmatrix} \bar{\mathbf{X}} \quad (3)$$

where \mathbf{X} is the transmission scattering matrix of the left launcher and

$$\bar{\mathbf{X}} = \mathbf{P}\mathbf{X}^{-1}\mathbf{P}, \quad \mathbf{P} = \begin{bmatrix} 0 & 1 \\ 1 & 0 \end{bmatrix} \quad (4)$$

that means

$$\mathbf{S}_{ta} = \mathbf{X}\mathbf{D}(\mathbf{P}\mathbf{X}^{-1}\mathbf{P}) \quad (5)$$

where \mathbf{D} is the diagonal matrix of the propagation functions. Besides, the Nicolson-Ross method assumes as launcher a pure impedance discontinuity, *i.e.*,

$$\mathbf{X} = \frac{1}{2Y_o} \begin{bmatrix} (Y_o + Y) & (Y_o - Y) \\ (Y_o - Y) & (Y_o + Y) \end{bmatrix} \quad (6)$$

where Y_o and Y are the characteristic admittance of the measurement system and of the waveguide segment, respectively. This matrix and its inverse are invariant for rows and columns permutations, *i.e.*, $\mathbf{P}\mathbf{X}^{-1}\mathbf{P} = \mathbf{X}^{-1}$. In this case, therefore, the propagation functions are the eigenvalues of \mathbf{S}_{ta} and the Nicolson-Ross method amounts to estimating the waveguide propagation function as the eigenvalues of the transmission scattering matrix of the setup

$$\mathbf{S}_{ta}\mathbf{X} = \mathbf{X}\mathbf{D} \quad (7)$$

In contrast, if this symmetry condition does not hold, then \mathbf{X} and \mathbf{D} are related by

$$(\mathbf{S}_{ta}\mathbf{P})\mathbf{X} = \mathbf{X}(\mathbf{D}\mathbf{P}) \quad (8)$$

and \mathbf{D} cannot be computed from \mathbf{S}_{ta} only.

III. NUMERICAL DE-EMBEDDING EXAMPLES

In order to test the operation and the robustness of the estimation of the propagation function via the double-delay method, we start by applying it to the virtual setup of Fig. 1, that is composed of an ideal LC transmission line and two capacitors. The parameter of the setup are set to $Y_o = 1/50 \Omega^{-1}$ (as in an ideal VNA), $Y = 1/60 \Omega^{-1}$ and $\tau = 0.3$ ns, where τ is the line delay.

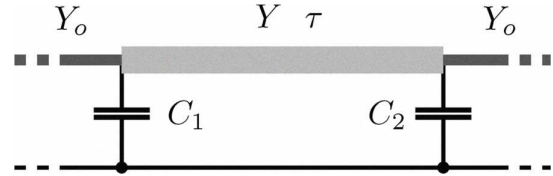

Fig. 1. Setup for the numerical test of de-embedding via the double-delay method. Y and τ are the characteristic admittance of the LC transmission line whose propagation function is being estimated, Y_o is the characteristic admittance of the virtual measurement system.

Figure 2 shows the scattering parameters of the structure of this problem for two cases: $C_1 = C_2 = 0$, *i.e.*, pure impedance discontinuity at the waveguide-VNA interface, (dotted lines), and $C_1 = 1$ pF and $C_2 = 2$ pF (solid lines). The capacitors are a simple way to simulate the effects of possible reactive fields at waveguide-VNA interface. The large difference between the dotted and solid curves suggests that a de-embedding approach based on a pure impedance discontinuity (*i.e.*, the Nicolson-Ross method) is likely to fail for these problems. The difference between the phases of the transmission scattering responses (Fig. 2 bottom panel) is particularly significant, because the phase of the transmission response is closely

related to the waveguide propagation constant and when the capacitors are included the phase is no longer linear with frequency, as expected for pure impedance discontinuities.

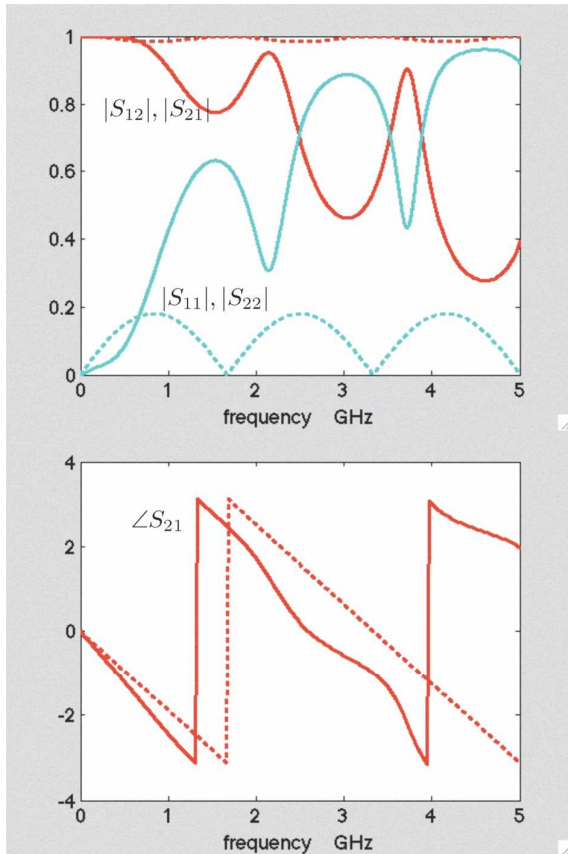

Fig. 2. Magnitude (top panel) and phase (rad, bottom panel) of the scattering functions of the test setup of Fig. 1. Dotted lines hold for pure impedance discontinuities at the waveguide-VNA junctions ($C_1 = C_2 = 0$), solid lines for discontinuities with capacitive effects ($C_1 = 1$ pF and $C_2 = 2$ pF).

For the $C_1 = 1$ pF and $C_2 = 2$ pF case, the propagation function of the ideal transmission line is obtained via the double-delay method by solving (2) with the S_{ta} and S_{tb} matrices corresponding to $\tau = 0.3$ ns and $\tau = 0.6$ ns, respectively. In order to simulate the effect of the measurement noise, the transmission scattering matrices involved in (2) are computed from the scattering matrices of the virtual problem after perturbing their samples with additive gaussian noise. The results of this estimation process are shown in Fig. 3, where the exact and calculated phase of the estimated propagation function are shown along with the estimated waveguide delay normalized to its exact value. The ability of the method to de-embed the propagation function from the scattering responses of the overall structure and the low sensitivity to the measurement noise can be appreciated. The larger noise sensitivity of the estimated delay in the low-frequency range is inherent in the estimation method. In fact, for vanishing frequency the phase rotation of the propagation function tends to zero so that the delay arise from the ratio of two small numbers.

The estimation via the double-delay method works well for symmetric and asymmetric launchers and for fairly arbitrary launcher responses, provided the launchers bandwidth is compatible with the bandwidth of the estimation problem. De-embedding, in fact, cannot overcome the reduction of the signal-to-noise ratio occurring when the launchers have a severe low-pass effect. As an example, if C_1 and C_2 values are increased enough to produce a significant low-pass effect in the measurement bandwidth, then the estimation of the propagation function becomes affected by large noise in the high-frequency region.

In order to test what happens when the Nicolson-Ross method is applied to a problem where launchers do not behave as pure impedance discontinuities, we consider the setup of Fig. 1 with $C_1 = C_2 = 0.5$ pF. In this case, the transmission scattering matrices of the waveguide-VNA junctions does not have the symmetry required by (7) (that is equivalent to the original Nicolson-Ross equations) and its solution leads to wrong results. In particular, for this problem, there are bandwidths where the solution of (7) violate the lossless condition and has no physical meaning. This is a consequence of assuming models of junctions (pure impedance discontinuities) that are not consistent with their actual behavior.

For this problem, the phase of the propagation function obtained from the solution of (7) is shown in Fig. 4 along with the exact phase and the phase of the transmission scattering response of the setup. Where it exists, the estimation of the Nicolson-Ross method (black dots) traces the phase of the scattering transmission responses, affected by the capacitors contributions, and not the actual phase response of the transmission line. Besides, the existence domain of the solution reduces as the capacitance value is increased, making the method not appropriate to problems where capacitive launcher effects take place.

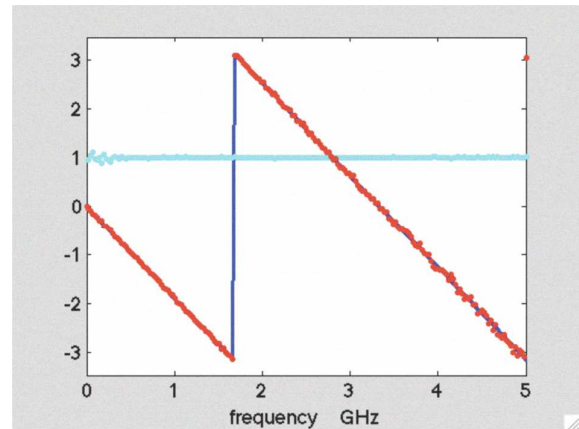

Fig. 3. Delay (horizontal curve) and phase (sloped curve, rad) of the propagation function (continuous line: reference; dots: estimated values) of the test setup of Fig. 1 with $C_1 = 1$ pF and $C_2 = 2$ pF. The noise added to the exact scattering matrices of the structure has a standard deviation 0.01 and the estimated delay is normalized to the exact value.

IV. APPLICATION EXAMPLES

In order to verify the performance of the double-delay method on real measurement problems, we apply it to the estimation of the permittivity of an FR4 board and of a sample of polyammidic resin included in a coaxial waveguide.

A. Permittivity of an FR4 board

A standard procedure to measure the permittivity of a Printed Circuit Board (PCB) is to add a test trace to the design and to estimate the unknown permittivity from the transmission scattering response of the trace. Usually the trace is connected to the VNA via SMA connectors, leading to the de-embedding problem addressed here.

For this test, we use a PCB containing two microstrip traces that are 1.5 inch and 3 inch long. The traces have $w/h = 2$ and are terminated by SMA connectors. The setup used is shown in Fig. 5 and the scattering parameters measured for its short trace structure are shown in Fig. 6. It is ought to remark the similarity of these responses to the responses of the virtual problem with capacitive junctions shown in Fig. 2.

When the double-delay method is applied to the scattering parameters and the estimated propagation function is inverted, the relative permittivity of Fig. 7 results. This estimation leads to a high frequency real part of the relative permittivity value equal to 4.25, that coincides with the nominal value of the material used, and to $\tan \delta = 0.023$, that is the value expected for FR4. The estimated curves are pretty smooth and free of noise also in the high-frequency part of the measurement, that extends up to 8.5 GHz. It is also worth noticing that the loss parameter, that is very sensitive, is estimated correctly.

B. Permittivity of a polyammidic resins

The permittivity of resins is often obtained by filling with them a coaxial waveguide and by measuring the scattering responses of the filled waveguide. In order to avoid the need

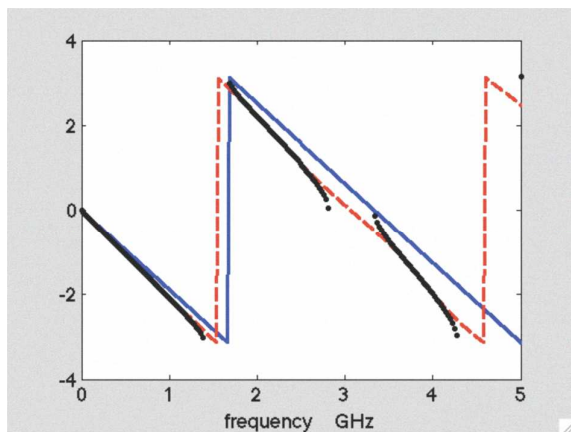

Fig. 4. Phase curves (rad) for the test setup of Fig. 1 with $C_1 = C_2 = 0.5$ pF. Continuous line: phase of the actual propagation function of the transmission line; Dashed line: phase of the transmission scattering response of the setup; Dots: phase of the propagation function estimated by the Nicolson-Ross equations (see text in Sec. III).

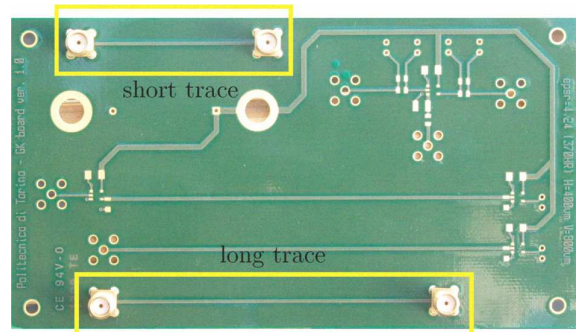

Fig. 5. Setup for the measurement of the permittivity of an FR4 PCB. The frames highlight the two traces with SMA connectors used for the double-delay method. Along the right edge of the board it is visible the relative permittivity value declared by the manufacturer: 4.24.

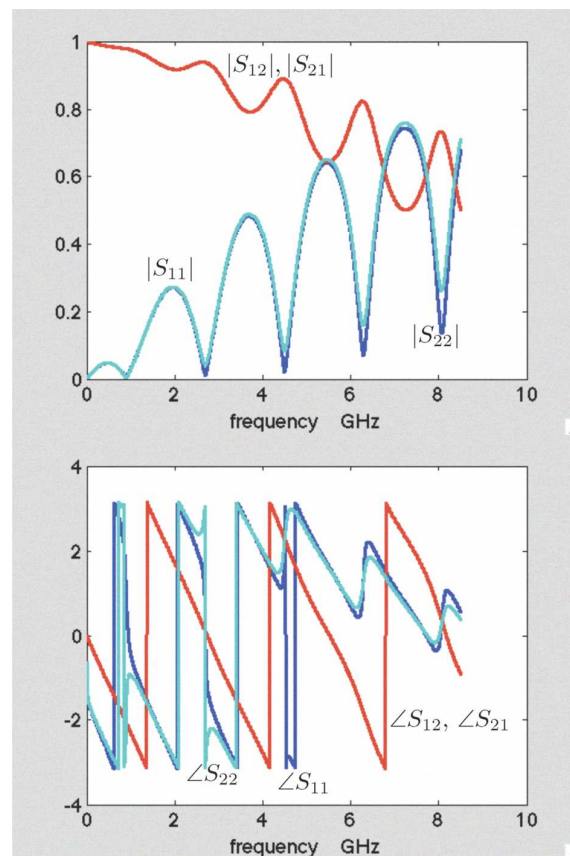

Fig. 6. Magnitude (top panel) and phase (rad, bottom panel) of the measured scattering functions for the short microstrip trace with SMA connectors of Fig. 5.

for two dielectric samples of different lengths and for two coaxial waveguides, we use a modified version of the double-delay method. Our technique is based on the setup of Fig. 9. In this setup, a calibrated coaxial airline, in which a cylindrical sample of the dielectric under test can be introduced, is fed via two identical APC7-SMA connectors.

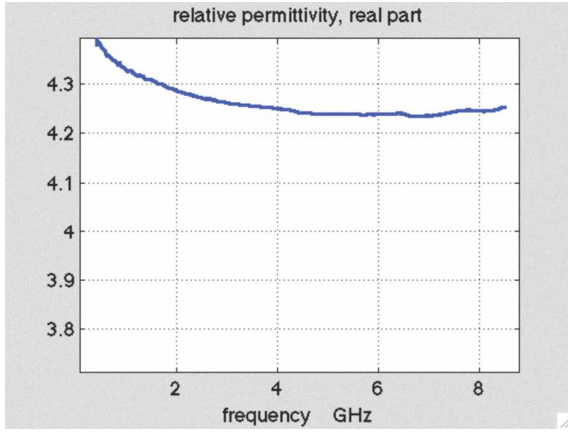

Fig. 7. Real part of the relative permittivity estimated for the FR4 PCB of Fig. 5 via the double-delay method. The curve is represented on an expanded vertical scale.

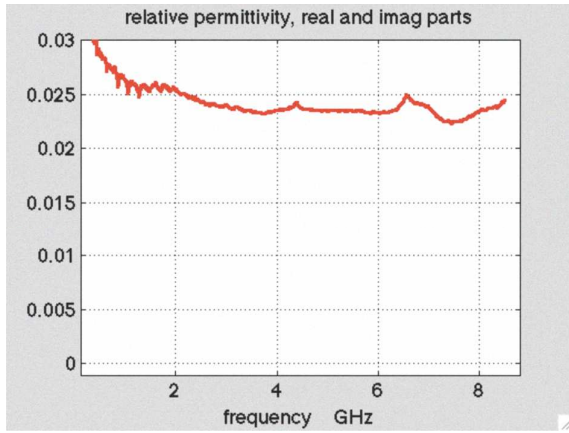

Fig. 8. $\tan \delta$ of the permittivity estimated for the FR4 PCB of Fig. 5 via the double-delay method.

The estimation technique exploits the scattering responses of the empty airline and of the airline with a short cylindrical sample in its center (see Fig. 9). The transmission scattering response of the empty airline is

$$\mathbf{S}_{te} = \mathbf{X} \mathbf{D}_\ell \bar{\mathbf{X}} \quad (9)$$

where \mathbf{X} and $\bar{\mathbf{X}}$ represent the transmission scattering matrix of the two identical APC7 connectors and

$$\mathbf{D}(\ell) = \begin{bmatrix} \exp\{-s\ell/c\} & 0 \\ 0 & \exp\{+s\ell/c\} \end{bmatrix} \quad (10)$$

is the transmission scattering matrix of the airline, c being the light speed and ℓ the length of the airline (see Fig. 9). Similarly, the transmission scattering response of the airline with the cylindrical dielectric sample can be written as

$$\mathbf{S}_t = \mathbf{X} \mathbf{D}(d) [\Xi \mathbf{U} \Xi^{-1}] \mathbf{D}(d) \bar{\mathbf{X}} \quad (11)$$

where $\mathbf{D}(d)$ is the transmission scattering matrix of the empty airline parts that trail and lead the dielectric sample, Ξ is the

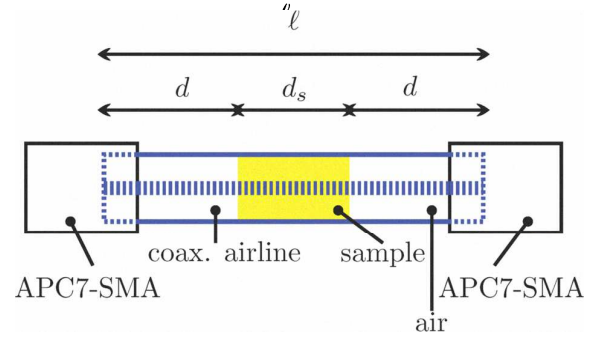

Fig. 9. Setup for the measurement of the permittivity of resin samples by means of a coaxial waveguide. The waveguide is a Maury Microwave Airline, model no. 2653S10, with $\ell = 105$ mm. The solid rectangle represents the cylindrical dielectric sample under test that is inserted in the airline.

transmission scattering matrix of the interface between the air and the dielectric sample and \mathbf{U} is the diagonal matrix with the propagation function of the dielectric sample to be estimated. The above equation takes into account that the behavior of the connectors is not affected by the insertion of the dielectric sample and that the interface between the empty and filled airline is a pure impedance discontinuity so that $\mathbf{P} \Xi^{-1} \mathbf{P} = \Xi^{-1}$ (see Sec. II). Since the propagation function of the calibrated airline is known, the estimation technique uses (9) to estimate the response of the connectors \mathbf{X} and replaces it into (11) to estimate \mathbf{U} .

According to (8), the response of connectors is the solution of

$$(\mathbf{S}_{te} \mathbf{P}) \mathbf{X} = \mathbf{X} (\mathbf{D}(\ell) \mathbf{P}) \quad (12)$$

This equation can be solved by using the diagonal representation of the operator $\mathbf{D}(\ell) \mathbf{P}$

$$\mathbf{D}(\ell) \mathbf{P} = \mathbf{u} \begin{bmatrix} -1 & 0 \\ 0 & +1 \end{bmatrix} \mathbf{u}^{-1} \quad (13)$$

with

$$\mathbf{u} = \begin{bmatrix} -1 & 1 \\ \exp\{s\ell/c\} & \exp\{s\ell/c\} \end{bmatrix} \quad (14)$$

The following eigenvalue equation then holds

$$(\mathbf{S}_{te} \mathbf{P})(\mathbf{X} \mathbf{u}) = (\mathbf{X} \mathbf{u}) \begin{bmatrix} -1 & 0 \\ 0 & +1 \end{bmatrix} \quad (15)$$

and \mathbf{X} is given by

$$\mathbf{X} = \mathbf{v} \mathbf{n} \mathbf{u}^{-1} \quad (16)$$

where \mathbf{v} is the matrix of the eigenvectors of (15) and \mathbf{n} is an unknown diagonal normalization matrix.

Unfortunately, the knowledge of \mathbf{S}_{te} is not sufficient to compute \mathbf{n} and then to identify \mathbf{X} completely. However, equation (16) can be used to compute the transmission scattering matrix of the setup with the empty airline for an arbitrary length of the airline, because in such computation \mathbf{n} does not contribute, e.g., in

$$\mathbf{S}_{tv} = \mathbf{X} \mathbf{D}(2d) \bar{\mathbf{X}} \quad (17)$$

$$= \mathbf{v} \mathbf{n} \mathbf{u}^{-1} (\mathbf{D}(2d) \mathbf{P}) \mathbf{u} \mathbf{n}^{-1} \mathbf{v}^{-1} \mathbf{P} \quad (18)$$

\mathbf{n} and \mathbf{n}^{-1} simplify and \mathbf{S}_{tv} is the transmission scattering matrix of the setup with the empty airline if the airline length were $2d$. We use \mathbf{S}_{tv} to eliminate $\bar{\mathbf{X}}$ from (11), obtaining the following eigenvalue equation for \mathbf{U}

$$\begin{aligned} \mathbf{S}_t &= \mathbf{X} \mathbf{D}(d) [\boldsymbol{\Xi} \mathbf{U} \boldsymbol{\Xi}^{-1}] \mathbf{D}(d) \mathbf{D}(-2d) \mathbf{X}^{-1} \mathbf{S}_{tv} \\ (\mathbf{S}_t \mathbf{S}_{tv}^{-1}) (\mathbf{X} \mathbf{D}(d) \boldsymbol{\Xi}) &= (\mathbf{X} \mathbf{D}(d) \boldsymbol{\Xi}) \mathbf{U} \end{aligned} \quad (19)$$

In summary, the modified double-delay estimation can be outlined as follows

- (i) measure \mathbf{S}_{te} and \mathbf{S}_t
- (ii) solve (15), compute $\mathbf{X} = \mathbf{v} \mathbf{u}^{-1}$ and \mathbf{S}_{tv} via (17)
- (iii) compute \mathbf{U} by solving the eigenvalue equation (19)

We test this technique on a polyammidic resin sample with $d_s = 20$ mm and the setup of Fig. 9. The sample has been built to closely fit the coaxial structure and to have end surfaces orthogonal to the axis of the structure. The magnitude of the scattering responses measured for the empty airline and the airline with the dielectric sample are shown in Fig. 10. The distortion effects of the connectors can be clearly appreciated. The application of the proposed estimation technique to these measured data leads to the permittivity curves shown in Fig. 11. Again the double-delay approach is able to detect the real part of the permittivity and leads to a real part of the permittivity that is close to the value expected for our polyammidic dielectric sample.

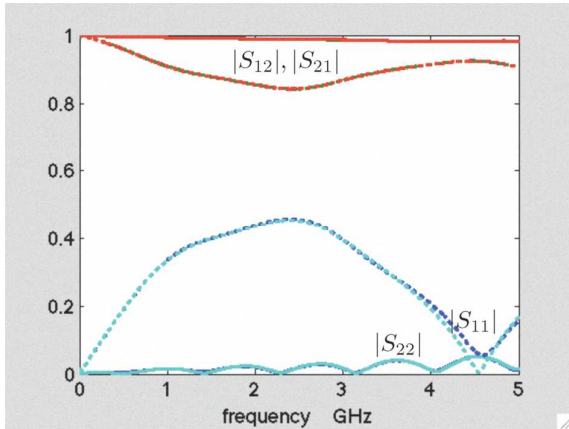

Fig. 10. Magnitude of the scattering functions measured for the setup of Fig. 9. Continuous and dotted lines represent the response of the setup for empty waveguide and for the cylindrical sample included in the waveguide, respectively.

V. CONCLUSION

The estimation of permittivity from the scattering responses of setups composed of a uniform waveguide and its launchers has been addressed by means of the double-delay method. When the launchers do not behave as pure characteristic impedance discontinuities, the estimation of the waveguide propagation function of the waveguide via the Nicolson-Ross equation can lead to large errors and unphysical solutions. In contrast, the double-delay approach allows to handle launchers

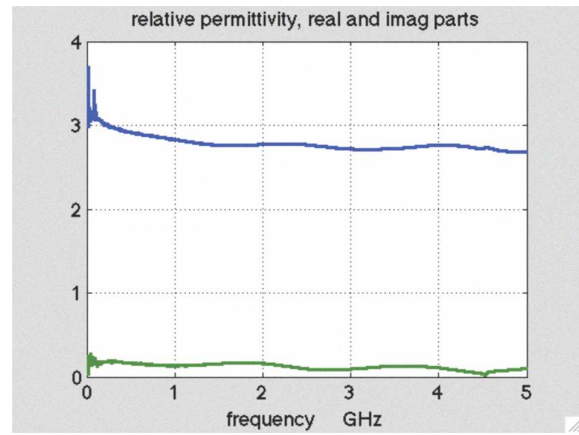

Fig. 11. Real (upper curve) and imaginary (lower curve) parts of the relative permittivity estimated from the scattering responses of Fig. 10 via the double-delay method modified as proposed in this paper.

with fairly arbitrary behaviors, possibly different at the two waveguide ends. Besides, the double-delay approach can be easily modified to work with setups that facilitate the measurement process. In summary the double-delay approach is an effective tool for a careful estimation of the permittivity of dielectric materials from scattering measurements.

ACKNOWLEDGMENT

The Authors would like to thank Dr. Luca Rigazio and Prof. Andrea Ferrero of Politecnico di Torino for carrying out the measurements exploited in this study.

REFERENCES

- [1] A. M. Nicolson and G. F. Ross. Measurement of the intrinsic properties of materials by time-domain techniques. *IEEE Trans. on Instr. and Measurement*, IM-19(4):377–402, Nov 1970.
- [2] J. C. Rautio. A de-embedding algorithm for electromagnetics. *International Journal of Microwave and Millimeter-Wave Computer-Aided Engineering*, 1(3):282–287, 1991.
- [3] M. Farina, A. Morini, and T. Rozzi. A calibration approach for the segmentation and analysis of microwave circuits. *IEEE Trans. on Microwave Theory and Techniques*, 55(10):2124–2134, 2007.
- [4] S. Agili, V. Balasubramanian, and A. Morales. De-embedding techniques in signal integrity: a comparison study. *2005 Conference on Information Sciences and Systems*, pages 1–6, Feb 2005.
- [5] J. M. Song, F. Ling, W. Blood, E. Demircan, K. Sriram, G. Flynn, K. H. To, R. Tsai, Q. Li, and T. Myers. De-embedding techniques for embedded microstrips. *Microwave and Optical Technology Letters*, 42(1), 2004.