

A Remotely Controlled Calibrator for Chemical Pollutant Measuring-Units

*Original*

A Remotely Controlled Calibrator for Chemical Pollutant Measuring-Units / Carullo, Alessio; Corbellini, Simone; Grassini, Sabrina. - In: IEEE TRANSACTIONS ON INSTRUMENTATION AND MEASUREMENT. - ISSN 0018-9456. - STAMPA. - 56:4(2007), pp. 1212-1218. [10.1109/TIM.2007.899916]

*Availability:*

This version is available at: 11583/1650922 since:

*Publisher:*

IEEE / Institute of Electrical and Electronics Engineers Incorporated:445 Hoes Lane:Piscataway, NJ 08854:

*Published*

DOI:10.1109/TIM.2007.899916

*Terms of use:*

This article is made available under terms and conditions as specified in the corresponding bibliographic description in the repository

*Publisher copyright*

(Article begins on next page)

# A Remotely Controlled Calibrator for Chemical Pollutant Measuring-Units

Alessio Carullo, Simone Corbellini, and Sabrina Grassini

**Abstract**—The increasing diffusion of pollutant measuring units, which are installed over wide areas, along with the short calibration interval of several sensors for pollutant quantities, requires new calibration infrastructures to be developed. This paper describes an attempt to develop an innovative calibration system which is based on traveling standards and which does not require units to be removed from the measuring site during the calibration process. The calibration system is based on a traveling standard, which is composed of one or more cylinders that contain gas mixtures, a cell with standard sensors, and a control unit with networking capabilities, which allows the traveling standard to be remotely exercised. A prototype of the proposed system is described and the preliminary results reported.

**Index Terms**—Calibration, environmental factors, interconnected systems, large-scale systems, measurement standards.

## I. INTRODUCTION

THE ATTENTION toward the risks that are related to exposure to chemical pollution is rapidly increasing, because of the direct correlations that have been established among pollutants and human diseases. For this reason, a continuous monitoring of the different pollutants is often implemented, and obtained pollutant levels are compared with attention and alarm thresholds in order to highlight possible dangerous situations.

Monitoring of chemical pollutants is usually performed by means of systems that are based on a distributed architecture: Different measuring units are interconnected in a wired or wireless data network and remotely managed by means of a central control unit. In such a way, the data the different units provide can be collected and processed in real-time, thus allowing dedicated algorithms to be implemented that interpolate the pollutant levels among different units or provide a sort of “pollutant forecast” [1]–[3]. Furthermore, the distributed architecture allows large geographical areas to be monitored, especially when the Internet is employed as the network support.

A common problem of existing monitoring networks is poor spatial density, which is mainly due to the high investment that is required to activate the measuring units. Each unit is indeed a set of expensive chemical analyzers that are very similar to those employed in a chemical laboratory. Such analyzers employ different measuring techniques, such as chemiluminescence for  $\text{NO}_x$ , nondispersive cross modulation infrared analysis for carbon monoxide (CO), and molecular fluorescence

for  $\text{SO}_X$ . Furthermore, high management costs have to be considered that are mainly due to the periodical calibration of each analyzer.

With the aim to solve such problems, many researchers have developed simpler devices for pollutant detection, which are now commercially available as electrochemical and solid-state sensors. The most interesting features of such devices are their low cost and small size, while the main drawback is a poor selectivity, since their output is affected by different kinds of gases. Cheap and compact measuring units can be therefore arranged, which usually employ sensors that sense different target gases, thus allowing the different outputs to be suitably processed in order to improve the gas selectivity [4], [5]. Another interesting application of such sensor-based measuring units is the monitoring of urban areas, which is performed by placing the units on vehicles running on the streets. In this case, some solutions are proposed for verifying the metrological characteristics of the involved devices [6], [7].

Like the chemical-analyzer-based units, also the sensor-based units require a frequent calibration that makes their management expensive. The distributed architecture further complicates the calibration procedure, since the acquisition and processing programs that are involved in the measuring path also have to be verified. In order to simplify the metrological management of such kinds of systems, the authors of [8] have suggested a procedure that requires the availability of remotely controlled traveling standards [9], which are sent to the different units and controlled by means of the central control unit. The calibration results the central unit acquires can be eventually employed to perform the metrological confirmation of the whole measuring system [10].

Unfortunately, traveling standards that are able to generate known gas concentration are not commercially available, thus preventing the remote calibration technique to be performed. For this reason, the authors have designed a traveling standard that can be employed for the remote calibration of sensor-based pollution measuring units [11].

## II. TRAVELING STANDARD

The proposed traveling standard, whose basic architecture is shown in Fig. 1, mainly consists of a control unit, a gas cylinder, and a calibration cell.

The calibration cell is a sealed chamber where known gas concentrations are generated. It is made up of a central body of cylindrical shape and of two removable circular stoppers. One stopper, which will be referred to as “reference head,” is a component of the traveling standard and is equipped with a

Manuscript received June 15, 2006; revised April 4, 2007.

A. Carullo and S. Corbellini are with the Dipartimento di Elettronica, Politecnico di Torino, 10129 Torino, Italy (e-mail: alessio.carullo@polito.it).

S. Grassini is with the Dipartimento di Ingegneria Chimica e Scienza dei Materiali, Politecnico di Torino, 24-10129 Torino, Italy.

Digital Object Identifier 10.1109/TIM.2007.899916

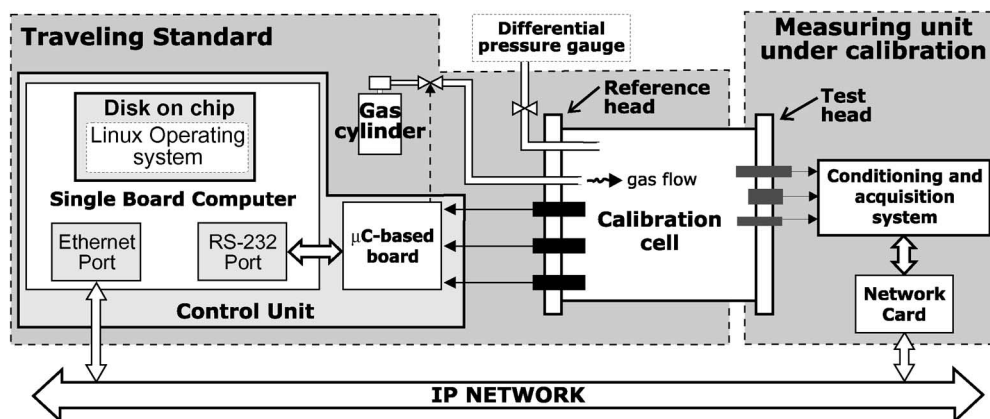

Fig. 1. Architecture of the traveling standard for the calibration of sensor-based pollution measuring-units. The differential pressure gauge is employed only during the calibration of the reference head.

set of standard sensors of gas concentration, temperature, and humidity. The measurements such devices provide represent the reference values for the sensors under calibration. The other stopper, known as the “test head,” embeds the sensors under calibration, and therefore, it belongs to the pollutant measuring unit. A measuring unit can be therefore remotely calibrated if its measuring head can be adapted to the calibration cell. Furthermore, in order to apply the calibration procedure proposed in the next section, the measuring unit has to access to the network, as highlighted in Fig. 1.

The control unit has to offer networking capabilities to allow the traveling standard to be remotely programmed and processing capabilities to permit the estimation of the reference values of gas concentration, temperature, and humidity from the output signals of the standard sensors.

A cylinder that contains a gas mixture is connected to the calibration cell through an electromechanical valve, which is controlled by the control unit. This allows approximately known volumes of gas mixture to be introduced into the cell so that different concentrations can be generated, whose values are measured by means of the gas standard sensor. The proposed scheme can be easily extended by employing different gas cylinders, thus allowing the verification of different sensors or the cross-sensitivity of a single sensor to be verified.

#### A. *Traveling-Standard Prototype*

The prototype the authors have developed has been specialized for the calibration of pollutant-measuring units that detect the concentration of CO and nitrogen dioxide ( $\text{NO}_2$ ). The reference head embeds two thick-film metal-oxide-semiconductor devices (Figaro models TGS2106 e TGS2442), whose basic principle is the resistance change due to the concentration change of the target gas that is chemically adsorbed and desorbed on the sensor surface. The resistance changes of the two sensors are converted into voltage changes by means of two simple voltage dividers.

The signal outputs of the two sensors also depend on the temperature, which affects the chemical reaction on the sensor surface, and on the relative humidity, since the water vapor adsorbed on the sensor surface results in a resistance change. For this reason, the reference head also embeds a temperature

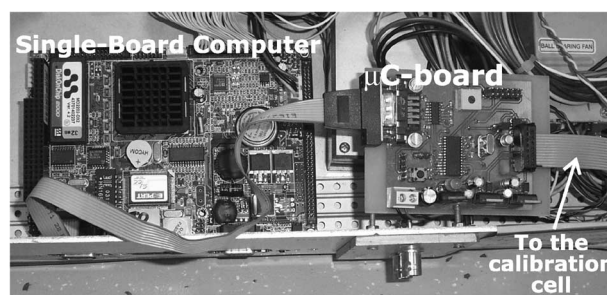

Fig. 2. Photograph of the single-board computer connected to the microcontroller-based board.

sensor (National Semiconductor model LM35) and a relative humidity sensor (Humirel model HM1500), thus allowing the effects of these quantities on the gas sensors to be compensated.

The reference head is equipped with two quick gas connectors that are employed to insert a gas mixture into the cell and to connect a pressure gauge. The gas mixture, which has a known concentration, is contained into a cylinder; the pressure gauge is employed only during the calibration of the standard sensors, as explained later.

The control unit is based on an EX9529 embedded single board computer (SBC) and on a dedicated measuring board. The former is a general-purpose computer which operates in a Linux environment. Thanks to both the 32-MB disk-on-chip and the embedded LAN 100/10M interface, such a computer is able to communicate with a central server and allows the standard to be remotely programmed. The second board is instead an application-specific measuring system, which performs both the measurements of gas concentration inside the calibration cell and the control of the gas flow. These functions are achieved by means of a microcontroller device (PIC18F2620 by Microchip) and its embedded devices.

Fig. 2 shows the SBC connected to the microcontroller board ( $\mu\text{C}$ -board) by means of an RS-232C interface. The board includes a few voltage regulators that are necessary to provide the power for heating the gas sensors. The timers of the microcontroller are employed in order to provide specific heating pulses and perform the measurement sequence that is required by the CO sensor [12]. The output of all the sensors are first amplified and then acquired by the analog-to-digital converter

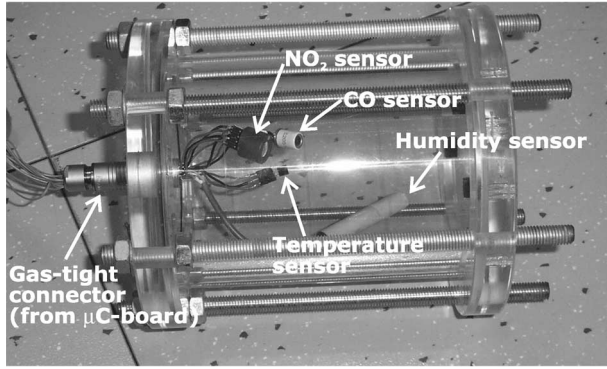

Fig. 3. Plexiglass calibration-cell of the traveling standard.

of the microcontroller, which employs 10 bits of resolution. Such a resolution corresponds to a maximum quantization uncertainty of about 0.25 °C for the temperature and 0.1% RH for the relative humidity. The quantization uncertainty for the concentration measurements depends on the sensitivity of the gas sensor and can be as low as 0.1% of the measuring range.

Fig. 3 shows the prototype of calibration cell, which is made of plexiglass. The sensor connections are obtained by means of a gas-tight connector.

### III. CALIBRATION PROCEDURES

The proposed traveling standard is suitable for calibrating single pollutant measuring units, as well as large distributed systems.

When a single measuring unit has to be verified, the traveling standard is sent to the unit site and is remotely controlled in order to apply known gas concentrations to the unit sensors. The measurements the unit provides are then acquired and compared with the reference values in order to perform the metrological confirmation of the measuring unit. One should note that expert technicians are not required at the unit site, thus drastically reducing calibration costs.

If a distributed system has to be verified, the calibration procedure depends on the measuring task the system performs. If the system is a set of independent measuring units, i.e., when the central control unit only configures the different units and acquires the measured data, the same procedure employed for a single unit can be implemented for each unit at a time. If the central control unit instead performs some forms of processing that involve measurements that different units provide, a distributed calibration procedure can be implemented. Such a procedure requires the availability of different traveling standards ( $TS_1, \dots, TS_N$ ) that are sent to the different units and remotely controlled by the central unit, as shown in Fig. 4.

The traceability of the measurements the traveling standard provides is assured by calibrating the standard sensors without removing them from the reference head. The traceability chain is summarized in Fig. 5.

Initially, the reference head is inserted into a climatic chamber, and temperature and humidity sensors are calibrated against traceable devices. Then, the calibration cell is sealed by means of a stopper and a gas mixture with a known concentration is introduced into the cell. Since the gas mixture is

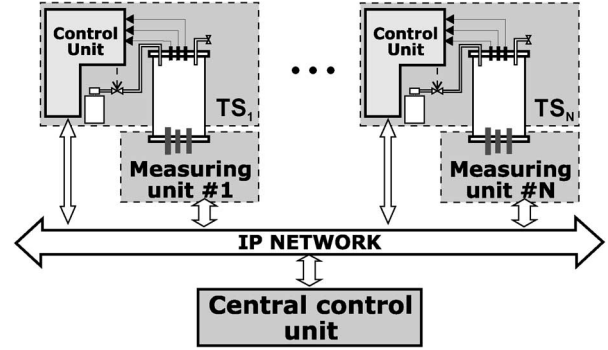

Fig. 4. Distributed calibration procedure performed by employing  $N$  traveling standards.

introduced into a cell that has a constant volume, it is possible to express the generated gas-concentration  $c_g$  inside the cell as

$$c_g = c_v \cdot \frac{T_g}{P_g} \cdot \left( \frac{P_g}{T_g} - \frac{P_0}{T_0} \right) \quad (1)$$

where  $P_0$  and  $T_0$  are pressure and temperature inside the cell at the initial conditions,  $P_g$  and  $T_g$  are pressure and temperature inside the cell after the insertion of a certain amount of gas mixture, and  $c_v$  is the volume gas-concentration inside the cylinder. The previous equation is valid for gases that normally have a negligible concentration in the air, e.g., CO and NO<sub>2</sub>.

If the temperature is subjected to negligible changes during the sensor calibration, i.e., if  $T_g \approx T_0$ , (1) becomes

$$c_g = c_v \cdot \left( 1 - \frac{P_0}{P_g} \right) \quad (2)$$

that can be rewritten as

$$c_g = c_v \cdot \left( 1 - \frac{1}{1 + \frac{\Delta P}{P_0}} \right) \quad (3)$$

where  $\Delta P$  is the pressure increase inside the cell that is due to the inserted gas mixture, which is measured by means of a differential pressure gauge (see Fig. 1).

If the initial pressure  $P_0$  is known with negligible uncertainty, the standard uncertainty  $u(c_g)$  of the gas concentration generated inside the calibration cell can be expressed as [13]

$$u^2(c_g) = \left( 1 - \frac{1}{1 + \frac{\Delta P}{P_0}} \right)^2 \cdot u^2(c_v) + \frac{(c_v \cdot P_0)^2}{(P_0 + \Delta P)^4} \cdot u^2(\Delta P) \quad (4)$$

where the gas concentration inside the cylinder and the pressure measurements have been considered uncorrelated quantities, i.e.,  $\rho(c_v, \Delta P) = 0$ .

For the calibration of the gas sensors of the developed prototype, the authors have employed two different gas cylinders with traceable concentration of CO ( $c_v = 396$  ppm,  $u(c_v) = 4$  ppm) and NO<sub>2</sub> ( $c_v = 54$  ppm,  $u(c_v) = 0.7$  ppm) and a differential pressure gauge with a range of 130 mbar and a standard uncertainty of 0.3 mbar at the full range. As an example, Fig. 6 shows the achievable concentration of NO<sub>2</sub> inside the calibration cell and the corresponding relative standard uncertainty

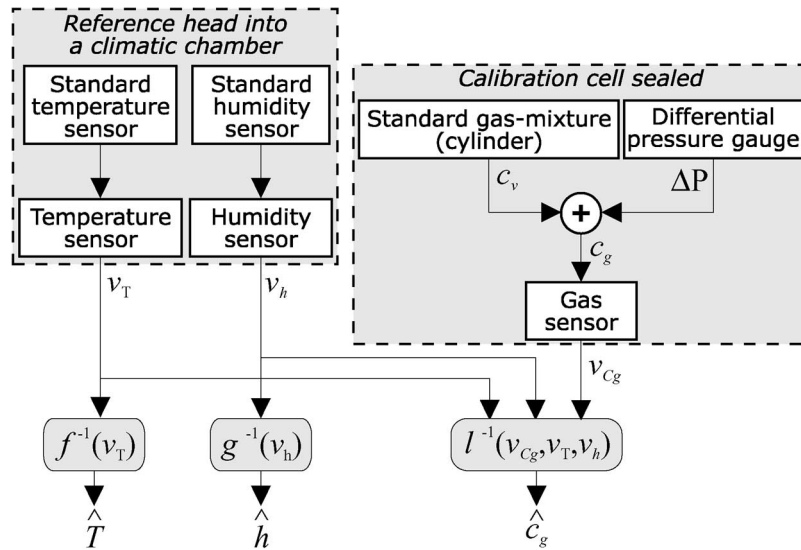
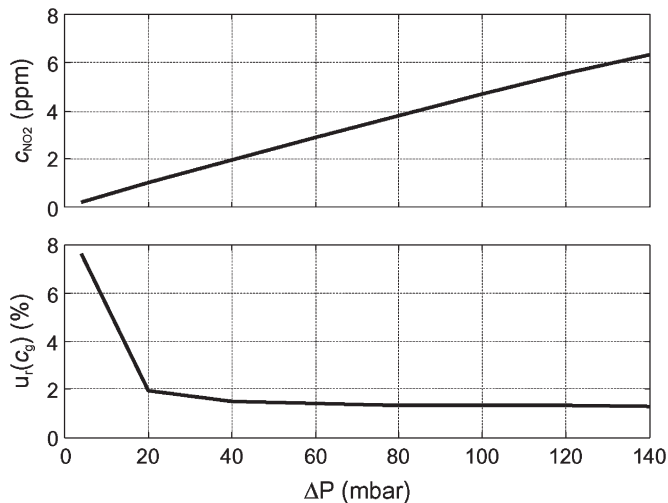

Fig. 5. Traceability chain of the traveling standard.

 Fig. 6. Achievable concentration of  $\text{NO}_2$  and corresponding relative standard uncertainty.

that has been estimated by considering the initial pressure  $P_0$  equal to the atmospheric pressure.

The output signals the standard sensors provide for different gas concentrations and different temperature and humidity values are measured by means of the control unit. In such a way, the calibration of the whole measuring chain is performed, since also the measuring hardware and the processing software are involved in the calibration process. The acquired signals are then employed in order to estimate the calibration function  $l^{-1}$  of each gas sensor, i.e., the relationship that allows one to obtain a gas-concentration estimation  $\hat{c}_g$  from the output voltages of temperature, humidity, and gas sensors, as highlighted in Fig. 5.

Alternatively, if a discrete number of *a priori* known gas concentrations has to be generated, the traveling standard can be characterized by means of a calibration table. Such a table can be built by generating such gas concentrations and storing the corresponding voltage outputs. During the use of the traveling standard, in order to reproduce the same gas concen-

trations, a gas mixture is introduced into the calibration cell until the stored voltage outputs are obtained. In such a way, lower uncertainties can be obtained, since the performance of the traveling standard is not affected by the deviation of the estimated calibration function with respect to the real behavior of the sensors. When a calibration table is employed, the main uncertainty contributions are the ones related to the short-term stability of measuring hardware and standard sensors.

#### IV. EXPERIMENTAL RESULTS

The reported experimental results refer to the  $\text{NO}_2$  and CO sensors of the reference head. Such sensors have to be characterized from a metrological point of view, since the manufacturer specifications are not suitable as calibration functions: The sensor resistances in clean air, as well as their sensitivities with respect to the gas concentration, are stated as large intervals, thus indicating a poor reproducibility among different sensors.

Initially, the sensor sensitivities in air with respect to the influence quantities have been estimated by placing the calibration cell inside a climatic chamber and acquiring the sensor outputs at different levels of temperature and relative humidity. Different tests have been performed in the temperature range of  $10^\circ\text{C}$ – $30^\circ\text{C}$  at a fixed humidity (40% RH) and in the humidity range of 20% to 60% RH at a fixed temperature ( $23^\circ\text{C}$ ). The obtained results for the  $\text{NO}_2$  sensor are shown in Figs. 7 and 8. The estimated sensitivities are of about  $-0.1 \text{ k}\Omega(^{\circ}\text{C})^{-1}$  with respect to the temperature and of about  $-0.12 \text{ k}\Omega(\% \text{RH})^{-1}$  with respect to the relative humidity.

Then, the sensor sensitivities with respect to the gas concentration have been estimated by implementing the calibration technique described in the Section III. Fig. 9 shows the obtained results for the  $\text{NO}_2$  sensor during a test session in the concentration range of 0–5.5 ppm: The obtained sensitivity with respect to the concentration of  $\text{NO}_2$  is of about  $4.3 \text{ k}\Omega(\text{ppm})^{-1}$ , while the time constant of the sensor is of about 20 s.

The obtained results allow a preliminary estimation of the expected uncertainty to be obtained. If the sensor resistance is

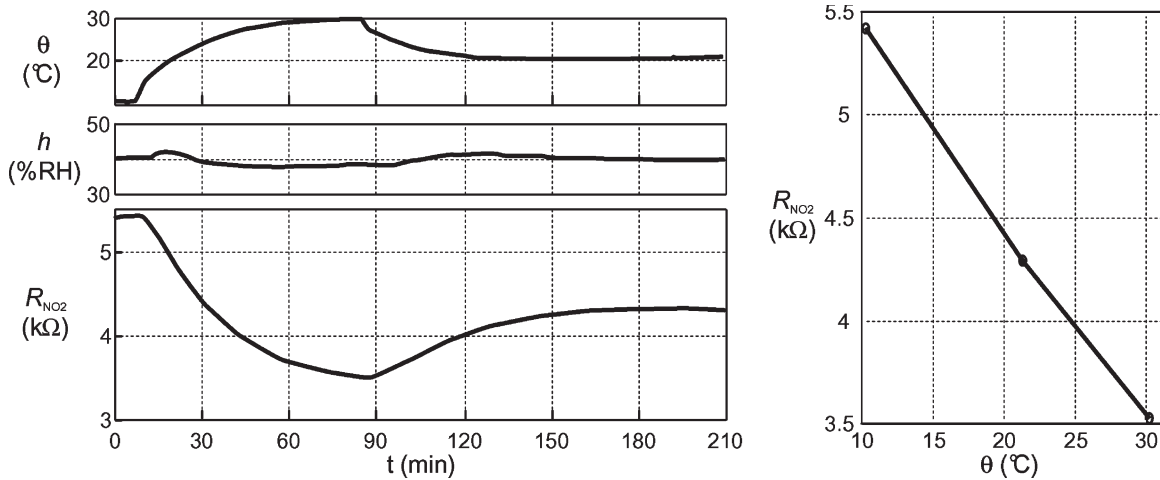

Fig. 7. Results obtained during a test for the estimation of the  $\text{NO}_2$  sensor output with respect to the temperature.

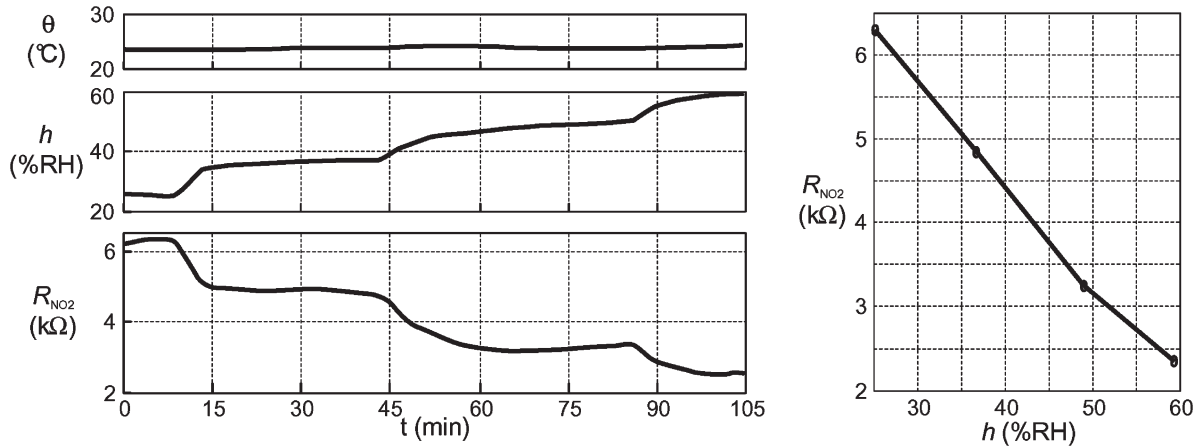

Fig. 8. Results obtained during a test for the estimation of the  $\text{NO}_2$  sensor output with respect to the relative humidity.

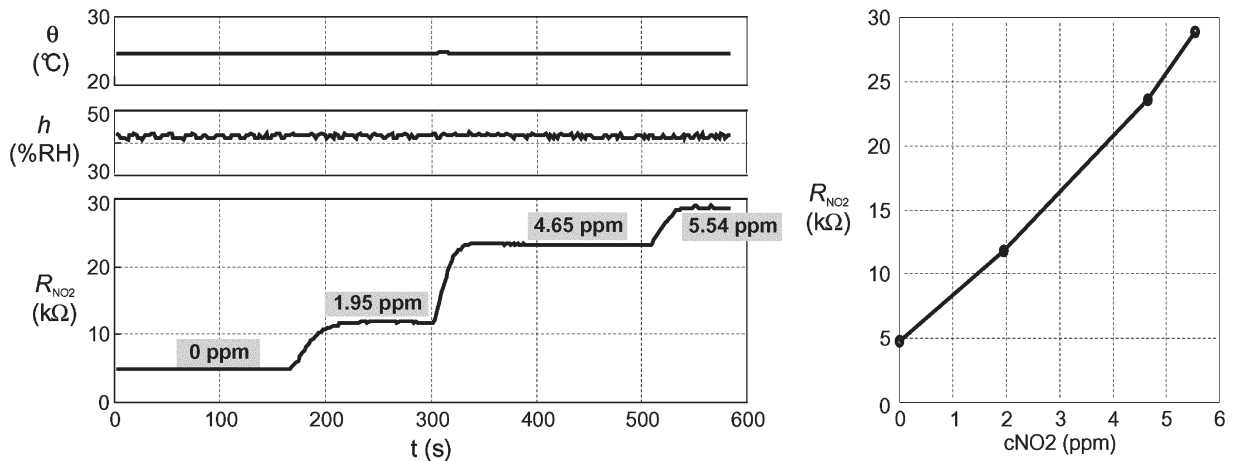

Fig. 9. Example of results obtained during a calibration session of the  $\text{NO}_2$  sensor.

measured with a standard uncertainty of 0.1  $\text{k}\Omega$  and the uncertainty of the influence quantities is of 1  $^{\circ}\text{C}$  for the temperature and 2% RH for the relative humidity, the  $\text{NO}_2$  concentration can be estimated with a standard uncertainty of less than 0.1 ppm. Other uncertainty contributions that have to be taken into account are the calibration uncertainty and the sensor drift. The former does not affect the total uncertainty in a significant

way, since its value reaches 0.1 ppm only for concentration of  $\text{NO}_2$  higher than 6 ppm (see Fig. 6). The latter is now under investigation, since it requires more tests for its estimation.

The same tests have been performed for the CO sensor. As an example, Fig. 10 shows the results that refer to the behavior in air of the sensor output with respect to the temperature at a fixed relative humidity (60% RH). The estimated sensitivities with

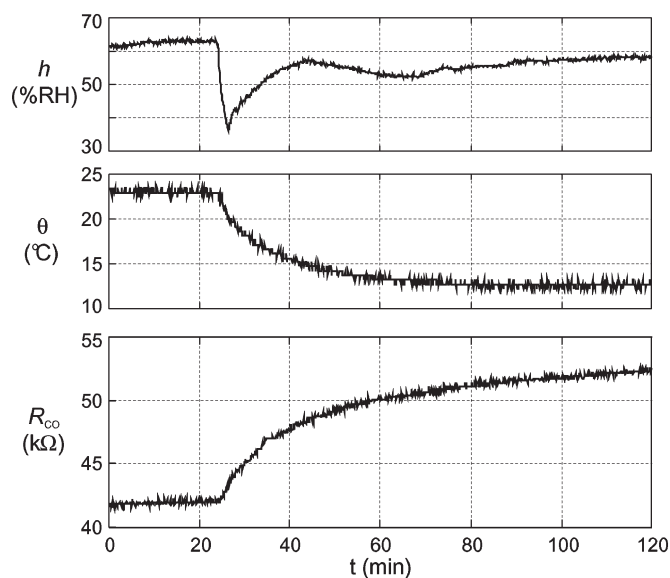

Fig. 10. Results obtained during a test for the estimation of the CO sensor output with respect to the temperature.

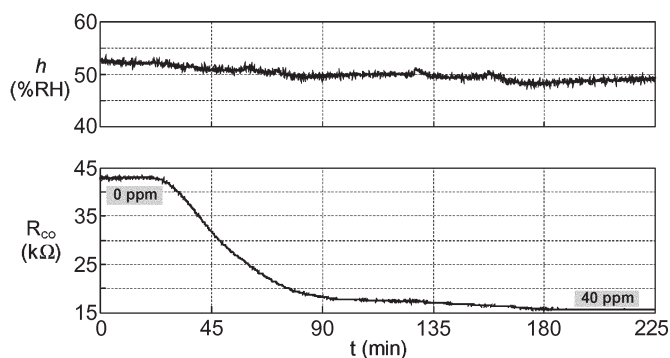

Fig. 11. Example of results obtained during a calibration session of the CO sensor.

respect to the influence quantities are  $-0.9 \text{ k}\Omega(\text{C}^\circ)^{-1}$  for the temperature and  $-0.05 \text{ k}\Omega(\%RH)^{-1}$  for the relative humidity. Fig. 11 shows the resistance output of the CO sensor during a calibration session that has been performed in the concentration range of 0–40 ppm at a temperature of about  $23 \text{ C}^\circ$ .

## V. CONCLUSION

The traveling standard proposed in this paper has been conceived to perform an *in situ* calibration of sensor-based measuring units that monitor chemical pollutants in the atmosphere. The main peculiarity of the developed device is its remote programmability, which allows the whole calibration procedure to be exercised without intervention of technicians at the unit site, with the exception of the set-up of the calibration cell, which is the environment where the sensors under calibration are subjected to known gas concentrations. Single measuring units, as well as distributed measuring systems, can be calibrated by employing different traveling standards, which are managed by a central control unit.

A prototype of a traveling standard that is able to generate known concentrations of CO and NO<sub>2</sub> has been developed

according to the proposed architecture. A procedure has also been proposed for calibrating the reference gas sensors of the traveling standard, and preliminary tests have been performed, whose results have shown the effectiveness of the proposed calibration procedure. Further tests are required in order to estimate the long-term drift of the gas sensors so that a complete estimation of the expected uncertainty can be stated. Another aspect that has to be considered is the cross sensitivity of the employed sensors that will be investigated by performing specific experimental tests.

## REFERENCES

- [1] W. Tsujita, S. Kaneko, T. Ueda, H. Ishida, and T. Moriizumi, "Sensor-based air-pollution measurement system for environmental monitoring network," in *Proc. 12th Int. Conf. Solid-State Sens., Actuators Microsyst.*, Boston, MA, Jun. 2003, pp. 544–547.
- [2] S. Marra, F. C. Morabito, and M. Versaci, "Neural networks and Cao's method: A novel approach for air pollutants time series forecasting," in *Proc. Int. Joint Conf. Neural Netw.*, Jul. 2003, vol. 4, pp. 2448–2453.
- [3] A. Amato *et al.*, "Analysis and metrological characterization of the state of atmospheric pollution by means of mathematical models and agents," in *Proc. Int. Symp. Comput. Intell. Meas. Syst. Appl.*, Lugano, Switzerland, Jul. 2003, pp. 140–145.
- [4] P. Strobel, A. Lfakir, M. Siadat, and M. Lumberras, "A portable gas recognition system based on metal oxide gas sensor array," in *Proc. IEEE Sensors*, Oct. 2004, vol. 1, pp. 123–126.
- [5] M. Kuttila and J. Viitanen, "Sensor array for multiple emission gas measurements," in *Proc. IEEE Int. Symp. Circuits Syst.*, May 2005, vol. 2, pp. 1758–1761.
- [6] W. Tsujita, H. Ishida, and T. Moriizumi, "Dynamic gas sensor network for air pollution monitoring and its auto-calibration," in *Proc. IEEE Sensors*, Oct. 2004, pp. 56–59.
- [7] A. Boscolo and C. Mangiavacchi, "Pollution dynamic monitoring system for city air quality control," in *Proc. IEEE Instrum. Meas. Technol. Conf.*, St. Paul, MN, May 1998, vol. 1, pp. 202–205.
- [8] A. Carullo, "Metrological management of large-scale measuring systems," *IEEE Trans. Instrum. Meas.*, vol. 55, no. 2, pp. 471–476, Apr. 2006.
- [9] A. Carullo, M. Parvis, and A. Vallan, "A traveling standard for the calibration of data acquisition boards," *IEEE Trans. Instrum. Meas.*, vol. 53, no. 2, pp. 557–560, Apr. 2004.
- [10] *Measurement Management Systems—Requirements for Measurement Processes and Measuring Equipment*, 2003. ISO 10012:2003.
- [11] A. Carullo, S. Corbellini, and S. Grassini, "In-situ calibration of pollutant measuring-units by means of remotely-controlled traveling standards," in *Proc. IEEE Instrum. Meas. Technol. Conf.*, Sorrento, Italy, Apr. 2006, pp. 959–964.
- [12] *General Information for TGS Sensors*, Glenview, IL: Figaro. [Online]. Available: <http://www.figarosensor.com/gaslist.html>
- [13] *Guide to the Expression of Uncertainty in Measurement*, 1999. ENV 13005.



**Alessio Carullo** was born in Italy in 1966. He received the M.S. degree in electronic engineering from Politecnico di Torino, Torino, Italy, in 1992, and the Ph.D. degree in electronic instrumentation from the Università di Brescia, Brescia, Italy, in 1997.

Currently, he is an Assistant Professor with the Dipartimento di Elettronica, Politecnico di Torino, where he is responsible for the SIT Calibration Center. 139. He is involved with the development of intelligent instrumentation and the validation of

automatic calibration systems.



**Simone Corbellini** was born in Italy in 1977. He received the M.S. degree in electronic engineering and the Ph.D. degree in metrology from Politecnico di Torino, Torino, Italy, in 2002 and 2006, respectively.

His main fields of interest are digital signal processing, distributed measurement systems, and intelligent microcontroller-based instrumentation. Currently, he is working on the development of a measuring system for physical and chemical characterization of thin films.



**Sabrina Grassini** was born in Italy in 1972. She received the M.S. degree in chemistry from the Università di Torino, Torino, Italy, in 1999 and the Ph.D. degree in metallurgical engineering from Politecnico di Torino in 2004.

Currently, she is a Postdoctoral Researcher with the Dipartimento di Scienza dei Materiali e Ingegneria Chimica, Politecnico di Torino. Her research areas include plasma chemistry and coating deposition, corrosion and protection of metallic materials, and conservation of cultural heritage.