

A new implementation of a multiport automatic network analyzer

Original

A new implementation of a multiport automatic network analyzer / Ferrero, ANDREA PIERENRICO; U., Pisani; K. J., Kerwin. - In: IEEE TRANSACTIONS ON MICROWAVE THEORY AND TECHNIQUES. - ISSN 0018-9480. - 40:(1992), pp. 2078-2085.

Availability:

This version is available at: 11583/1400363 since:

Publisher:

IEEE

Published

DOI:

Terms of use:

This article is made available under terms and conditions as specified in the corresponding bibliographic description in the repository

Publisher copyright

(Article begins on next page)

A New Implementation of a Multiport Automatic Network Analyzer

Andrea Ferrero, *Member, IEEE*, Umberto Pisani, and Kevin J. Kerwin, *Member, IEEE*

Abstract—A generalized multiport network analyzer implemented using commercially available hardware is presented. Measurement calibration is accomplished through a novel calibration procedure which requires only conventional standards used for two-port calibrations. The calibration theory accounts for the errors due to the signal switching network but does not systematically remove errors due to signal leakage between port pairs. The approach is verified on a three-port test set implementation, and the measuring system can be expanded to n -ports with additional hardware in a straightforward manner. Experimental verification was carried out through measurement of one, two, and three ports devices connected to the test set ports in several different ways. Excellent agreement of the same corrected S -parameters measured at different test set ports was observed, and confidence in system accuracy is established through measurement of two-port verification standards.

I. INTRODUCTION

AS MICROWAVE integrated circuit technology advances, more complicated blocks which require multiport RF characterization are becoming common. Examples are balanced linear amplifiers, beam-forming networks for dual-circular polarization antennas and so on. A large amount of literature is available concerning error models, calibration procedures, and measurement of two-port devices, all differing in degree of complexity and effectiveness [1]–[7].

A generalization of network analyzer (NWA) calibration procedures to multiport measurements was proposed in a series of papers by R. A. Speciale and alii [8]–[10]. In these papers the technique of through-short-delay (TSD), developed for two-port measurements, was extended to an n -port by representing systematic errors through the S -parameter response of a $2n$ -port error network virtually connected between the device and an ideal error-free multiport NWA. In the more general case, which also accounted for the errors due to signal leakage among all port pairs of the error network, test set calibration was carried out by means of three n -port standards.

Because multiport network analyzers were not commercially available, an alternative approach based on a conventional two-port measurement system was proposed

[10] which required several partial two-port measurements with the n -port device connected in various two by two combinations. In each of these two-port measurements the $(n - 2)$ unused ports of the device must be terminated with perfectly matched loads; since this requirement cannot be met in practice with sufficient accuracy, mismatch errors are induced in the n -port device characterization.

An exact solution was proposed [10] in order to solve this practical problem, based upon a S -parameter normalization and renormalization by means of matrix transformations, to various sets of port impedances. This approach did not employ n -port standards for test set calibration but required a large number of different complete two-port measurements, so that it appears cumbersome.

In this paper realization of a multiport S -parameter test system with commercially available instrumentation and a far simpler calibration technique is demonstrated. A new analysis and mathematical reformulation of the calibration problem results in a simple repetitive procedure. According to this new algorithm, complete calibration of the n -port NWA requires measurement of three arbitrary one-port standards connected at one NWA port, and only $(n - 1)$ measurements of a known two-port standard, such as a "zero-length thru," connected in turn between the previously selected port and the other $(n - 1)$ ports. The need for multiport standards is eliminated and only $(n - 1) + 3$ standard connections are required to perform the entire calibration.

The signal flow error model on which the calibration theory and procedure is based is exact when it is assumed that no leakage exists between any port pairs of the error network virtually connected between the device and the ideal error-free multiport network analyzer [11]. This same premise is assumed in such well-known techniques as TRL [5] or LRM [6]. When applied to on-wafer MMIC measurements this assumption should not adversely affect experimental results except for very lossy devices.

II. REALIZATION OF A MULTIPORT NWA

The multiport test system was implemented to measure three-port devices. The system block diagram, shown in Fig. 1, consists of a vector network analyzer, a pair of four channel frequency converters, microwave switches and directional couplers.

Manuscript received October 8, 1991; revised April 1, 1992.

A. Ferrero and U. Pisani are with the Politecnico di Torino, Corso Duca degli Abruzzi 24, 10129 Torino, Italy.

K. J. Kerwin is with Hewlett-Packard Company, Microwave Technology Division, 1412 Fountain Grove Parkway, Santa Rosa, CA 95401.
IEEE Log Number 9202902.

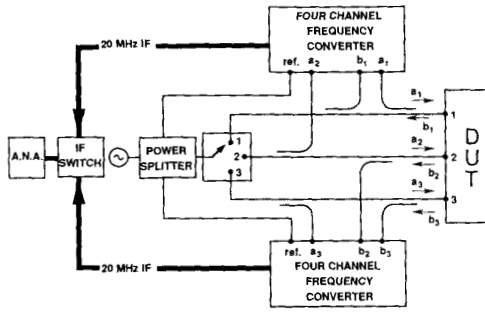

Fig. 1. Block diagram of a three-port S -parameter test set implemented using commercial instrumentation.

In order to allow ratioed measurements between voltage waves sampled by two different frequency converters, one channel in each frequency converter is used as a reference channel for NWA phase locking. An IF switch built into one of the two test sets connects the appropriate signal pairs to the NWA IF converter for the further down-conversion and digital signal processing.

By increasing the number of switches and four channel frequency converters this basic block diagram can be expanded to n -port measurements, where the number of test sets required is the ceiling of $2n/3$. Since the calibration algorithm can not be performed by standard instrument firmware, an external controller drives the NWA and test set and produces corrected measurements.

III. MULTIPOINT CALIBRATION TECHNIQUE

As shown in Fig. 2 a practical multipoint test set under the no-leakage hypothesis can be seen as a source, a switching network which drives each port i independently and n four-port networks providing two independent readings a_{mi} , b_{mi} . Each of these four-port networks is a generalized model of the NWA signal separation, down-conversion and digitizing process. The quantities a_{mi} and b_{mi} are the output readings of the NWA, and they are conventionally treated as voltage waves incoming and outgoing the error box. This notation is assumed in order to make use of the concepts of an idealized NWA [6].

Let the raw pseudo-scattering matrix S_m be defined by

$$\mathbf{b}_m = S_m \mathbf{a}_m \quad (1)$$

where \mathbf{a}_m and \mathbf{b}_m are the unratioed readings vectors:

$$\mathbf{a}_m = \begin{bmatrix} a_{m1} \\ a_{m2} \\ \vdots \\ a_{mn} \end{bmatrix} \quad (2)$$

$$\mathbf{b}_m = \begin{bmatrix} b_{m1} \\ b_{m2} \\ \vdots \\ b_{mn} \end{bmatrix} \quad (3)$$

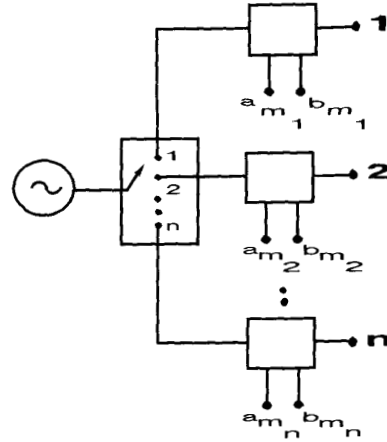

Fig. 2. Generalized model of a multipoint test set.

In order to measure the parameter S_{mik} between ports i and k , the source is applied to port k and the ratio b_{mi}/a_{mk} is acquired, while the other measurement ports should be ideally matched, so that the a_{mj} ($j \neq k$) readings should be zero. In practice imperfect terminations and switch repeatability in the four-port networks results in nonzero a_{mj} readings. In order to evaluate the corrected S_m matrix these readings must be acquired and their effects corrected in software.

With the source connected at port k , a_{mk} is the unique independent variable of the system. By measuring the $(n-1)$ ratios a_{mi}/a_{mk} the following set of n equations (one for each port) in n^2 unknowns S_{mij} is obtained:

$$\begin{aligned} \frac{b_{m1}}{a_{mk}} &= S_{m11} \frac{a_{m1}}{a_{mk}} + S_{m12} \frac{a_{m2}}{a_{mk}} \\ &+ \cdots + S_{m1k} + \cdots + S_{m1n} \frac{a_{mn}}{a_{mk}} \\ &\vdots \\ \frac{b_{mk}}{a_{mk}} &= S_{mk1} \frac{a_{m1}}{a_{mk}} + S_{mk2} \frac{a_{m2}}{a_{mk}} \\ &+ \cdots + S_{mkk} + \cdots + S_{mkn} \frac{a_{mn}}{a_{mk}} \\ &\vdots \\ \frac{b_{mn}}{a_{mk}} &= S_{mn1} \frac{a_{m1}}{a_{mk}} + S_{mn2} \frac{a_{m2}}{a_{mk}} \\ &+ \cdots + S_{mnk} + \cdots + S_{mnn} \frac{a_{mn}}{a_{mk}} \end{aligned} \quad (4)$$

By switching the source of each of the n positions in turn, a linear system of n^2 equations in n^2 unknowns can be formed by n equation sets like (4) and the S_{mij} parameters computed.

Now the relationship between the raw S_m and the S matrices of the device is considered. The set of n four-port networks depicted in Fig. 2 can be represented as n error

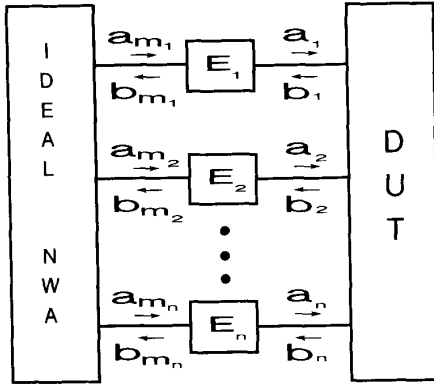

Fig. 3. Multiport virtual error network which interfaces the device to an ideal multiport network analyzer.

boxes interfacing an ideal NWA which measures S_m , with the DUT reference planes as shown in Fig. 3.

Each error box is defined by the following pseudo-scattering matrix E_i , where $i = 1, \dots, n$:

$$E_i = \begin{bmatrix} e_i^{00} & e_i^{01} \\ e_i^{10} & e_i^{11} \end{bmatrix} \quad (5)$$

The error box concept can be extended to a multiport measuring system, where the error coefficients become the elements of four diagonal matrices Γ_{ij} :

$$\Gamma_{11} = \begin{bmatrix} e_1^{11} & & & \\ & e_2^{11} & & \\ & & \ddots & \\ 0 & & & e_n^{11} \end{bmatrix} \quad \Gamma_{10} = \begin{bmatrix} e_1^{10} & & & \\ & e_2^{10} & & \\ & & \ddots & \\ 0 & & & e_n^{10} \end{bmatrix} \quad (6)$$

$$\Gamma_{00} = \begin{bmatrix} e_1^{00} & & & \\ & e_2^{00} & & \\ & & \ddots & \\ 0 & & & e_n^{00} \end{bmatrix} \quad \Gamma_{01} = \begin{bmatrix} e_1^{01} & & & \\ & e_2^{01} & & \\ & & \ddots & \\ 0 & & & e_n^{01} \end{bmatrix}$$

After some matrix manipulation, detailed in Appendix B, it results:

$$S_m = \Gamma_{00} + \Gamma_{01} [I - S\Gamma_{11}]^{-1} S\Gamma_{10} \quad (7)$$

where I is the n -dimensional unitary matrix and S is the scattering matrix of the multiport DUT. Equation (7) can be rewritten in the form:

$$\Gamma_{01}^{-1} (S_m - \Gamma_{00}) \Gamma_{10}^{-1} = (I - S\Gamma_{11})^{-1} S \quad (8)$$

Letting:

$$A = \Gamma_{01}^{-1} (S_m - \Gamma_{00}) \Gamma_{10}^{-1} \quad (9)$$

and rearranging (8) we obtain:

$$S = A(I + \Gamma_{11}A)^{-1} \quad (10)$$

Equations (9) and (10) allow simple and direct computation of the corrected scattering parameters S from S_m and are straightforward to implement using mathematically oriented programming languages.

Evaluation of the matrices A and Γ_{11} is considered in the next section.

IV. ERROR MATRIX COMPUTATION

Since the error matrices, Γ_{00} , Γ_{01} , and Γ_{10} are diagonal, matrix A becomes:

$$A = \begin{bmatrix} \frac{(S_{m11} - e_1^{00})}{t_{11}} & \frac{S_{m12}}{t_{12}} & \dots & \frac{S_{m1n}}{t_{1n}} \\ \frac{S_{m21}}{t_{21}} & \frac{(S_{m22} - e_2^{00})}{t_{22}} & \dots & \frac{S_{m2n}}{t_{2n}} \\ \vdots & \vdots & \ddots & \vdots \\ \frac{S_{mn1}}{t_{n1}} & \dots & \dots & \frac{(S_{mnn} - e_n^{00})}{t_{nn}} \end{bmatrix}$$

where

$$t_{ij} = e_i^{01} e_j^{10} \quad (11)$$

The error coefficients t_{ij} and e_i^{00} of the matrix A and the elements e_i^{11} (for $i, j = 1, \dots, n$) of the Γ_{11} matrix are derived by means of a calibration technique which follows a repetitive experimental procedure based on the extension of the QSOLT calibration technique [12], [13].

Since this procedure requires the insertion of a known two-port standard, an ideal "zero-length" thru connection is first assumed and the theory will be developed using this component since the mathematics involved is simpler. The correction for the arbitrary two-port standard is presented in Appendix A.

The calibration steps are as follows:

1. At port 1 a usual one-port calibration is performed using three known standards; acquire the corresponding values of $(b_{m1}/a_{m1})^\dagger$ and compute the three error coefficients e_1^{00} , e_1^{11} , and t_{11} .
2. A repetitive procedure is then carried out for the other $(n - 1)$ ports. At port k ($k = 2, \dots, n$), the four elements of the S_m matrix obtained from measurements of the ideal thru connected between port 1 and port k provide:

$$\begin{cases} S_{m1k}^{T1k} = e_1^{00} + \frac{t_{11} e_k^{11}}{1 - e_1^{11} e_k^{11}} \\ S_{mk1}^{T1k} = \frac{t_{k1}}{1 - e_1^{11} e_k^{11}} \\ S_{m1k}^{T1k} = \frac{t_{1k}}{1 - e_1^{11} e_k^{11}} \\ S_{mkk}^{T1k} = e_k^{00} + \frac{t_{kk} e_1^{11}}{1 - e_1^{11} e_k^{11}} \end{cases} \quad (12)$$

[†]Since only one port is involved, all the a_{mj} ($j \neq 1$) are zero so that $S_{m11} = b_{m1}/a_{m1}$ and the procedure to obtain S_m is needless.

Noting that:

$$t_{kk} = e_k^{01} e_k^{10} = \frac{t_{k1} t_{1k}}{t_{11}}, \quad (13)$$

this system of equations in the unknowns e_k^{00} , e_k^{11} , t_{k1} , t_{1k} , and t_{kk} can be solved to obtain:

$$e_k^{11} = \frac{S_{m11}^{T1k} - e_1^{00}}{t_{11} + e_1^{11}(S_{m11}^{T1k} - e_1^{00})} \quad (14)$$

$$t_{k1} = S_{mk1}^{T1k} (1 - e_1^{11} e_k^{11}) \quad (15)$$

$$t_{1k} = S_{m1k}^{T1k} (1 - e_1^{11} e_k^{11}) \quad (16)$$

$$t_{kk} = S_{mk1}^{T1k} S_{m1k}^{T1k} (1 - e_1^{11} e_k^{11})^2 / t_{11} \quad (17)$$

and

$$e_k^{00} = S_{mkk}^{T1k} - \frac{t_{kk} e_1^{11}}{1 - e_1^{11} e_k^{11}} \quad (18)$$

- In case of a two-port NWA the previous formulas completely solve the calibration problem; for more than two ports the other remaining unknowns are t_{kj} and t_{jk} of the transmission path between port k and port j ($j = 2, \dots, k - 1$) with $k > 2$.

These terms can be easily obtained noting that:

$$t_{kj} = \frac{t_{k1} t_{1j}}{t_{11}}. \quad (19)$$

- Repeating steps 2 and 3 until $k = n$ completely determines the error coefficients of A and Γ_{11} .

The number of the thru connections required is the minimum necessary to uniquely determine all the error coefficients. For an n -port network analyzer we have $(4n - 1)$ unknowns which is equal to the number of independent measurements provided by this technique: $(4(n - 1) + 3)$. For a five-port NWA, seven connections of standards are required which is coincidentally the same number required to perform a standard SOLT calibration in a two-port system.

The method used for calculating the error elements of the matrices A and Γ_{11} can be made more general and less sensitive to imperfectly defined standards than the one suggested here. Any well-known self calibration procedure such as TRL [5] or LRM [6] can be applied to determine the error coefficients for two of the n ports. The remaining error coefficients for all the other $(n - 2)$ ports can be obtained by connecting only the thru line between one of the calibrated ports and each of the other $(n - 2)$ ports in turn following the previously suggested algorithm. Furthermore any two by two combination of the n ports instead of the here suggested one (i.e., port 1 with all the other ones) can be used given that one has been previously calibrated.

V. EXPERIMENTAL RESULTS

To verify the calibration technique and show consistent results, measurements were performed on one-, two-, and

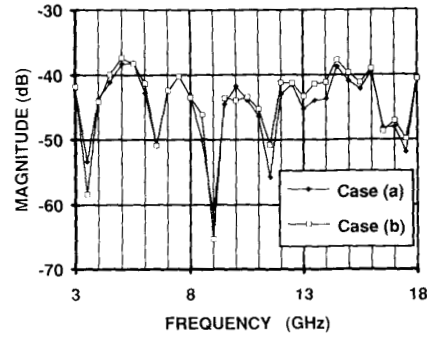
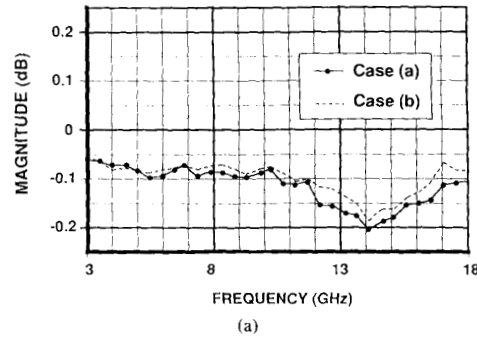
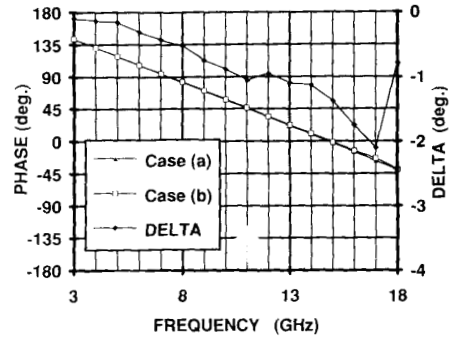

Fig. 4. Magnitude of a standard matched load reflection coefficient measured at: port 2 [case (a)] port 3 [case (b)].



(a)



(b)

Fig. 5. Standard coaxial short circuit reflection coefficient measured at port 2 [case (a)] and port 3 [case (b)]. Since the phase plots are quite similar, their difference DELTA is also plotted in figure 5(b).

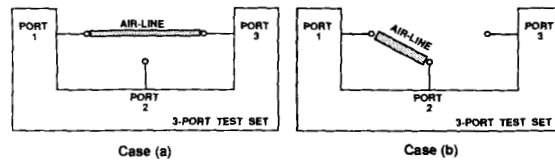

Fig. 6. Connection of the 15 cm air-line used with the 3-port system.

three-port passive components using the system described in Fig. 1. A 3 to 18 GHz calibration was performed: at port 1 a coaxial 3.5 mm sliding load and two offset short standards were connected, next port 1 was in turn connected with port 2 and port 3 (i.e., zero length thru).

An external controller was used to control the NWA,

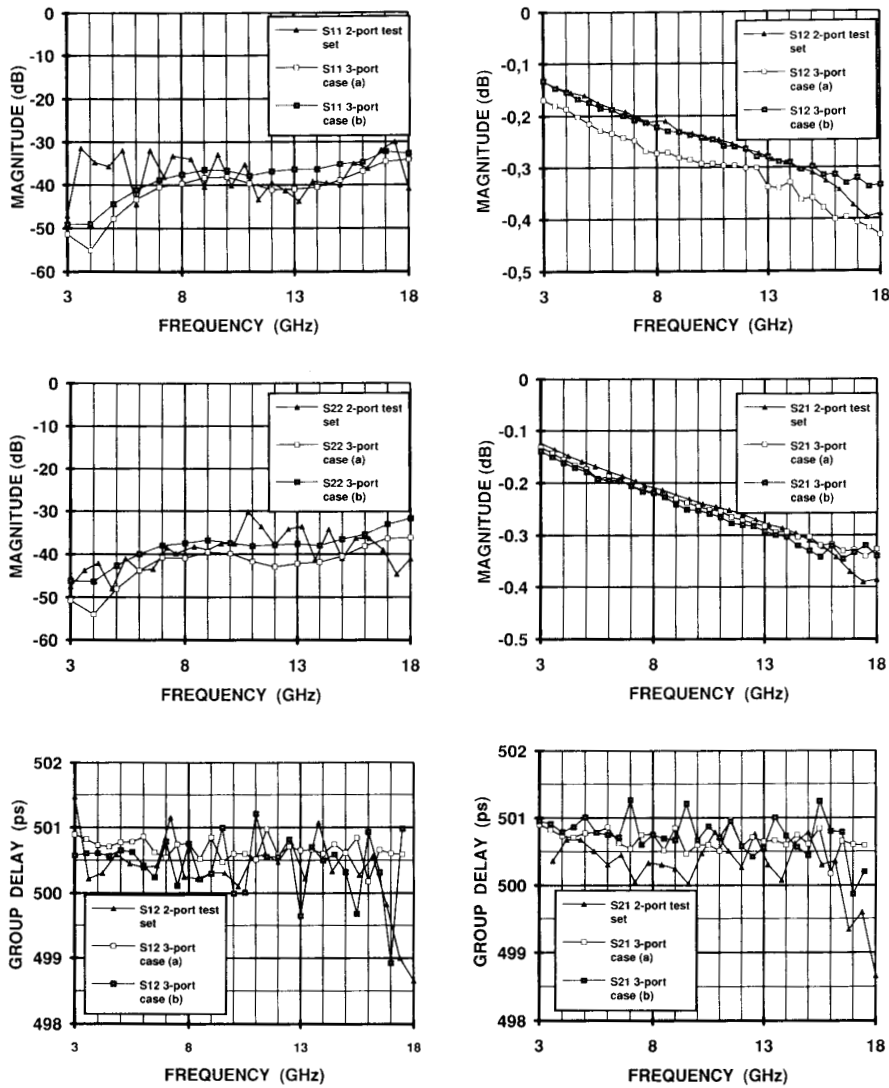

Fig. 7. Air-line S -parameters. The group delays of the transmission parameters are plotted so as to highlight the phase spreadings.

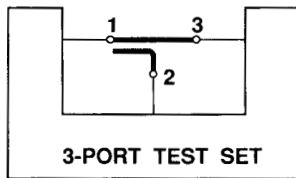

Fig. 8. Port connections used for directional coupler measurements.

absorb the raw data from the NWA, calculate the error coefficients, and display corrected S -parameters.

The first test device was a broadband 50Ω load. S -parameters were measured on ports 2 and 3 respectively while the unused ports were left open. This measurement could not have been performed at port 1 since the port

connector gender was the same as that of the test device. The results reported in Fig. 4 demonstrate that the NWA test ports are able to measure well matched loads (-40 dB) with good agreement and presents low residual directivity errors contribution at these ports.

A similar test was performed using a coaxial short standard at ports 2 and 3. The resulting data, shown in Fig. 5, are in close agreement and low residual source match seems to affect the results.

Next a 15 cm air-line of 500 ps nominal delay was connected, as shown in Fig. 6, between ports 1 and 2 and ports 1 and 3 respectively. The whole S -parameters were measured in the two cases of Fig. 6 and with an ordinary two-port NWA. The results, reported in Fig. 7, are satisfactory and show good agreement of all the different

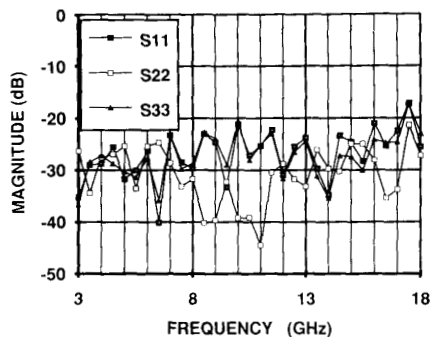

Fig. 9. Directional coupler S_{ii} parameters magnitude.

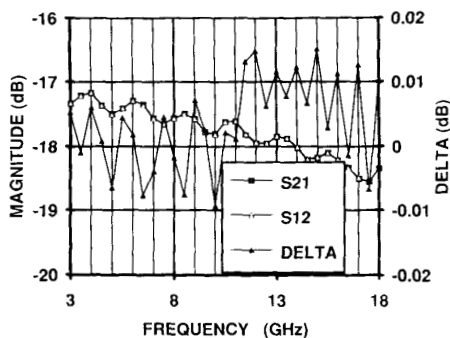

Fig. 10. Directional coupler S_{12} and S_{21} magnitudes and their difference DELTA.

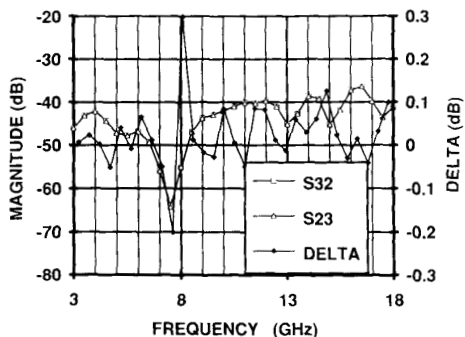
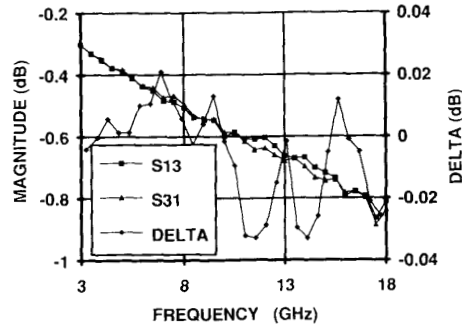

Fig. 11. Directional coupler S_{32} and S_{23} magnitudes and their difference DELTA.

tests. The 3-port NWA shows a precision comparable with the two port one regardless the higher test set complexity.

Finally the full 3-port S -parameter matrix of a directional coupler connected as shown in Fig. 8 was measured. In Fig. 9 the magnitude of the S_{ii} parameters is presented while the more significant transmission parameters S_{ij} and S_{ji} were compared with each other in Fig. 10, Fig. 11, and Fig. 12.

Unfortunately the multiport accuracy determination can only be accomplished when multiport verification standards become available. Presently only the reciprocity property of a passive three-port test device can be verified as a measure of the overall system accuracy.



(a)

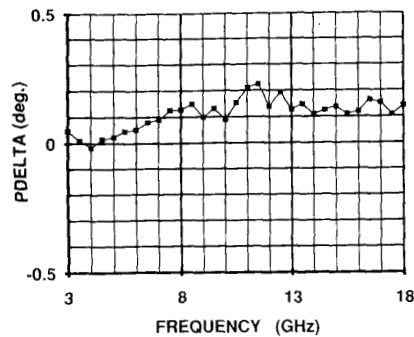

(b)

Fig. 12. Directional coupler S_{31} and S_{13} parameters: (a) Magnitudes and their difference DELTA (b) Phase difference PDELTA.

VI. CONCLUSION

A generalized multiport network analyzer has been presented based on commercial instrumentation and it can be calibrated using the same components used for two-port S -parameter calibration. The system architecture and calibration procedure are suitable for expansion of the number of test ports. The calibration theory accounts for errors due to switching network repeatability; the errors due to possible signal leakage between all port pairs are not included but are negligible for all but very lossy devices.

A three-port test set was built and several experiments were carried out in order to verify its performance. The quality of the resulting data approaches those obtained using commercial two-port S -parameter test sets. The test set is well-suited to measurement of two-port devices having either the same or different gender connectors without recalibrating the test set or using cumbersome adapter removal procedures.

APPENDIX A ARBITRARY THRU STANDARD

If a known but non-ideal "zero-length thru" two-port network is connected between ports 1 and k , the system of equations (12) in the second step of the above suggested algorithm is no longer valid. To compute the error coefficients a more useful notation based on the transmission matrix of each error box will be used.

Let

$$X_1 = \begin{bmatrix} -\frac{\Delta}{t_{11}} & \frac{e_1^{00}}{t_{11}} \\ -\frac{e_1^{11}}{t_{11}} & \frac{1}{t_{11}} \end{bmatrix} \quad (20)$$

and

$$X_k = \begin{bmatrix} \frac{e_k^{00}}{t_{1k}} & -\frac{e_k^{00}}{t_{1k}} \\ \frac{1}{t_{1k}} & -\frac{\Delta_k}{t_{1k}} \end{bmatrix} \quad (21)$$

which link the measured and actual quantities at each error box by means of the following relationships:

$$\begin{bmatrix} b_{m1} \\ a_{m1} \end{bmatrix} = e_1^{01} X_1 \begin{bmatrix} b_1 \\ a_1 \end{bmatrix} \quad (22)$$

and

$$\begin{bmatrix} a_{mk} \\ b_{mk} \end{bmatrix} = e_1^{01} X_k \begin{bmatrix} a_k \\ b_k \end{bmatrix} \quad (23)$$

From (22) and (23) it is straightforward to obtain:

$$T_{mk} = X_1 T_{st} X_k^{-1} \quad (24)$$

where T_{mk} is the transmission matrix obtained from the four related elements of S_m as

$$T_{mk} = \begin{bmatrix} -\det S_m^{T1k} & S_m^{T1k} \\ \frac{S_m^{T1k}}{S_m^{mk1}} & \frac{S_m^{T1k}}{S_m^{mk1}} \\ -\frac{S_m^{T1k}}{S_m^{mkk}} & \frac{1}{S_m^{mk1}} \\ \frac{S_m^{T1k}}{S_m^{mk1}} & \frac{S_m^{T1k}}{S_m^{mk1}} \end{bmatrix} \quad (25)$$

while T_{st} is the known two port standard transmission matrix.

From equation (24) it follows that:

$$X_k = T_{mk}^{-1} X_1 T_{st} \quad (26)$$

eventually

$$\left\{ \begin{array}{l} e_k^{00} = \frac{X_k^{21}}{X_k^{11}} \\ e_k^{11} = -\frac{X_k^{12}}{X_k^{11}} \\ t_{kk} = \frac{\det X_k}{(X_k^{11})^2} \\ t_{1k} = \frac{1}{X_k^{11}} \\ t_{k1} = t_{11} \frac{\det X_k}{X_k^{11}} \end{array} \right. \quad (27)$$

and the repetitive procedure can be resumed from step 3.

APPENDIX B

ERROR BOX CONCEPT EXTENSION TO A MULTIPOINT

For each error box E_i we have two equations which relate the normalized voltage waves at the ideal test set, labeled with a_{mi} , b_{mi} , and at the actual port, labeled as usual a_i , b_i :

$$b_{mi} = e_i^{00} a_{mi} + e_i^{01} b_i \quad (28)$$

$$a_i = e_i^{10} a_{mi} + e_i^{11} b_i \quad (29)$$

Extending these equations to n ports, we have:

$$\begin{aligned} a_1 &= e_1^{11} b_1 + e_1^{10} a_{m1} \\ a_2 &= e_2^{11} b_2 + e_2^{10} a_{m2} \\ &\vdots \end{aligned} \quad (30)$$

$$a_n = e_n^{11} b_n + e_n^{10} a_{mn}$$

$$b_{m1} = e_1^{01} b_1 + e_1^{00} a_{m1}$$

$$b_{m2} = e_2^{01} b_2 + e_2^{00} a_{m2}$$

$$\vdots \quad (31)$$

$$b_{mn} = e_n^{01} b_n + e_n^{00} a_{mn}$$

Introducing the matrices Γ_{ij} and the vectors \mathbf{a} , \mathbf{b} , \mathbf{a}_m and \mathbf{b}_m we have:

$$\mathbf{a} = \Gamma_{11} \mathbf{b} + \Gamma_{10} \mathbf{a}_m \quad (32)$$

and

$$\mathbf{b}_m = \Gamma_{01} \mathbf{b} + \Gamma_{00} \mathbf{a}_m \quad (33)$$

From the S matrix definition and (32) it is obtained:

$$\mathbf{b} = S \Gamma_{11} \mathbf{b} + S \Gamma_{10} \mathbf{a}_m \quad (34)$$

then:

$$\mathbf{b} = [\mathbf{I} - S \Gamma_{11}]^{-1} S \Gamma_{10} \mathbf{a}_m \quad (35)$$

Substituting (35) into (33) we eventually obtain:

$$\mathbf{b}_m = [\Gamma_{00} + \Gamma_{01} (\mathbf{I} - S \Gamma_{11})^{-1} S \Gamma_{10}] \mathbf{a}_m \quad (36)$$

REFERENCES

- [1] W. Kruppa and K. F. Sodomski, "An explicit solution for the scattering parameters of a linear two-port measured with an imperfect test set," *IEEE Trans. Microwave Theory Tech.*, vol. MTT-19, pp. 122-123, Jan. 1971.
- [2] S. Rhenmark, "On the calibration process of automatic network analyzer systems," *IEEE Trans. Microwave Theory Tech.*, vol. MTT-22, pp. 457-458, Apr. 1974.
- [3] G. F. Engen, "Calibration technique for automated network analyzers with application to adapter evaluation," *IEEE Trans. Microwave Theory Tech.*, vol. MTT-22, 1255-1260, Dec. 1974.
- [4] V. G. Gelnovatch, "A computer program for the direct calibration of two-port reflectometers for automated microwave measurements," *IEEE Trans. Microwave Theory Tech.*, vol. MTT-24, pp. 45-47, Jan. 1976.
- [5] G. F. Engen and C. A. Hoer, "Thru-reflect-line: An improved technique for calibrating the dual six-port automatic network analyzer," *IEEE Trans. Microwave Theory Tech.*, vol. MTT-27, no. 12, pp. 987-993, Dec. 1979.

- [6] H. J. Eul and B. Schiek, "A generalized theory and new calibration procedures for network analyzer self-calibration," *IEEE Trans. Microwave Theory Tech.*, vol. 39, no. 4, pp.724-731, Apr. 1991.
- [7] R. A. Soares *et al.*, "A unified mathematical approach to two-port calibration techniques and some applications," *IEEE Trans. Microwave Theory Tech.*, vol. 37, no. 11, pp. 1669-1673, Nov. 1989.
- [8] R. A. Speciale, "A generalization of the TSD network-analyzer calibration procedure, covering n-port scattering-parameter measurements, affected by leakage errors," *IEEE Trans. Microwave Theory Tech.*, vol. MTT-25, no. 12, pp. 1100-1115, ec. 1977.
- [9] R. A. Speciale, "Multiport network analyzers: Meeting the design need," *MSN*, pp. 67-89, June 1980.
- [10] J. C. Tippet and R. A. Speciale, "A rigorous technique for measuring the scattering matrix of a multiport device with a 2-port network analyzer," *IEEE Trans. Microwave Theory Tech.*, vol. MTT-30, no. 5, pp. 661-665, May 1982.
- [11] G. V. Butler *et al.*, "16-therm error model and calibration procedure for on wafer network analysis measurements," in *1991 IEEE MTT-S Int. Microwave Symp. Dig.*, May 1991, pp. 1125-1127.
- [12] A. Ferrero and U. Pisani, "QSOLT: a new fast calibration algorithm for two port S-parameter measurements," in *38th ARFTG Conf. Dig.*, San Diego, Dec. 5-6, 1991.
- [13] H. J. Eul and B. Schiek, "Reducing the number of calibration standards for network analyzer calibration," *IEEE Trans. Instrum. Meas.*, vol. 40, no. 4, pp. 732-735, Aug. 1991.
- [14] R. A. Speciale and N. R. Franzen, "Super-TSD: A generalization of the TSD network analyzer calibration procedure, covering n-port measurements with leakage," in *1977 IEEE G-MTT Int. Symp. Dig.*, San Diego, June 21-23, 1977, pp. 114-117.

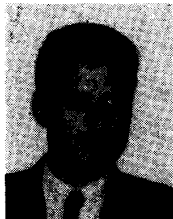

Andrea Ferrero (S'86-M'88) born in Novara, Italy, in 1962, received the electronic engineering degree in December 1987 at the Politecnico di Torino.

In 1988 he joined the Aeritalia company as microwave consultant. From 1988 to 1991 he attended the Electronic Ph.D. course at the Politecnico di Torino. During the summer of 1991 he joined the Hewlett Packard company at the Microwave Technology division in Santa Rosa as summer student. Since 1992 he is a Researcher at

the Politecnico di Torino. His current research activities are in the area of microwave measurement techniques and modeling.



Umberto Pisani received the Dr.Ing. degree in electronic engineering from Politecnico di Torino in 1967.

In 1968 he joined, as an Assistant Professor, the Dipartimento di Elettronica del Politecnico di Torino. In 1982 he became Associate Professor and in 1989 Full Professor in Electronics. He has conducted research in the area of active and passive device characterization and modeling, mainly in the microwave frequency region. In this field he contributed in the development of experimental techniques, concerning both bipolar transistors and MESFETs, in linear and large-signal behaviour, in design of solid state broad band amplifiers and power stages for satellite applications. Dr. Pisani presently is interested in MMIC devices. He is a member of AEI.



Kevin J. Kerwin (M'79) received the B.S. degree in mathematics from the University of Kentucky in 1975, the B.S.E.E. from the University of Texas in 1978, and did graduate work at Stanford University.

In 1979 he joined Hewlett-Packard Company in Santa Rosa, CA. From 1979 to 1980 he developed YIG and SAW device measurements and applications and from 1980 to 1983 power GaAs MESFETs and their measurements and applications at the Santa Rosa Technology Center. From 1983 to

1985 he worked on marketing and applications of the HP 8510 network analyzer to semiconductor and millimeter wave measurements at Network Measurements Division. From 1985 to 1989 he managed test and product engineering for GaAs FETs, silicon bipolar transistors, magnetic and acoustic devices, and GaAs ICs at Microwave Technology Division. Since 1989 he has been GaAs IC test systems manager where his responsibilities include test system software, measurement techniques, hardware, and software, and development of test solutions for GaAs ICs.