

Bernard Rudofsky. A Humane Designer

Original

Bernard Rudofsky. A Humane Designer / Bocco, Andrea. - STAMPA. - (2003), pp. 1-320.

Availability:

This version is available at: 11583/1392972 since: 2021-02-19T10:12:09Z

Publisher:

Springer Verlag

Published

DOI:

Terms of use:

This article is made available under terms and conditions as specified in the corresponding bibliographic description in the repository

Publisher copyright

(Article begins on next page)



Scherb. Interior designed by Josef Frank for House no. 12 in the Viennese Werkbund-siedlung, ca. 1932.

While the architectural concept of Frank's "settlement houses" met with the approval of the modernists, the interiors he designed for them were criticized as being too "feminine" or "bourgeois."

For Rudofsky, the choice of purist and minimalist forms is consistent with the decision not to pursue compositional originality and with the limitations he himself places on the volume of his own voice. He introduces the building into its environment "anonymously," shaping it in such a way as not to create a visual distraction for the inhabitants, who can thus devote their energies to the intensity of existence and to the liberation of the mind. Individual expression in the house is provided by the way of living inside, and not by formal exhibitionism outside. In Wright's houses, the abandonment of the representative forms of the dwelling of the European upper class (the grandiose principal door, the entryway, the axial sequence of rooms, the monumental furnishings, the facade) is consistent with the primary emphasis on comfort, the "supreme principle," and on the fundamental functions of daily life, which thus take on "an essential significance and dignity."¹⁴ (Despite the coherence of such an approach with his principles, Rudofsky never missed an opportunity to criticize Wright, in my opinion for two reasons. The first was an instinctive stylistic antipathy; Rudofsky had grown up in

¹⁴ Christian Norberg-Schulz, "La casa e il movimento moderno", *Lotus International*, n° 9, 1975, p. 32.

Frank Lloyd Wright. Perspectival view of Victor Metzger villa (Sault St. Marie, Michigan), 1910.

In the years between 1890 and 1910, the evolution of Wright's designs for "prairie houses" led to a progressive abandonment of the forms representative of upper-class housing.

The publication of the Wasmuth edition of his works, especially the residential ones, had a notable influence on European architecture.



G. E. Kidder Smith. Frontini House, corner of study (below, left) and master bedroom (above, right), 1942.

A photo such as this one betrays an estheticizing intention that tends to isolate the building from its context (and its parts from the whole). It was taken by a professional architectural photographer in the absence of any instructions from Rudofsky, who nonetheless published it. What is more, he himself frequently cropped and retouched photographs of his works, so as to enhance their visual appeal.

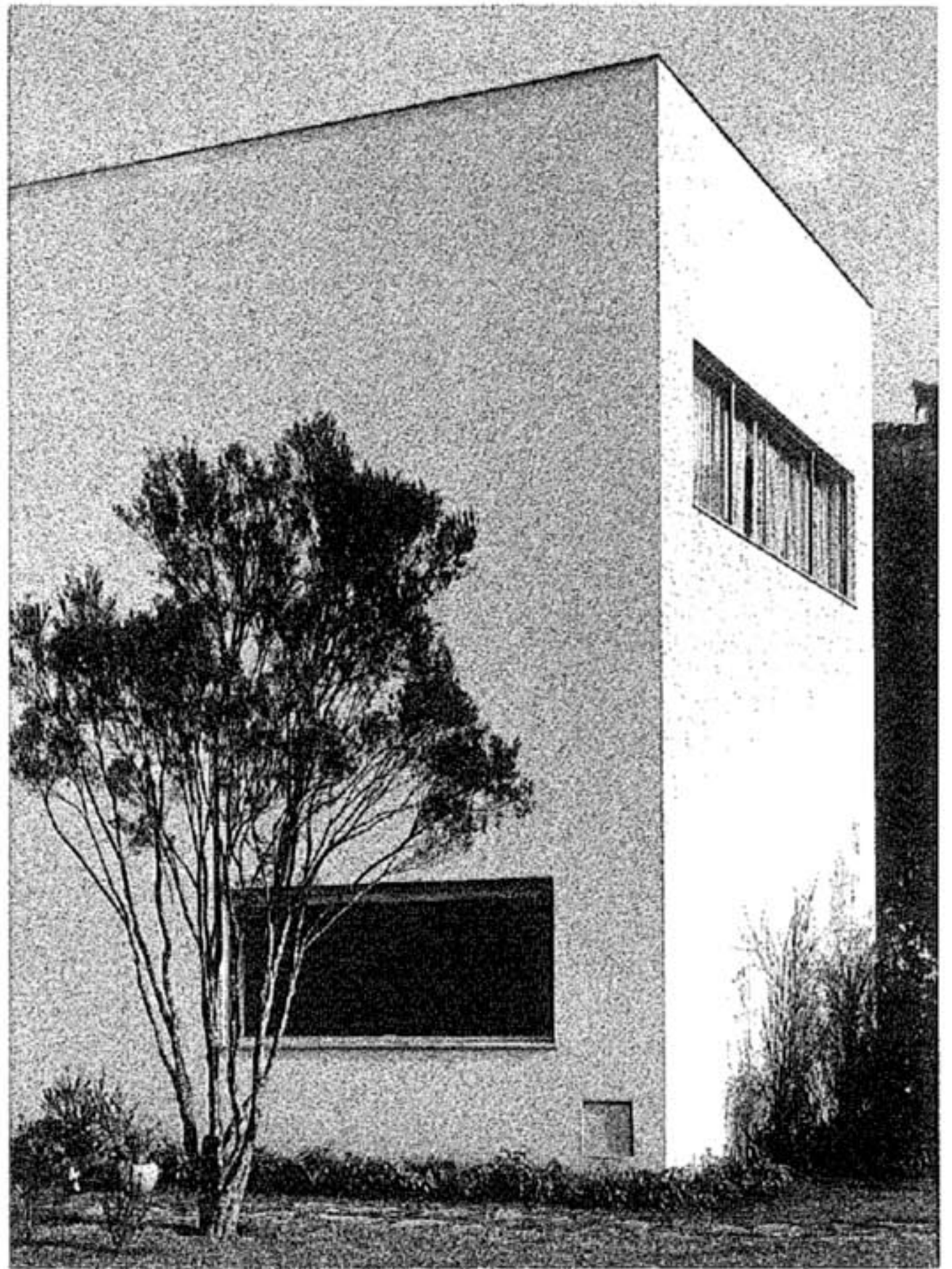

See *Invitation to Japan*, p. 209 ff.

an entirely different cultural milieu. The second was of a theoretical nature: like Loos, Rudofsky could not tolerate an architect's imposing his own formal choices on the inhabitants — and in Wright's case, these choices involved even the most minute particulars.)

Rudofsky admired the traditional Japanese house because "'Nothing too much' is in it. Protest against ostentation. Serenity, introspection. Modesty, formality, nobility, and reserve. It is opposed to everything that is garish, and loud."¹⁵ "The oriental house at its best...is all house, all shelter, a true sanctuary for man."¹⁶

Rudofsky's words on the Japanese house may serve to describe his own work. If external appearance and ornament have, in architecture as in dress, a social function above all, then there is even more significance in Rudofsky's decision to separate domestic from public architecture — to render his houses introverted, antisocial, and thus not to worry about their symbolic representation towards the outside world. (Nonetheless, the photos he takes or selects for publication betray a desire and capacity for self-representation.)

¹⁵ Bernard Rudofsky, unpublished lecture on Japan.

¹⁶ Bernard Rudofsky, unpublished lecture with slides on Japan, perhaps held in Japan (?), 1960.

The impossibility of faking a primordial innocence in a modern design does not prevent him from borrowing from "minor" Mediterranean architecture and from the frugal way of life of its inhabitants a certain restraint and dignity — even a skillfully controlled naïveté. The minimalist vocabulary of wide openings and simple, smooth, flat, orthogonal volumes absorbs the simplicity of a vernacular born of necessity, transforming it into refinement. The study of rural architecture leads him both to formulate principles of design and to sublimate formal and constructional elements. Gio Ponti recognizes this clearly and sums it up neatly: "The Mediterranean taught Rudofsky, Rudofsky taught me."¹⁷

Despite his vast written output, Rudofsky provides no stylistic or compositional instructions for creating architecture. Nor does he show any particular interest in formal experimentation in his own works. A humanist architect, he cares about the way of inhabiting or, to put it more broadly, the quality of life (something that has nothing to do with luxury, and even less with consumerism). Like Taut faced with the traditional Japanese house, he maintains that "[t]he most interesting feature of the house is not its material appearance but its life."¹⁸

The stylistic question is relegated to the background by his basic premise: "What's needed is not a new way of building, what's needed is a new way of life."¹⁹ This was Rudofsky's lifelong motto: it appears for the first time in 1938 as the title of his comment on the house on the island of Procida, and becomes the subtitle of *Sparta/Sybaris* in 1987.²⁰

see Repertory of Compositional Elements, p. 46 ff.

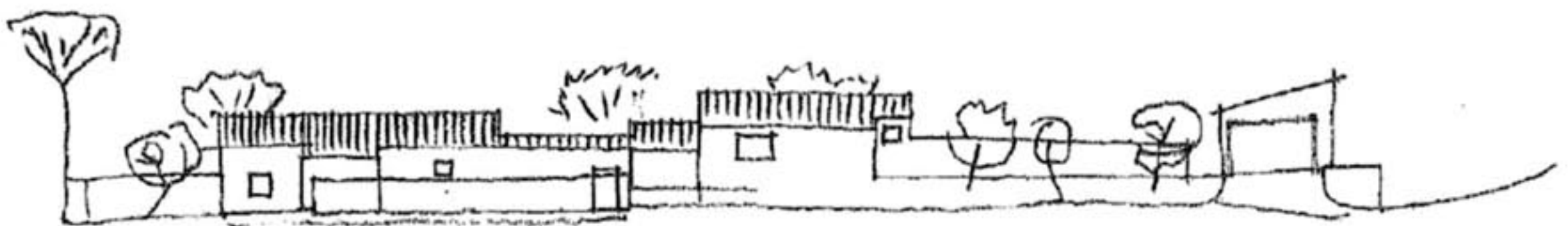

Modernist architectural language can thus be seen as an expressive code taken on board from the start and used to express personal contents. It should be noted, however, that this language is entirely consistent with Rudofsky's radical and purist tastes. His assertion that "complexity has never been a virtue"²¹ is worthy of Loos at his best, just as his saying, "remember, art means to omit" echoes Frobenius's "Art calls for simplification."²² It is not at all surprising that Rudofsky appreciated the austerity of traditional Japanese buildings, "supreme stud[ies] in elimination."²³

Such rarefaction should perhaps also be understood as an ingenuous, typically modernist attempt to deny any involvement with the historical connotations of shapes, so as to approach as nearly as possible to the eternal character of pure geometric solids and "anonymous" peasant houses.

Bernard Rudofsky. Preliminary sketch of La Casa's west elevation, 1969. It would be hard to tell—given the drawing's degree of definition—whether this is a representation of an existing traditional house or a design for a new building.

17 AR54.1, p. 23–36.

18 Bruno Taut, *Houses and People of Japan*, Tokyo: Sanseido, 1958², p. 190–191.

19 See also BR38.10.

20 See BR38.9 (here at page 175), S/S.

21 BPW, p. 7.

22 Leo Frobenius, *Das unbekante Afrika*, München: C.H. Beck, 1923.

23 Frank Lloyd Wright (edited by Edgar Kaufmann), *An American Architecture*, New York: Horizon Press, 1955, p. 246.

Repertory of Compositional Elements

Elementary volumes

The building is often an aggregation of geometrical volumes, adhering to one another in groups which can be highly articulated as a result of the contours of the ground, or clustered "village-like." The masonry "boxes" containing windows, the chimneys, etc. likewise constitute distinct volumes, added to the exterior of the larger volumes, as in some "spontaneous" architecture.

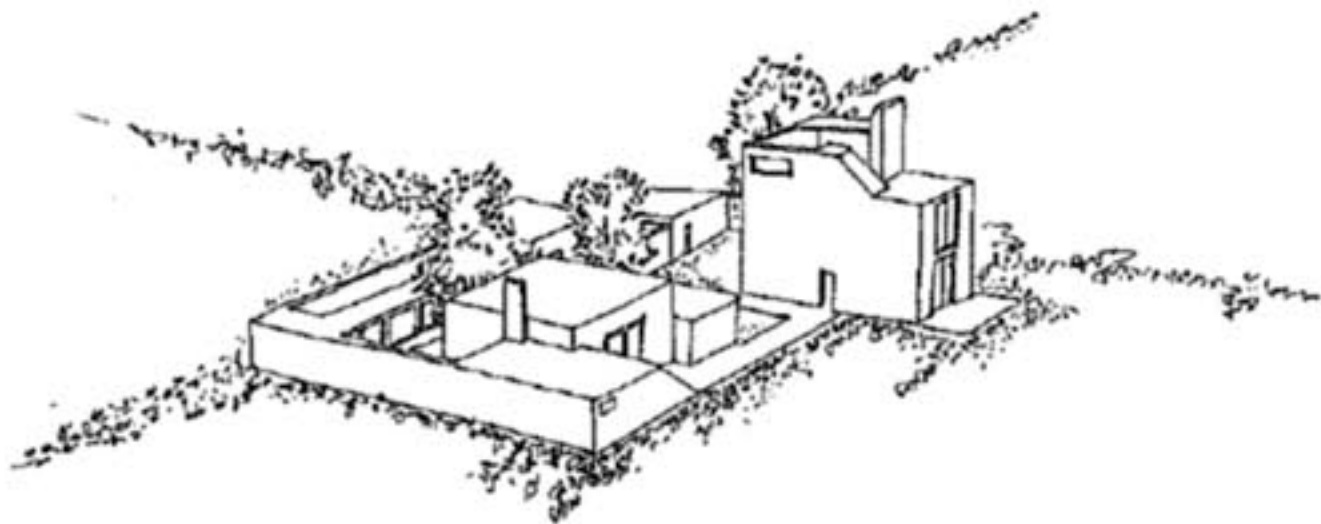

Marsicano house

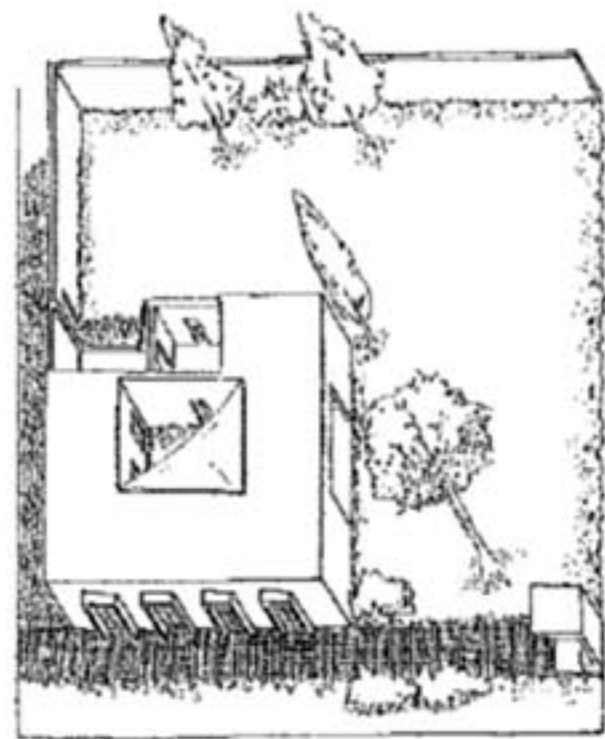

Procida house

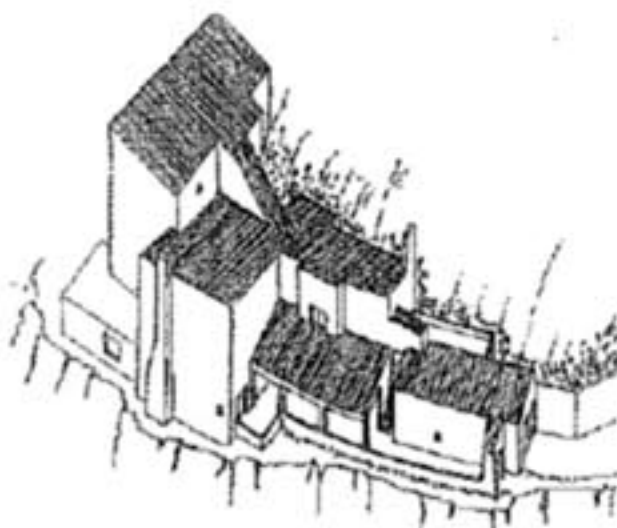

villa D

A single-story house

Rudofsky states: "[T]he majority of good modern houses are one-storied. Where this simple and excellent arrangement is abandoned, and a house is built on the top of a house, the result is undignified. The staircase, generally regarded as an added inconvenience, is truly an egregious insult."²⁴ In reality, not all Rudofsky's houses are one-storied; but among these can be found some of his most convincing plans.

Roofs

Rudofsky designs volumes with flat roofs, but also with tiled coverings having a single or double pitch. Sometimes these different solutions are adopted in a single building, thus enhancing the play of volumes. The pitched roofs have a single slope throughout the house: this practice, drawn from rural architecture, can entail the erection of quite tall volumes.

Since false ceilings are not employed, in an interior covered by a pitched roof there is a clear perception of "which way the room is facing" and of the direction to which it "turns its back."

Voids

Rudofsky assigns a value to volumes lacking one or more walls [see p. 61]. In the Villa Campanella, this procedure of subtraction is carried so far that it is impossible to say whether the open volumes have been hollowed out from the walled box or whether, instead, the rooms are not empty spaces, the perception of whose definition is assisted by built-up walls.

In addition, the use of loggias (free-standing or backed up against the walls of a building) and verandas is very frequent.

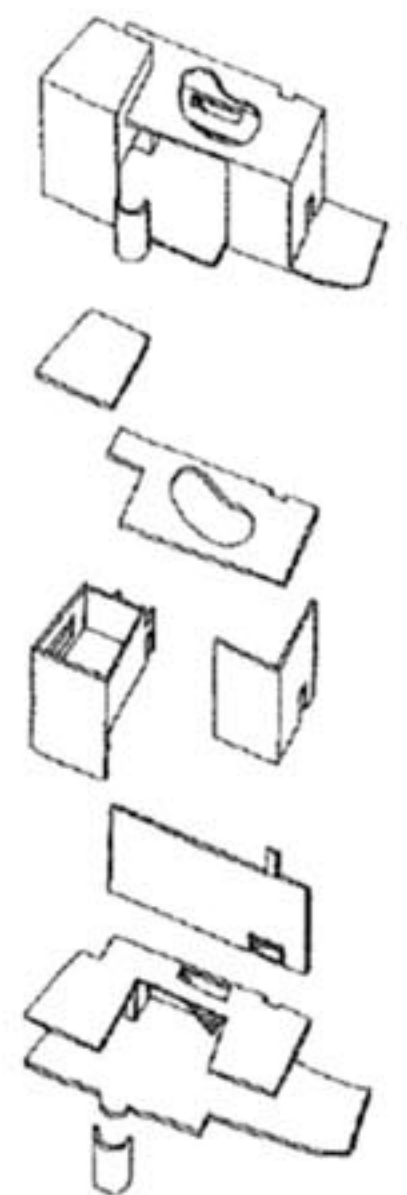

villa Campanella

The drawings on these pages show formal and constructional elements that contribute to the definition of a Rudofskian "pattern language."

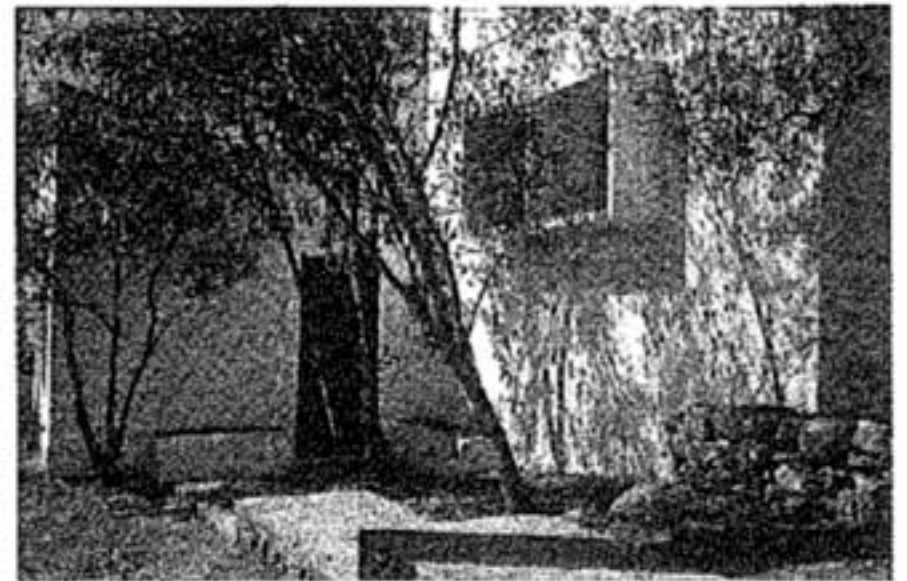

Bernard Rudofsky. *La Casa*, corner of studio (left) and bedroom with protruding masonry box containing the window, 1982.

Both rooms turn their tallest wall to the east and the single pitch of their roof to the west. The repetition of a minimal lexicon of building elements makes this house look as if it were the result of a spontaneous growth of building units.

²⁴ Bernard Rudofsky, unidentified undated manuscript on gardens and housewives, p. 1.

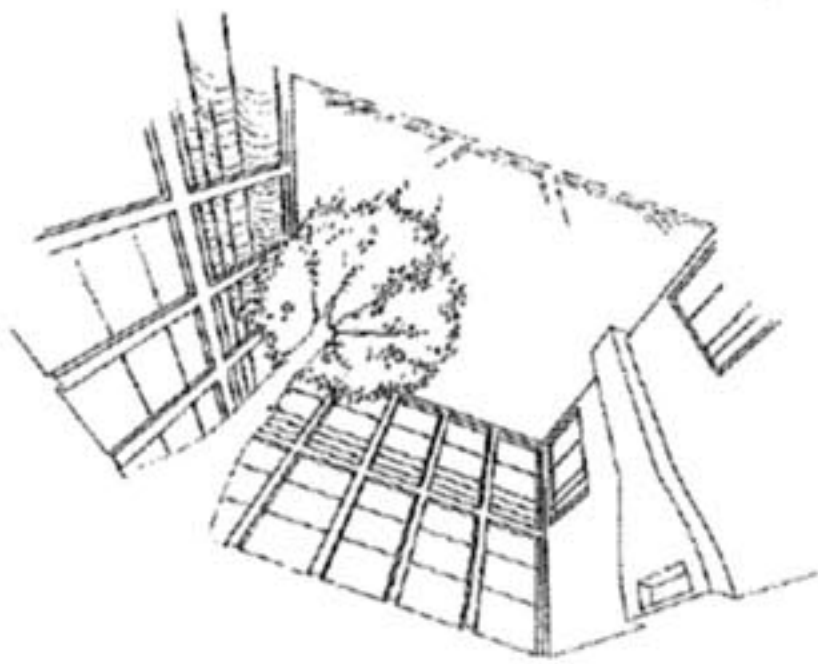

Frontini house

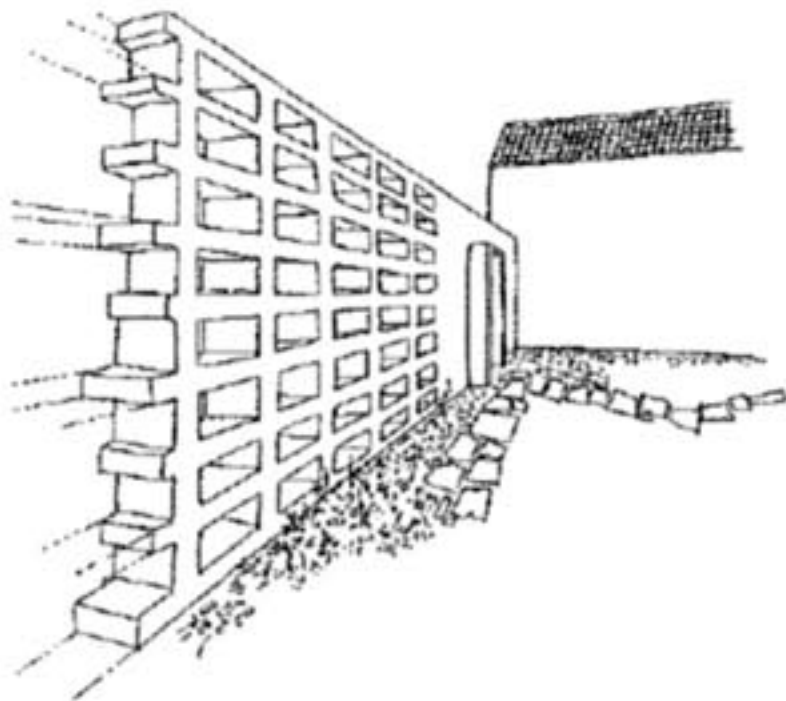

Arnstein house

Patios

The buildings are often endowed with a central courtyard, conceived as an open-air living room in which the walls become the frame for the ever-changing and marvelous picture which is the sky [see p. 196 ff.]; other types of "outdoor rooms" also play the same role. In some instances, the patio is shaded by a cloth cover or a pergola with vines.

Walled enclosures

Some buildings are surrounded by a walled enclosure. In certain outdoor settings, the enclosing wall is incomplete so as to open the open-air room to the panorama, or else it is pierced by a window, so that it may be traversed by the gaze which falls upon a selected view.

The walls are often solid, made of bricks or cement blocks. But they can also be perforated, in flat bricks or cement. The solution is described as "a pierced screen..., a sort of... adaptation of the convent grille as seen in Sicily or Spain, or of the wooden *moucharabié* of Moslem lands,"²⁵ but Rudofsky wants it to "never look forbidding", to "make [the passer-by] feel curious rather than unwanted."²⁶

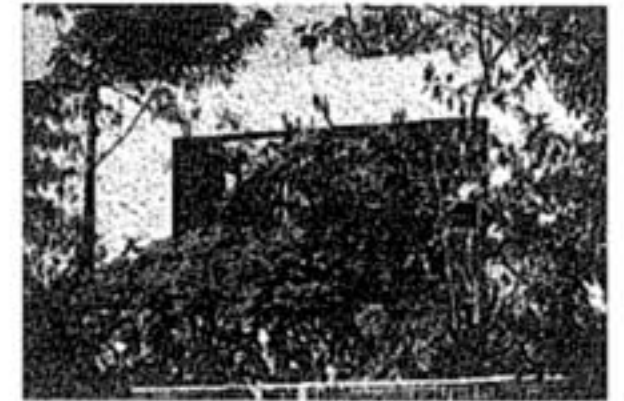

G. E. Kidder Smith. Frontini house's buffer garden, seen from the road, 1942.

Rudofsky creates here a low outer wall surmounted by a metal grille and a sort of inner masonry monumental arch. The result, completed by the rich vegetation, is totally protective of the front garden's privacy: it is almost invisible from the street, in spite of the relative permeability of the double enclosure.

Solariums

The open-air room giving off the master bedroom is generally meant as a solarium. It is distinguished from other outdoor rooms by the controlled access through the bedroom and, sometimes, by paved surfaces that make it possible to lie down comfortably in the sun; these may be distributed in such a way as to exploit the sun's rays at various times of day.

Smooth white walls

Rudofsky's walls are white, in part so that they will take on, according to the time of day, the varying colors of the atmospheric light; and they are smooth, so that they may receive the shifting shadows of the surrounding vegetation, almost like a mural.²⁷ This is one of the most convincing instances in which he, while adopting a solution that is in formal agreement with modernist architecture, eliminates the latter's theoretical superstructures in order to express a personal poetics derived from experience.²⁸



Bernard Rudofsky. Shadows projected by vegetation on a pillar in La Casa's garden, 1982 (?).

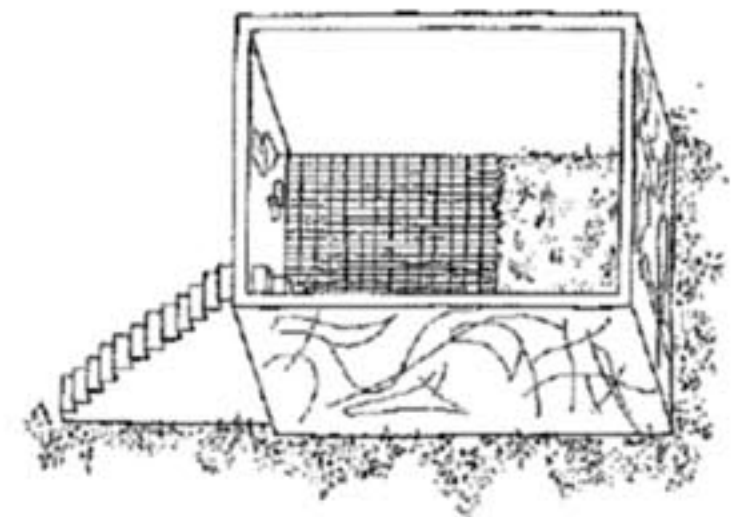

Nivola house-garden

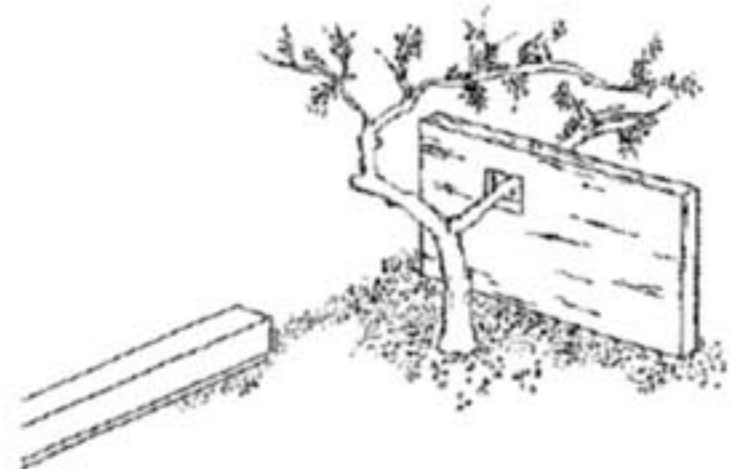

Nivola house-garden

25 AR44.1, p. 68.

26 TKM, p. 116.

27 BR43.3, p. 55.

28 In "Di un'architettura coloniale moderna (2)", *Domus*, June 1931, C.E. Rava had already spoken of "the enormous environmental value acquired by a simple white wall half-covered by crimson bougainvillea bushes, against the blue African sky."

Free-standing walls

In some works, Rudofsky puts up free-standing walls that take on a primarily plastic value. Sometimes the wall is perforated to permit its intersection with plant life. Stanley Abercrombie has commented: "[T]his is a symbol, surely, of what the Rudofsky design is all about: a marriage of structure and land."²⁹

Trellises

In his outdoor rooms, Rudofsky often uses light elements in wood or cement, composed in such a way as to define perceptually significant places while remaining completely permeable to the gaze.

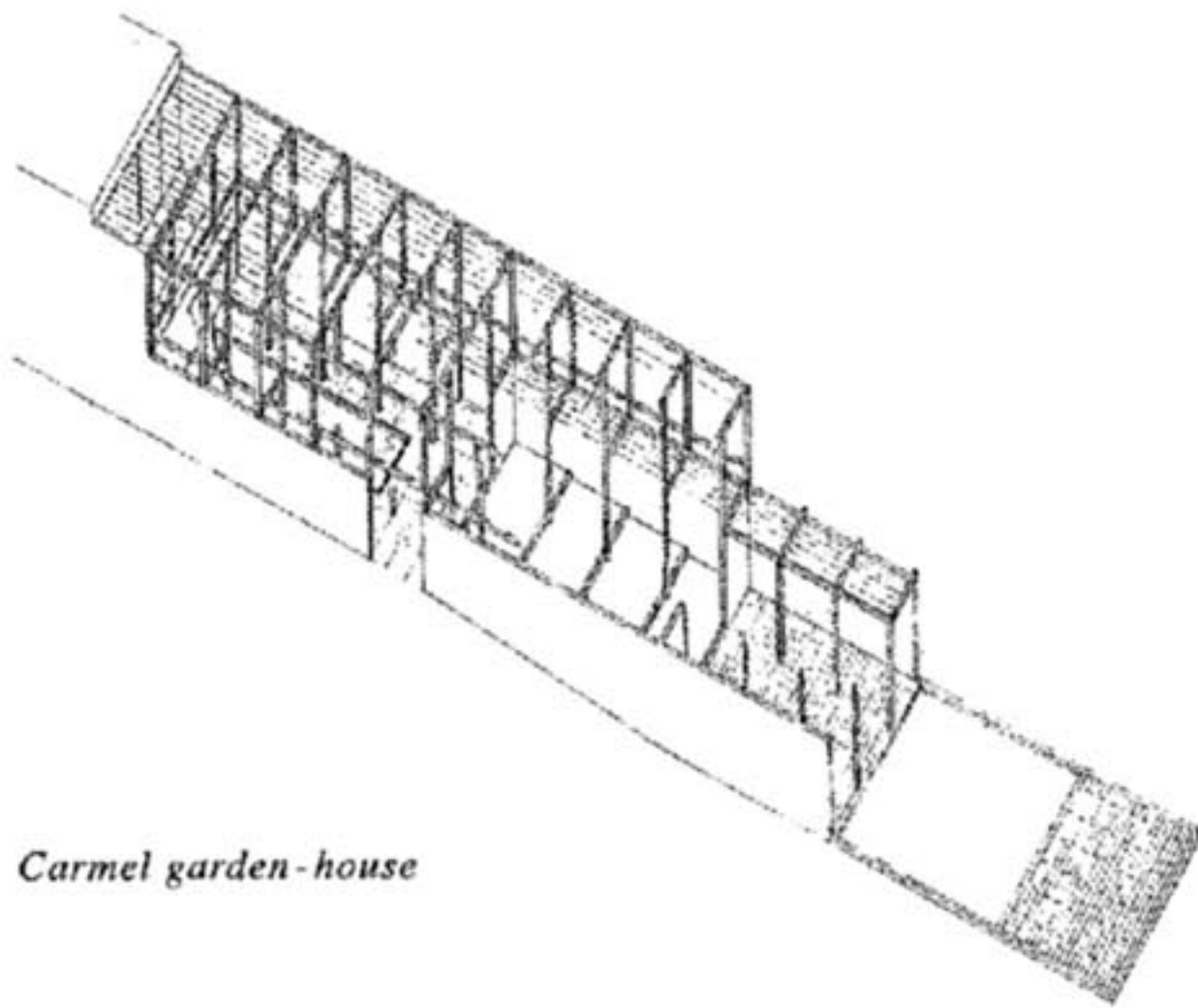

Carmel garden-house

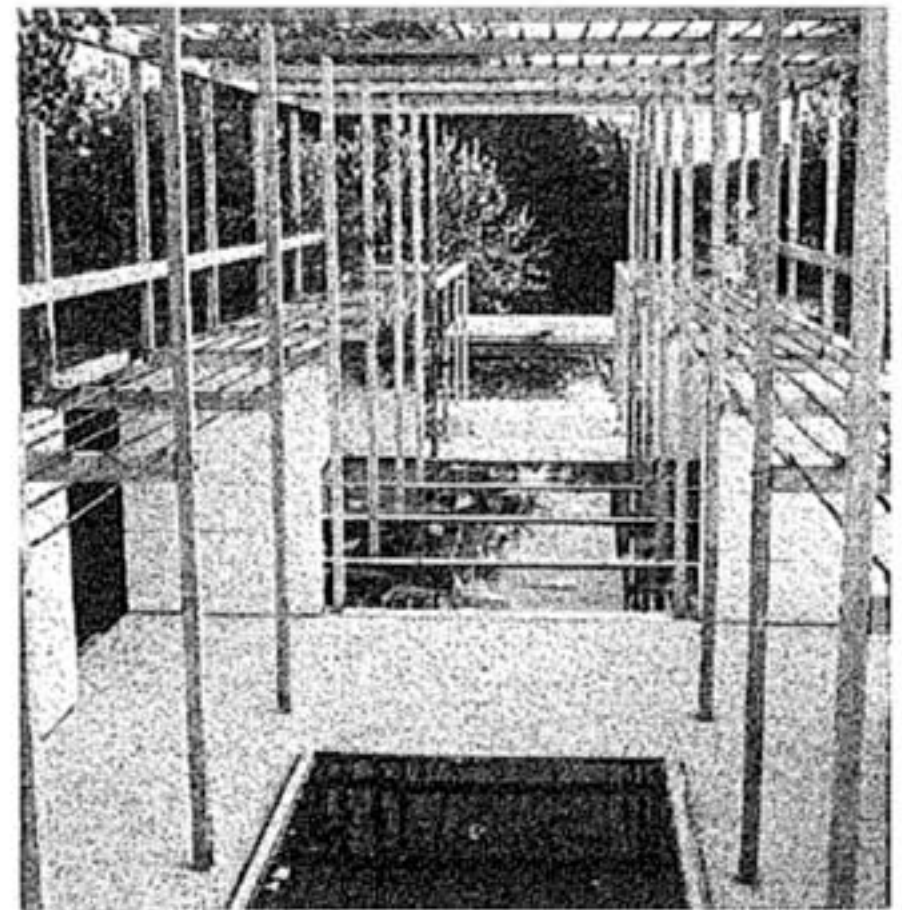

Bernard Rudofsky (?). Carmel garden-house's terraces and pools, 1963 (?).

The pergola constitutes an immaterial enclosing structure, with roof and walls.

A play of terraces and platforms on several levels, it is meant, above all, to establish a relationship with the space delimited by the surrounding wall, even if it visually goes beyond the wall to cast an eye on the landscape.

Vegetation

If pre-existing, it plays a considerable part in defining the building's planimetric layout: trees are preserved, and the position of the rooms is designed around them. Whether extant or newly planted, the vegetation lends variety to the open-air rooms and enhances, by contrast, the geometric shapes of the architecture and the trellises, pergolas, and perforated walls. Native vegetation is always chosen.

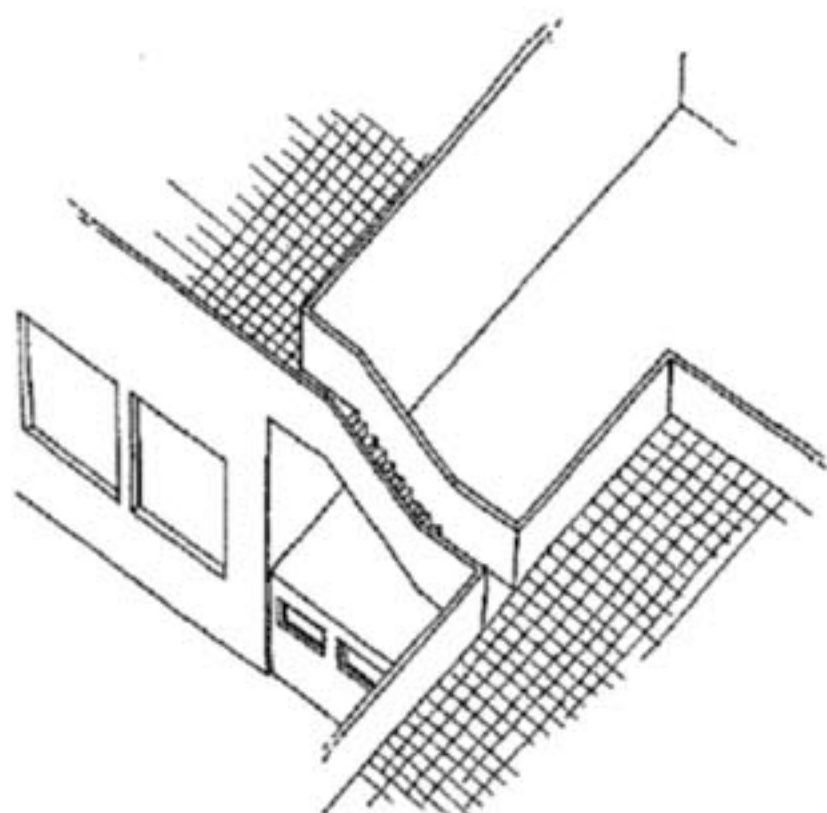

School in Hietzing

Terraces

Rudofsky's houses are often introverted: the relationship with open space is resolved in the limited space of a courtyard. There are also, however, instances of terraces situated on flat roofs, often reached via an outdoor staircase. In buildings occupying an isolated and dominant position, the interplay of the various levels of terraces, balconies, and platforms takes advantage of the terrain and of panoramic outlooks.

29 AR84.2, p. 144.

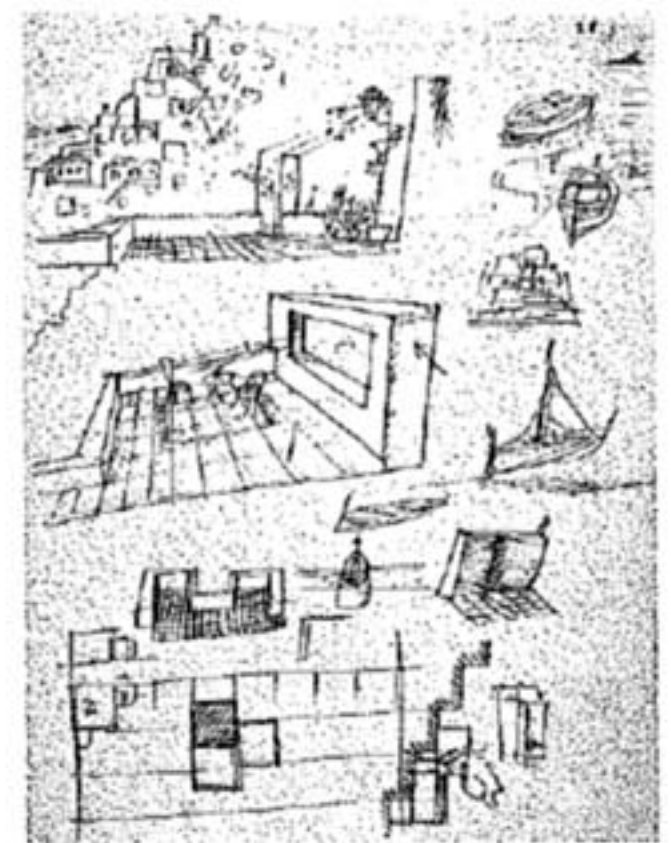

Bernard Rudofsky. Positano, terraces, boats, and other sketches, related to the "Alberghetto" project, 1937 (?).

In one of the terrace's walls, there is such a wide opening that its meaning is transformed to just delimiting the space and framing a view.

Staircases

Rudofsky prefers them to consist of a single rather steep flight, without a handrail. The steps of some indoor staircases are faced with decorated tiles. When the staircases are outdoors, they take on a primary role in the building's volumetric composition.

Many rooms

Rudofsky tends to prefer relatively small, well defined rooms, with separate and clearly marked functions.

The bedrooms are always separate from the dressing-rooms; bathrooms are often separate from the toilets. The functional articulation of the rooms in many unbuilt houses is worth of interest.

Outdoors, too, Rudofsky suggests the creation of numerous, varied, and habitable courtyards and gardens on a small scale, without fearing that these rooms may be claustrophobic: "Walled in, the small piece of land visually expands rather than shrinks, and every subdivision seems to further increase its surface."³⁰

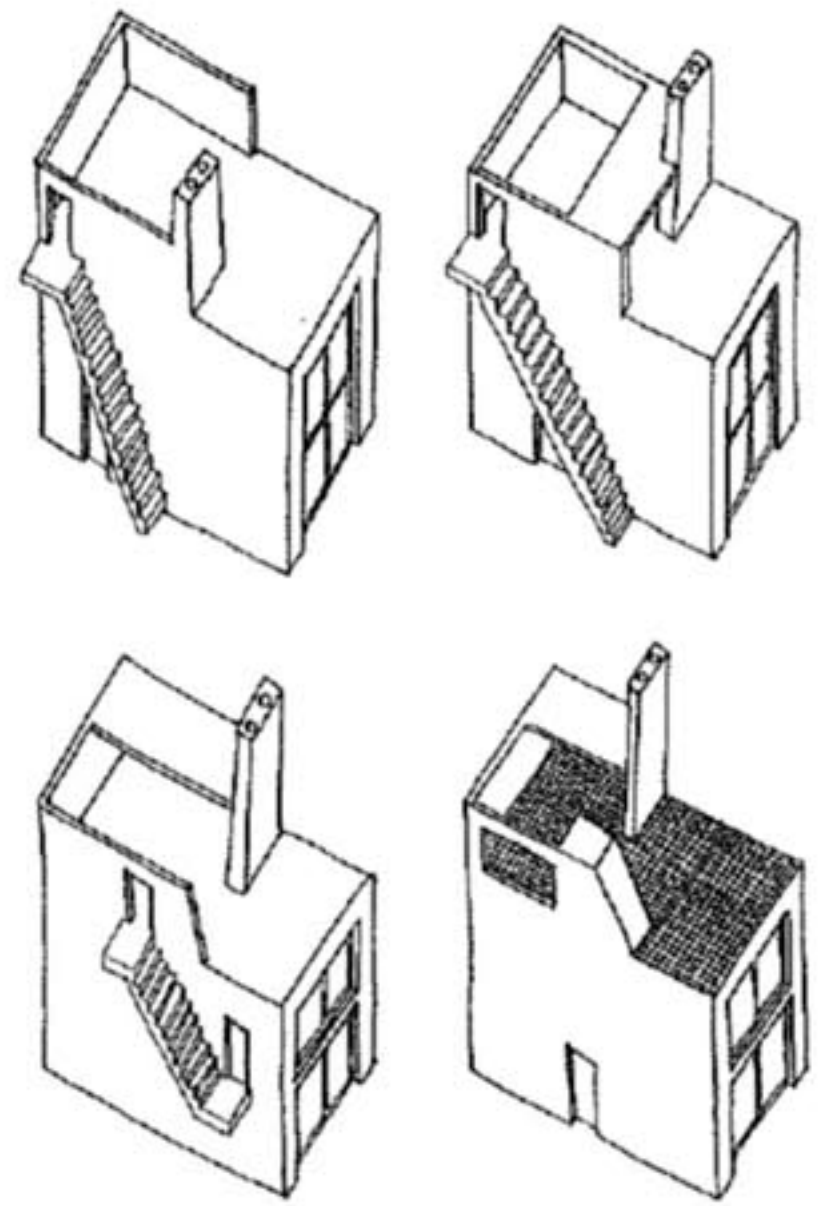

Marsicano house

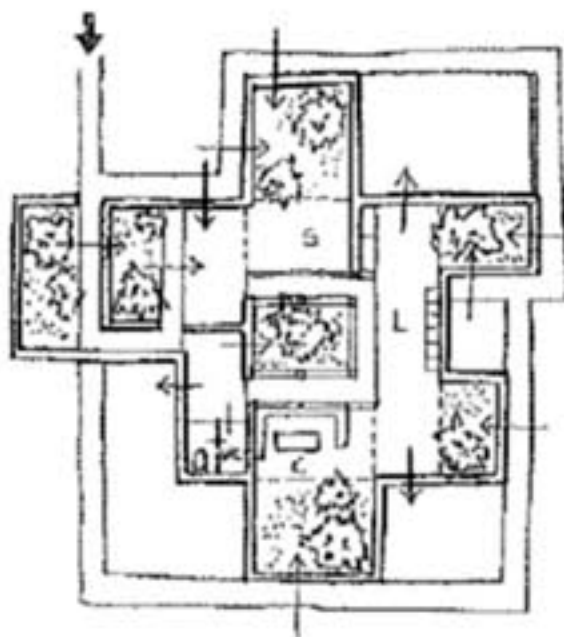

Ideal house (?), 1980

Fireplaces

A recurring archetypal element, often located outdoors or else — with two grates — built into the wall which separates indoors from out.

Indirect entry

In order to protect the intimacy of the house, and to make access gradual and provide a psychological demarcation for the change of environment, Rudofsky creates open-air and covered filter spaces, changes in the direction of the route, and entrances situated in a tangential position. The entry space often has a niche.

Windows

Even when they are light in structure, Rudofsky's houses are made up of material walls, into the mass of which the windows are cut. Windows offering a broad view are inserted into walls that are otherwise blind, so as to limit excesses of sunlight or thermal dispersion. Characteristic are windows — whether single or composed of several juxtaposed elements — set in a deep masonry box which juts out: a drastic and pure solution, an alternative to the *brise-soleil*.

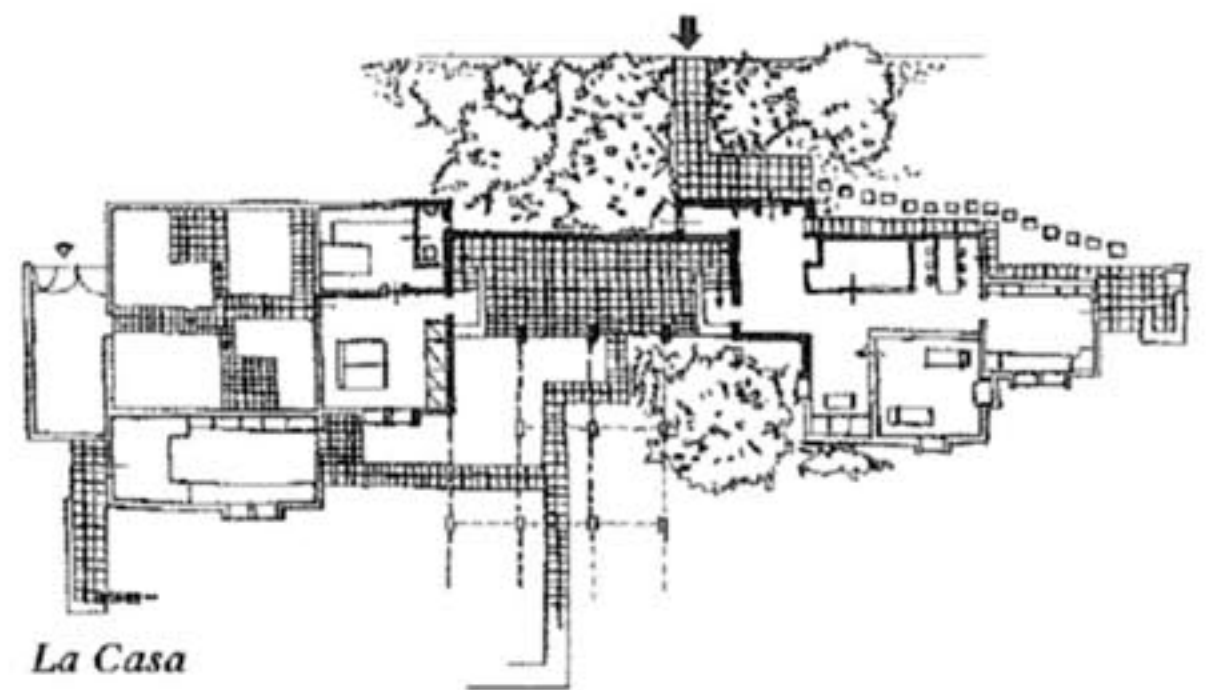

La Casa

Optical distillers

These are artifices for controlling and filtering natural light: devices such as, for example, straw screens, which can be put up or taken down by hand as needed, placed horizontally in pergolas or patios, but also vertically in front of windows, so as to obtain, in the interior, an "optical liquor," a more or less dense penumbra.³¹

Curtains

An effect of uniform shade is obtained, instead, in patios and solariums by means of curtains held in place by ropes: an element similar to the Sevillian *toldos*.

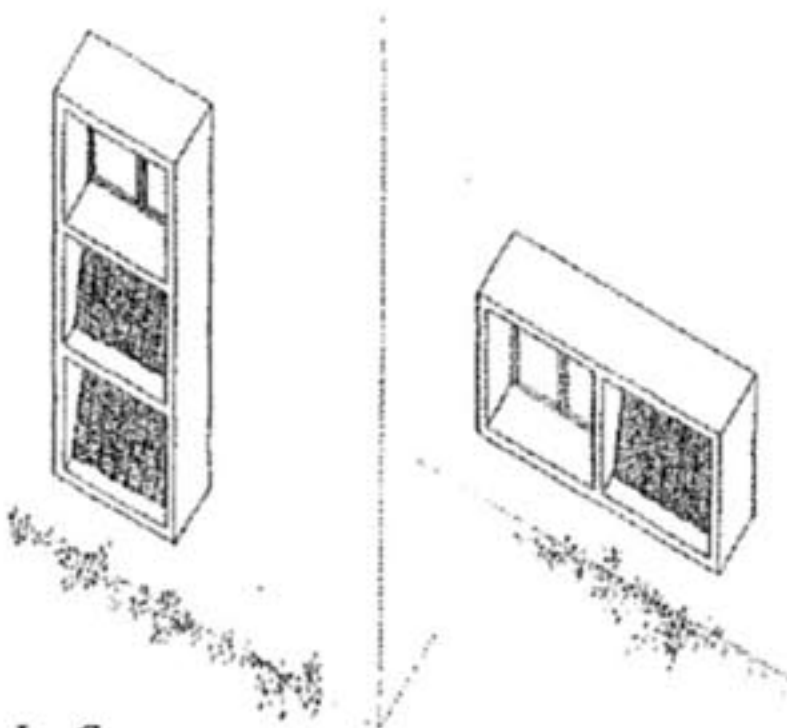

La Casa

30 BPW, p. 165.

31 SFP, BR85.1.

Gio Ponti. Seawards (east) elevation of the two Rooms of the Angels at the Hotel San Michele (designed by Ponti and Rudofsky), ca. 1938.

The human abstraction of white geometry intertwines with the organic irregularity of Mediterranean vegetation.

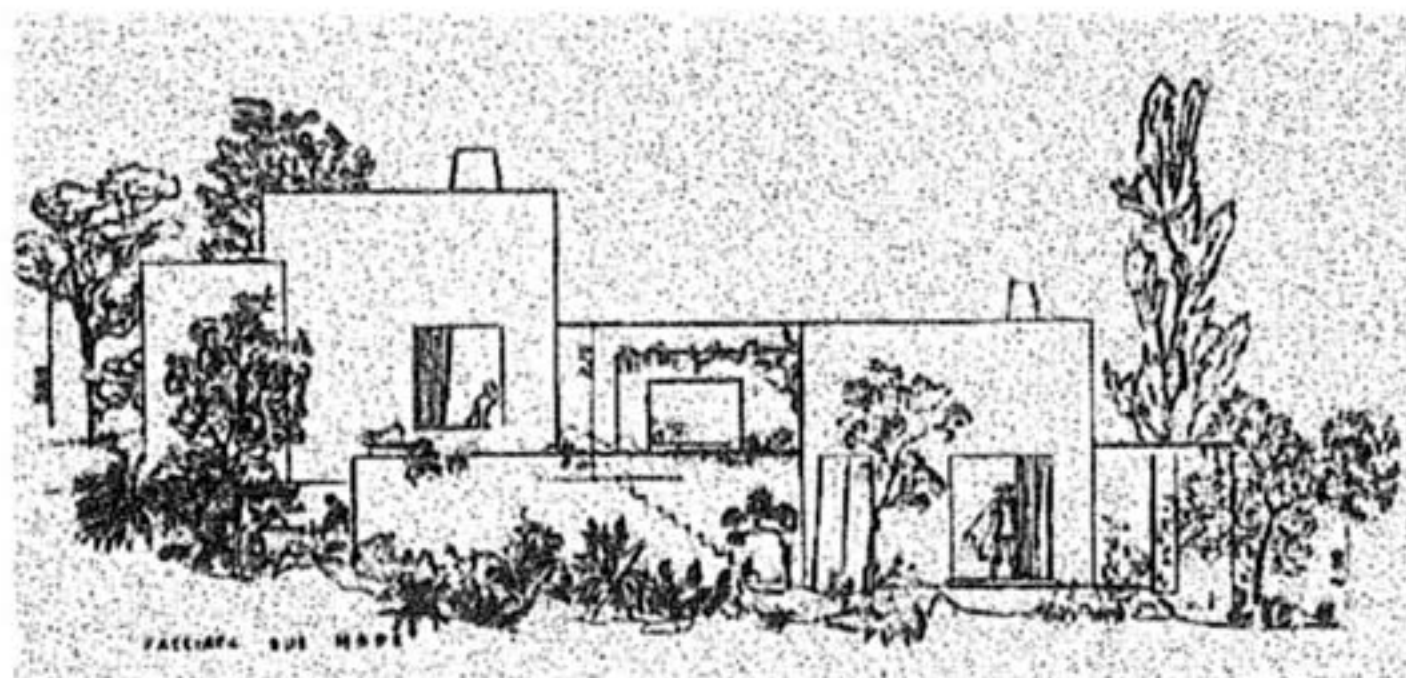

Mineral vs. Organic

The containers designed by Rudofsky so that people and activities may animate and fill them remain strictly neutral. Like Japanese traditional architecture, they do not imitate the sensuality of these people and activities; nor do they ever borrow their shape from them.

Rudofsky never contradicts his own hexahedral geometry: he never permits himself a free play of fantasy, as does, for example, Niemeyer. He rarely uses curved lines. Still less does he adopt an "informal" tone; he actually goes so far as to make fun of organic architecture. Even if he postulates an architecture that is the "vase of life," Rudofsky remains formally quite distant from the aesthetics of the house as shell. Puritanism and fidelity to his modernist background lead him to spurn the cult of spontaneity, "a 'regressive utopia' with nostalgic overtones, [characterized by] informal floor plans, artisanal building techniques, details that smack of dialect,"³² even if he unintentionally offers illustrations and arguments that favor the development of such a stance. In both architecture and dress, Rudofsky rejects a nostalgically historicizing or exoticizing vision.³³

Like Josef Frank, Rudofsky states that "the further the forms of architecture are from those of nature the better they will be."³⁴ No living being has a rectangular shape. "Nothing is further removed

³² Manfredo Tafuri, *Storia dell'architettura italiana 1944-1985*, Torino: Einaudi, 1986, p. 326.

³³ ACM, p. 180. Cf. also Adolf Loos, "Regeln für den, der in den bergen baut", op. cit.

³⁴ Christopher Long, "Space for Living: The Architecture of Josef Frank", in Nina Stritzler-Lavine (ed.), op. cit., p. 91.

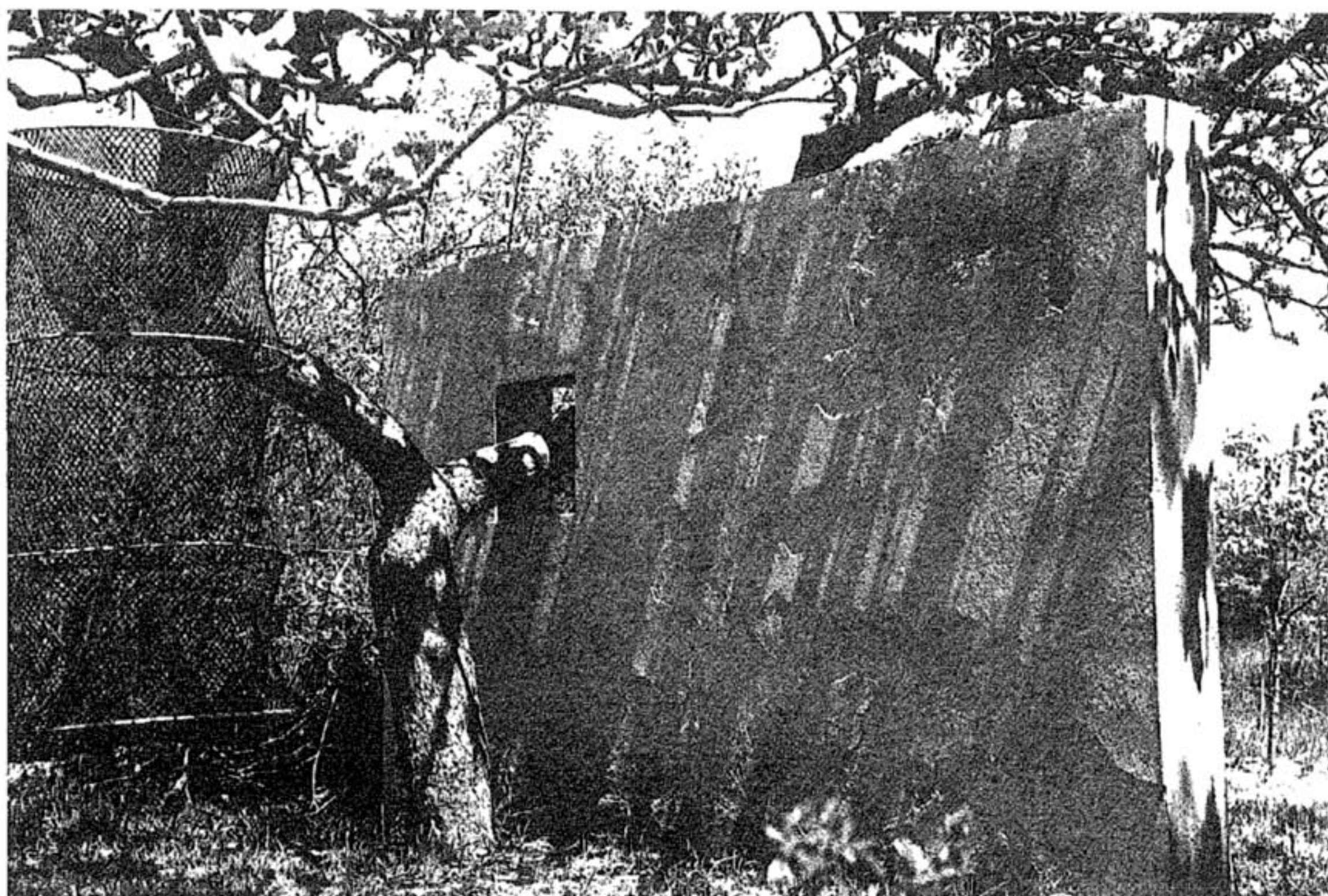

from nature than a T-square,"³⁵ and it is precisely for this reason that Rudofsky's rooms are rectangular. It is life that is organic; architecture is undoubtedly mineral.

So cool white geometrical spaces intersect with gnarled, leafy branches bearing multicolored flowers; when the inhabitants are not naked they contribute, with their lively clothing, even more color to the scene. Even in his Brazilian houses, there exists a precise poetical desire to keep everything firmly in its own field. Nature displays its exuberant richness; while architecture offers its geometry, the product of rational thought — but serenely, not frigidly. Perhaps it was this clear-cut decision that enchanted the critics of the period.

The most efficacious symbol of Rudofsky's entire architectural output is the bare, free-standing wall, traversed by the branch of an apple tree, in the garden of Costantino Nivola. Rudofsky uses this image to express many concepts: the complementary roles of nature and artifice in the construction of a livable environment; the relationship between natural form — given, organic — and the form created by man, which is the fruit of geometrical abstraction; architecture as a pure form of art when it has no utilitarian function.

Rudofsky was not the first to include trees in walls or in semi-open horizontal structures; but he was, perhaps, the only one to provide a convincing poetical justification for doing so.³⁶

Bernard Rudofsky. Nivola "house-garden"'s living sculpture, formed by an apple tree that puts one of its branches through a hole in the cement-block wall especially put there for this purpose, ca. 1951.

"The rough bark of the tree and the smooth surface of the wall enhance each other's qualities by contrast, while the shadowgraphs of the branches supply a mural which changes from hour to hour with the movement of the sun and from season to season with the coming and going of the leaves" (AR52.2, p. 270).

35 Bernard Rudofsky, unpublished notes.

36 BR52.2 (here at page 196 ff.); and also TPB, p. 8 ff.

Purposeless Architecture

In an analogy with the most widely shared hypotheses regarding the origin of clothing,³⁷ in *The Prodigious Builders* Rudofsky speculates that architecture was likewise not born to satisfy functional necessities.³⁸ His choice of the example of Stonehenge, and the slightly frivolous tone of his discussion of the most curious theories regarding the original purpose of this archeological complex, are not entirely convincing. As on many other occasions, he does not succeed (or is not interested) in adopting a rigorous tone of discourse — even if his provocative suggestion that Stonehenge is, above all, playful can, perhaps, be related to Huizinga's definition of the ludic as "first and foremost...a free act."³⁹ Whatever Rudofsky's reasons for seemingly setting aside the magical and religious hypotheses concerning the origin of architecture, it is possible that his most urgent intention is to state that immediate, material motivations are not the basis for creative acts: a position that may, perhaps, be shared by archeologists and anthropologists.

Such a stance may perhaps seem to contradict the very extensive portion of Rudofsky's work devoted to achieving a correspondence between the outcome of a design (in architecture, but not only in architecture) and the concrete needs of daily life.

But while, for him, the ideal garment is pure art, pure ornament (because clothing, under ideal conditions, is not "necessary"), the house — which satisfies, instead, a need (primarily the delimitation of a private space) — belongs more to the category of useful instruments than to that of artistic objects. Thus Rudofsky can attribute a condition of sublimation to architecture precisely on those occasions when it is useless.

In absolute terms, for Rudofsky the rule is: "There is no better criterion for an art work than its uselessness."⁴⁰ Of some maps bought in Japan, he says: "I have been repeatedly assured that their practical value is negligible, which only strengthened my conviction that they are art."⁴¹

37 John Carl Flügel, *The Psychology of Clothes*, London: The Hogarth Press, 1930.

38 TPB, p. 96–97.

39 Johan Huizinga, *Homo ludens. A Study of the Play-Element in Culture*, Boston: Beacon Press, 1966 (1950).

40 Bernard Rudofsky, unpublished notes.

41 Bernard Rudofsky, unpublished notes.

Bernard Rudofsky. Multistoried, 40-foot-high lemon pergolas climb the shores of Lake Garda in northern Italy, 1949.

Rudofsky loved architectural elements isolated in space, disjointed, apparently functionless, like inexplicable ruins (AWA, p. 111–112). The lemon-houses of Lake Garda (nicknamed by him "Klingsor's Temple") were, for him, an architecturally potent symbol, and contributed to the inspiration for some of his works like the pergolas of La Casa.

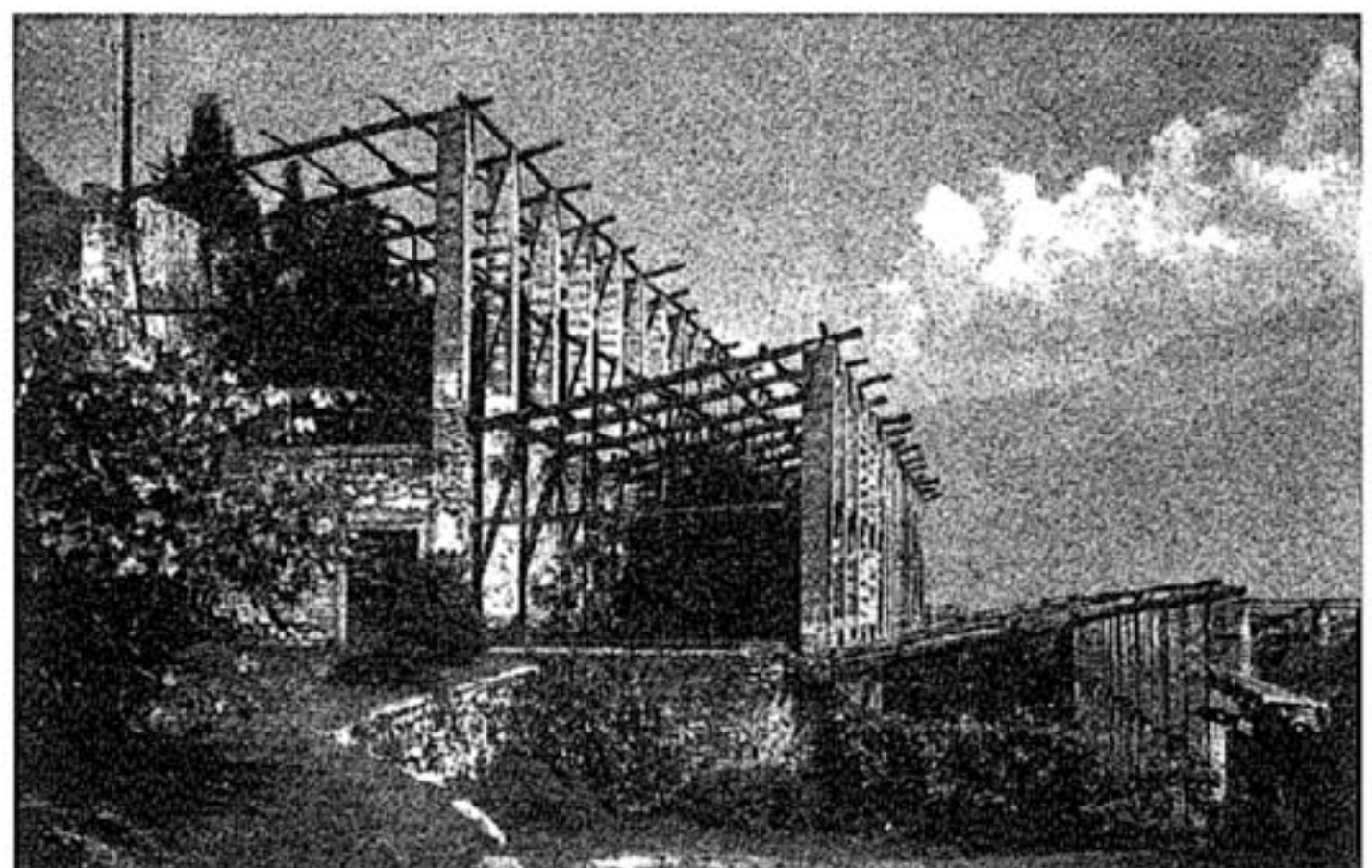

The lack of usefulness should be understood as the absence of pragmatic ends, since it is clear that he does not intend to idealize a condition of absolute gratuitousness. He thinks, rather, that art serves the purpose — wholly distinct from that of instruments — of being nourishment for the soul. Architecture at its purest has the sole purpose of creating the space for an emotional experience.⁴²

Rudofsky shares the Ruskinian principle according to which architecture has the task of contributing to the mental health of the inhabitant.⁴³ This is achieved, first and foremost, through intimacy and isolation, which permit a high quality of life and the cultivation of a psychophysical equilibrium that keeps the inhabitants capable of clear thought, masters of their own bodies, and ethically healthy. For decades, more or less isolated writers — including Wright, Loos,

On the House

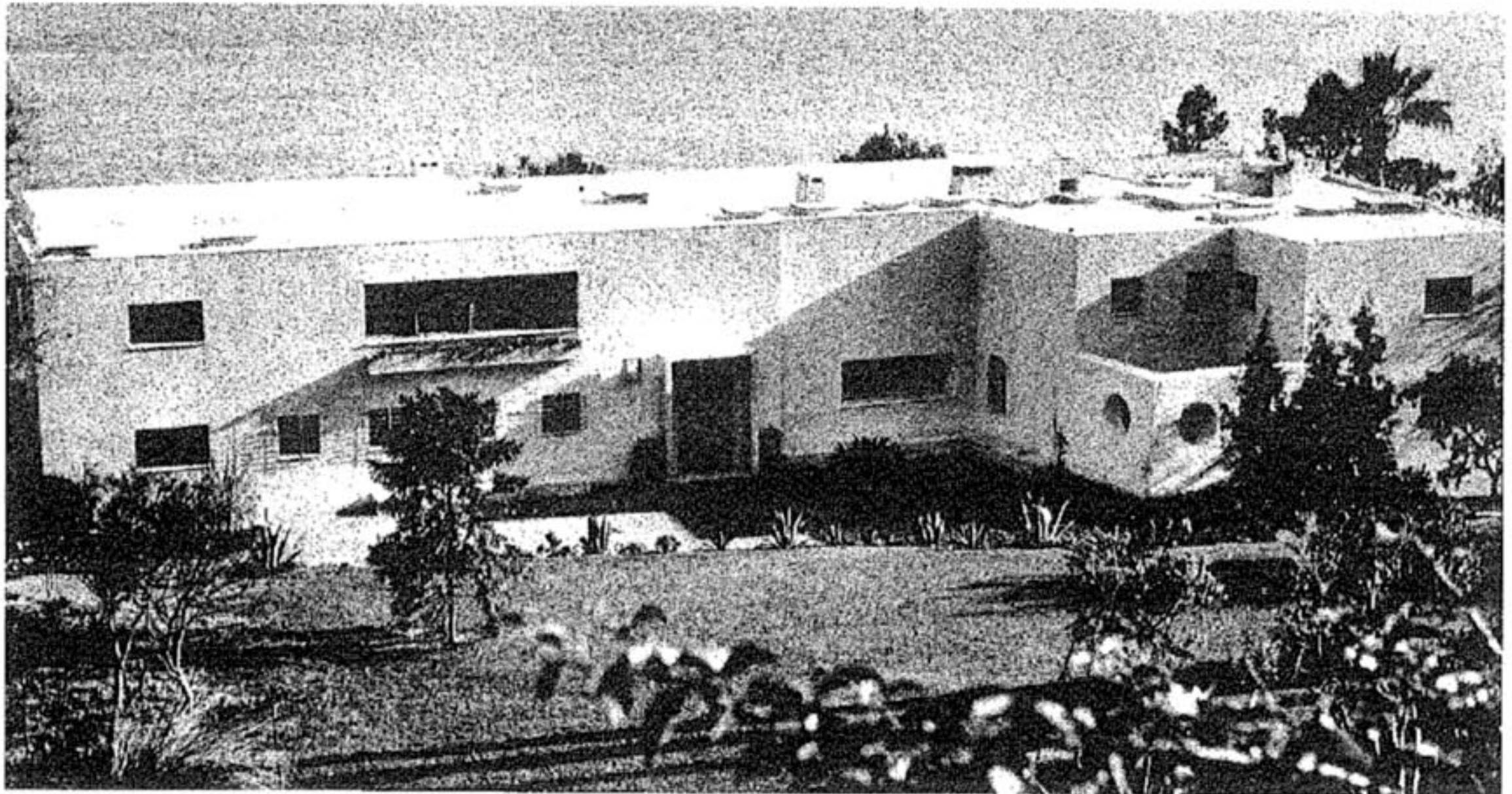

and Frank⁴⁴ — spoke of the house as a refuge where the inhabitant could rediscover an individual environment of detachment and serenity. In a later period, others investigated the relationship between buildings and health, both in the bio-architectural and medical fields⁴⁵ and from the psychological standpoint. Rudofsky thinks of a healthy and comfortable domestic environment for the whole person, where architecture and behavior together make up a place for a happy life.

Ponti asks that the house respond to a "thirst for a poetic life," and that it satisfy the demands of both physical and spiritual life.⁴⁶ In his

Unknown photographer. Gio Ponti, villa Donegani, Bordighera, 1940.

42 Bernard Rudofsky, unpublished lesson in Copenhagen # 4, 7 April 1975.

43 BPW, p. 198.

44 Frank Lloyd Wright, *The Natural House*, New York: Horizon Press, 1954; Christopher Long, *op. cit.*, p. 88; Josef Frank, *Architektur als Symbol*, *op. cit.*

45 Christopher Day, *Places of the Soul*, Wellingborough: The Aquarian Press, 1990; David Pearson, *The Natural House Book*, London: Gaie Books, 1989.

46 Gio Ponti, 'Una villa alla pompeiana', *Domus*, n° 79, 1934, p. 16-19.

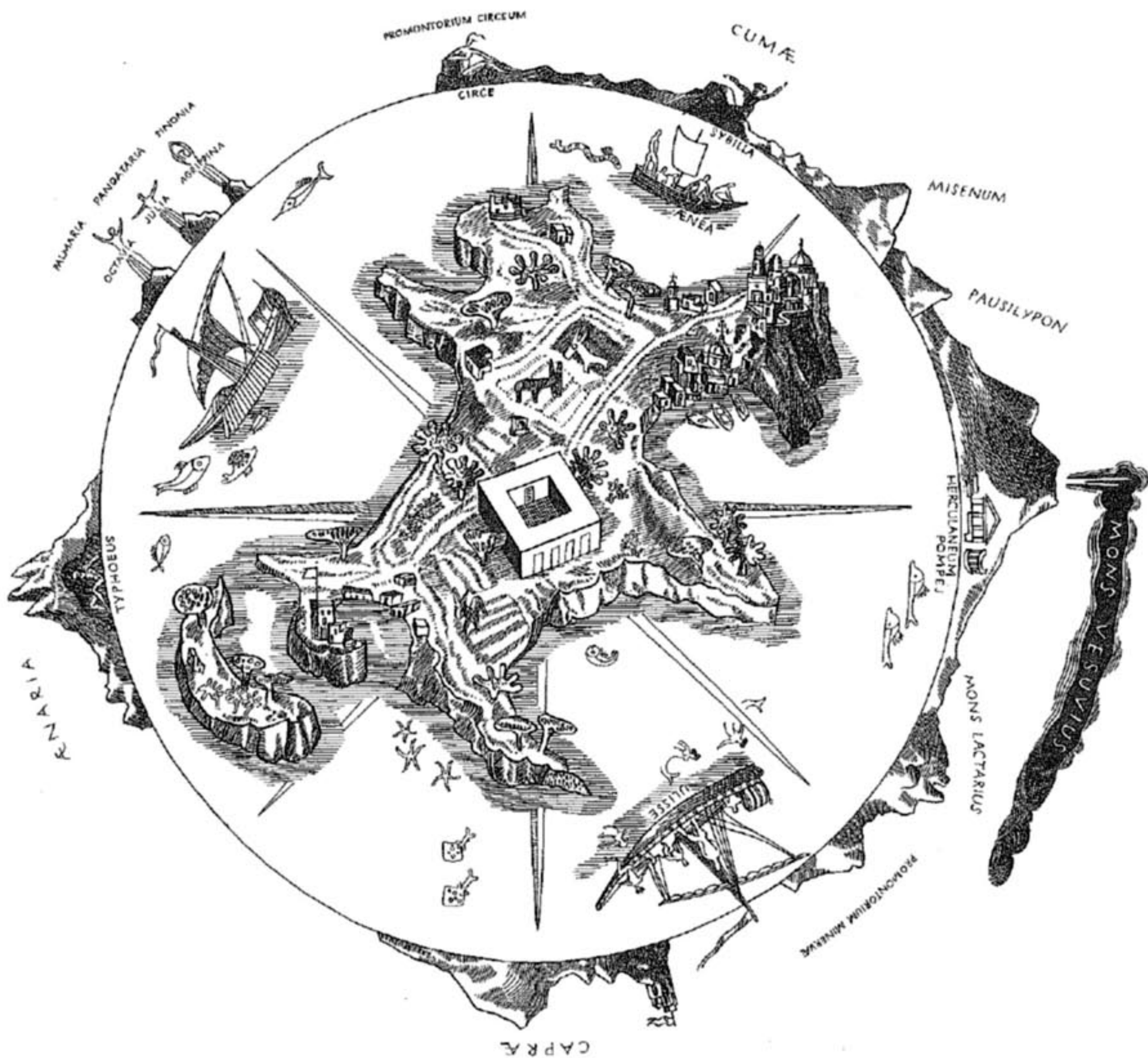

Bernhard Rudofsky. Orientation map of the island of Procida, ca. 1935 (?).

In the middle of the drawing, the square house with its square courtyard. The Procida house plays the role as center of gravity, organizing perception of the tangible and mythical world.

A few years before, Edwin Cerio had drawn an anamorphic map of the world, centered on Capri island.

manifesto, the house is "the place chosen by us to enjoy during our life, in happy possession, the beauties of which our lands and our skies make us a gift for long seasons;" the "Italian-style house [gives us], through its architecture, a measure for our own thoughts, ...with its simplicity, health for our customs."⁴⁷ The parallel between these words and Rudofsky's vision is so complete as to help explain a friendship that lasted a lifetime.

For Rudofsky, the house is the vessel for inwardness, sensations, independence of judgment: the place where completeness of being is achieved. In *The Prodigious Builders*, his treatise on architecture, Rudofsky describes the house in terms of intimacy: it is "the repository of our wishes and dreams, memories and illusions. It is, or at least ought to be, instrumental in the transition from being to well-being."⁴⁸ This idea is in line with Bachelard's theory according to which "houses are elements of integration for thoughts, memories, and dreams; they are the place of our own personal stories, they gather up the spaces of our solitude, they are the spaces of our felicity, our well-being."⁴⁹ For Bachelard, an authentic house offers the space for a personal identity, a center of gravity against dispersion in the ocean of possibilities in which modern man finds himself immersed.⁵⁰

The homes theorized by Rudofsky contain no religious symbols; their form and orientation have no cosmogonic meaning.⁵¹ Their sacral quality is very concrete and sensorial; it resides in silence and simplification. Their intimacy is necessary for the cultivation of a spiritual equilibrium, but also in order to let one lie naked while soaking up the sun.

To be sure, this condition is easily achieved in a wealthy villa surrounded by ample spaces that insulate it; but Rudofsky demonstrates that it is also attainable on an urban lot. His ideals are Pompeian or Arab atrium houses, which, with their dense texture, can make up entire cities, and the traditional Japanese house, with its socially codified low level of sound: models of introversion and intimacy, not for the privileged classes alone, but the normal habitats of entire societies.⁵² Rudofsky designs single-family dwellings for the *haute bourgeoisie*, but his goal is not to serve the élite. He holds that the problem of the quality of the dwelling poses itself at an individual level, independently of the economic possibilities of the inhabitant, and that principles underlying primitive and popular domestic solutions are also valid for a modern urban house.

The decision to work only on the scale of the single dwelling unit is the result of a conscious choice. Like Frank, Rudofsky disagrees with the approach according to which "the dwelling must, by now, be considered as collective service equipment, like the school, the hospital, etc."⁵³

47 Gio Ponti, "La casa all'italiana", *Domus*, n° 1, 1928, p. 1.

48 TPB, p. 12.

49 Gaston Bachelard, *La poétique de l'espace*, Paris: PUF, 1957.

50 AR97.1, p. 202.

51 Mircea Eliade, *Le mythe de l'éternel retour. Archétypes et répétition*, Paris: Gallimard, 1949; Joseph Rykwert, *On Adam's House in Paradise: The Idea of the Primitive Hut in Architectural History*, New York: MoMA, 1972; William Alexander McClung, *The Architecture of Paradise. Survivals of Eden and Jerusalem*, Berkeley: University of California Press, 1983.

52 TKM, p. 244; 261.

53 Georges Teyssot, "L'invenzione della casa minima", *La vita privata. V. Il novecento*, Roma-Bari: Laterza, 1988, p. 184.

Model of single-story residential units in the "new town" of Chimbote (Peru). Designed by J.Ll. Sert and P. Lester Wiener, ca. 1945.

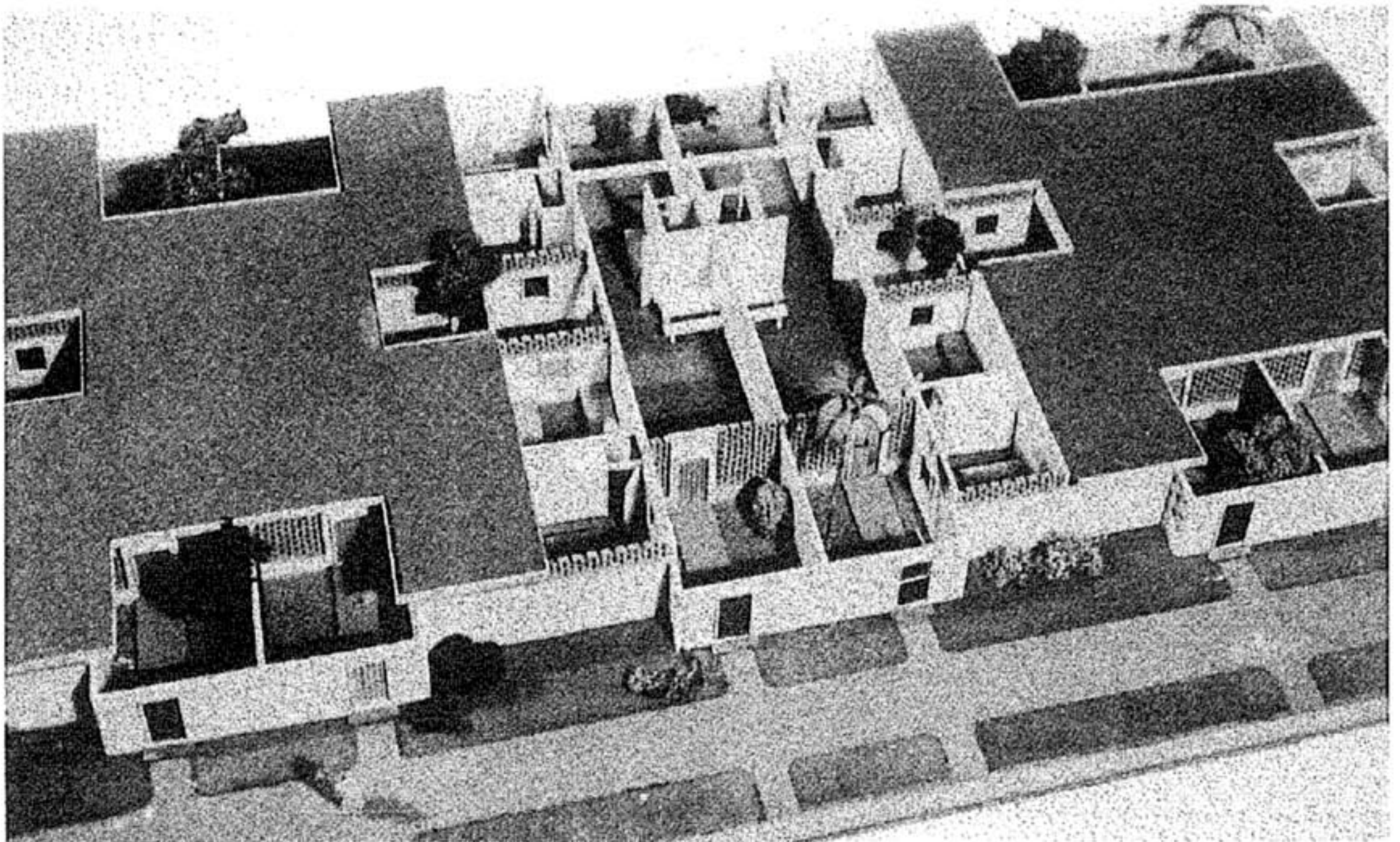

Serge Chermayeff and Robert Gordon. Plan of a single-storied residential unit with six courtyards, early 1960s (?).

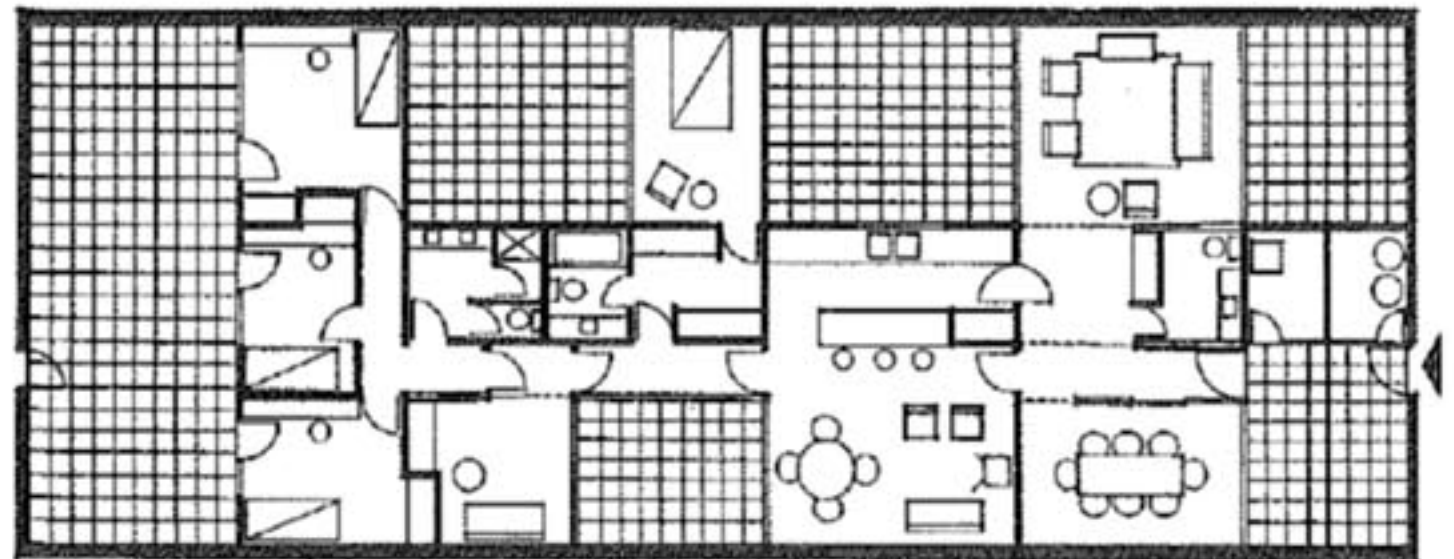

The large-scale settlements theorized by Taut⁵⁴ and other socialist and democratic architects make him uneasy, all the more so if they are on many floors; this is because they annul the distinction between public and private, the crowd and the individual. On the other hand, he appreciates the work of Chermayeff on residential modules that can be added together, as well as Neutra's low-cost mass housing programs.⁵⁵

54 Bruno Taut, *Ein Architekturprogramm. Flugschriften des Arbeitsrates für Kunst*, Berlin, 1918 (also in: *Arbeitsrat für Kunst Berlin 1918-21* (catalogue of the exhibition at the Akademie der Künste), Berlin, 1980).

55 Serge Chermayeff, Christopher Alexander, *Community and Privacy. Toward a New Architecture of Humanism*, New York: Doubleday, 1963; Willy Boesiger (ed.), *Richard Neutra. Bauten und Projekte*, Zürich: Editions Girsberger, 1951 (I), 1959 (II).

Had Rudofsky designed multifamily buildings and subdivisions, would he have chosen extensive solutions in which every housing unit had its own private open space, like Libera's Tuscolano (1952) or Sert's projects in South America?⁵⁶ Perhaps Scott is right to say that it would have been ideologically impossible for Rudofsky to design collective buildings, because this would have been to impose a way of life on inhabitants he did not know. The supplying of housing in large quantities is at the antipodes from his idea of the house as the place in which existence is rooted.

Rudofsky's houses are conceived as containers for *otium*, leisure, that which makes life worth living; they are intended to let one forget the *negotium*, the business lurking outside the door. This is the exact opposite of the functionalist, materialist conception of the house, which sees it as a sort of workshop mechanically dispensing services. (Schindler must have had something of this sort in mind when he described the work of De Stijl and the Bauhaus as "an expression of the minds of a people who have lived through the first World War, clad in uniforms, housed in dugouts, forced into utmost efficiency and meager sustenance, with no thought for joy, charm, warmth."⁵⁷)

The idea of planned obsolescence likewise seems pure blasphemy, and — despite certain pages on nomadic dwellings, and the course of Rudofsky's own life — the idea of the temporary dwelling has no place in his architectural practice or his theories of domesticity.

A house can be sensual, both in its conformation — on account of its light, its sounds, the tactile qualities of its materials — and in the kind of life it is possible to live in it. Like Loos, Rudofsky is "an architect obsessed with the immediate quality of life in the spaces built by man, the quality of the smell, the quality of the texture, of every sensation;"⁵⁸ and he recognizes these qualities in the traditional Japanese house. "Perhaps only a people who never heard of Original Sin can conceive of a *sensuous* house, and by sensuous I do not mean the whorish trappings of 'interior decoration.' A Japanese room is as chaste as a seashell, so much so indeed that we have come to look at it as the quintessence of austerity. Yet in the Orient one finds austerity perfectly compatible with voluptuousness."⁵⁹

His houses are "pure, composed, smooth," and must be inhabited in a "clean and quietly vibrant quality of spirit."⁶⁰ The rarefied, factual sensuality sought by Rudofsky is entirely different from the intellectual, fetishistic eroticism of his contemporary Mollino, for example.⁶¹ More than the artifices of architecture — only rarely does Rudofsky put into practice his own suggestions for sensory stimulation — for him it is the education of the senses that confers sensuality on domestic life.⁶² He is a convinced hedonist, an aristocratic epicure; he addresses

56 Adalberto Libera, *Opera Completa*, Milano: Electa, 1989; Josep M. Rovira, *José Luis Sert. 1901–1983*, Milano: Electa, 2000.

57 Esther McCoy, *Five California Architects*, New York: Reinhold Publishing Corp., 1960, p. 153.

58 Joseph Rykwert, "Prefazione", in Adolph Loos, *Parole nel vuoto*, Milano: Adelphi, 1972, p. xxviii.

59 TKM, p. 119.

60 AR49.2, p. 6.

61 Cf. Giovanni Brino, *Carlo Mollino. Architettura come autobiografia*, Milano: Idea Books, 1985; *Carlo Mollino 1905–1973*, Milano: Electa, 1989.

62 Bernard Rudofsky, *Back to Kindergarten* (unpublished lecture in Copenhagen), 8 April 1975, p. 7 of manuscript.

himself to the "minority of uncontaminated humans with their minds intact."⁶³ Like Ponti, he understands modernity to be "aristocracy in the choice and...adoption of a measure and simplicity that matches the most educated needs, an attitude towards living, thinking, knowing, judging."⁶⁴ This refined hedonism is most efficaciously expressed in the Sparta/Sybaris antithesis that runs through all his work, and which becomes the title of his last exhibition. The sense is that the exercise of Epicureanism is nonetheless a moral choice entailing order and a rule of life. Here, his concordance with Gio Ponti is complete: "Style...is, precisely, discipline."⁶⁵

Rudofsky's designs were intended "to procure for those who live in them a life delicious in the slightest things."⁶⁶ The variety of environments and the felicitous details — the corner of a garden, a pergola, a bathtub, a closet, a wall — offer a place for the diverse phenomenologies of well-being, and are capable of creating that affability characteristic of a timeless architecture "without an architect."⁶⁷

Bernard Rudofsky. Looking southwards from villa Campanella's kitchen/fireplace area, ca. 1936.

From left to right: the food preparation counter, living room with two benches and two trees, outdoor shower (enclosed by the semi-circular wall), stairs and footbridge connecting the two upper floor areas.

Villa Campanella is the ideal stage for a life that combines the sensuality of contact with nature with a Spartan athleticism. It is also an extreme case of artificial planting (on a reef!), meant to populate the building with living presences that also take on a strong symbolic value.

63 ACM, p. 230.

64 Gio Ponti, "Falsi e giusti concetti nella casa", *Domus*, n° 123, marzo 1938, p. 1.

65 Gio Ponti, "Verso funzioni nuove", *Domus*, n° 82, ottobre 1934, p. 3.

66 AR49.2, p. 4: "The luxury of these villas doesn't lie in the cost of the fittings or in precious materials, but just in their delicate sense of exclusive destination, which relates them to the unrepeatable ancient villas. Their supreme courtliness didn't lie in wealth or vastness, rather in their being dedicated to realizing, with extreme precision and neatness, an idea: to procure for those who lived in them a life delicious in the slightest things."

67 Furio Fasolo, *Architetture mediterranee egee*, Roma: Danesi, 1942, p. v.

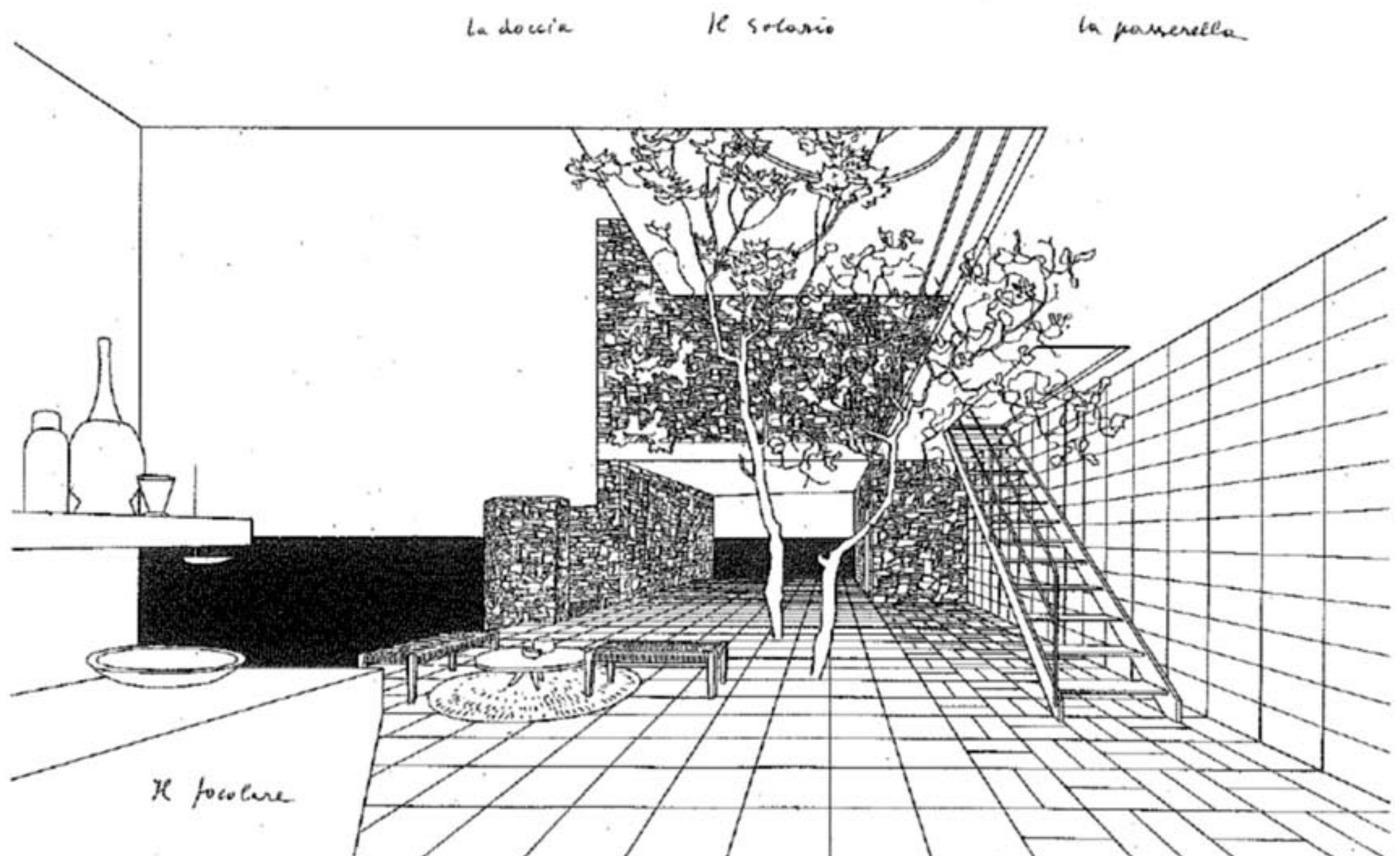

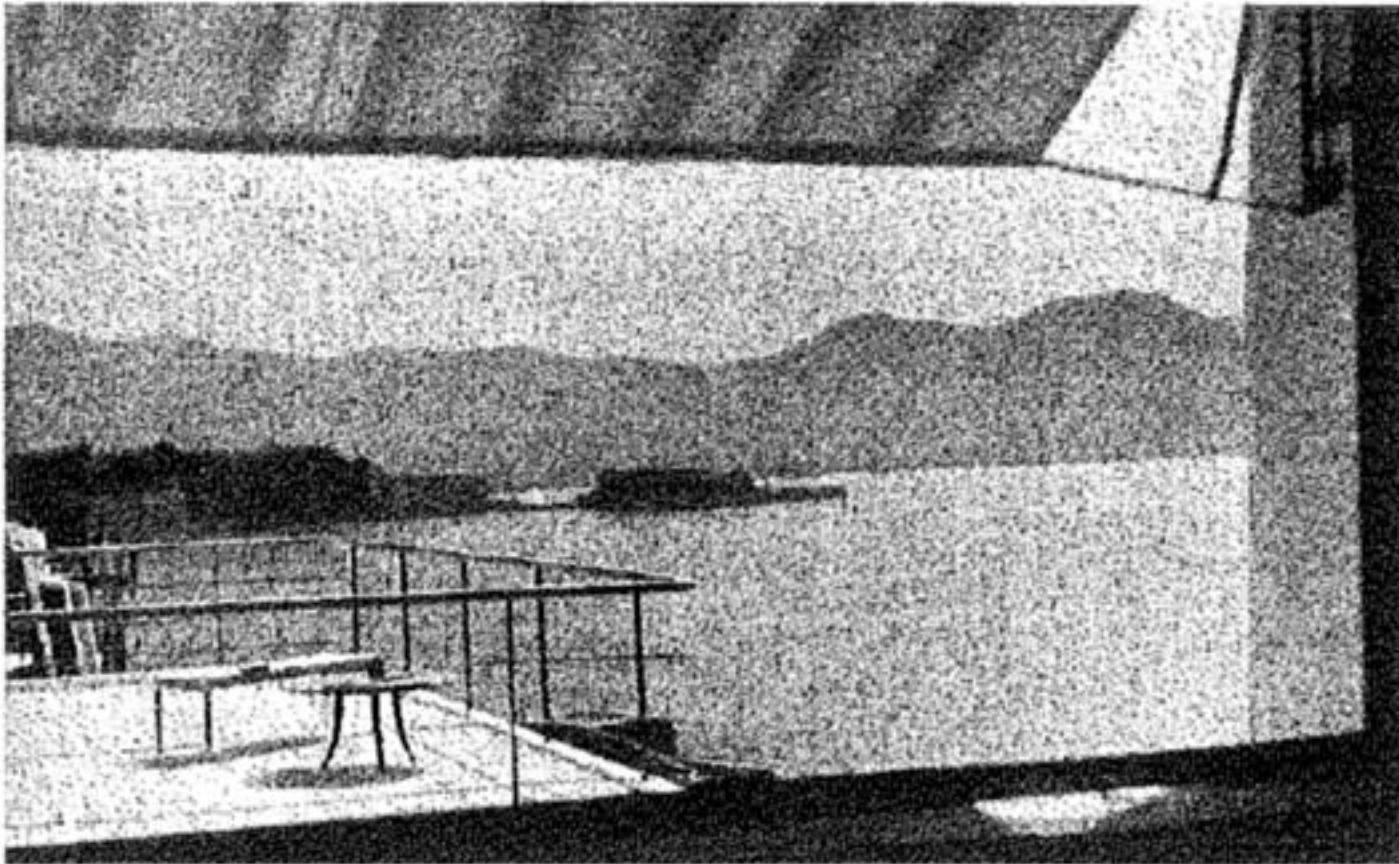

Bernard Rudofsky (?). Oro house: view from the side window of the master bedroom, looking towards the child's terrace; in the background, Santa Lucia and the Castel dell'Ovo, 1937.

The Oro house, like Brazilian houses, stands out in the context of contemporary buildings on account of its markedly modernist choices, but does not put into question the haut bourgeois social habits of his clients.

In the buildings actually constructed (I am thinking of the Oro, Hollenstein, Frontini, and Arnstein houses), Rudofsky accepts the way of life of patrons who have come his way more by chance rather than from acceptance of his proposals for the reform of domestic life. Rudofsky published these proposals in 1938 in *Domus*, as a commentary on his project for a house for Berta Doctor and himself on Procida: necessity having reduced this project to the occasion for a theoretical discourse, he makes it the nucleus of his entire exploration of habitation.⁶⁹ The recourse to a Roman-Italic model of dwelling — so far from the then-current types, even if “rationalized” — allows him to place a polemical emphasis upon the habits of modern Western life.

The design for Procida is the most fully developed of a long series of unrealized projects for houses for himself and his wife and for ideal houses.

The house that Rudofsky finally succeeded in building to live in in 1969–71 in Andalusia is consistent with the road along which he had set out in his designs from the thirties onwards. In keeping with his intolerance for the contemporary obsession with change, the principles of design and the appearance of this house do not deviate from those of the houses designed more than thirty years earlier; the differences are due to the site and the requirements. However, here he does not apply many of the ideas set forth in 1938, conceived for a house in a not-so-different cultural and climatic context.

In short, he does not build, and perhaps he does not even plan — whether for himself and his wife or for a client — a house uniting the pure architectural volumes and admirable unroofed spaces recurrent in his output with the reforming, cosmopolitan ideas about domestic functions enunciated in his writings.

Ein Rudofsky-Haus zu bauen?⁶⁸

See What's Needed... at p. 175 and Catalogue no. 12 (p. 261)

See Catalogue no. 64 (p. 304)

See On the Art of Living, p. 67 ff.

68 Hans Hollein (AR86.6) suggested: “It wouldn't be devoid of interest if after a Hundertwasser-Haus there also arose a Rudofsky-Haus.”

69 Cf. NIL, p. 5.

Intimacy and Articulation of Indoor and Outdoor Spaces

Some houses offer their inhabitants an articulation of open spaces. The principle is to supply every indoor room with a corresponding, equally intimate and well articulated outdoor space. Having successfully applied this idea in the Arnstein house (where there are 5 "outdoor rooms"), Rudofsky experiments with it in the house for himself and his wife at Amagansett (3 open-air rooms); in the Latin-cross-shaped house; in Andalusia (at least 5); and in the ideal house of 1980 (4). The garden surrounding the Frontini house is articulated in distinct areas, permitting it to be put to several separate uses at the same time.

See Catalogue no. 30 (p. 277)

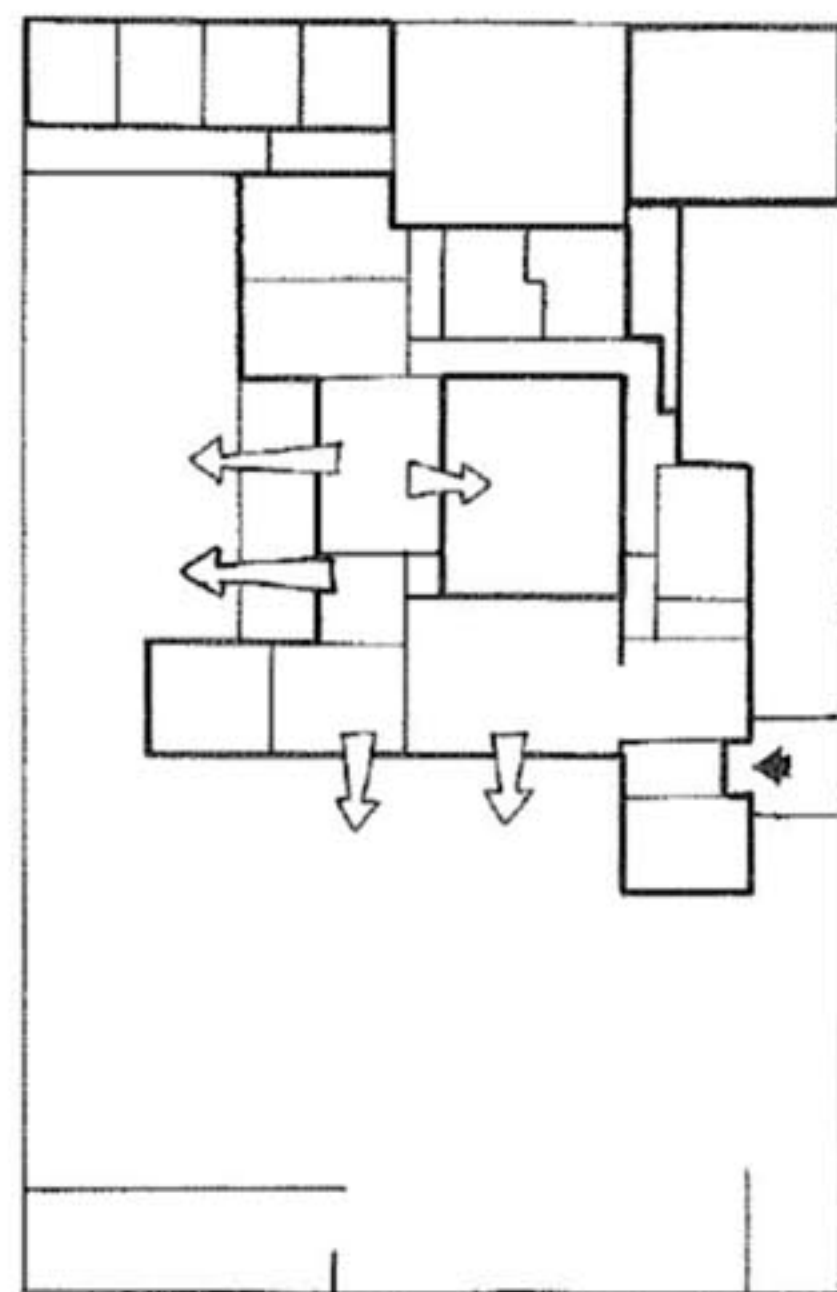
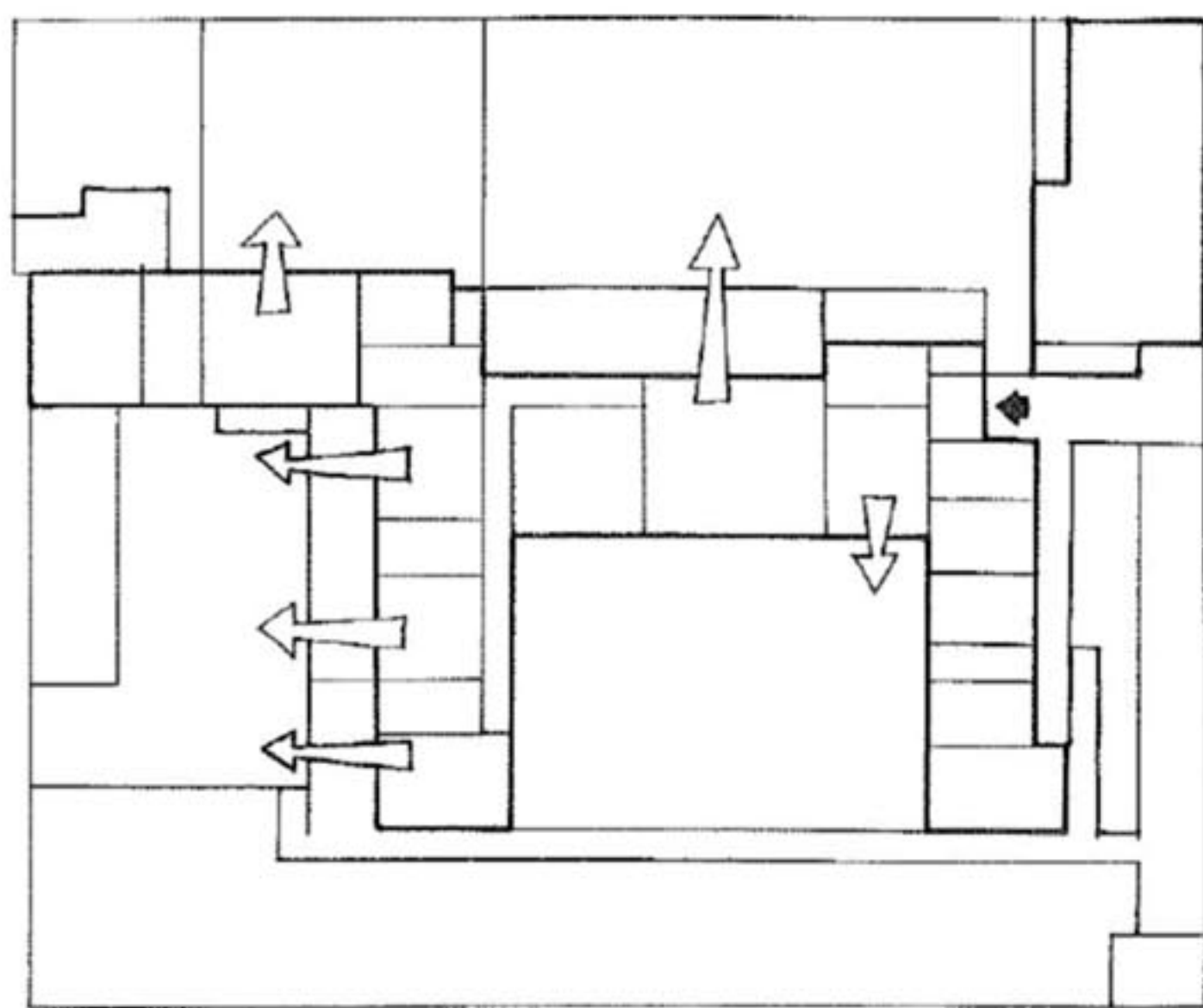

1

2

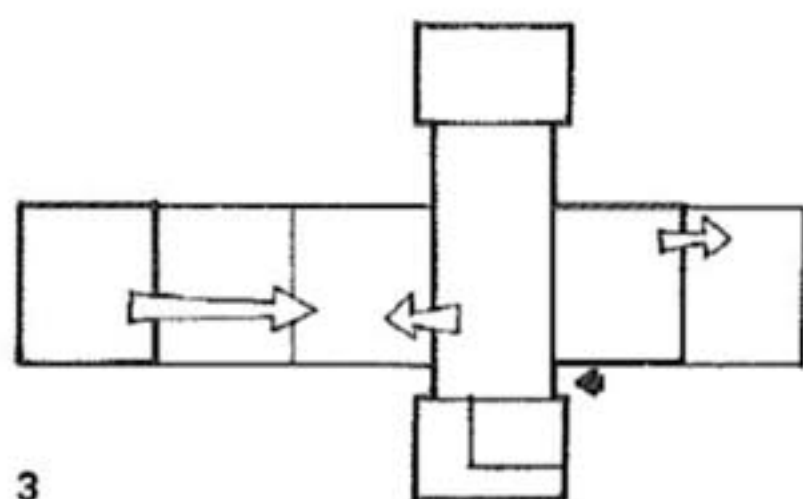

3

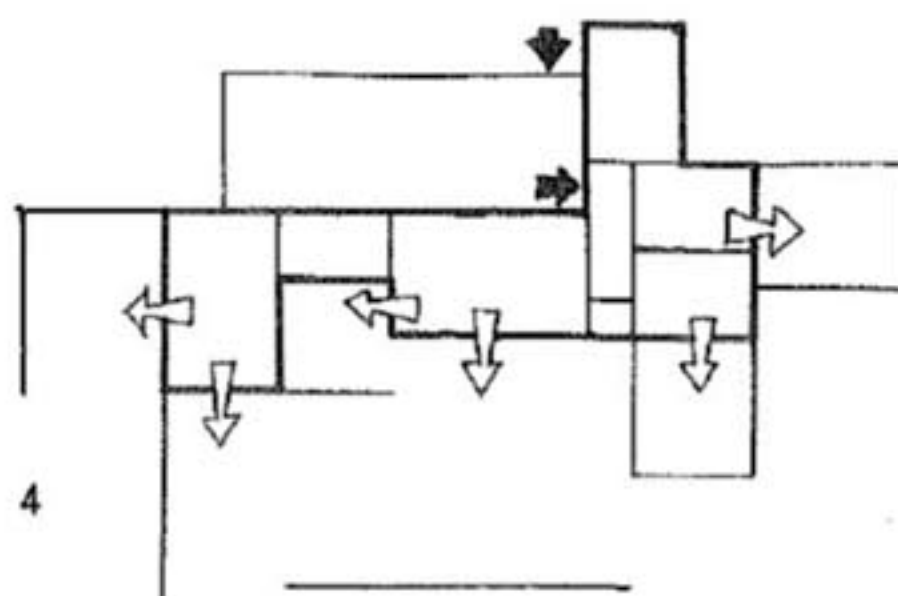

4

Interior / exterior spaces: schemata of functional relationships (black arrows mark the entrance; white ones indicate a direct relationship between the indoor and the outdoor rooms).

1. Arnstein house; 2. Frontini house; 3. 'Latin cross-shaped' house; 4. house for B&B at Amagansett

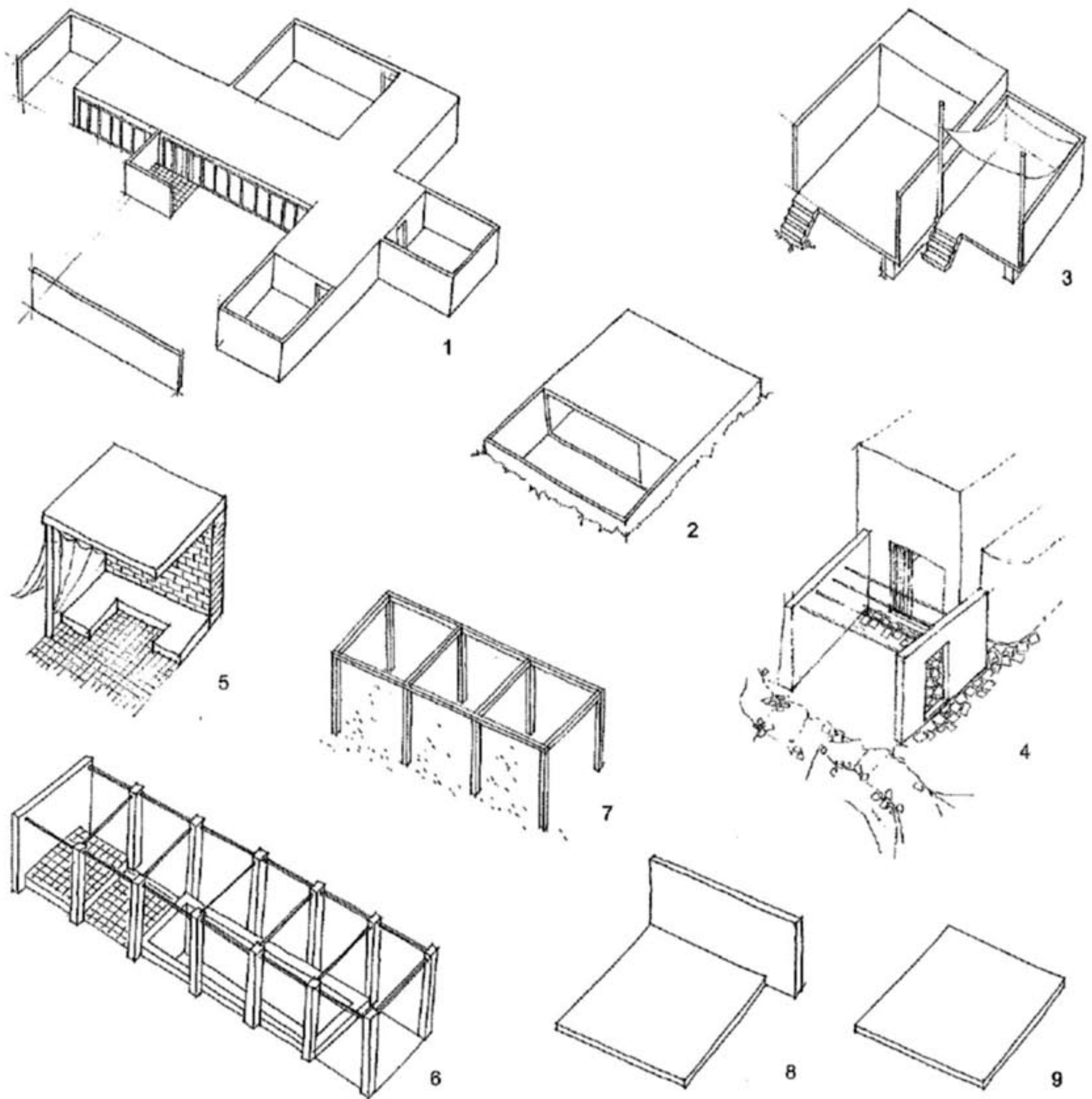

Rudofsky explores various options in the definition of rooms. Some are constituted of six faces, as is usual. Many have only five: in the atrium of the house on Procida, in the patios of the Arnstein house, and in the courtyard of the Frontini house, there is no ceiling. In the Oro house, La Casa, etc., one of the perimetral walls is missing. In the Villa Campanella, Rudofsky experiments with enclosures which, while delimited by an even lesser number of walls, still maintain, at least, the symbolic qualities of protection. In the Albergo San Michele and in the Frontini house, and in his own house at Amagansett, he defines certain open-air spaces by using just two perimetral walls. Some open-air pavilions have just a ceiling and one wall. In the Nivola and Carmel garden-houses there are areas that still maintain the properties of a room while being delimited by an almost immaterial lattice of very light pergolas. Platforms, commonly used in traditional Japanese architecture, represent the final reduction of the container to a single plane, but without losing the characteristics of a space for living.

Interior / exterior spaces: various degrees of definition of the spatial envelope.

1. House for B&B at Amagansett; 2. and 3. Yale Center for Environmental Studies; 4. Hotel San Michele (with Gio Ponti); 5. house for Berta Doctor on Procida; 6. La Casa; 7. and 8. Nivola house-garden; 9. Carmel garden-house

The Room

See p. 128 ff.

See picture at p. 159

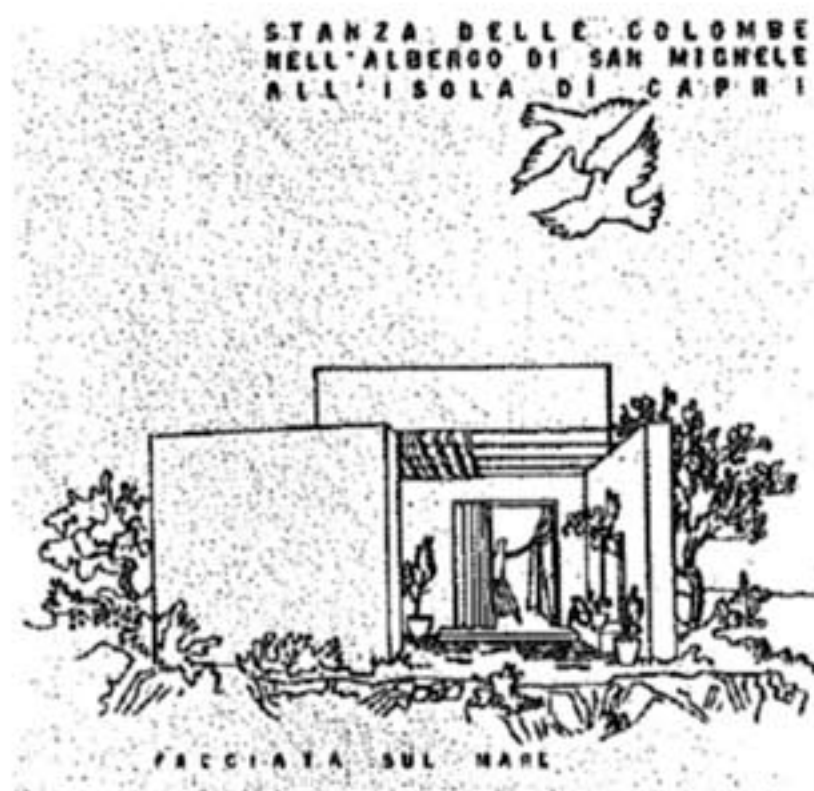

Gio Ponti. Seawards (east) elevation of the Room of the Doves at the Hotel San Michele (designed by Ponti and Rudofsky), ca. 1938. The hotel room is doubled by a patio, shaded by a cloth canopy, whose walled enclosure is interrupted to let the inhabitant enjoy the seascape.

See Catalogue no. 32 (p. 279) and no. 65 (p. 306)

If architecture's purpose is to give meaning to space, the room is, for Rudofsky, the fundamental architectural entity which brings measure to human habitation. It would be useful to read his theoretical works and his designs in the light of Gestalt hypotheses and the works of authors such as Christopher Alexander and Thomas Thiis-Evensen, who have explored the psychological value of space.⁷⁰

For Rudofsky, the open-air room enclosed by walls and lacking a ceiling symbolizes the entire idea of the house — to the point where, in a drawing published in *Domus* in 1938 and subsequently re-used as a cover for *Interiors* in 1946, he shows walls surrounding a room with a grass floor, containing a piano, a cot, two chairs next to a festively set little table, and a tree. The patio or garden enclosed by walls is, for him, the physical and symbolic place where the sacredness of the private sphere is concentrated.⁷¹

Aalto had drawn attention to Fra Angelico's *Annunciation* as the ideal example of the act of "entering a room." The trinity of *man, room and garden* shown in the picture makes it an unattainable ideal image of the home... The garden wall is the real external wall of the home."⁷² Rudofsky agrees, except that he does not think such a vision unattainable. In fact, if one were to reverse the American habit of building a single-family dwelling in the middle of the lot with no surrounding walls (a way of wasting a good deal of land without obtaining any intimate, really usable space),⁷³ it would be possible to build, even on urban lots, rooms open to the sky and offering "immeasurable immaterial values."⁷⁴

His models are the "rooms without ceilings of antiquity," "perfect examples of how a diminutive and apparently negligible quantity of land can, with some ingenuity, be transformed into an oasis of delight. These gardens were an essential part of the house... They were true outdoor living rooms, and invariably regarded as such by their inhabitants."⁷⁵ In his opinion, the signs left by man upon nature touch the heart more than grand open landscapes, which cannot offer an intimate experience.⁷⁶ Only in a *hortus conclusus* is it possible to enjoy contact with natural elements (sun, light, air, and perhaps water) while remaining in a private place. Plant life is an important but not indispensable element; what is essential is "an absence of disorder."⁷⁷

As in the Pompeian *domus*, in the Arnstein house and the house in Andalusia the entire lot is a dwelling, in a play of inhabitable and humanized (i.e., artificial) rooms having various degrees of openness and

70 Ernő Goldfinger, "The Sensation of Space", *The Architectural Review*, November 1941, p. 129-131; Rudolf Arnheim, *Art and visual perception. A psychology of the creative eye*, Berkeley-Los Angeles: University of California Press, 1954; Id., *The Dynamics of Architectural Form*, Berkeley-Los Angeles-London: University of California Press, 1977; Thomas Thiis-Evensen, *Archetypes in Architecture*, Oslo: Norwegian University Press, 1987.

71 BR86.2, p. 5. The concept had already been expressed by John Ruskin (*The Two Paths*, New York: Dutton, 1907), of whom Rudofsky was a passionate reader.

72 Göran Schildt, *Alvar Aalto. The Early Years*, New York: Rizzoli New York, 1984, p. 215-216.

73 BPW, p. 157.

74 BR86.2, p. 5.

75 BPW, p. 159.

76 TPB, p. 256.

77 BPW, p. 160.

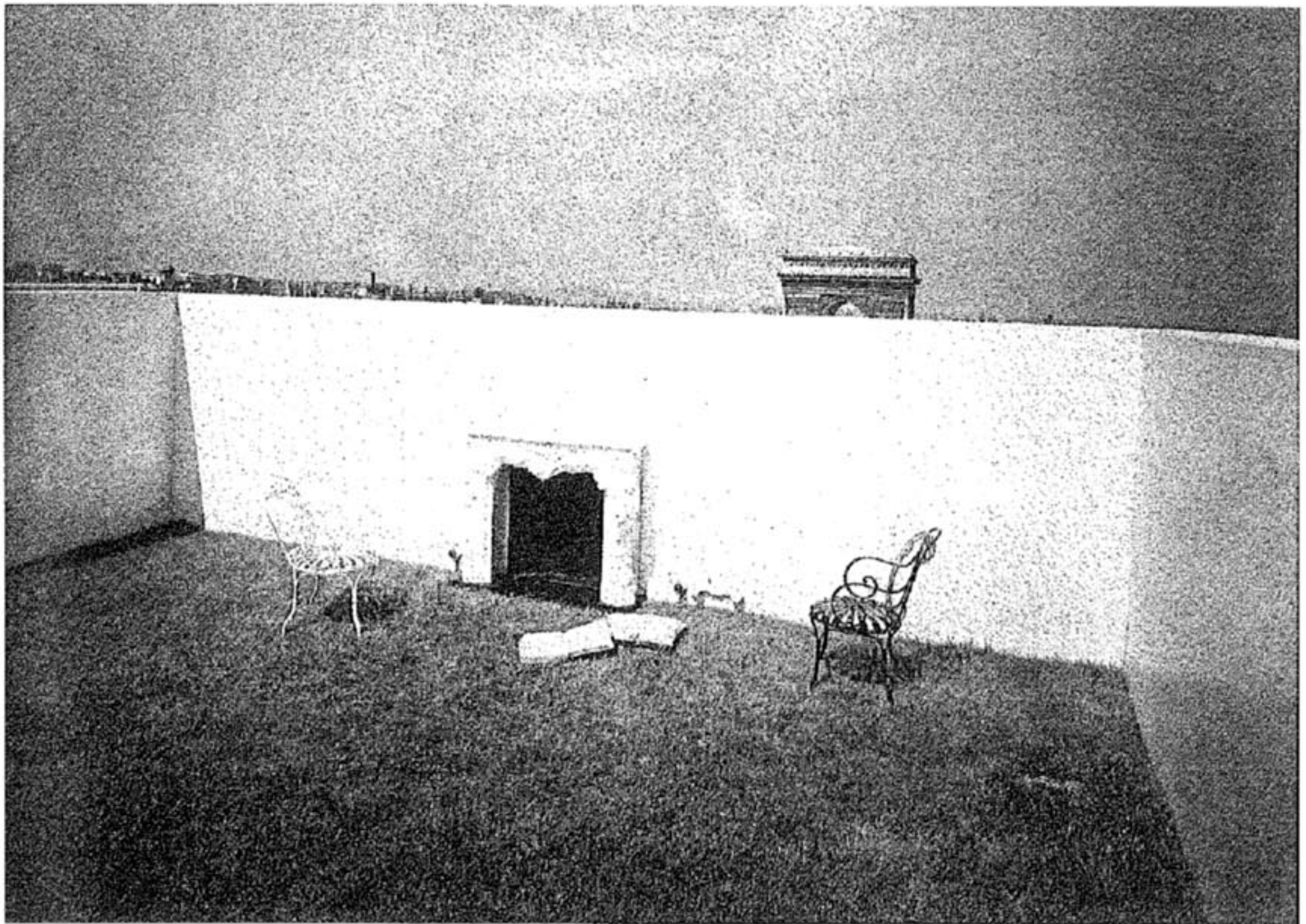

protection, although the covered area, in roofed buildings, amounts to less than half of the whole. (Where the entire available surface is built up, the open-air rooms are "cut out" from the existing volume, as in the office/pied-à-terre for John B. Salterini.)

Rudofsky — even though he employed them in his Brazilian houses — criticizes the use of glass walls, accusing them of having "alienated the garden. Even the 'picture window'...has contributed to the estrangement between indoors and outdoors; the garden has become a spectator garden."⁷⁸ There immediately comes to mind the comparison with the window as a cinematic screen in Neutra's houses in California; the privileged location permits a panoramic vista, but the garden can't be experienced as an intimate room.⁷⁹

The open-air room is found in many of Rudofsky's works, and was the unifying element that he himself chose for the only retrospective thus far staged of his work.⁸⁰ The Nivola house-garden offered him the occasion for writing one of his finest texts. Rudofsky devotes to the exploration (and promotion) of this theme one of his most densely argued and extensive articles.

But as early as the period of his collaboration with the magazine

The "outdoor room" on the top of Beistegui apartment, designed by Le Corbusier, ca. 1931. The terrace is paved with grass and enclosed by walls; a symbolic, non-functional fireplace strengthens the impression of an interior. The height of the walls lets them select from the Parisian cityscape just a few elements (the Arc de Triomphe, the Eiffel Tower), as in an abstract composition. Le Corbusier developed this celebrated example above all by arranging creative solutions for the roofs of multi-storied apartment blocks, such as the Unités d'Habitation.

See Catalogue no. 49 (p. 292) and *The Bread of Architecture*, p. 196

See Notes on Patios, p. 192

78 BPW, p.159.

79 Cf. Giovanni Klaus Koenig, *Architettura e comunicazione*, Firenze: Libreria Editrice Fiorentina, 1974², p. 327 and 382.

80 BR86.2.

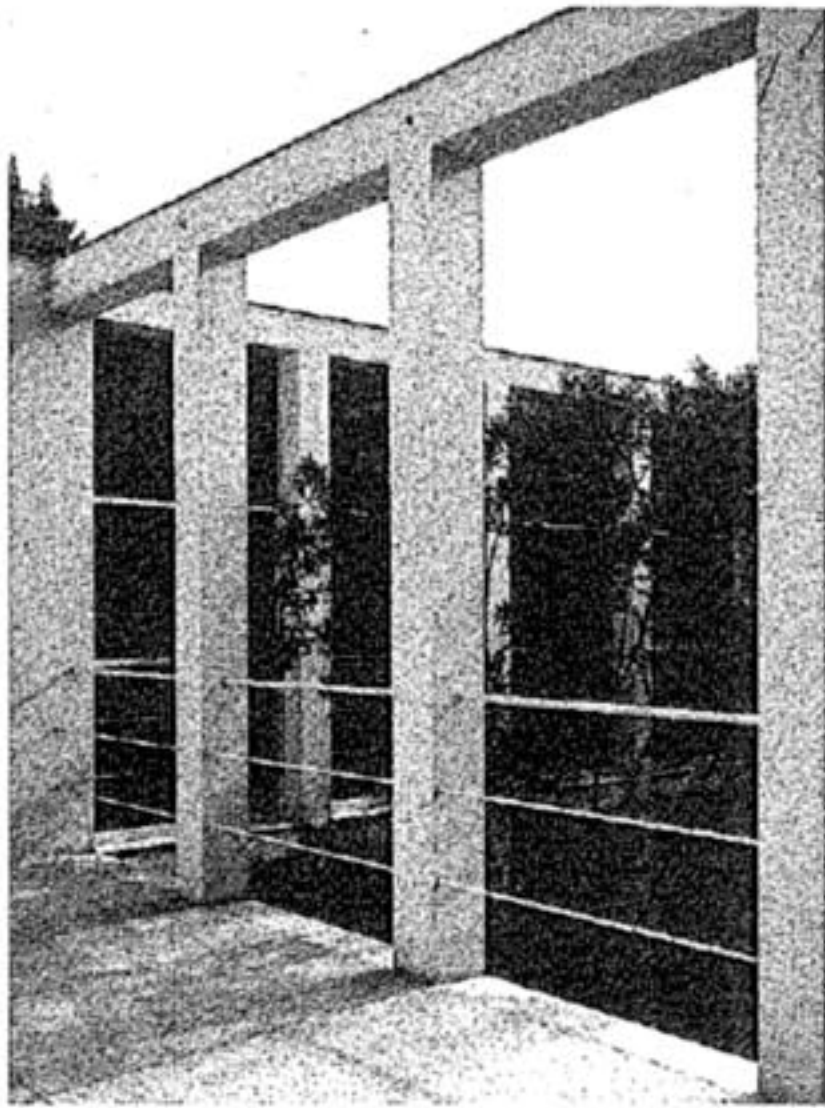

G. E. Kidder Smith. View from the Frontini house's second-floor terrace into its patio, 1942.

Grant Mudford. Rudolph Schindler, Schindler/Chace house in Kings Road, West Hollywood. Evening view of patio to Rudolph and Pauline Schindler, ca. 2000.

Domus (1938), he published aphorisms on the open-air room⁸¹ and examples of houses with patios drawn from Guido Harbers's book *Der Wohngarten*.⁸² It is possible that Rudofsky's exploration was influenced by the experimental house am Horn, which he had visited at the Bauhaus show in Weimar in 1923. The house was designed by Georg Muche with the collaboration of Walter Gropius. (The central space, which served as a living room, was covered by a roof and illuminated by clerestory windows.) He may also have been influenced by Oiva Kallio's Oivala Atrium House in Helsinki (1925), published by Harbers, which was similar but built of wood. Both houses represent a (not very) modernized evolution of the Roman-Italic house with an atrium, and can claim to be direct ancestors of the first two houses with a central patio designed by Rudofsky: the ones for Capri (1932) and Procida (1935).

Duncan Macintosh has systematically reconstructed the history of this building type. He maintains that Harwell H. Harris, in the Pauline Lowe House (1934), was the first architect to assign every bedroom its own courtyard for sleeping out of doors.⁸³ Shortly afterwards came Wright's Wingspread (1937), in which every zone of the house has a corresponding outdoor space. But Schindler, in his own house in West Hollywood (1921–22), had already created, with clarity and care, cozy outdoor living rooms, each with its own fireplace.⁸⁴

It is not certain that Rudofsky knew all these examples when he designed his Brazilian houses, the ground plans of which are among the best

81 BR38.7; BR38.14 (here at p. 183).

82 Guido Harbers, *Der Wohngarten: Seine Raum- und Bauelemente*, München: Callwey, 1933.

83 Duncan Macintosh, *The Modern Courtyard House*, London: Architectural Association/Lund Humphries, 1973, p. 12–14.

84 See Reyner Banham, *Los Angeles. The Architecture of Four Ecologies*, Harmondsworth: Allen Lane-The Penguin Press, 1971; Elizabeth A. T. Smith, Michael Darling (organized by), *The Architecture of R. M. Schindler*, Los Angeles: The Museum of Contemporary Art, 2001.

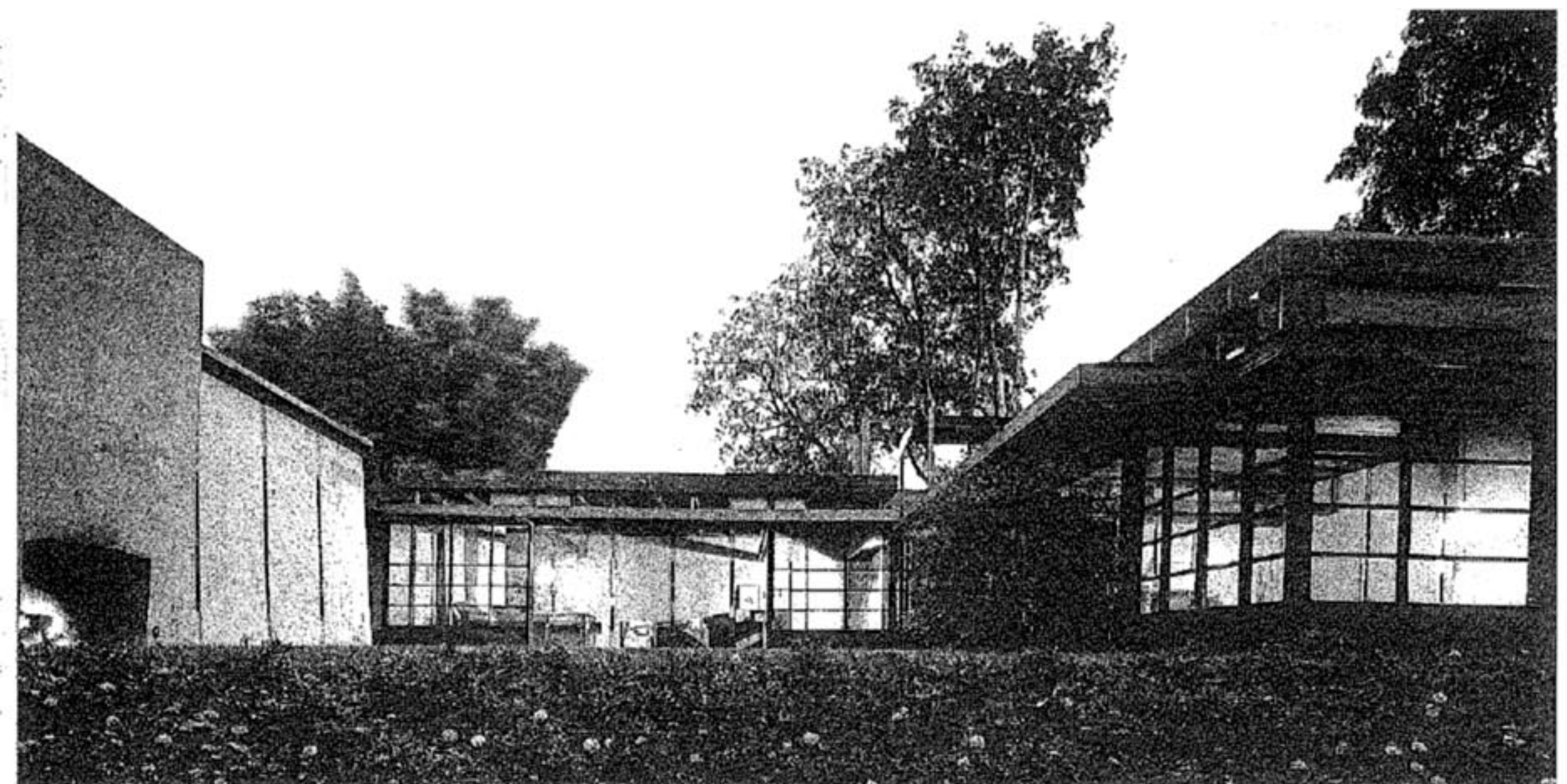

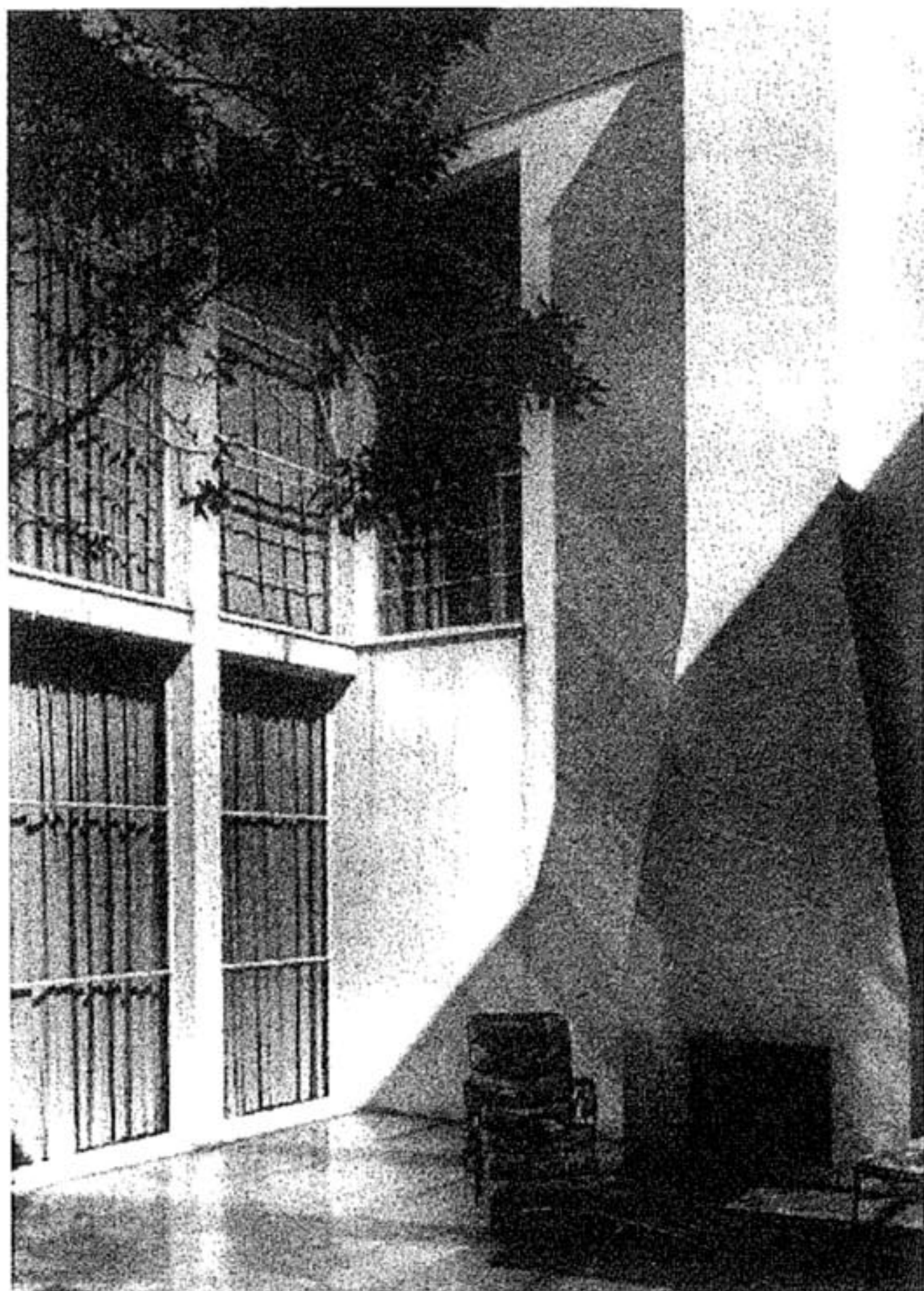

Peter C. Scheier. The courtyard of the Frontini house, ca. 1941-42.

distributed of their type.⁸⁵ It seems to me sufficient to note that there was, in that period, a convergence among several architects around the theme of the patio house and, more generally, the blurring of the distinction between indoor and outdoor spaces in the single-family dwelling.⁸⁶ In his modern use of the courtyard, Rudofsky is likewise up-to-date with a contemporary movement. The originality of his contribution resides in his theoretical apparatus and insistence that the house is incomplete without an open-air inhabitable space (room).⁸⁷ He maintains that a life lived entirely indoors, while biologically possible, means deprivation of "something of the essence of being human."⁸⁸

85 AR43.5, p. 19.

86 Tim Benton, "Recherche patiente", Jacques Lucan (ed.), *Le Corbusier. Une Encyclopédie*, Paris: 1987.

87 BPW, p. 162.

88 BPW, p. 151.

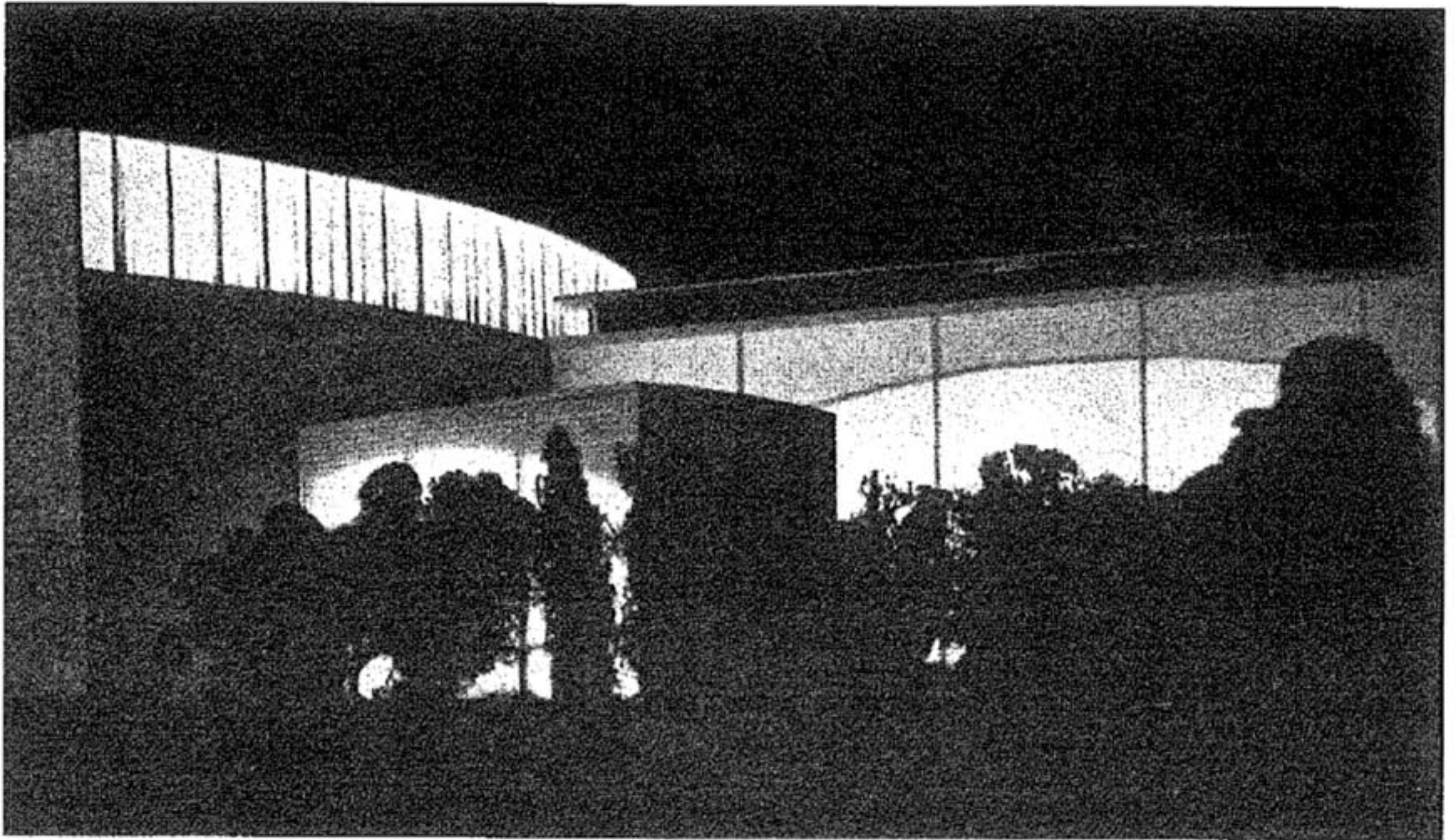

Bernhard Rudofsky (?). Night view of the Rome Auditorium's model (design by L. Cosenza and B. Rudofsky), with the panoramic porticoed promenade on the upper floor, 1934–35.

Even this large public building benefits by an abundance of outdoor areas, located not only in the surrounding gardens but also on the roof terraces as well as in the garden-level open porticoes.

During the fifties and sixties structural anthropology, sociology, and historiography fruitfully intersected. Research now took in material culture, collective symbols, objects for use, everyday activities, popular culture. Working in many cases independently of one another, several authors were revolutionizing the historical sciences with their studies of great human and collective themes. As Josep Maria Montaner has noted, this evolution of the human sciences was not without consequences for postwar architecture.⁸⁹

Rudofsky's explorations of the themes of the house and clothing, which he had been carrying on at least since the thirties, may be compared with this cultural climate; but their point of departure is the broad curiosity of Ruskin, Morris, Loos regarding the concrete aspects of existence. This research produces deeply coherent results. Rudofsky's shows — from *Are Clothes Modern?* (New York, 1944) to the recapitulatory *Now I Lay Me Down to Eat* (New York, 1980) and *Sparta/Sybaris* (Vienna, 1987) — and his prolific production of publications are born of the selfsame interest in material life, even if, because of the barriers of habit or disciplines, they are classified heterogeneously, and are read and followed by different publics: "Mr. Rudofsky has spent a lifetime analyzing and challenging all the conventional and received wisdom about the arts of living and design... [He] has never ceased asking disturbing and illuminating questions about the logic of the ways in which we conduct our lives, and the design of the objects we use for our daily needs."⁹⁰

The origins of Rudofsky's ideas may be traced to "that culture of the reform of life (*Lebensreform*) that characterized vast sectors of German society at the start of the century," represented by Arnold

On the Art of Living (A Natural Philosophy of Living)

89 AR93.1.

90 AR81.3.

See p. 175

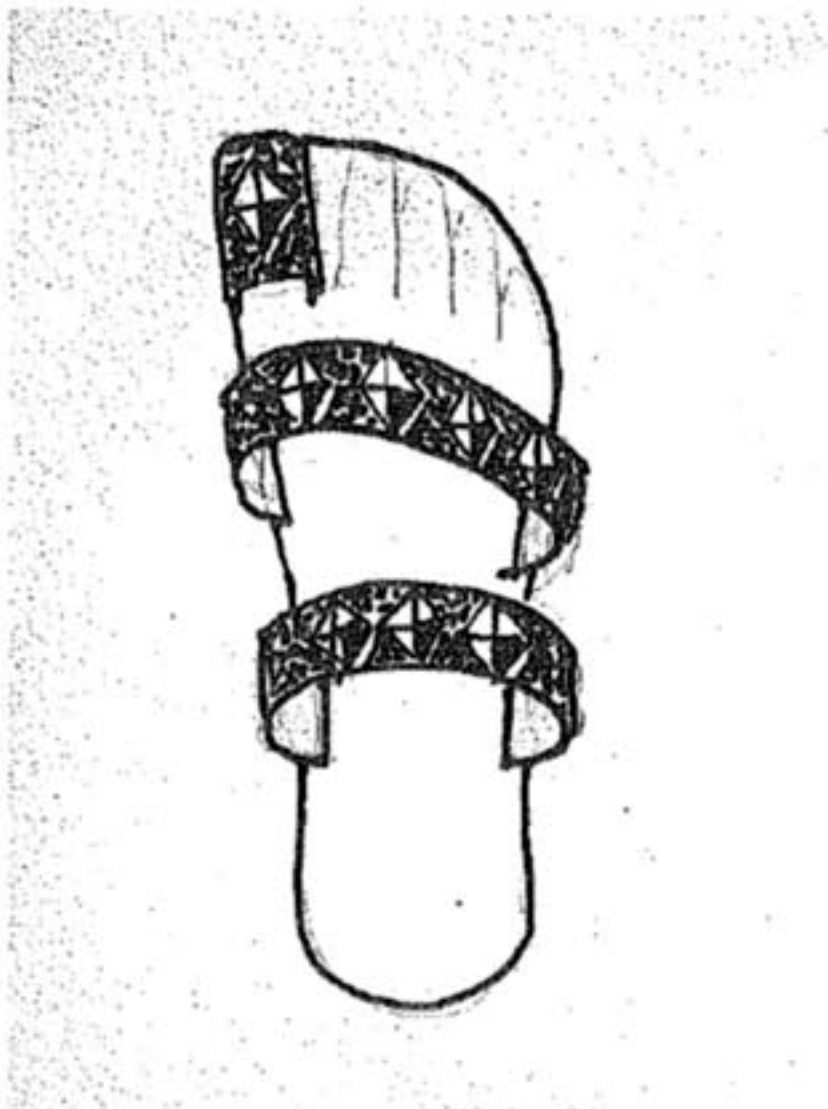

Bernard Rudofsky. Sandal design for the Golden Eye project, 1985 (?). This unproduced style features three embroidered bands with glass jewels or metal plates applied. Healthy footwear is one of the basic principles of the reform of the way of life encouraged by Rudofsky.

Rikli,⁹¹ E. Lahmann,⁹² Gustav Jäger,⁹³ Hans Weisen⁹⁴ — a culture that had considered many aspects of material life, from clothing to physical exercise, from food to domestic settings and activities. In the twenties and thirties, it had become common property. It is likely that Rudofsky had met some of its exponents in Vienna, and had come into more direct contact with it during the period when he lived in Berlin; it cannot be ruled out that he absorbed some of Steiner's ideas.⁹⁵

It is probable that Le Corbusier himself derived from the Reform movement the "Manual of Habitation" contained in his *Vers une architecture*, in which he states that "we deserve compassion because we live in unworthy houses that ruin our health and our morale."⁹⁶

The process of rationalization and stylistic simplification, the elimination of ornaments, the pursuit of a practicality deriving from an analysis of function — an ongoing process in the architectural discipline during the first thirty years of the twentieth century — was frequently linked to what was happening in the relationship to the body and in clothing. Rudofsky's text *What's needed is not a new way of building...* bears an epigraph from Morris: "How can this people expect to have good architecture when they wear such clothes?" Loos frequently deals with clothing; he speaks of fashion, footwear, feminine ornament, tattoos. Frank holds forth on the relationship between nudity, physical exercise, and clothing.⁹⁷ Not to speak of those German architects, such as May, Taut, and Gropius, whose appeal for light, air, and sun in architecture is associated with the fight against tuberculosis, the practice of sports, the return to physical culture and the nakedness of bodies; they too, in all probability, were nourished by concepts connected with the *Lebensreform*.

In almost all Rudofsky's declarations regarding comfort in domestic activities, but also the comfort of clothing, one may recognize statements by earlier writers. In many regards, his ideas are a reworking of those of others, rendered more eclectic by his exotic frame of reference and arranged into a coherent scheme.

Nonetheless, Rudofsky — unlike the architects cited above — dedicated a good part of his life to the propagation of these ideas, and did so in a particularly hostile country and historical period. (Today he would still have good reason to shoot his arrows, but many things have changed in the direction he pointed to.) His three most important shows, and at least five of his nine books, are specifically devoted to the art of living. In short, this is the theme that unifies the greater part of his work, the theme to which he dedicates much of his energy and on which he seeks interaction with a broad public.

Rudofsky works in the intermediate region of the full life, a terrain situated between the two extremes of materialistic oversimplification on

91 Siegfried Giedion (*Mechanization Takes Command*, New York: Oxford University Press, 1948, p. 671 ff.) spoke about Arnold Rikli's (1823–1906) "bath" or "atmospheric cure."

92 E. Lahmann, *Die Reform der Kleidung*, Stuttgart, 1903.

93 Gustav Jäger, *A Treatise on Health Culture*, New York, 1886.

94 Marco De Michelis, "La casa della riforma della vita", Georges Teyssot (ed.), *Il progetto domestico. La casa dell'uomo: archetipi e prototipi*, Milano: Triennale di Milano-Electa, 1986, p. 204. Cf. also Janos Frecot, "Reform-Haus", *Rogner's Magazin*, # 11–12, 1977, p. 110–113.

95 UHB, p. 183–189.

96 Le Corbusier, *Vers une architecture*, Paris: Crès, 1923.

97 Josef Frank, op. cit.



*Unknown photographer (Giorgio Casali?).
Room for listening to records in USA Pavilion
at Brussels Expo, designed by Rudofsky, 1958.
The room had a ceiling covered with 350 long-
playing record covers, and was furnished with
the famous Bertoja chairs. Unlike the case
here, in his last exhibition, Sparta/Sybaris,
Rudofsky proposed a "music room" in
which live music would be played.*

the one hand and the exaltation of spiritual values alone, to the detriment or negation of physical values on the other. He repeats that "[w]e have lost the art of living, the most important science of all." His constant appeal is for us to develop "a taste for dignified living."⁹⁸ With reference to the United States he declares: "We are a utilitarian society... We are not interested in living a graceful life... We want short cuts. We are not accustomed to the good life — we don't know what to do with leisure. The machine plays a big part in our lives — we even use it for killing time. For example we listen to a machine instead of making music. There is a general passivity in this country."⁹⁹

Like the physician Asclepiades of Bithynia, Rudofsky is more interested in identifying ways of living a healthy life than in studying pathological cases.¹⁰⁰ His mission is "education for a happy life,"¹⁰¹ in order to "affirm the [immemorial] charm of existence"¹⁰² and to reintegrate the "natural stimuli essential for many functions of...body and...mind"¹⁰³ of which modern man is deprived.

Disorientation and dispersion in the world can be combated by restoring a meaning, almost a certain sacredness, to everyday gestures. Rudofsky invites his public to evaluate attentively the consequences of the replacement of (manual) utensils with (electric) appliances: the difference lies not in the source of energy, but in the existential appropriation of work and its products.¹⁰⁴ The iteration of gestures confers dignity upon them, and this has nothing to do with economic wealth. The modest price of tea has not prevented certain cultures from developing highly refined rituals regarding its preparation and consumption.

However, it is not necessary to follow local tradition uncritically. The modern world makes available a vast repertory of opportunities among which it is possible to make conscious choices in accordance with individual preferences. Formulating the concrete problems of living for ourselves, critically and without prejudices, can help us to preserve, and even to enhance, our personal dignity, beyond social conventions and the conditioning of advertising.

The important thing is simplification: getting rid of everything which is not essential, which has no existential meaning, which does not really enhance the quality of life.

It is also important that we shed our thoroughly Judeo-Christian sense of guilt every time that we enact gestures of attention on our own behalf; we must not fear to confer a sensual value upon material life, nor to take advantage of the rites of the household and the body as occasions for conviviality with our intimates.

Rudofsky devotes a lot of energy to fighting the equation "moral=uncomfortable." He strives to affirm the value of the pleasure of food, of a relaxing bath, of whatever seems sinful because it goes beyond what is necessary. He challenges the association between the "seriousness" and the "moral" rigidity of clothing and chairs; he uses the term *sartoriasis*, coined by friend Serge Chermayeff, and defined as "the enjoyment of discomfort."

98 BPW, p. 159.

99 AR63.3.

100 BPW, p. 72.

101 AR49.2, p. 1.

102 Rudofsky closes SFP (p. 342) by quoting Jane Addams, winner of the Nobel Peace Prize in 1931.

103 TPB, p. 66.

104 BPW, p. 170.

He also shows how behavior and comfort are often in irreconcilable conflict, leading to absurd situations that interfere with the pleasantness of everyday life. Rudofsky is convinced that our judgments on food, bedroom fixtures, ways of sitting, or the clothing we wear are enslaved to ethnocentric prejudice. The unease produced by the perception that something is not entirely satisfactory is far outstripped by the feeling that we are doing things right, that our "way of life" is superior to all others.¹⁰⁵ The cultural battle for the art of living was not an extravagance. Rudofsky proposed to museums and universities that they institute a chair or a department dedicated to it; the suggestion met with a chilly reception. Not even the underlying assumptions of his investigations were always shared: "When I proposed my exhibition *Are Clothes Modern?* at New York's Museum of Modern Art, its director [Alfred H. Barr, Jr.] confessed that he was completely oblivious of the clothes he wore. He saw no connection between art and everyday life; no relationship between intellectual pursuits and the conduct of one's life. The curator of design at the same museum [Edgar Kaufmann, Jr.], who dignified pots and pans by showing them in his memorable *Good Design* exhibition, assured me that he could not care less what he was eating. To his mind a kitchen pot was an objet d'art; its use for preparing food was purely incidental."¹⁰⁶

Rudofsky criticized both the difficulty of accepting the body in its nakedness without moralizing and "man's unwillingness to accept the anatomic form of the human body, as satisfactory and definite."¹⁰⁷

The first aspect concerns the moral question and the hypocrisy of modesty. To the Judeo-Christian mentality, the nakedness of the body is inextricably connected with sin; while covering oneself — and obliging others to do so — is linked with the spread of false modesty. Some writers, including Giorgio Triani, have described the unbridgeable gap that separated nineteenth-century Westerners, above all those of elevated class, from their own bodies.¹⁰⁸

This rejection of the body started to go into crisis with the discovery of the South, open-air life, sports, hygiene, and the installation of plumbing; in the 1880s "there began to be a strong suspicion that those who had resisted the lure of the city or who worked in healthful climates often wound up living — even in their absolute simplicity — better than rich city-dwellers and distinguished people." Thus began the long process of

Unsatisfactory Relationships

105 BPW, p. 43.

106 Bernard Rudofsky, unidentified unpublished lecture, 1980.

107 Aborted subtitle for UHB.

More or less recent texts on the subject include: Paul Ableman, *Anatomy of Nakedness*, London: Orbis Publishing, 1982; Ruth Barnes, Joanne B. Eicher (eds.), *Dress and Gender: Making and Meaning in Cultural Contexts*, New York-Oxford, 1992; Jonathan Benthall, Ted Polhemus, *The Body as a Medium of Expression*, London: Allen Lane, 1975; Ernesta Cernulli, *Vestirsi, spogliarsi, travestirsi: come, quando, perché*, Palermo: Sellerio, 1981; Stéphanie Heuze (ed.), *Changer le corps?*, Paris: Editions La Musardine, 2000; Ted Polhemus, Lynn Procter, *Fashion and Anti-Fashion: An Anthropology of Clothing and Adornment*, London: Thames and Hudson, 1978; Ted Polhemus, Housk Randall, *The Customized Body*, London-New York, 1996; Julian Robinson, *Body Packaging: A Guide to Human Sexual Display*, Los Angeles: Elysium Growth, 1988.

108 Giorgio Triani, *Pelle di luna Pelle di sole. Nascita e storia della civiltà balneare 1700-1946*, Venezia: Marsilio, 1988.

the "self-affirmation of the body"¹⁰⁹ which, despite some steps backward, continues to this day. The spread and acceptance of clothing that increasingly displays the body's shapes rather than hiding them accompanied this care for the body and its hygiene.

Rudofsky agrees with Montesquieu and Taut,¹¹⁰ among others, in postulating a direct relationship between the care devoted to the material side of existence and the quality of intellectual results, between refinement of the senses and artistic refinement: "[A]lthough we disapprove of the ancients' way of life, we have nothing but admiration for their aesthetic standards," which are none other than "the consequence of a happy balance between mind and body."¹¹¹ It is no accident that "the nations who achieved a body culture [and a sense of touch] through a highly developed bathing routine happen to be the very same who produced intelligently conceived forms of dress."¹¹² Rudofsky is a supporter of cutaneous and muscular eroticism, of the pleasure of naked skin exposed to air and sun, but also of the sensorial pleasure of the heat generated by the warm water of the bath.

Like the Northern European theorists of nudism and like Flügel, he states that a greater social familiarity with nudity is matched by a diminution of immorality and of uncontrolled sexual impulses. Nudity must be accepted, at least in those places where it is the most obvious and appropriate form of "dress," for example on the beach: "[T]he idea that white men has to wear a special suit while bathing, reflects his dubious ethics."¹¹³

No culture seems immune to the other aspect of human dissatisfaction with the body. There exists a general tendency to modify it, to mark it with the signs of membership in a group, even deforming it. This tendency is not restricted to "primitive" human groups.

The failure to recognize these customs derives, in general, from membership in the culture that defines them and takes them for granted. The deformation most systematically practiced by Westerners is that of

Soichi Sunami. "Body Idols:" The four plaster figures, designed by Rudofsky and executed by Costantino Nivola, show a woman's body as it had to appear to fit the clothes of four fashion periods (from Bernard Rudofsky's Are Clothes Modern?), ca. 1944.

From left to right: A woman of 1875 whose figure literally conforms to her bustle. The dowager type with the shelf-like overhanging mono-bosom of 1904. The vase-like figure of 1913 which seemed to have one single leg under the hobble skirt. The concave flapper form of the nineteen-twenties.

109 Georges Vigarello, *Le propre et le sale. L'hygiène du corps depuis le Moyen Age*, Paris: Seuil, 1985.

110 Bruno Taut, *Houses and People of Japan*, op. cit., p. 19.

111 BPW, p. 121.

112 UHB, p. 207.

113 ACM, p. 34.

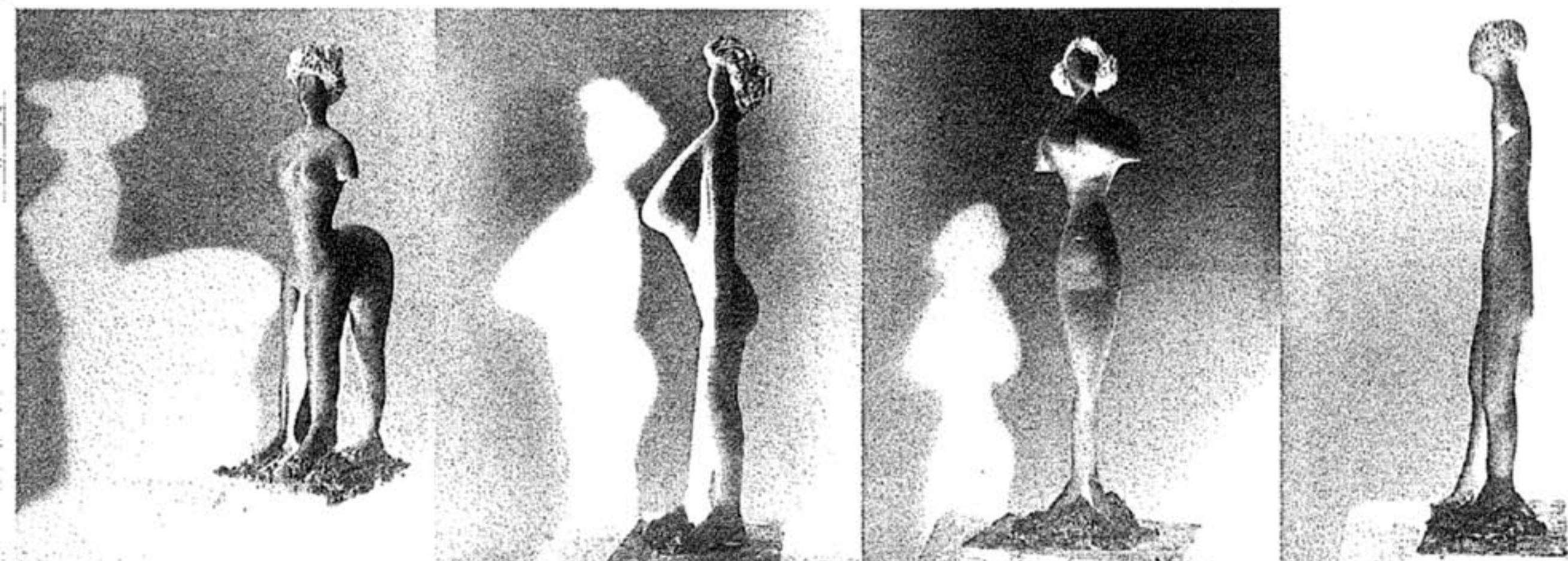

the foot, the result of the use of shoes. Loos had already spoken of "immoral" shoes."¹¹⁴

The inability to accept the body as it is is also expressed in other ways, including the constant effort to adapt it to a model — one which is, moreover, constantly changing, along with every new fashion. Thus was born one of Rudofsky's most striking titles: *The Unfashionable Human Body*. Rudofsky agrees with Loos in his contempt (but laced, in his case, with irony) for "ladies' fashion...an atrocious chapter in the history of civilization;"¹¹⁵ and he yearns for clothing that will be beyond fashion, suited to the body and capable of following its movements, clothing healthful and "natural," in harmony with the Creator's intentions.¹¹⁶

Rudofsky had taken an interest in clothing ever since his youthful years; but, except for an article in *Domus*, this concern bore no fruit prior to the show *Are Clothes Modern?*¹¹⁷

The intention is a critical revisitation of clothing, its motivations and constructive principles, with the goal of identifying solutions more appropriate to the period, with its activities and ethics, and to the human body itself; Rudofsky ends up by demonstrating the incompatibility between the clothes we wear and our bodies.

He accepts the thesis, prevalent among anthropologists and psychologists, that the original reasons for clothing involve symbolism and sexual attractiveness. He is therefore aware that clothing produces "delights that outweigh discomfort and organic disorders,"¹¹⁸ and that it "fits a person mentally rather than physically."¹¹⁹ He sees that we are, as a result, disposed to accept that a garment may be unsuitable from the practical standpoint, failing to answer, first and foremost, requirements for comfort, practical usefulness, effectiveness in protecting us from cold and rain. Despite its failure to meet these needs and even its harmfulness to health (Rudofsky says that "Today's shoe boxes ought to carry the warning: WEARING OUR SHOES MAY BE DANGEROUS TO YOUR HEALTH"),¹²⁰ a garment may be worn and admired for other reasons.

And yet, convinced that psychophysical equilibrium and happiness cannot exist without the abandonment of clothes that impede movement, Rudofsky sides with those who propose clothing's rationalization. It has been noted that "poor Bernard had made the mistake of applying reason to an area of human activity [clothing] that is nearly always deliberately, exuberantly, inexpungibly unreasonable."¹²¹

See Fashion: Inhuman Garment, p. 180

114 Adolf Loos, "Die Schuhmacher", *Ins Leere gesprochen*, Paris: Crès, 1921 (English translation: Adolf Loos, *Ornament and Crime, Selected Essays*, Riverside CA: Ariadne Press, 1996, p. 103).

115 Adolf Loos, "Damenmode", *ibidem* (English translation: Adolf Loos, *Ornament and Crime*, cit., p. 106)

116 See also BR71.2.

117 Among Rudofsky's early readings on the subject, further than the already cited books, are worth mentioning: Ada G. Woolson, *Dress, Health and Beauty*, 1882; Paul Schultze-Naumburg, *Die Kultur des weiblichen Körpers als Grundlage der Frauenkleidung*, Leipzig, 1901; Max von Boehn, *Bekleidungskunst und Mode*, München, Delphin-Verl., 1918; Elizabeth R. Hurlock, *The Psychology of Dress: An Analysis of Fashion and Its Motive*, New York: Ronald, 1929; Marcel Mauss, *Les techniques du corps*, 1934; Havelock Ellis, *Studies in the Psychology of Sex*, New York: Random House, 1936; Hilaire Hiller, *Costume and Ideologies*, New York, 1939.

118 UHB, p. 12.

119 UHB, p. 200.

120 Bernard Rudofsky, probably unpublished text for the *Golden Eye* project.

121 AR90.3, p. 48.

Unknown photographer (Barbara Sutro?).

The stigma of our civilization is the deformed foot (from Bernard Rudofsky's *Are Clothes Modern?*), ca. 1944.

Simply by juxtaposing a man's shoe, a cobbler's wooden last, and two plaster models — one representing the hypothetical foot that might wear the shoe and the other one a real foot deformed by adapting to it —, Rudofsky offers an exemplary demonstration that what we wear is not conceived for the shape of the human body.

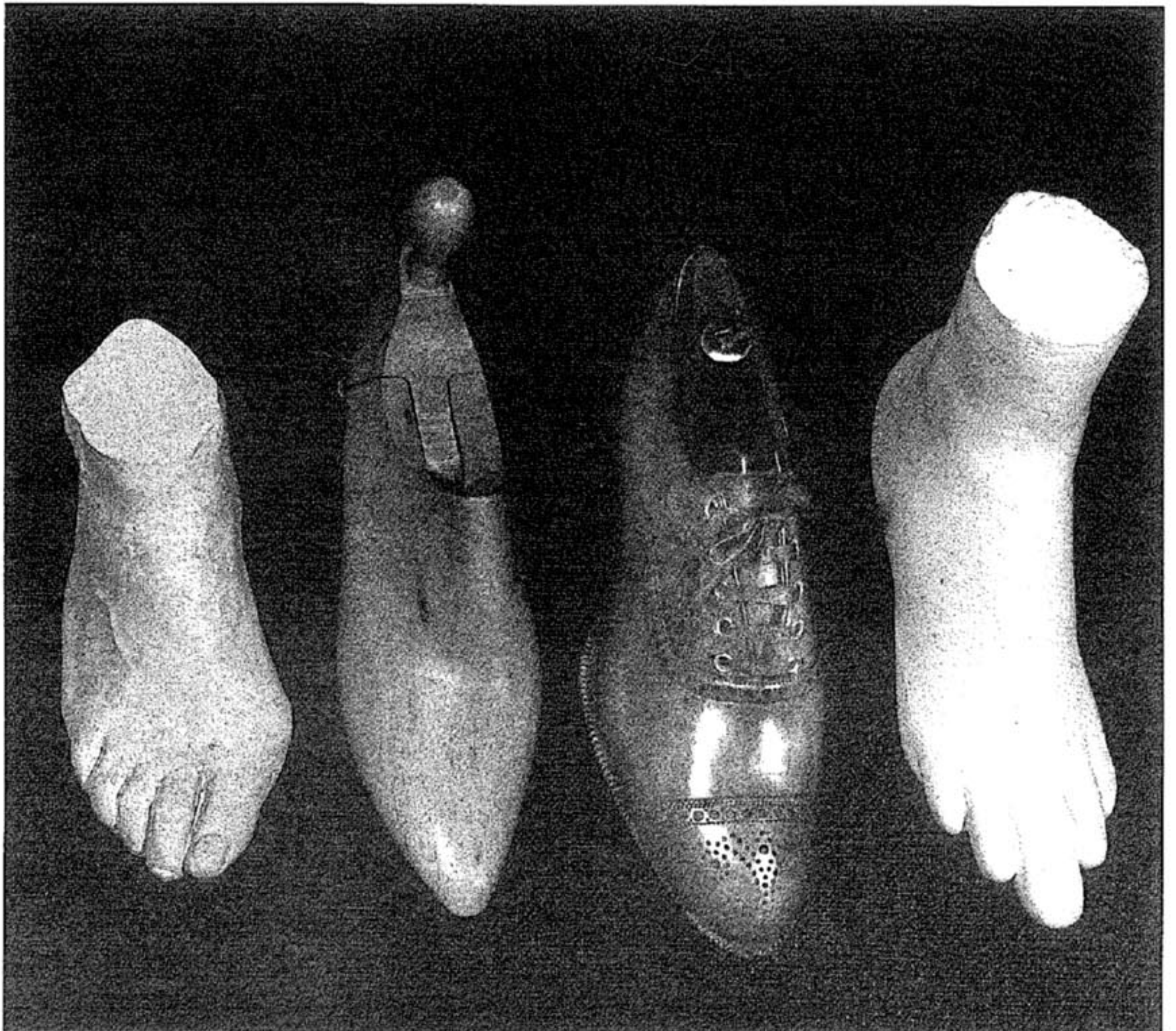

Rudofsky's footwear is "not a designer's deceit but part of [his] architectural credo."¹²²

Linda O'Keefe has asserted, "The early brogue, the original clog, the Native American moccasin and the simple Egyptian sandal are the only styles of footwear we actually need. The rest are shoemakers' dreams and the fulfillment of women's (and men's) fantasies... When it comes to shoes, practicality and comfort are beside the point... Shoes can be witty and drop-dead gorgeous, but not very comfortable. All too often they don't fit like a glove or conform to the foot's natural contours. But that doesn't really matter."¹²³ Rudofsky is perfectly aware of this state of affairs but, in his opinion, *it does really matter*. He rejects closed shoes (perhaps, in part, because the regions he considers inhabitable have a warm climate), shoes that deform the foot, those that force it into unnatural positions. High heels entail a series of postural and anatomical problems that can

122 Letter from Bernard Rudofsky to Zette Emmons, 22 May 1985.

123 Linda O'Keefe, *Shoes. A Celebration of Pumps, Sandals, Slippers and More*, Köln: Könemann, 1996, p. 240, p. 15-16.

Bernard Rudofsky. Studies for sandals, date uncertain (1930s-40s?).

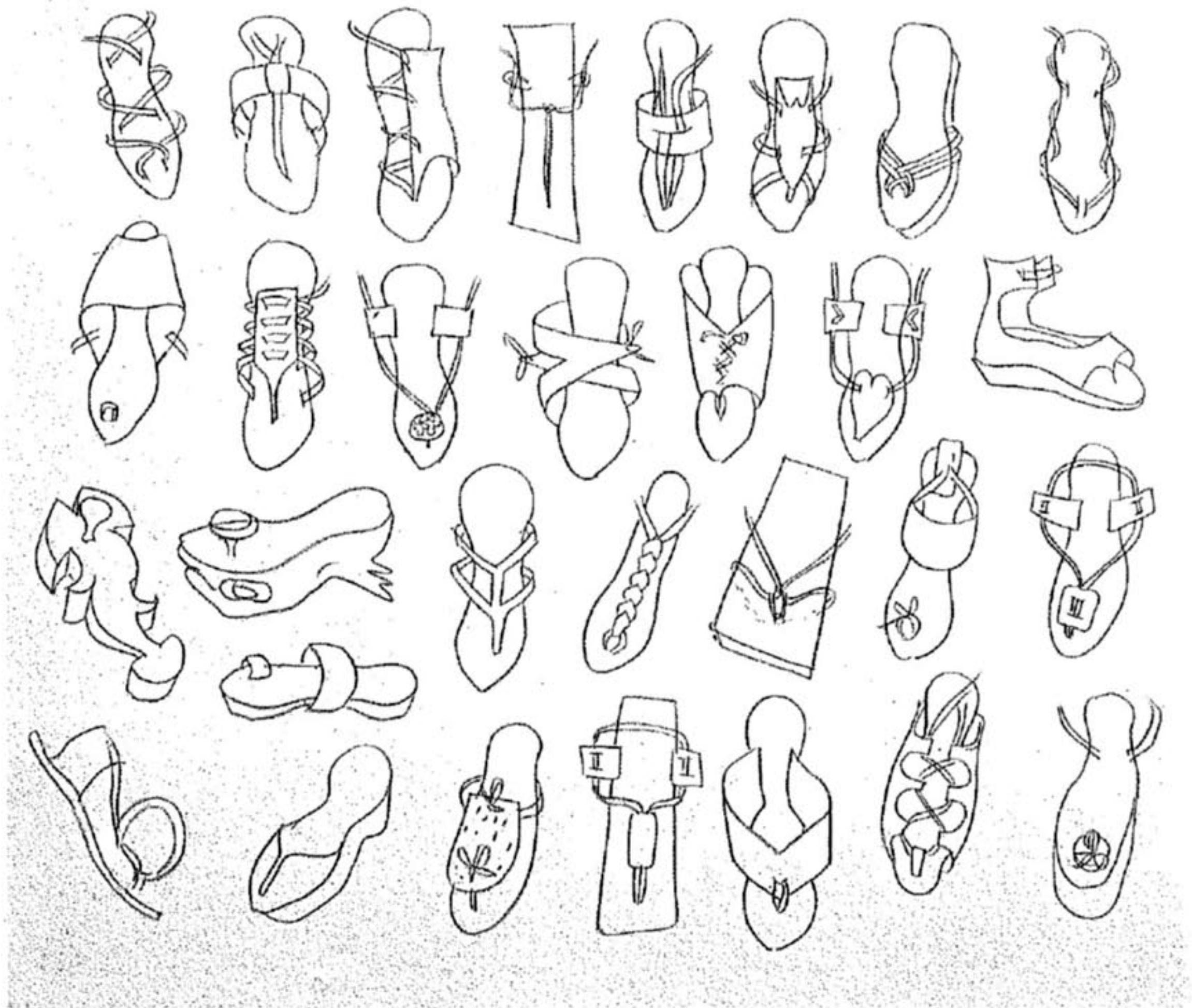

See Catalogue no. 41 (p. 287)

degenerate into medical pathologies. He invites us to shed sensory barriers and enter into contact with the ground.

In the show *Are Clothes Modern?*, and from 1946 onwards also in the marketplace, Rudofsky proposed, as an alternative, (women's) sandals designed by himself: *Bernardo Sandals*. *Vogue* presented them thus: "Mr. Rudofsky believes that a shoe, instead of supporting the foot, should free it. That the series of arches of which the foot consists will roll along together, creating exercise for the foot if the shoe is open-faced enough to allow it. That a foot, walked this way, is self-improving. So now the girls with the pretty, slim feet will have an engineering, architectural reason for baring their feet."¹²⁴

A schematic text on the history of footwear in the 20th century, published in 1967 in *Harper's Bazaar*, points to *Bernardo Sandals* as

Unknown photographer. Bernardo Sandal style # 504, late 1940s / early 1950s (?). This sandal well exemplifies the simplicity and elegance of certain models of Bernardos, "little more than slabs of fine leather with a few straps attached" to hold them to the feet.

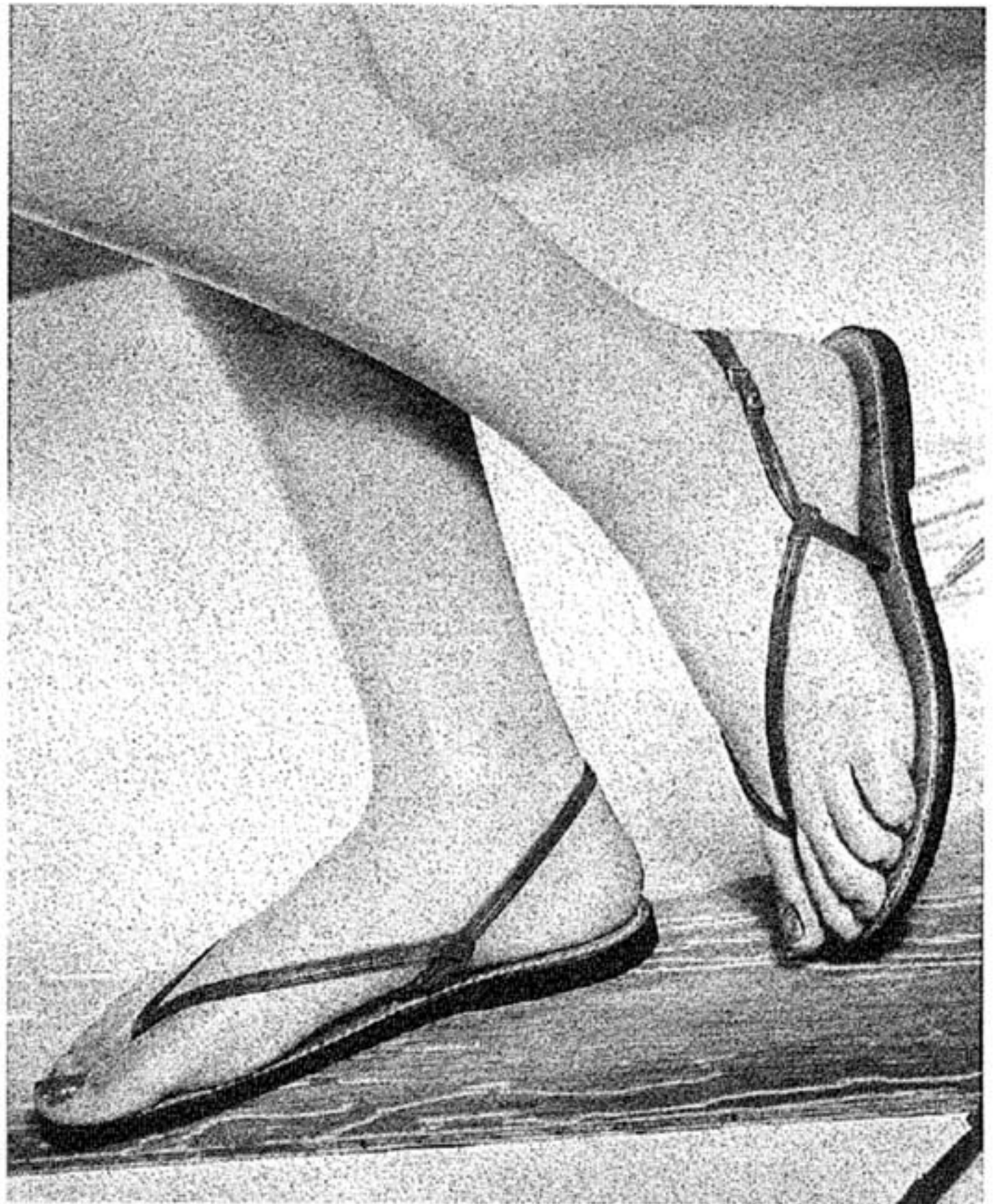

the product that marked the advent of sandals on the fashion scene.¹²⁵ This statement, however, registers more a success in a broad marketplace than any absolute primacy; if the ideal rescue of the sandal may be ascribed to neo-Classicism and to Isadora Duncan, as early as 1927 the *huarache*, a sandal imported from Mexico, immediately became popular in the United States for beach and resort wear. "Open-toed sandals debuted in 1934 in Miami, Florida. Retailers

124 AR46.7.

125 AR67.3.



Louise Dahl-Wolfe. A bathing suit of stinging green from the jungle, the color of an African pear. Bernardo leather sandals, ca. 1952.

were pessimistic about the new styles, but women delighted in them, wearing them with lounging pajamas or at the beach."¹²⁶ At the time of *Are Clothes Modern?*, one already encountered in New York a certain use of "Greek" evening sandals in golden kid.¹²⁷ The sandals spoken of from the twenties onward frequently shared with their predecessors the characteristic of leaving the foot exposed; but, unlike the latter, they were equipped with heels. "Thanks to Ferragamo's invention of the metal arch support, heeled shoes no longer needed toe caps... So by the end of the [1920s], newly liberated toes, nails painted bright red, were peeping out of high-heeled sandals — and soon scanty spaghetti strap styles were showcasing the entire foot."¹²⁸ Whoever should get the credit for the invention of the modern sandal, Cobbler, Mackey, Jantzen and, above all, Capezio and Julianelli were producing sandals in the United States in the period of the *Bernardo Sandals*; their designs, reworkings of the sandals of Capri, were frequently without heels.

Rudofsky's involvement in the design of non-deforming footwear was a lifelong concern: he was already designing footwear at the beginning of the thirties, and at the time of his death was working on a new book on the foot and shoes. This commitment derived from a conviction at once hygienic and ethical. But he was no Konrad Birkenstock: his sandals are comfortable but not anatomical. They were sold in the most prestigious department stores, were constantly being published in *Vogue* and *Harper's Bazaar*, and were designed to showcase the beauty of the female foot. They essentially consisted of a flat leather sole with more or less elaborate straps for holding it

See Biographical note, no. 16 (p. 28)

126 Margaret Allyson, "The glamorous history of Sandals", *Shūz*, vol. III, no. 1, Spring 2000, p. 32–34, p. 126.

127 AR44.20.

128 Linda O'Keeffe, *op. cit.*, p. 24.

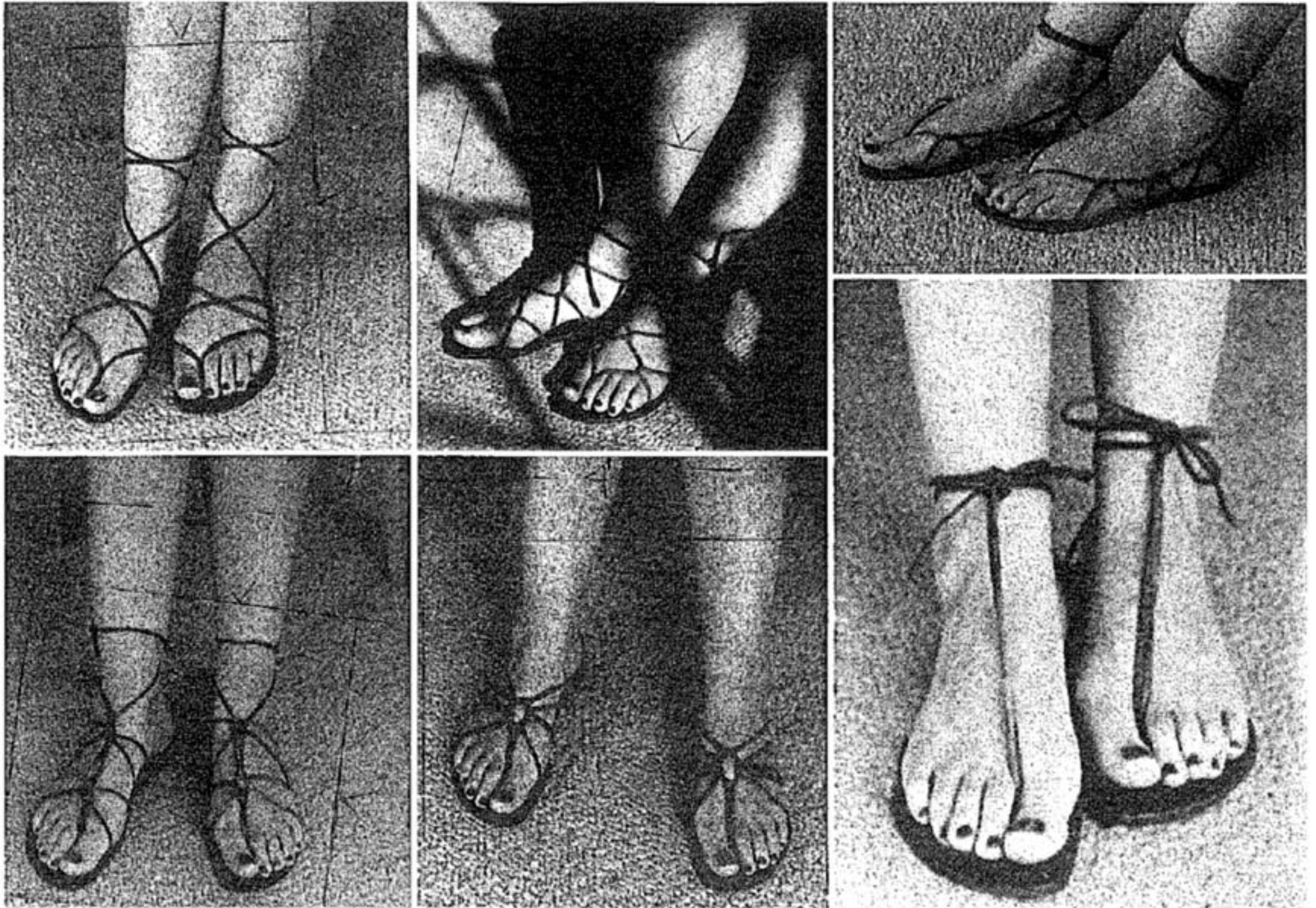

Bernard Rudofsky. Modern man and woman, due to their using box-like coverings, never acquire the ability to wind a turban, wrap a cloak, or lace a sandal, early 1940s.

The pictures show six different ways of lacing the prototype of a sandal which later will be merchandised as "The Net."

See Catalogue no. 68 (p. 308)

in place. Rudofsky was certainly a fetishist, but in the sense that he attributed an erotic appeal to the foot — not to the shoe, and even less to high heels, which repelled him.

One of the *Golden Eye* pedestals, a *paduka* held in place only by a knob between the wearer's toes, is six inches high. Rudofsky intends it as a sexy article, without heels so as not to alter the anatomy of the bones of the foot. It is not meant to be worn in the street (not for functional reasons, but because Rudofsky shunned exhibitionism).

As for clothing, from the thirties on it was Rudofsky's opinion that "the clothes we wear today are anachronistic, irrational and harmful. Moreover, they are expensive and undemocratic."¹²⁹

Taking up Flügel's ideas, Rudofsky holds that clothes, so long as they serve functional purposes, should be unisex.¹³⁰ In male-dominated societies there is an arbitrary difference in dress in order to force "womenfolk into an exaggerated femininity, magnifying their relative weakness into complete helplessness."¹³¹ (This imposition also applies to shoes: the high heel serves to hinder women's ability to walk, making them less independent.) Rudofsky theorizes that making clothing unisex would deprive it of its sexually stimulating connotations, as would be logical in garments for sports or work.

He offers the original motivation for clothing as a sort of utopia: "[A]t

129 ACM, p. 115. Cf. John Carl Flügel, op. cit.

130 ACM, p. 183.

131 UHB, p. 176.

the end of its evolution, dress...will stand as a sublimation of its first motive: decoration."¹³² Echoing the words of Heard, Dunlap, and Flügel, he maintains that clothing — like the bed — is destined to be just an "episode in the history of humanity."¹³³ While awaiting its extinction, we may content ourselves with transparent garments¹³⁴ which reveal and emphasize the body, or clothes which are an extension of the self, reinforcing sensorial stimulation and the body's perception of itself.¹³⁵

Nonetheless, Rudofsky does not develop, save in a secondary manner, the utopia of clothing as mere decoration of a nearly naked body — neither in 1944, when it seemed too advanced, nor later, when it became a reality. The clothes he designs are primarily technical exercises in simplification and rational construction. Like his buildings, they are designed using straight lines. He maintains that the making of the garment is one thing, the manner in which it is worn another: garments in simple geometric shapes, such as the sari or the toga, can be worn in a variety of different ways.¹³⁶ For reasons of simplicity of production and mental cleanliness, Rudofsky wants a "modern cloth," made with very little stitching and very few cuts, that emphasizes the aesthetic value of the fabric more than the shape of the garment. It should be easy to fold and storable in a very small space; without buttons, which are an error in design; producible in a single size, without requiring that



Bernard Rudofsky. Friend in Nivola's solarium, wearing Bernardo Separates (a sleeveless coat, made with "Si & No" fabric, and trousers) and Bernardo Sandals, 1951 (?).

132 ACM, p. 195.

133 UHB, p. 72.

134 UHB, p. 66.

135 BPW, p. 121.

136 ACM, p. 137. In *Are Clothes Modern?*, Rudofsky had already exhibited four garments designed and executed by Irene Schawinsky according to the same principles.

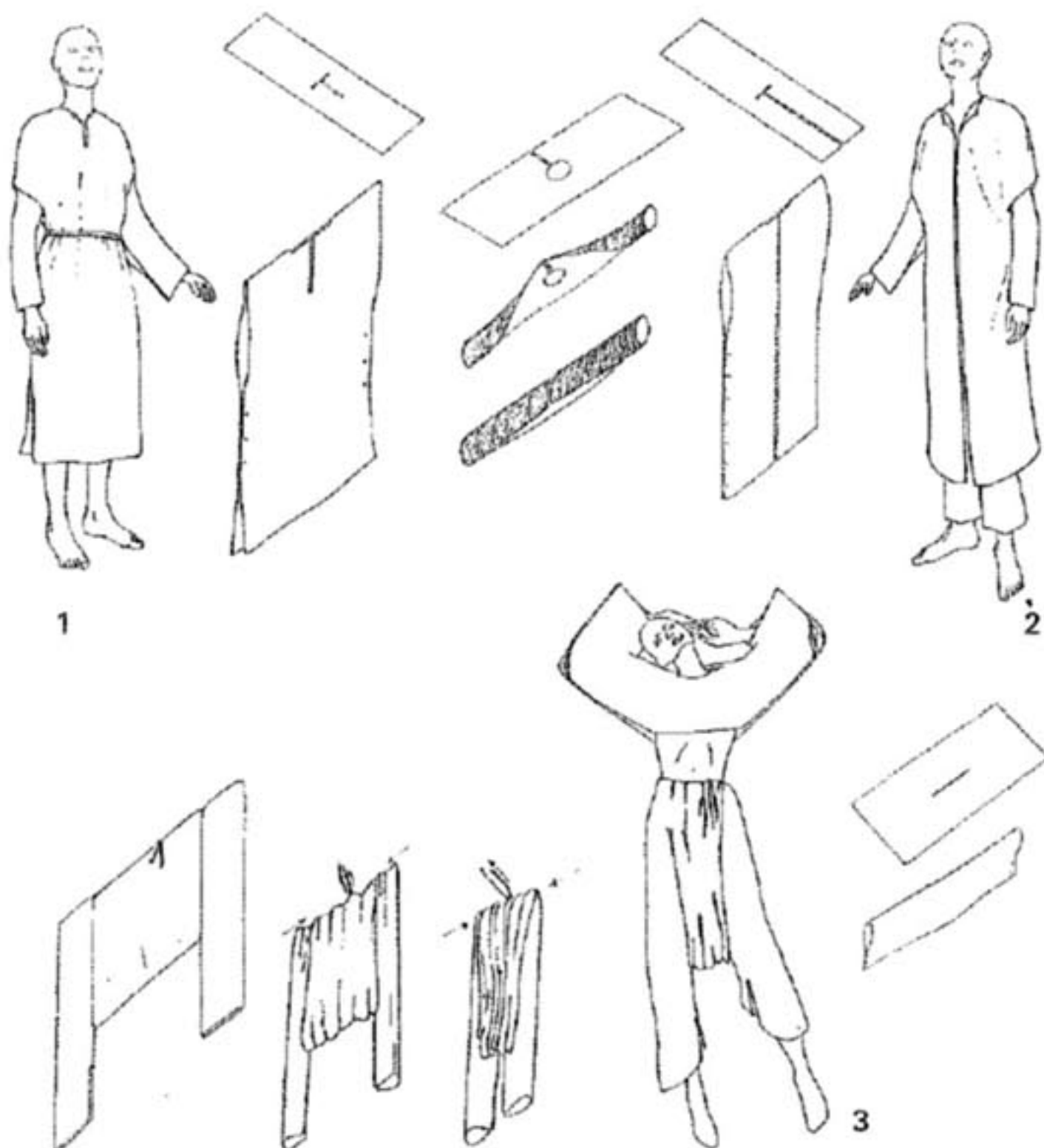

Some possible combinations of Bernardo Separates.

1. — day dress with small sleeves;

2. — jumper with small sleeves, trousers;

3. — big sleeves with trousers.

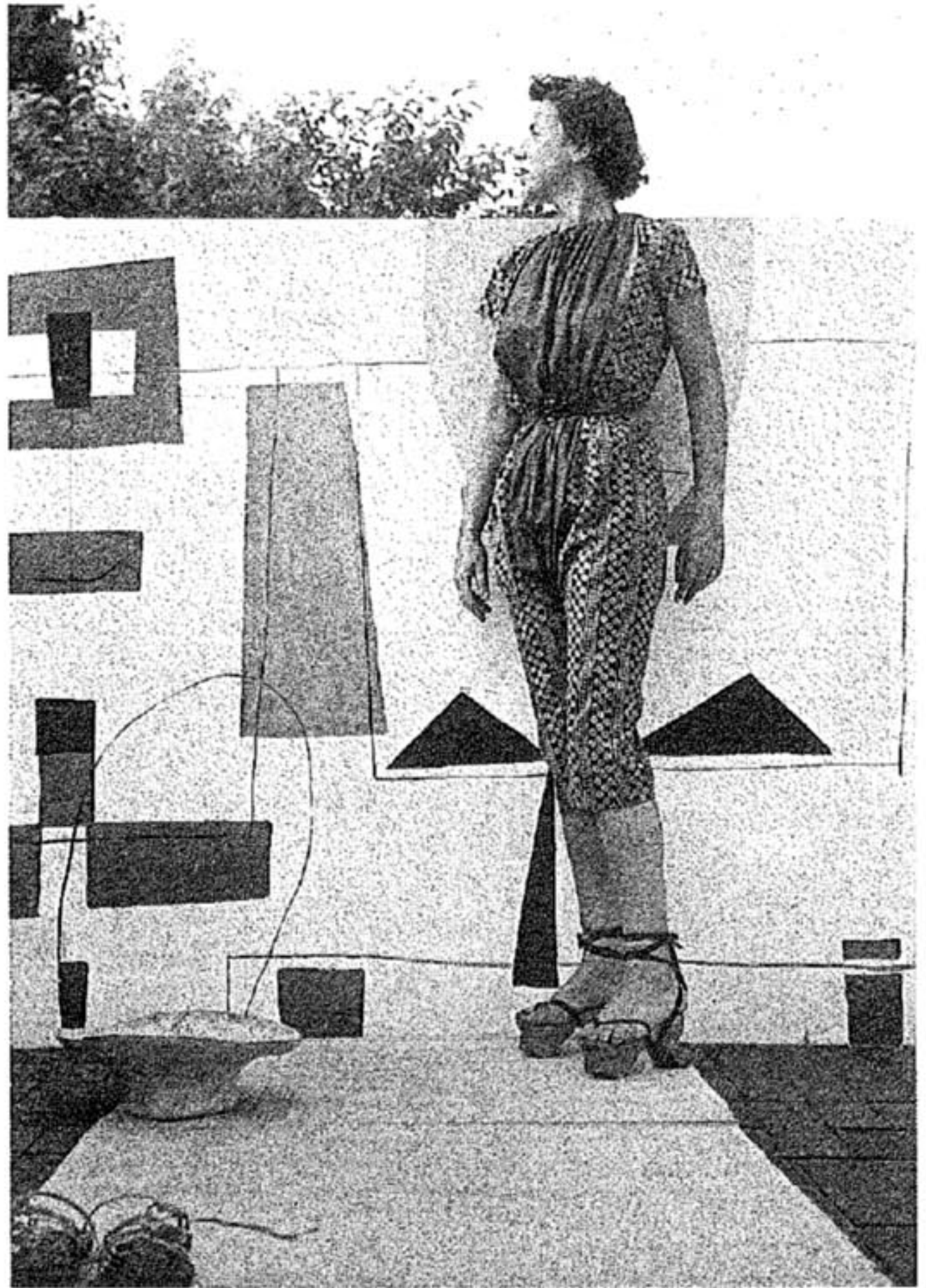

Bernard Rudofsky. Friend in Nivola's solarium, wearing Bernardo Separate "Allinone" and Bernardo Sandals, 1951 (?).

