

Alternative procedure to verify the H-V diagram after external installations on helicopters

Original

Alternative procedure to verify the H-V diagram after external installations on helicopters / Battipede, Manuela; di caprio, Raffaele; Bleyer, Manfred; Vazzola, Matteo. - ELETTRONICO. - Driving down the cost of flight testing without reducing safety margins:(2021), pp. 1-10. (Intervento presentato al convegno 32nd SFTE European Chapter tenutosi a virtual event nel September 15th 2021).

Availability:

This version is available at: 11583/2968467 since: 2022-06-22T11:17:38Z

Publisher:

SFTE EC

Published

DOI:

Terms of use:

This article is made available under terms and conditions as specified in the corresponding bibliographic description in the repository

Publisher copyright

(Article begins on next page)

Driving down the cost of flight testing without reducing safety margins

Alternative procedure to verify the H-V diagram after external installations on helicopters

Manuela Battipede^{*}, Raffaele Di Caprio[†], Manfred Bleyer[‡], Matteo Vazzola[§]

ABSTRACT

Key words: Certification of external installations on helicopters, for modifications for which H-V curve, safety, CS27/29.865 is not applicable, often requires the showing of compliance of paragraph alternative mean CS XX.79 - Limiting height-speed envelope – which might imply, ultimately, a certain degree of H-V testing. of compliance, external installation. STC.

Due to the implications on safety during the investigation of the H-V curve, a preliminary analytical investigation is advisable, to understand whether H-V test can be drastically reduced. Analytical investigation, though, is usually based on the extensive use of simulation data, based on validated dynamic mathematical models, which are usually not available to the applicant.

TPS recently proposed an alternative method, based on the analysis of a set of flight tests, which is meant to assess the different phases of the physical/mechanical phenomena related to the emergency maneuver performed by the pilot as a consequence of a power loss, within or in the proximity of the H-V curve. More in details, the analysis of the autorotation phenomenology reveals that the maneuver is made up by different phases and dedicated tests have been proposed to assess each of these phases. The whole test campaign is hence meant to gain a thorough insight of how, and specifically in which part of the maneuver, the external modification could affect the helicopter H-V characteristic. Depending on this substantiation, H-V testing can be avoided or drastically reduced, limiting the investigation to a few meaningful points.

The proposed method has been recently assessed by TPS on an external basket installation, making use of purposely developed TPS's Flight Instrumentation and post-processing tools. More in details, results and conclusions are based on the analysis of static and dynamic flight parameters, acquired with a non-intrusive FTI, which monitors and correlates cockpit parameters and flight commands, following a back-to-back approach (i.e. pre and post modification).

The method demonstrated was witnessed by EASA and found acceptable as an alternative method for showing of compliance to the applicable requirements.

1. List of symbols

AEO All Engines Operative
AGL Above Ground Level
CAS Calibrated Airspeed
Hd Density altitude

Hp Pressure altitude
FAQ Frequently asked questions
FC Flight Conditions
IAS Indicated Air Speed
IGE In Ground Effect
KIAS Indicated airspeed in kt

^{*} Politecnico di Torino – C.so Duca degli Abruzzi 24 – 10129 Torino – Italy - manuela.battipede@polito.it +39 335 287540

[†] EASA - Konrad-Adenauer-Ufer 3, D-50668 Cologne, Germany - raffaele.dicaprio@easa.europa.eu +49 151 51143 455

[‡] Ingenieurbüro für Luftfahrt - Holunderstrasse 23 A-3032 Eichgraben – Austria - office@imb.aero +43 (0) 664 1012444

[§] TPS SpA – Corso Tazzoli 215, 12B - 10137 Torino – Italy - matteo.vazzola@tps-aerospace.it +39 348 4009494

LFTE	Lead Flight Test Engineer
LH	Left hand
NR	Rotor speed
OAT	Outside Air Temperature
OEI	One Engine Inoperative
OGE	Out of Ground Effect
RFM	Rotorcraft Flight ManualRH
ROC	Rate of Climb
ROD	Rate of Descent
RPM	Revolutions per minute
SL	See level
STC	Supplemental Type Certificate
TC	Type Certificate
TP	Test Pilot
TQ	Torque
VFR	Visual Flight Rules
V _Y	Speed of maximum ROC
Ω	Rotor speed

2. Introduction

A request was made to TPS from a helicopter operator, to certify the external installation of one or two purposely manufactured baskets on the AS350 series, including the AS350 B1, B2, B3 and B3e series, to increase the payload volume capacity up to 0.140 m³ for each basket.

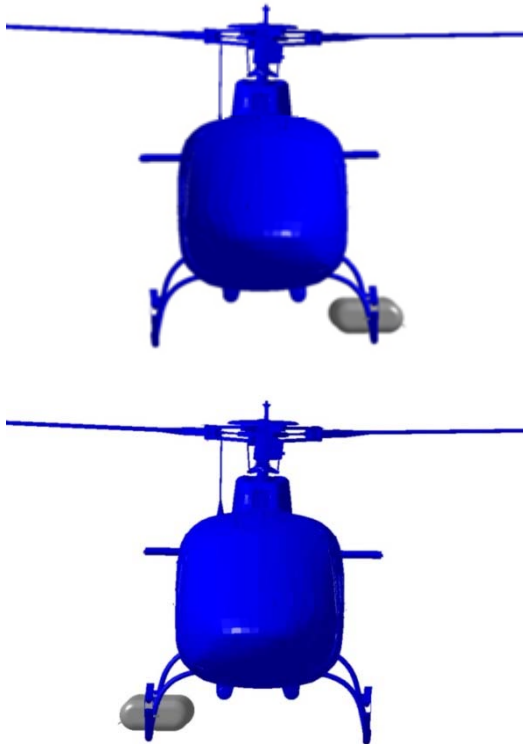

Figure 1 – Asymmetrical single basket configurations



Figure 2 – Symmetrical dual basket configuration

Each of the two baskets can be positioned on the helicopter skid with an upward opening and mounted in an asymmetrical configuration (left or right single basket, Figure 1) or in a symmetrical configuration (dual basket, Figure 2)

According to EASA Part 21 (ref.[1.]), this modification is considered a major change, which implies that a certain number of affected structural and flight requirements need to be re-assessed.

In 2019, to support the industry involved in compliance demonstration of major changes or STC, EASA issued the Certification Memorandum on External Installations on Helicopters (ref.[2.]), which provides specific guidance for certification of external installations, that are considered non-extensive in terms of weight, external surface and/or volume.

The Memorandum indicates flight testing as the most viable mean for flight substantiations and showing of compliance with the affected requirements and endorses practical approaches which have proven to be effective and consistent with the consolidated guidance material contained in ref. [3.] and [4.] .

Although the provided guidance material is non-binding, it is generally considered a relevant support by the applicants, as it contains a great extent of practical indications derived from valuable lessons learned in the wider civil and military aviation community.

For example, a sound approach encouraged by the memorandum to show compliance with the performance requirements, when the minimum spec engine is not available, is to perform tests on both the unmodified (or baseline) and modified configuration. This method is known as 'back to back' approach and is specifically meant to assess the effects of the modification on the degradation of performance. As for

engineering judgment, some points of the flight envelope are expected to be more affected by the modification than others and it is crucial that the comparison is made at the most critical conditions of the envelope for which certification is sought. The approach was considered effective for the certification of the basket installation and, to reduce the number of scheduled flights, the idea was to compare only a selection of configurations at the time, limiting performance tests related to the longitudinal plane to the comparison between the baseline and the performance-related worst-case scenario, which is the symmetrical configuration with dual baskets. It was considered to be the most critical for performance because it involves a greater increase in drag.

Handling qualities tests usually do not involve comparison with the baseline configuration as a demonstration at the most critical condition is deemed appropriate to show compliance with the applicable requirements, without requiring additional testing effort to compare data with the baseline configuration. It was hence decided, for the basket installation investigation, that handling qualities tests related to the longitudinal plane were to be performed on the symmetrical configuration with dual baskets. Handling qualities tests related to the latero-directional plane had to be performed on the asymmetrical configurations, with the RH or LH single basket.

Extensive technical consultation among the parties involved in the definition of the certification program, though, was dedicated to a specific paragraph of the memorandum, which indicates that for modifications for which CS 27/29.865 is not applicable, H-V diagram investigation must be performed to show compliance with requirement CS 27/29.79.

Flight test investigation of the H-V curve, if executed as indicated by the reference guidance material, ([3.] and [4.]) involves a certain numbers of autorotation landings from low-speed, low-altitude initial points, that, even in the most conservative build-up approach, involve a substantial inherent risk ([6.])

From the initial investigation of the basket installation certification program, paragraph CS 27.79 was identified as potentially affected by the change. Due to the aforementioned implications on safety during the investigation of the H-V curve, though, a preliminary analysis was performed to understand whether H-V

testing could be drastically reduced. This analysis was entirely based on engineering judgment and was initially used to assess the safety of flight for the Flight Conditions approval. It was indicated that this preliminary analysis had to be subsequently supported by the test results obtained in the first part of the test campaign, which did not involve H-V curve testing.

3. Test Article identification

To assess the impact of the external modification on the AS350 B1, B2, B3 and B3e series, a AS 350 B2 was identified as test article. The representativeness of the test article for showing of compliance was motivated by the following considerations: AS 350 B2 is representative of all the series, in terms of operative ranges, but is characterized by the worst performance, as, under the same maximum take-off mass, the engine is slightly less performant (Table 1). The RPM range in Power ON is slightly restricted with respect to the B3 and B3e series, whereas the RPM range in Power OFF is the same for all the series (Table 2).

	Engine Model	MTOP [Kw]
AS 350 B1	Turbomeca Arriel 1D (EASA Engine TCDS E.073)	510 Kw
AS 350 B2	Turbomeca Arriel 1D1 (EASA Engine TCDS E.073)	531 Kw
AS 350 B3	Turbomeca Arriel 2B/2B1 (EASA Engine TCDS E.001)	557 Kw
AS 350 B3e	Turbomeca Arriel 2D (EASA Engine TCDS E.001)	557 Kw

Table 1 - Engine

	Power ON	Power OFF
AS 350 B1	- Max 394 rpm - Min 385 rpm	- Max:430 rpm - Min: 320 rpm
AS 350 B2	- Max 394 rpm - Min 385 rpm	- Max:430 rpm - Min: 320 rpm
AS 350 B3	AS 350 B3 Arriel 2B: - Max 394 rpm - Min 385 rpm AS 350 B3 Arriel 2B1: - Max 405 rpm - Min 375 rpm	- Max: 430 rpm - Min: 320 rpm
AS 350 B3e	AS 350 B3 Arriel 2D: - Max 405 rpm - Min 375 rpm	- Max: 430 rpm - Min: 320 rpm

Table 2 - Rotor Speed Limits

Certification was requested for night and day VFR condition, up to a maximum pressure altitude $H_p=10000$ ft.

4. Preliminary analysis

As a preliminary consideration, from the analysis of Figure 3, it was noticed that the baskets are external to the fuselage footprint. In particular, part of the basket footprint is within the hub disk, which is 24% of the disk radius or 10% of the rotor area. The remaining part of the basket footprint is confined between the hub radius and a distance which is about 32% of the total rotor radius.

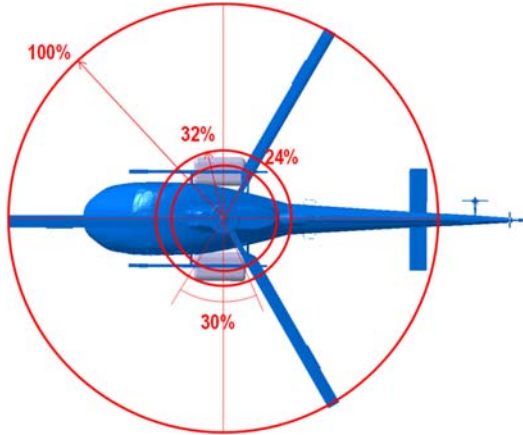

Figure 3 – Basket footprint

Considering that only about 30% of the 360 degrees blade rotation is affected by the presence of the baskets, it was estimated that the baskets would hence affect, in total, only 1.5% of the disk area which is effective in producing the aerodynamic forces.

The H-V curve verification implies testing whether, in case of a sudden power loss and within limits of altitude and speed, the rotor maintains enough energy for entering autorotation in a forward descending trajectory, which precedes flare and landing, that must be performed maintaining vertical and forward speeds within acceptable limits.

In more details, in case of a power loss, the rotor torque will be reduced, causing a rotor speed decay. The initial rotor speed decay rate can be estimated by the following equation:

$$\dot{\Omega} = \frac{\Delta TQ}{I_R}$$

where ΔTQ is the resultant of the rotor torque (which is unbalanced because of the torque drop) and I_R is the rotor inertia. The maneuver to enter autorotation consists in the sudden reduction of the collective pitch: by reducing the blade pitch, in fact, the rotor drag can be reduced and the resultant of the aerodynamic forces

can rotate in order to propel the blade and increase the rotor speed. The use of the cyclic control counteracts the helicopter tendency to pitch down (or pitch up, depending on the helicopter and the actual CG position). In steady autorotation, a given value of the collective pitch will cause the helicopter to settle on a unique descent speed and rotor speed combination. The pilot can therefore control the rotor speed, commonly referred to as *RPM*, using the collective pitch – the lower the pitch the higher the rotor speed – but in practice the usable range of rotor RPM is very restrictive. If the rotor speed is too low the blade will stall and lose lift. If it increases over the prescribed upper limits, loads on the rotor hub and blade roots could exceed the structural limits. The safe range is typically within 80% and 120% of the nominal Power ON speed, for transient excursions, and between 90% and 110% for stabilized conditions. For the AS350 B2, B3 and B3e series this values are indicated by the TC Holder RFM (ref. [6.]) as 320 and 430 *RPM* for the transient and 360 and 410 *RPM* for the stabilized autorotation.

The scientific literature (ref. [8.]) reports that factors affecting the rotor speed decay are mainly the rotor inertia, the rotor speed and torque requirement at the instant of power loss and the ratio of the thrust required over the maximum thrust the rotor can produce. In particular the decay time could be shortened, with a beneficial impact on safety, by decreasing the rotor inertia, decreasing the nominal rotor speed or by increasing the thrust that the rotor has to produce under normal power-on conditions.

Important additional factors include the action of the pilot in attempting to contain the rotor speed within the limits and the effect of the rate of descent on the angle of attack of the rotor blades, which will depend on the blade pitch.

In more practical terms, the pilot will attempt to arrest the rotor speed decay and contain the rotor speed within narrow limits by rapidly reducing the collective pitch. This maneuver has the effect of increasing the rate of descent, while unloading the rotor blades, thereby reducing, and ultimately reversing, the decelerating torque applied to the rotor. Another important key is, hence, the delay time, defined as the time between an engine failure and the pilot commencing the corrective action, by rapidly lowering

the collective lever. The maximum delay time is the delay that causes the rotor speed to reach the minimum Power OFF transient value before rising to achieve a stable autorotative condition (Figure 4).

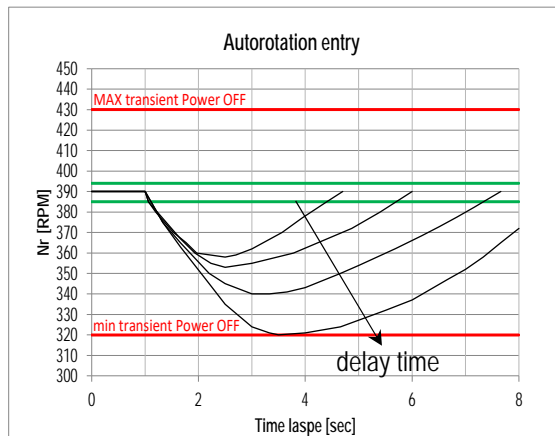

Figure 4 – Effect of time delay on rotor speed in autorotation

According to the AS350 RFM (ref. [6.]), independently from the series, the avoidance zone (Z) is defined by the four points A,B,C,D, as reported in Table 1 and Figure 5.

point	condition (@ SL)
A	8 ft (2.5 m) @ zero airspeed
B	25 ft (9 m) @ 40 knots (74 km/h)
C	constant height of 100 ft (30 m) @ variable airspeed, depending on the density altitude and on the aircraft weight determined by line (C).
D	- constant zero airspeed - variable height depending on the density altitude and on the aircraft weight as determined by line (D).

Table 1 - Airspeed-Height envelope (ref. [6.])

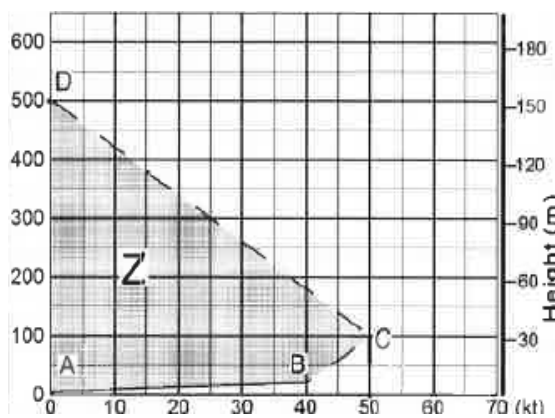

Figure 5 - H-V diagram (ref. [6.])

Point D is at constant zero airspeed. It was estimated that the embodiment of the baskets could have had an impact on drag increasing, in case the rotorcraft speed were above a minimum value. In point D this effect is

not detectable. Chances were, however, that a difference in the power required to maintain the hover condition was measured, as the presence of the basket could have had an effect on the induced velocity distributions and, ultimately, on the dynamics which proceed the entrance in autorotation. This effect was expected to be proportional to the percentage of the rotor area affected by the basket potential blockage, which was roughly estimated around 1.5%. Hover condition, though, was indicated as a condition to be investigated.

Point C, also known as the knee point, is the most critical point of the H-V curve, as it involves a very low ground height combined with a rotorcraft speed for which the additional drag generated by the baskets could have been detected.

Points A and B are at very low ground height: for these combination of height and speed, it was estimate that the presence of the baskets was irrelevant, if not be beneficial, because it would have not involved an increment of weight, but would have offered, in case, a wider resistant surface to slow down the rotorcraft drop.

The knee point separates the take-off portion from the cruise portion of the HV curve. AC27.79, which is the acceptable means of compliance for the CS27.79 requirement, indicates that flight testing for demonstrating the HV curve should be conducted by using a minimum time delay of 1 second between engine out simulation and control actuation for the point above the knee. Below the knee, the normal pilot reaction time could be used.

5. Alternative method for showing of compliance

The key point, of the proposed alternative method for showing of compliance with requirement CS27.79, is to investigate all the phases of the landing maneuver in autorotation as a consequence of a power loss and analyze whether the embodiment of the external installation could have an impact on any of them. The analysis is performed statistically, as a comparison of the different configuration (pre and post the embodiment of the change). The autorotation phenomenology reveals that the impact of an external installation on the H-V curve can be assessed by analyzing the following characteristics:

- the OGE hover performance, with a comparison of the power necessary to hover

at different heights, between the baseline and modified configurations. In this phase the key characteristic parameter is the power required to hover, which is measured through the torque level, compared to the actual helicopter weight;

- the transition phase from the Power ON and Power OFF conditions (autorotation entry phase), or, more properly, the autorotation characteristic parameter NR time variation immediately after the maneuver performed by the pilot to enter the autorotation after a power loss (Figure 4);
- after a power loss in hovering, the key characteristic is the ability to accelerate to V_Y , which is approximately equal to the speed of maximum rate of climb (ROC). To quantitatively assess the acceleration characteristics in this phase, measurements are focused on the loss of altitude ΔH (Figure 6) necessary to accelerated, in a glide, the rotorcraft in autorotation from 0 to the flare speed V_Y ;
- the flare, which is assessed qualitatively in terms of the effectiveness of the controls to flare the helicopter in the actual configuration.

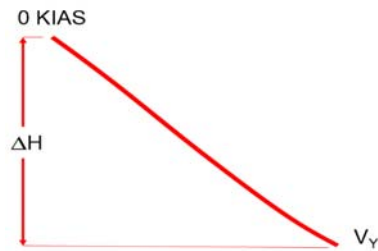

Figure 6 - Glide: transient form from the autorotation entering to the minimum RoD speed

Part of the first phase of the flight test campaign was hence dedicated to gather data that could give quantitative evidence in support of the proposed method and specific tests were planned and performed to investigate the four different abovementioned phases.

Hovering OGE

According to the back-to-back performance assessment approach, hovering OGE performance was analyzed both in the baseline and modified configurations. The objective of hover performance

tests was to determine the power required to hovering out of ground effect, at different gross weights, with particular relevance for the maximum take-off mass, to assess the high hover point of the H-V curve. Hover performance test were executed with the free hover flight test technique (ref. [9.]). Helicopter gross weight was varied starting from the maximum take-off weight of 2250 kg to 1822 kg, by removing ballast and/or crew at each test point and with fuel consumption. This procedure allowed to produce data related to a generalised gross weight $GW/\sigma N_R^2$ spanning from 1948 to 2421 kg.

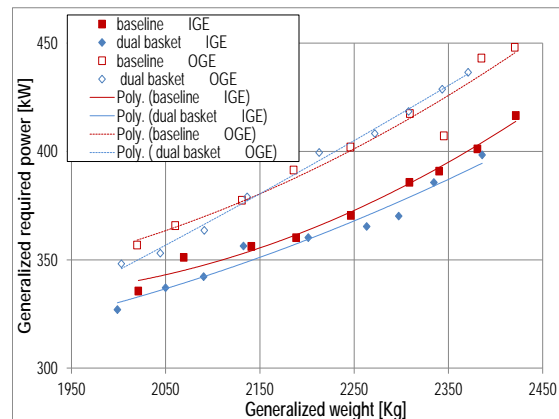

Figure 7 – Performance in hovering IGE and OGE for the baseline (in red) and modified (in blue) configurations

Results shown that the presence of the baskets does not affect the OGE hover performance, which means that, in case of an engine failure in hovering (high hover for the H-V curve), autorotation could potentially start from the same rotor disk load distribution and with the same initial torque, hence producing the same initial rotor speed decay.

Autorotation entering

The assessment of the effect of the embodiment of the change on the autorotation time delay is essential in the H-V curve analysis. To this purpose, a comparison was performed between the clean helicopter configuration (baseline) and the modified helicopter configuration (both single and dual basket).

As a safety precaution, prior starting the HV testing multiple full touchdown autorotations were performed from various altitudes. The helicopter was at maximum gross mass for both the configuration.

The test consisted in a series of maneuver to enter autorotation starting from the hover condition. The

LFTE initiated a simulated engine failure by retarding rapidly the fuel control lever to a 'ground idle position'. A minimum of 1 second delay between the initiated power loss and control actuation was utilized. Following the time delay the collective was lowered and height loss in relation to the time needed to achieve a speed in the range of 50 to 55 KIAS was measured. Rotor speed decay was monitored and video recorded. Upon reaching 50 KIAS the autorotation was recovered by adding engine power via the fuel control lever. This procedure was repeated at least three times for each configuration, as to obtain statistically meaningful results.

During these test two different time frames have been analyzed:

- the transient from the engine simulated power loss to the autorotation entering;
- the transient from the autorotation entering to the V_Y speed.

Results for the transient from the engine stop to the autorotation entering are presented in Figure 9 for the baseline configuration, Figure 10 for the asymmetrical single basket configuration and Figure 11 for the symmetrical dual basket configuration. They have been collected with a post flight statistical analysis and plotted to show how and when the reduction of N_R reaches the minimum transient power-off rotor speed.



Figure 8 – N_R range limitations in flight (green) and autorotation (red)

Power ON	Power OFF
385 to 394 rpm	- Maximum: 430 rpm (audio warning above 410 rpm) - Minimum: 320 rpm (audio warning below 360 rpm)

Table 3 - N_R range limitations in flight and autorotation

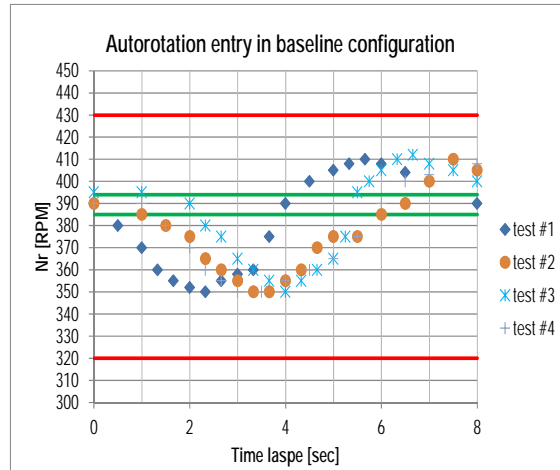

Figure 9 - Transient from engine stop to autorotation entering – baseline configuration

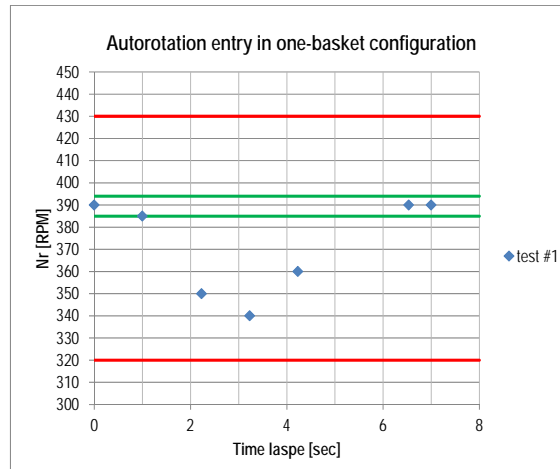

Figure 10 - Transient from engine stop to autorotation entering – asymmetrical one basket configuration

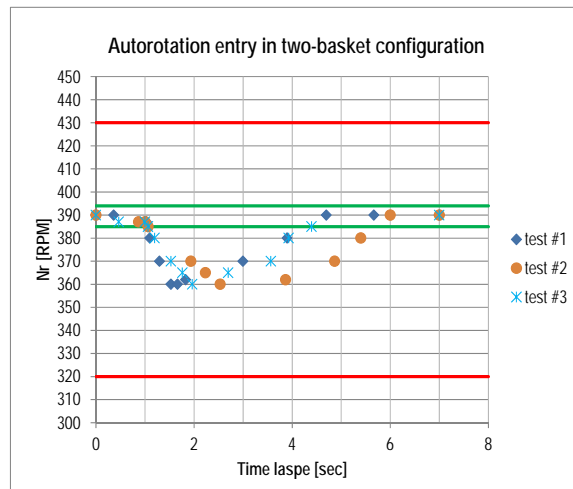

Figure 11 - Transient from engine stop to autorotation entering – symmetrical dual basket configuration

It must be noticed that among the autorotation entry tests performed in all the configurations, only the most significant results have been reported.

Results reported in Figure 10 and Figure 11 (test # 1, # 2 and # 3), in particular, refer to the first phase of the flight campaign (February 2019), for which hovering was stabilized at $H_p=3000ft$, whereas results of Figure 9 and Figure 11 (test # 5 and # 6) refer to the first phase (July 2019) for which hovering was stabilized at 1000ft AGL. In this second phase, a constant wind level of 5 to 10 kts was observed, with major effects at 1000ft AGL, but tests in the two configurations (baseline and dual basket) were performed in the same conditions, and precisely with the same flight heading and in a time lapse of less than two hours, for which no difference in the environmental conditions was observed. It was estimated that the effect of the wind was the same on both the configurations and ultimately unimportant on the comparison.

In all the configurations, the autorotation minimum rotor speed is never reached and the autorotation is stabilized within 8-9 seconds from the engine stop.

To analyze the transient from the autorotation entering to the minimum RoD speed, data were collected in both phases of the flight testing. In particular, results reported in Table 4 refer to the first phase and precisely to the following initial conditions:

- $MTOW = 2250\text{ kg}$
- aft CG
- $H_p = 8000ft$

As a reference final speed test $V_y=55\text{ KIAS}$ was selected.

Conf.	Hp in [ft]	Hp fin [ft]	time [sec]	ΔH [ft]	Avg. time [sec]	Avg. ΔH [ft]
Modified asymm. (single basket)	8000	7700	10.99	300	11.17	300.00
	8000	7700	11.19	300		
	8000	7700	11.33	300		
Modified symm. (dual baskets)	8000	7650	10.61	350	11.79	316.67
	8000	7600	12.32	300		
	8000	7600	12.44	300		

Table 4 - Transient from the autorotation entering to the $V_y=55\text{KIAS}$ at high altitude (hover stabilized at $H_p 8000ft$)

Results reported in Table 5 are related to the second phase of the flight testing and refer to the following initial conditions:

- $MTOW = 2250\text{ kg}$
- Centre CG
- 1000 AGL (H_p was approximately 1600ft, with temperature ranging from 30 to 35 Celsius and H_σ consequently ranging from 3600 to 4300 ft)

As a reference final speed test $V_y=50\text{ KIAS}$ was selected, to reduce the altitude drop during tests.

Conf.	Hp in [ft]	Hp fin [ft]	time [sec]	ΔH [ft]	Avg. time [sec]	Avg. ΔH [ft]
Baseline	1600	1400	8	200	9.00	190.00
	1670	1480	9	190		
	1600	1420	10	180		
Modified symm. (Dual baskets)	1630	1400	10	230	9.05	203.33
	1560	1380	7.66	180		
	1600	1400	9.5	200		

Table 5 - Transient from the autorotation entering to the $V_y=50\text{KIAS}$ at low altitude (hover stabilized at 1000ft AGL)

Results reveal that the behavior of the rotorcraft in both the configurations is acceptable. Moreover, differences in the transient dynamics for the two modified configurations are unnoticeable both in terms of speed and altitude loss.

Flare

Flare characteristics were investigated in a qualitative way during purposely planned tests. Tests were conducted at low altitude performing quick stop maneuvers at different speeds and flare angles for the three configurations: baseline, modified with single basket and with dual baskets. The Test Pilot commented that there was no noticeable difference in the stopping distance and in the effort requested to flare the helicopter.

6. HV curve determination

For the proposed installation, based on the flight test results, it could be assessed that:

- the OGE hover performance is not affected, therefore, the torque required for flight conditions in the low-speed regime is

unchanged, producing no change in the initial rotor speed decay rate following engine failure;

- there is no significant change in the autorotation entry characteristics of the helicopter, with similar rotor speed recovery and following acceleration towards the minimum descent rate speed V_y for the autorotation in terms of height loss;
- The glide performance at V_y remain unchanged, resulting in the ability for the pilot to set up the same autorotation descent
- The flare characteristics of the helicopter are unchanged.

Based on the above, it could be concluded that the HV curve for the proposed installation is unchanged with respect to the baseline certified configuration.

7. Conclusions

The proposed alternate approach on HV testing based on the use of a preliminary phenomenological investigation to any actual flight test allows STC applicants for external installations to drive down the costs of flight testing without reducing safety margins.

In particular, the method consists in dividing the autorotational landing maneuver following an engine failure into the four characteristic phases and conducting for each phase flight test for comparison of the key parameters between the unmodified (baseline) and modified configuration.

The proposed method allows a considerable reduction of test points, therefore reducing the cost of flight testing, without reducing the effectiveness and the validity of the results. Moreover, it further enhances flight safety during the test campaign, as only the affected and relevant parts of the HV curve are required to be verified with actual flight test data.

In particular, the following are the major benefits both in terms of safety and cost/efficiency that have been identified:

- No complete engine out landing starting from the edge of the H-V curve or in its proximity were conducted. Full autorotation landings were only conducted as safety precaution and for crew training before starting the autorotation entry testing.

- All testing involving engine failure simulation or autorotation can be performed at safe height above terrain, since there is no more requirement to demonstrate full autorotation landing starting from specific height/speed points as for the case where the full H-V curve is demonstrated.
- It has been estimated that less than 30 test points were needed to investigate and demonstrate the H-V diagram as opposed to the foreseen 80+ test points for a complete investigation of the H-V curve at the maximum take-off mass, at least 2 density altitude (low and high altitude field), using a proper build up approach in speed and height.
- The test method, does not require performing the testing at a high altitude site, in order to gather data for the demonstration of the HV diagram up to the maximum take-off and landing altitude, as per certification requirement.

Reference

- [1.] Commission Regulation (EU) 2015/1039, amending Regulation (EU) No. 748/2012
- [2.] EASA CM No.: CM-21.A-D-002 Issue 01 issued 27 September 2019
- [3.] FAA AC 27-1B, Chg 8, Certification of Normal Category Rotorcraft, 29th June 2018
- [4.] FAA AC 29-2C, Chg 8, Certification of Transport Category Rotorcraft, 7th February 2018
- [5.] <https://www.easa.europa.eu/sites/default/files/dfu/Flight%20Test%20Categories%20table%20of%20examples%20rev5.pdf>
- [6.] AS 350 B2 Flight Manual, approved by DGAC-F on April 26, 1989 or later approved revision
- [7.] DI CAPRIO, R., PECILE, N., 'Flight Test For H-V Diagram Determination Of A TH-500 Helicopter Equipped With New Main Rotor Blades' - 21th SFTE (EC) Symposium 3÷6 October 2010 - Vergiate (VA) Italy
- [8.] A.K. Cooke, E. W. H. Fitzpatrick, Helicopter Test And Evaluation, Blackwell Science, 2002
- [9.] USAF Aerospace Research Pilot School - Edwards Air Force Base FTC-TIH-70-1001 - Performance - Jan.1973



Manuela Battipede is Associate Professor in Flight Mechanics at the Politecnico di Torino, where she received her Ph.D. in Aerospace Engineering in 2000 and where she is now full member of the Ph.D. faculty of Aerospace Engineering. She is author of more than 100 international journal and conference papers in the areas of Atmospheric Flight Mechanics, Aircraft Modeling & Simulation, Aircraft Guidance Navigation & Control. She has collaborated with numerous international universities and research centers in Europe and in the USA, and appointed by the European Community as an expert to assist in the evaluation of grant applications, projects and tenders. Manuela Battipede is also FTE (Flight Test Engineer) and Flight CVE (Compliance Verification Engineer) for the certification of aeronautical changes for aircraft / rotorcraft CS-23, CS-27 and CS-29, for different DOA within the EC. She serves as Performance and Flight Mechanics CVE in Kopter since April 2021.



Raffaele Di Caprio joined the Italian Air Force in 1992. Upon graduation in Aerospace Engineering, he was assigned to the Italian Air Force Flight Test Center in 1998 and qualified as Rotorcraft Flight Test Engineer attending the US Naval Test Pilot School Class 117 in 1999-2000. He was involved in many military and civil certification programs including flight testing on both fixed and rotary wing aircraft, including the AW139, NH-90, CH-47F, HH-101, TH-500B, EF-2000, C-130J, C-27J and Tornado and was appointed as Chief of the Aeromechanical Flight Test Section and Deputy Technical Director. He was also Aerodynamics and Performance Flight Test instructor for the Production Flight Test Course held by the ITAF Flight Test Center and lecturer of Helicopter Aerodynamics at the Italian Air Force Safety Institute. In 2013, he joined the European Union Aviation Safety Agency (EASA) as Rotorcraft Project Certification Manager for the Super-Puma and AW189 helicopters. In 2018 he was selected as Lead Cat 1 Flight Test Engineer and assigned as project FTE to various programs such as the Leonardo AW169 and AW139, Kopter AW09, Bell 505 and involved in many certification programs. Currently he is Focal Point for NVIS and HTAWS. Raffaele has gained more than 700 Flight Test FHs on more than 40 types both rotary wing and fixed wings.



Manfred Bleyer, born in Austria began his flight activity flying gliders with the age of 15. In 1981 he joined the Austrian Ministry of Interior, Air Support Unit as an engineer and became later a helicopter pilot. He served for 42 years in the Austrian Air Support Unit as a certified engineer, Flight Instructor and Examiner, where he retired in 2019. Since 2003, in addition to his employment, Mr. Bleyer provides support to Industry and Authorities through his Engineering Office for certification, training and Flight Test, involving a variety of rotorcraft, among which R22, B206/206L, AS350, AS355, MD 900, HU 500, B412, EC135, EC 145, AW 109, AW139, AS332 and EC225LP. His wide experience in the helicopter industry contributes to his involvement as a certified court expert. Currently he is involved in HEMS, Pilot Training and various Flight Test activities.



Matteo Vazzola is currently employed in TPS Group as Technical Director. Inside the DOA Manual he covers the roles of Head of Design and Compliance Verification Engineer (CVE) for Avionic Systems, Electrical Systems and ATA 35 Oxygen systems. He received his PhD in Aerospace Engineering in 2010 at Politecnico di Torino, with a thesis on design and airworthiness of a lighter than air unmanned platform. From 2008 to 2015 he has collaborated as a consultant CVE with DOAs, maturing an experience in the preparation of certification documentation (e.g. Compliance Checklist, Classification of the Change and Certification programs), compliance documentation (e.g. Structural report, Safety assessment FTA and FMEA, Testing Procedure/Report, Electrical Analysis), and changes performed on CS 23 and 25 airplanes and CS 27 and 29 rotorcrafts.