

Enhanced modeling and experimental verification of a thermoelectric refrigerator unit considering the door opening effect

Original

Enhanced modeling and experimental verification of a thermoelectric refrigerator unit considering the door opening effect / DIAZ LONDONO, CESAR EDUARDO; Enescu, Diana; Ruiz, Fredy; Mazza, Andrea; Chicco, Gianfranco. - ELETTRONICO. - (2021), pp. 1-6. (Intervento presentato al convegno 56th International Universities Power Engineering Conference, UPEC 2021 tenutosi a Middlesbrough, United Kingdom nel 31 Aug.-3 Sept. 2021) [10.1109/UPEC50034.2021.9548219].

Availability:

This version is available at: 11583/2956463 since: 2022-05-28T12:18:59Z

Publisher:

Institute of Electrical and Electronics Engineers Inc.

Published

DOI:10.1109/UPEC50034.2021.9548219

Terms of use:

This article is made available under terms and conditions as specified in the corresponding bibliographic description in the repository

Publisher copyright

IEEE postprint/Author's Accepted Manuscript

©2021 IEEE. Personal use of this material is permitted. Permission from IEEE must be obtained for all other uses, in any current or future media, including reprinting/republishing this material for advertising or promotional purposes, creating new collecting works, for resale or lists, or reuse of any copyrighted component of this work in other works.

(Article begins on next page)

Enhanced Modeling and Experimental Verification of a ThermoElectric Refrigerator Unit Considering the Door Opening Effect

Cesar Diaz-Londono *Dipartimento Energia
Politecnico di Torino*
Torino, Italy

cesar.diazlondono@polito.it Diana Enescu *Electronics Telecommunications
and Energy Department*

Valahia University of Targoviste
Targoviste, Romania

diana.enescu@valahia.ro Fredy Ruiz *Dipartimento di Elettronica,
Informazione e Bioingegneria*
Politecnico di Milano
Milano, Italy

fredy.ruiz@polimi.it Andrea Mazza,
Gianfranco Chicco *Dipartimento Energia*
Politecnico di Torino
Torino, Italy
andrea.mazza@polito.it,
gianfranco.chicco@polito.it

Abstract—This paper introduces some novel aspects concerning the circuit-based modelling of ThermoElectric Refrigerators (TERs) used for the purpose of time-domain simulations. Starting from a previously published model, some enhancements have been introduced to represent with more details the point at which the temperature is monitored inside the TER compartment, and in particular to take into account the effects of door opening with different duration and in different conditions. The novel circuit model has been validated through experiments carried out on a real TER. In particular, a small-size TER has been used for the experiments. The advantages to consider a small-size unit is that the temperature variations following door opening are large and the identification of the suitable model and parameters becomes more challenging. The results show that the door opening effect can lead to a significant temperature transient, that can continue for a long term (hours) especially when more thermal loads are located in the TER compartment after door opening.

Index Terms—Thermoelectric refrigerator, experimental assessment, door opening, equivalent circuit, temperature transient, circuit-based model, thermal load, control.

I. INTRODUCTION

THE global demand for refrigeration (e.g., for food preservation, vaccine and medicine conservation, air-conditioning, and cooling of various electronic equipment) is constantly increasing. This contributes to the growth in electricity consumption and, if the technologies used are not “green” enough, higher CO₂ emissions negatively impact on the environment. The research on environment-friendly and energy-efficient technologies is in progress, and one of the

attractive topics that refer to the green energy conversion is the ThermoElectric Refrigerator (TER) technology. A common TER includes a ThermoElectric Cooler (TEC) device packaged by two ceramic plates, the finned heat sinks at both sides of TEC and an insulated compartment. The TEC device consists of a set of N-doped and P-doped semiconductors connected in series by metal strips. The TEC device operation is based on the Peltier effect that converts electricity into heat. Heat is transferred from its cold side to its hot side when a DC current supplies the TEC device [1]. In particular, the advantages of TEC devices are the utilisation of free carriers in place of the refrigerant, without harmful environmental effects, simple design, operation in any position, light-weight, high reliability, low vibrations, noiseless operation, absence of moving parts leading to less maintenance needs, temperature stability, operation in severe environments, controllability to within $\pm 0.1^\circ\text{C}$, small size [2], [3], and the possibility of keeping the temperature gradients with low energy consumption and affordable costs [4]. The major drawbacks in a TEC device are maintaining adequate temperature gradients and operating at high efficiency with respect to other refrigerators [5]. The TER unit receives power from the supply, and its control system operates the unit based on determined conditions inside the compartment. Heat is released to the environment to keep the desired temperature inside the inner compartment (Fig. 1).

Precise temperature control is necessary for foodstuff preservation. It is possible thanks to the feedback control of electric current applied to the TEC, varying its cooling

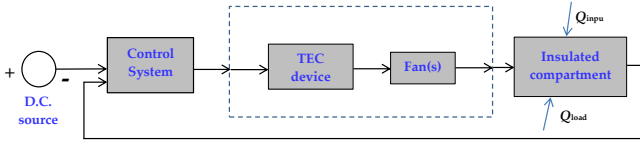

Fig. 1. Block scheme of a TER unit

power [2]. Standard commercial TERs contain on/off temperature controllers, which are cheaper and easier to install than continuous controllers. This controller acts on the voltage supplied to the TEC, based in the internal temperature of the TER, that is set between two set-points (upper and lower) [6], [7]. During the “on” cycle, the DC source powers the TEC with maximum voltage and switches it on. The TEC remains supplied until the interior temperature reaches the lower set-point. At this limit, the voltage is set to zero, and the TEC device is switched off [8]. The TEC remains switched off until the interior temperature reaches the upper set-point, and the cycle starts again [6]. A drawback of this control system is that, when the TEC devices are supplied with the maximum voltage the temperature difference of the TEC modules is maximum, leading to a growth of the electric power consumption of the TER, and eventually to a reduction of TER efficiency. Another drawback is that, when the TEC modules are switched off, a significant amount of heat at the hot side of the TEC returns into the TER, forming a thermal bridge.

The TER unit is considered a flexible technology with a long operational lifetime, being incorporated in a management system of electrical demand. Its operation takes place within an operating temperature range [9]. The TER unit is described by the thermal capacity, which provides thermal inertia. The thermal inertia represents the TER unit ability to store or release heat. Furthermore, thermal inertia gives the possibility to switch off the TER for a determined period. At the same time, its inner temperature is kept into an appropriate range to conserve the perishable foods or other contents. The TER unit is considered as a thermostatic load and is included in the equipment category that can implement demand side management strategies [10]. While the general characteristics of the TER operation have been studied by using numerical models, also with optimisations considering the size and parameters of the TER components, experimental studies aimed at understanding the TER operation in variable conditions are still limited. More insights are needed on how to represent the ambient temperature as a parameter that affects the TER operation in specific conditions, e.g., with door opening [11].

In a previous contribution [12], the TER has been modelled in a framework based on parameter identification from experimental results. A dedicated model has been proposed, validated, and used to promote the TER as a device able to provide operational flexibility. In that contribution, door opening was not explicitly modelled. However, in the real case, particular conditions occur when the door is open and the internal part of the TER is exposed to the ambient temperature until the door is closed again. This paper presents an extension of the model proposed in [12], including additional parameters

that represent the effect of the temperature difference between the internal part of the TER and the ambient when the door is open. An experimental evaluation is carried out for the different duration of the door opening to indicate the change in the TER consumption that occurs in these conditions. A small TER is used for the experiments to enhance the visibility of the transient behaviour of the TER under these circumstances. Moreover, the model is extended to consider the point in which the internal temperature is measured, as the measurement point could be at some distance from the TEC terminals. The extension of the model and the experimental verification of the parameters are the specific novelties of this paper.

The next sections of the paper are organised as follows. Section II presents the model enhancements. Section III shows the experimental setup and the results. Finally, the conclusions of the paper are presented in Section IV.

II. THERMOELECTRIC REFRIGERATOR UNIT MODELLING

The thermal operation model of the TEC module included in a TER unit is presented in Eq. (1) and Eq. (2). Here the heat flow rate \dot{Q}_c is absorbed by the cold side of the TEC, and the heat flow rate \dot{Q}_h is released from the hot side of the TEC to the ambient.

$$\dot{Q}_c = \alpha T_c I_p - \frac{1}{2} I_p^2 R_p - K_p \Delta T, \quad (1)$$

$$\dot{Q}_h = \alpha T_h I_p + \frac{1}{2} I_p^2 R_p - K_p \Delta T, \quad (2)$$

where $\Delta T = T_h - T_c$, α is the Seebeck coefficient, T_c and T_h are the cold and hot TEC temperatures, respectively, I_p and R_p are the Peltier electric current and resistance, respectively, and K_p is the Peltier thermal conductance. Both heat flows depend on the current I_p . Fig. 2 shows an electrical scheme of the TEC module. The electric power is:

$$P = V_{in} I_p, \quad (3)$$

while the current I_p is determined by the difference between the input voltage V_{in} and the Seebeck effect voltage V_α :

$$V_{in} - V_\alpha = I_p R_p. \quad (4)$$

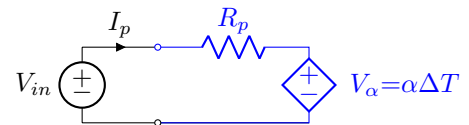

Fig. 2. Electrical TEC module scheme.

A. TER Equivalent Circuit

Fig. 3 shows the equivalent circuit of a TER. The base model corresponds to the elements shown in black in the figure (considering the TEC module). The TEC module extracts heat from the internal compartment at a rate \dot{Q}_c . The outer environment of the TER (which includes the external plate and the heat sink) at temperature T_h is modelled with the thermal capacitance C_{out} . The heat flow \dot{Q}_h coming

from the TEC module is dissipated to the ambient through the thermal resistance R_{out} . Moreover, the thermal resistance R_{TR} and the thermal capacity C_{TR} are the equivalent parameters from the internal measurement point at temperature T_{in} and the ambient temperature T_{amb} . The presence of thermal loads inside the compartment (for example, food stored) is modelled with the thermal capacitance C_d and the thermal resistance R_d . In the study carried out in this paper, the compartment is empty or contains different numbers of bottles of water. Table I presents the parameter values of the base model defined in [12], where the TER internal compartment temperature was assumed as the TEC temperature T_c .

TABLE I
PARAMETER VALUES FOR THE INITIAL TER MODEL [12]

Parameter	Value	Units
α	0.0779	V/K
R_p	2.53	Ω
K_p	0.134	W/K
C_{TR}	6300	J/K
R_{TR}	0.362	W/K
C_{out}	4500	J/K
R_{out}	0.072	W/K

B. Model Enhancements to Include More Internal Points

Fig. 3 depicts the enhancements of the TER model. This circuit is an extended version of the one proposed in [12]. The extensions are shown in red in the figure. The ambient temperature T_{amb} and the internal temperature T_{in} are measured by using appropriate sensors, while the temperatures that correspond to the other nodes are not measured directly. The ambient temperature T_{amb} is generally variable in time.

The representation of the internal volume of the TER has been formulated in [12] by using a few components of the equivalent circuit with the related parameters. In this paper, the number of equivalent circuit components has been extended to make the circuit resemble much more the contents of the physical system. In particular, two points are considered to model the internal part of the TER from the cooling side of the TEC to the external ambient (Fig. 3). The first point refers to the equivalent circuit that considers the TER contents (for example, bottles of water), and is connected to the cooling side through the thermal resistance R_{cd} . The second point refers to the temperature sensor location (T_{in}) and is connected to R_{cd} through the thermal resistance R_{dn} . In addition, the thermal capacitance with capacity C_{dn} has been added for modelling the temperature transients more effectively.

C. Model Enhancements to Include the Door Opening Effect

The basic TER model proposed in [12] represents with reasonable accuracy the thermal behaviour of the TER when the door is closed, also following possible changes in the external temperature. However, after some experimental verifications, the model has resulted insufficiently accurate for representing the thermal behaviour of the TER after the door opening. For this purpose, the model has been extended to include the representation of the effect of the ambient temperature

to which the compartment is suddenly subject after the door opening, until the door is closed again.

Some literature references have considered the modelling of the effect of door opening for different types of refrigerators, even though no information has been found for the specific case of TER. The information about how often the refrigerator doors are opened by consumers are reported in [13] for France, estimating that 19% of consumers open the doors less than 10 times/day, 38% open the doors more than 20 times/day, while 43% open the doors 10-20 times/day. For Europe, in [14] it is estimated that the consumers opened the door of the refrigerator only 8.2 times/day. In warmer climates like in Malaysia [15], it is estimated that 8% of the consumers open the doors of their refrigerators less than 10 times/day, 73% open the doors 10-20 times/day, while 19% open the doors more than 20 times/day.

The experimental tests carried out in [16] for a household refrigerator/freezer under full of food condition highlight the effects of the door opening at an ambient temperature (25°C), showing higher energy consumption of 10.5% to 14% than in closed door conditions. In [17] an increase in energy consumption from 5% to 10% for each door opening is indicated on the basis of 50 door openings for 5 s each for different refrigerators, considering 15°C of ambient temperature.

Concerning the equivalent circuits to be considered for modelling door opening, the literature offers limited emphasis. A solution is the representation of this effect by adding thermal resistances in parallel to existing resistances [18], for reducing the overall resistance and allowing the internal temperature to grow more easily.

In the approach presented in this paper, starting from the basic TER model, the internal nodes that contain a capacity have been connected to the external ambient through the two resistances denoted as R_{door1} and R_{door2} , as shown in Fig. 3. In this way, the effect of these resistances is to increase the heat flow allowing a rapid rise in temperature in the two related nodes, followed by a temperature transient in which the combined effect of the resistances and capacitances in the model enables us to reproduce with acceptable accuracy the experimental results.

III. EXPERIMENTAL RESULTS

A. System Data

To calculate the enhanced model parameters, i.e., R_{door1} , R_{door2} , R_{cd} , R_{dn} , and C_{dn} , different experiments were performed in a commercial TER.

The internal TER capacity is 42 l and contains an insulation compartment with the bottom and upper thickness of 0.06 m, while the lateral thickness is 0.04 m. The device has two air fans, one is inside, the other one is external, mounted on the hot side heat sink. The unit has a rated power of 50 W. Moreover, the hardware implementation and components for measuring and controlling the TER are presented in [12].

Internal T_{in} and ambient T_{amb} temperatures were registered as well as the voltage V_{in} and the current I_p for computing the electric power P absorbed by the TER. The sample time is 1 s.

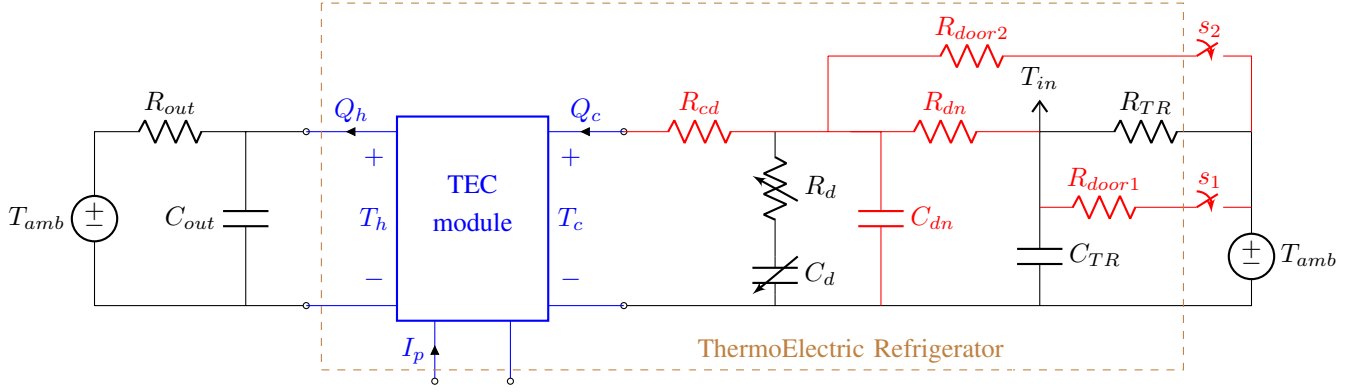

Fig. 3. TER scheme (Enhancements of the TER model in red).

Therefore, six different measurement sets were recorded considering different conditions for the door opening. The temperature set-points used in the experiments are between 9.8°C and 10.1°C . The experiments are divided into two sets: i) without introducing thermal load; and, ii) introducing thermal load.

Each experiment of the set without introducing thermal load presents three instants for door opening. In these experiments, the door remains open 10 s, 20 s, and 30 s in the different instants. The difference between these experiments refers to the internal temperature at opening the door, i.e.,

- Experiment 1: opening the door at 10.0°C (see Fig. 4).
- Experiment 2: opening the door at 10.2°C (see Fig. 5).
- Experiment 3: opening the door at 10.4°C (see Fig. 6).

The experiments for the set introducing thermal load consider different loads and different times for door opening, i.e.,

- Experiment 4: introducing one bottle of water and leaving the door open for 10 s (see Fig. 7).
- Experiment 5: introducing three bottles of water and leaving the door open for 20 s (see Fig. 8).
- Experiment 6: introducing two bottles of water in different time instants and leaving the door open for 10 s in the first instant and 20 s in the second instant. This experiment starts with one bottle inside (see Fig. 9).

B. Model Tuning

With the purpose of validating the enhanced model, simulations of all experiments are developed and compared with experimental data.

The model simulation (Fig. 3) is performed in MATLAB software using *Simulink*. It has a *Peltier Device* block that fulfills Eq. (1) and Eq. (2), the thermal resistances and capacitances are modeled with *Thermal Resistance* and *Thermal Mass* blocks respectively, while the T_{amb} source is modelled with a *Controlled Temperature Source*. These blocks are used taking into account the *Simscape* library. Moreover, the switch s_1 represents the initial transient and remains open 10% of the s_2 time; whereas, the switch s_2 represents the heat lost when opening the door.

The model parameters are calculated with a heuristic method by minimizing the error between the experimental data

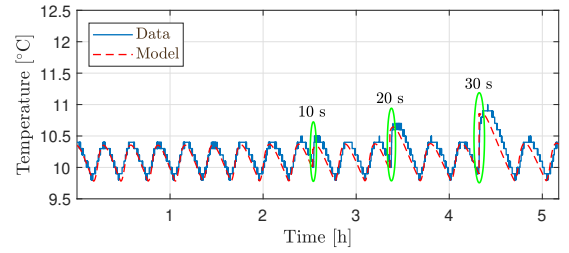

(a) Temperature.

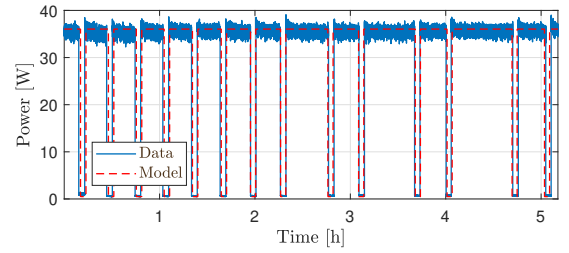

(b) Power.

Fig. 4. Experiment 1. Door opening for 10 s, 20 s, and 30 s.

and the model response. In particular, the parameters presented in Table II have the same value for all experiments. Likewise, Table III shows the R_{door2} values for all the experiments.

TABLE II
FIXED VALUES FOR THE TER MODEL

Parameter	Value	Units
R_{dn}	0.066	W/K
C_{dn}	4400	J/K
R_{cd}	0.033	W/K
R_{door1}	0.008	W/K

Considering the first set of experiments (i.e., without load), it is noticed that the value of R_{door2} depends on the experiment (*exp*) and on the time the door is open. Therefore, from the different values of R_{door2} presented in the Table III, it is observed that relation of them is given by:

$$R_{door2,exp,N_t} = A(1 + (N_t - 1)B), \quad (5)$$

where $N_t = \{1, 2, 3\}$ depending on the time the door is open $\{10 \text{ s}, 20 \text{ s}, 30 \text{ s}\}$. Table IV shows the parameters A and B .

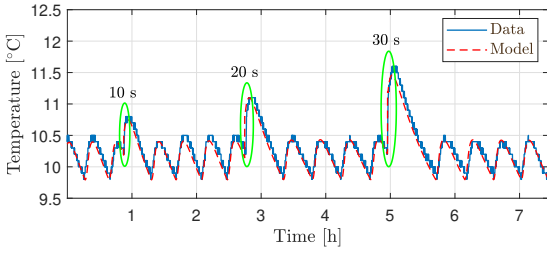

(a) Temperature.

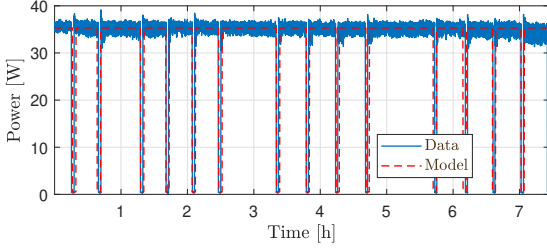

(b) Power.

Fig. 5. Experiment 2. Door opening for 10 s, 20 s, and 30 s.

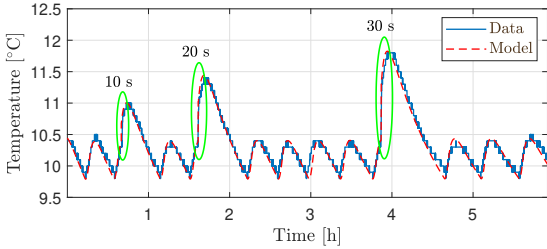

(a) Temperature.

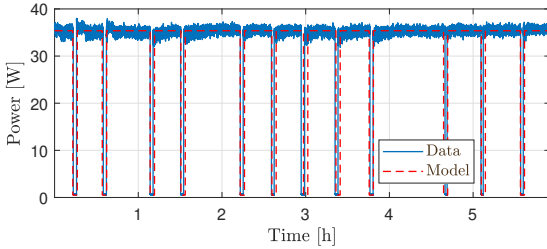

(b) Power.

Fig. 6. Experiment 3. Door opening for 10 s, 20 s, and 30 s.

Fig. 4, Fig. 5, and Fig. 6 present the temperature and the power responses for experiments 1, 2, and 3. The experimental data can be seen in the blue line and the model response in red dashed-line. For assessing the effectiveness of the results, two classical error indicators have been computed, namely, the root mean square error (RMSE) and the maximum absolute error (MAXAE). Table V shows the results. It can be seen that the temperature errors are relatively limited in all cases, while the MAXAE reaches values as high as the TER power, because for one or a few time steps the duty cycle is not reproduced precisely. The MAXAE results have been indicated to show that under these conditions the MAXAE indicator is poorly appropriate to represent the results.

Considering the second set of experiments (i.e., with thermal load), the estimated values of R_d and C_d are shown in

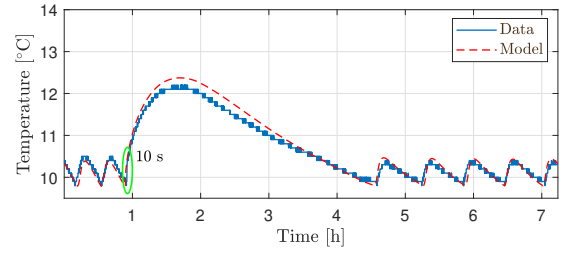

(a) Temperature.

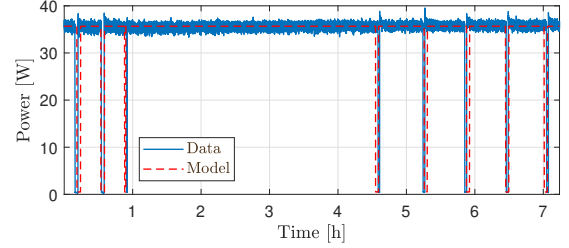

(b) Power.

Fig. 7. Experiment 4. Door opening and introducing thermal load.

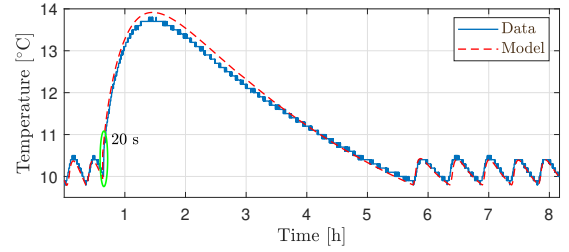

(a) Temperature.

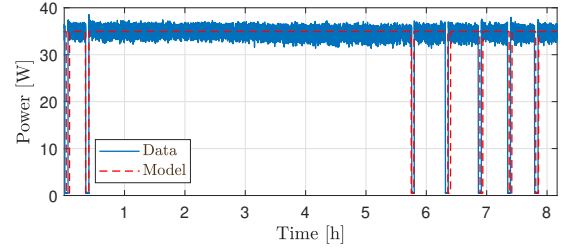

(b) Power.

Fig. 8. Experiment 5. Door opening and introducing thermal load.

Table VI.

Fig. 7, Fig. 8, and Fig. 9 present the temperature and the power responses for experiments 4, 5, and 6. Again, the experimental data are shown with the blue line and the model response with the red dashed line. In these cases, the introduction of additional thermal load (bottle of water) creates a more extended temperature transient, in which the duration of the “on” state becomes quite long, up to a few hours. This fact indicates clearly that for small TER compartments the effect of door opening is remarkably significant.

IV. CONCLUSIONS

A novel equivalent circuit of the TER has been proposed to extend a previous TER model and incorporate additional parameters that allow taking into account the effect of door

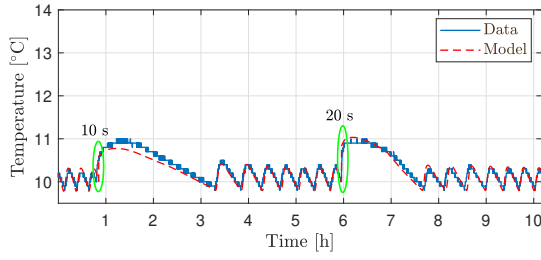

(a) Temperature.

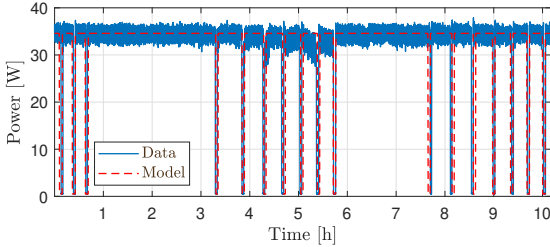

(b) Power.

Fig. 9. Experiment 6. Door opening and introducing thermal load.

TABLE III
 R_{door2} VALUES FOR THE EXPERIMENTS

Exper.	R_{door2} [W/K] ($t_2 = 10$ s)	R_{door2} [W/K] ($t_2 = 20$ s)	R_{door2} [W/K] ($t_2 = 30$ s)
1	0.0360	0.0558	0.0756
2	0.0240	0.0372	0.0504
3	0.0270	0.0351	0.0432
4	0.0300	-	-
5	-	0.0465	-
6	0.0300	0.0465	-

opening and the actual location of the measurement point inside the cabinet. The effectiveness of the model has been verified through experimental measurements, along with the estimation of the related circuit parameters. The TER used for the experimental tests is of small size, enabling us to test the model in real cases in which the door opening has a remarkable effect on the temperature transients. The results obtained indicate that the proposed model is accurate in reproducing the transient behaviour of the TER for different door opening duration. The contribution of this paper enables us constructing an useful simulation model that can be applied for representing the TER behaviour for each individual refrigerator, from which it is possible to assess the aggregate behaviour of a number of TERs in which door opening may occur randomly in time and duration. Future work will analyse the impact of the transient conditions on the assessment of the flexibility that can be obtained by using an aggregation of TERs for the provision of energy services.

REFERENCES

- [1] D.M. Rowe, "Thermoelectrics handbook—macro to nano", CRC Press Taylor&Francis, BocaRaton, FL, 2006.
- [2] P.K. Bansal and A. Martin, "Comparative study of vapour compression, thermoelectric and absorption refrigerators", Int J Energy Res, vol. 24(2), pp. 93–107, 2000.
- [3] D. Zhao and G. Tan, "A review of thermoelectric cooling: materials, modeling and applications", Appl Therm Eng, vol. 66, pp. 15–24, 2014.

TABLE IV
PARAMETERS EXPLAINING THE RESISTANCE VARIATIONS IN EQ. (5)

Experiment	A	B
1	0.036	0.55
2	0.024	0.55
3	0.027	0.30

TABLE V
ERROR MEASURES FOR THE TER MODEL

Exper.	Temperature T_{in}		Power P	
	RMSE [°C]	MAXAE [°C]	RMSE [W]	MAXAE [W]
1	0.11	0.76	8.05	35.55
2	0.10	0.80	8.18	35.01
3	0.09	0.68	7.81	34.84
4	0.15	0.51	7.70	35.32
5	0.11	0.65	5.15	34.48
6	0.11	0.65	8.81	34.08
Mean	0.11	0.68	7.62	34.88

- [4] B. Abderezak, R. K. Dreepaul, K. Busawon and D. Chabane, "Experimental Characterisation of a Novel Configuration of Thermoelectric Refrigerator with Integrated Finned Heat Pipes", Int J Refrig, 2021.
- [5] D. Enescu and E.O. Virjoghe, "A review on thermoelectric cooling parameters and performance", Renew. Sust. Energ. Rev., vol. 38, pp. 903-916, 2014.
- [6] D. Astrain, A. Martínez, J. Gorraiz, A. Rodríguez and G. Pérez, "Computational study on temperature control systems for thermoelectric refrigerators", J Electron Mater vol. 41, pp.1081–1090, 2012.
- [7] A. Martínez, D. Astrain, A. Rodríguez, and G. Pérez, "Reduction in the electric power consumption of a thermoelectric refrigerator by experimental optimisation of the temperature controller", J Electron Mater vol. 42, pp. 1499–1503, 2013.
- [8] A. Martinez, D. Astrain, A. Rodriguez, and P. Aranguren, "Advanced computational model for Peltier effect-based refrigerators", Appl. Therm. Eng., vol. 95, pp.339–347, 2016.
- [9] S. Riffat, S. Omer and X. Ma, "A Novel thermoelectric refrigeration system employing heat pipes and a phase change material: an experimental investigation", Renew Energy vol. 23, pp.313–23, 2001.
- [10] C. Diaz-Londono, D. Enescu, A. Mazza and F. Ruiz, "Characterisation and Flexibility of a ThermoElectric Refrigeration Unit", the 54th International Universities Power Engineering Conference (UPEC), 3-6 Sept. 2019, Bucharest, Romania.
- [11] A. Çağlar, "Optimisation of operational conditions for a thermoelectric refrigerator and its performance analysis at optimum conditions", Int J Refrig, vol. 96, pp. 70-77, 2018.
- [12] C. Diaz-Londono, D. Enescu, F. Ruiz and A. Mazza, "Experimental modeling and aggregation strategy for thermoelectric refrigeration units as flexible loads", Appl. Energy, vol.272, pp.1-17, 115065, 2020.
- [13] O. Laguerre, E. Derens, and B. Palagos, "Study of domestic refrigerator temperature and analysis of factors affecting temperature: a French survey", Int. J. Refrig., vol.25, pp. 653–659, 2002.
- [14] S. Thomas, "Erhebung des Verbraucherverhaltens bei der Lagerung verderblicher" ("Survey of consumer behavior when storing perishable items", in German), Schriftenreihe der Haushaltstechnik, Bonn, Germany, 2007.
- [15] S. Rahman, N. Mohd Sidik, M.H.J. Hassan, T. Mohd Rom and I. Jauhari, "Temperature performance and usage conditions of domestic refrigerator-freezers in Malaysia", Trans. Hong Kong Inst. Eng., vol.12, pp.30–35, 2005.
- [16] P.K. Bansal, "Energy efficiency test standards for household refrigerators", APEC Symposium on Domestic Refrigeration Appliances, 2000.
- [17] D.Y. Liu, W.R. Chang and J.Y. Lin, "Performance comparison with effect of door opening on variable and fixed frequency refrigerators/freezers". Applied Thermal Engineering, 24, 2281-2292, 2004.
- [18] W. Terrell Jr., "Energy Requirements of Refrigerators Due to Door Opening Conditions" (2006). International Refrigeration and Air Conditioning Conference. Paper 836.

TABLE VI
THERMAL LOAD VALUES

Exper.	R_d [W/K] ($t_{door} = 10$ s)	C_d [J/K]	R_d [W/K] ($t_{door} = 20$ s)	C_d [J/K]
4	0.580	9450	-	-
5	0.308	20400	-	-
6	0.785	14800	0.810	9850