

Maintenance Activity, Reliability, Availability, and Related Energy Losses in Ten Operating Photovoltaic Systems up to 1.8 MW

Original

Maintenance Activity, Reliability, Availability, and Related Energy Losses in Ten Operating Photovoltaic Systems up to 1.8 MW / Spertino, F.; Chiodo, E.; Ciocia, A.; Malgaroli, G.; Ratclif, A.. - In: IEEE TRANSACTIONS ON INDUSTRY APPLICATIONS. - ISSN 0093-9994. - ELETTRONICO. - 57:1(2021), pp. 83-93. [10.1109/TIA.2020.3031547]

Availability:

This version is available at: 11583/2865132 since: 2021-01-22T10:37:25Z

Publisher:

Institute of Electrical and Electronics Engineers Inc.

Published

DOI:10.1109/TIA.2020.3031547

Terms of use:

This article is made available under terms and conditions as specified in the corresponding bibliographic description in the repository

Publisher copyright

(Article begins on next page)

Maintenance Activity, Reliability, Availability and Related Energy Losses in Ten Operating Photovoltaic Systems up to 1.8 MW

Filippo Spertino¹, Senior Member, IEEE, Elio Chiodo², Senior Member, IEEE, Alessandro Ciocia¹, Member, IEEE, Gabriele Malgaroli¹, Member, IEEE, Alessandro Ratclif¹

Abstract — In general, Photovoltaic (PV) plants do not include components with moving parts and, as a consequence, they are wrongly considered maintenance-free. Thus, the present work presents a maintenance, reliability and availability analysis of ten PV systems, with different inverter configurations, in the context of the intermittent RES systems, including the wind farms. The first part of the analysis consists of the evaluation of reliability using failure rates from literature. In the second part, these results are compared with data obtained from industrial maintenance reports in the years 2016 - 2018. Finally, the yearly energy losses and the availability of each PV plant are assessed.

Keywords— photovoltaic systems, reliability, maintenance engineering, power system faults, availability.

NOMENCLATURE

Symbol	Description
A	Availability Function
E_{PV}	Expected PV generation
H_g	Global irradiation
m_i	# of identical components
$MTBF$	Mean Time Between Failures
$MTTF$	Mean Time To Failure
$MTTR$	Mean Time To Repair
N_p	# of parallel strings
N_s	# of series modules per string
Pr	Occurrence probability of an event
PR	Performance Ratio
R	Reliability Function
R_{sys}	Reliability of the system
t	Time Instant
S_{PV}	PV surface area
Δt	Time Interval
λ	Failure Rate
η_{STC}	PV modules Efficiency at STC
η_{deg}	Degradation efficiency

I. INTRODUCTION

In recent years, the new challenges in the energy sector consist of reducing the polluting emissions and, thus, the global warming. Moreover, the global energy demand is increasing due to factors like the urbanization process and the population growth. In this context, the adoption of Renewable Energy Sources (RES) is fundamental to satisfy the increasing energy demand meeting the actual

¹Dipartimento Energia “Galileo Ferraris”, Politecnico di Torino, Corso Duca degli Abruzzi 24, 10129 Torino, Italy, (e-mail: {filippo.spertino, alessandro.ciocia, gabriele.malgaroli, alessandro.ratclif}@polito.it)

²Dipartimento di Ingegneria Industriale, Università di Napoli Federico II, Napoli, Italy (email: elio.chiodo@unina.it)

environmental requirements. Among RES, solar PhotoVoltaic (PV) technology is the most important and reliable for electricity production with respect to wind parks, in which rotating Wind Turbines (WTs) are typically the weak point of energy conversion. Moreover, PV technology exhibits low installation, operation and maintenance costs in solar systems. It is based on solar energy, which has a worldwide distribution, it is clean and inexhaustible. In particular, the reliability of PV modules affects the reliability of the whole PV systems, being their most important components. Generally, the performance of PV generators is affected by factors like adverse operating conditions (high air temperature, low irradiance, bad weather conditions, etc.) or natural degradation of PV materials. These factors result in a reduction of PV production and they cannot be avoided. In addition, PV generators may fail due to issues in the design, transportation or operation stages. Therefore, a Reliability Analysis (RA) is fundamental for PV operator in order to evaluate the possible faults in a PV system, correctly estimating the generation of the plant.

In the power system domain, several papers investigate the reliability of the network in terms of global variable (for example by calculating the energy not supplied), both with multi-objective [1] and single-objective formulation [2]. Nevertheless, few papers in literature evaluate the reliability of PV generators at system level. At component level, [3] performs a long-term reliability analysis using Markov method. In [4], the reliability of the junction box of PV modules for a 1 GW database (operating outdoor) is investigated.

In [6] and [7], the degradation of PV modules and the reliability strictly connected to faults due to extreme climate conditions are evaluated. In [8], a novel set of risk indexes is identified to improve a traditional Risk Analysis of PV modules, based on Failure Mode Effect and Criticality Analysis. In [9] several Reliability Block Diagrams are proposed to evaluate the reliability of different topologies of PV generators. In [10], a RA is applied to five grid-connected PV plants, using a Fault Tree Analysis (FTA) to identify the most critical components of each plant. Moreover, the annual energy losses are estimated at system level and the individual contribution of each faulty component is assessed.

The present work improves the analysis presented in [10] for five PV plants and extends it to ten PV systems with different inverter configurations: centralized, string and multi-string converters are investigated. Moreover, the five added systems have PV generators ground-mounted, with respect to the rooftop PV arrays in [10]. In the first part of this work, a reliability analysis using failure rates from literature has been applied to other five PV plants with rated power from 1 MW to 1.8 MW. In particular, three failure rates have been considered for PV modules according to their technology (mono-crystalline silicon, m-Si, polycrystalline silicon, p-Si, or thin films). Moreover, a deep research in literature has been performed and new failure rates for the other components, different from [10], have been considered from more updated references.

In the second part of the work, industrial maintenance reports in the years 2016-2018 of other five PV plants with respect to [10] have been analyzed. These reports collect the main information of the maintenance activities for each plant: the start/end date of each action, its duration, its typology (corrective, preventive maintenance or monitoring), the involved equipment and a short description of the maintenance activity. Thus, this information has been sorted according to the involved component; then, the number of failures associated to each group of components and the average repair time have been estimated. Moreover, in case of failure, the duration of the maintenance in the reports permits to estimate the corresponding energy losses. Finally, the present paper provides additional information with respect to [10] by reporting the availability of the PV systems under analysis.

The next sections of the paper will be organized as follows. In section II, the models that perform the reliability analysis using data from literature are presented. Section III contains a description of the PV plants under analysis and section IV presents the results of the reliability analysis. Section V presents a comparison of the main reliability parameters with the other most important RES (wind power plants). Finally, section VI contains the conclusions.

II. RELIABILITY AND AVAILABILITY MODELS APPLIED TO PV PLANTS

A. Reliability and Availability theory

The reliability of an object (component, subsystem or system) is the ability to perform its functions for a specified time interval Δt under stated environmental and operating conditions [11]. However, in order to correctly assess the reliability of a device, the calculation of some parameters is required.

First, the Failure Rate (λ) is the forecasted number of times an object breaks in the time unit. In particular, it represents the probability that a component or a system fails in the unit of time and it is expressed in number of failures per time unit [12]. However, the failure rate is a function of time because it depends on the life stage of the component. The life cycle of a component can be divided into three stages: the burn-in period, the useful life and the wear-out period. Fig. 1 presents the typical evolution of failure rate with time (the “bathub curve”). Despite components are generally subject to stress tests, they may present undesirable failures (“early failures”) in their early life stage (the burn-in). These are caused by manufacturing or design defects that are not detected in the test phase. As a result, in this stage, the failure rate λ_B is high but it rapidly decreases with time because defective components are identified and discarded. Then, in the useful life period, the failure rate λ_{UL} is low and almost constant: in this case the probability that a device fails is due to random failures only. In the latter part of the curve (the wear-out), the failure rate λ_W increases as a result of component deterioration due to aging and usage [13]. The probabilistic model adopted in the present work assumes that components are working in their useful life period ($\lambda \approx \lambda_{UL}$): as a consequence, the failure rate can be assumed as a constant quantity.

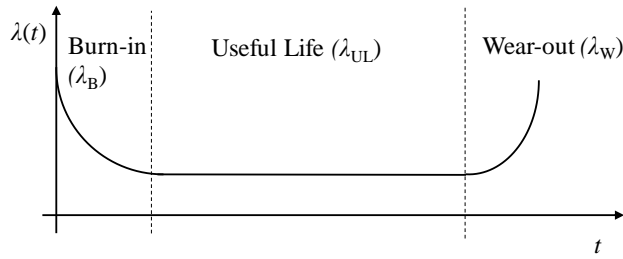

Fig. 1. Bathtub curve

In such condition, the reliability function $R(t)$ can be estimated in the following way:

$$R(t) = \exp(-\lambda t) \quad (1)$$

The component is assumed fully functional at the beginning of its life, resulting in $R(t=0)=1$. The profile of exponential reliability function over time is presented in Fig. 2. The failure rate is equal to the opposite of the derivative function in the origin with negative sign $R'(t=0)$, i.e. it corresponds to $-\tan(\alpha)$.

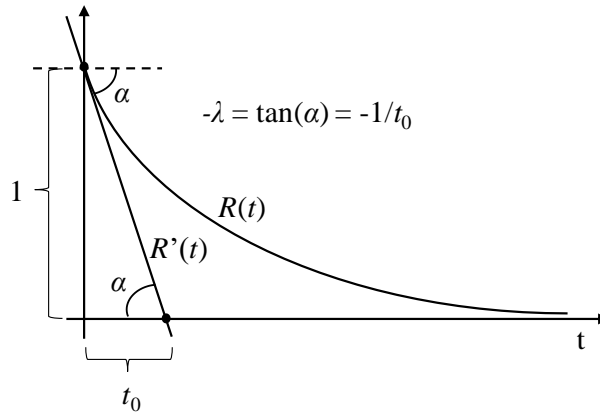

Fig. 2. Exponential reliability and its derivative function

The parameters commonly evaluated in reliability analysis are the Mean Time To Failure ($MTTF$) and the Mean Time To Repair ($MTTR$). The first quantity describes the expected time before failure of a component. This parameter can be estimated in case of non-repairable devices, describing the average time before the objects fail. In such condition, the components are, then, replaced by new ones because their replacement is preferred due to the lower costs and the time saving with respect to the repair of the devices.

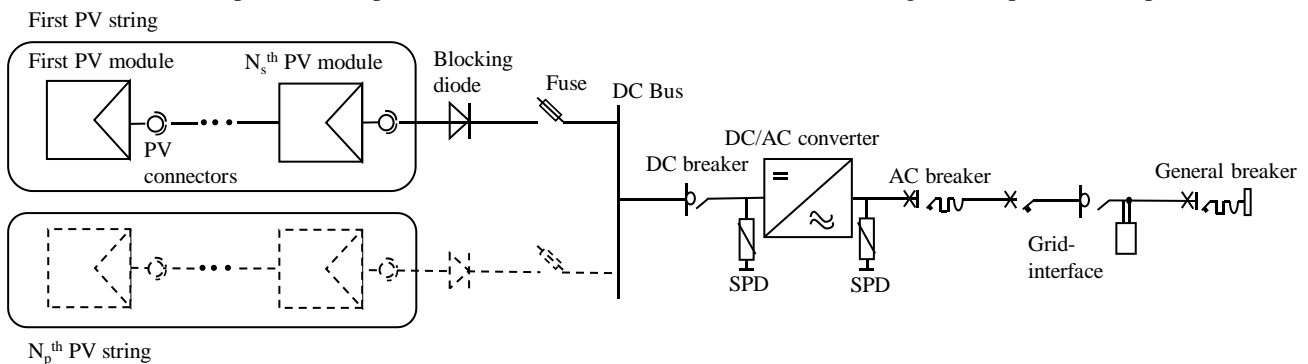

Fig. 3. Simplified scheme showing the main components of a PV system

On the contrary, for repairable components, i.e. their failure does not require a replacement of the device, the Mean Time Between Failures ($MTBF$) expresses the average time between two failures of repairable devices. These quantities provide information to compare the expected reliability of different systems. In general, the $MTTF$ and the $MTBF$ refer to different components but the $MTBF$ converges to the $MTTF$ when repairable components fail with the same failure mode. In this case, components are assumed to recover their full functionality after being repaired, i.e. the reliability function is unitary, and their failure rate is constant. This assumption is valid during the useful life phase of each component.

The $MTTF$ can be evaluated starting from the reliability function by the following integral relationship:

$$MTTF = \int_0^{\infty} R(t)dt \quad (2)$$

A correct evaluation of the *MTTF* is required in order to maximize the schedule of preventive maintenance, improving the productivity of the component without performing not required maintenance operations. Assuming that the components are in their useful life period, i.e. the failure rate is constant, the *MTTF* can be evaluated as $1/\lambda$.

The Mean Time To Repair (*MTTR*) is the average time required to troubleshoot and repair a faulty component, including any testing time to check that it is fully functional again [15]. The *MTTR* is affected by several factors like the rapidity of the diagnosis; the availability of replacement components in stock and the logistic delays due to their transport; the complexity of maintenance. This quantity has to be minimized in order to improve the response of the system in case of failures. Eventually, actions aiming to minimize the *MTTR* may consist of increasing the availability of replacement components in stock and, thus, being able to replace faulty components more rapidly. Moreover, the down time between a failure and its detection may be reduced by scheduling a frequent check of devices with the highest failure rates [16] [17].

A parameter that is linked to the reliability and the maintainability of a system is its availability function $A(t)$. This quantity indicates the probability that the system is capable of performing its function when it is required [18]. In particular, it is the ratio between the uptime and the expected operation time of the system. The uptime is its effective operation time, not including the downtime due to maintenance, logistic, administrative delays and other sources of underperformance. The availability function ranges between 0 and 100% (the plant is fully operational); moreover, it can be calculated in a simplified way as [18]:

$$A(t) = MTTF / (MTTF + MTTR) \quad (3)$$

This simplification is valid if the operating time of the system is at least 4 times or 5 times larger than its *MTTR*.

B. Description of the main components of PV plants and their failure rates

PV plants include a large amount of supporting equipment, which is required to balance the system and make it fully operational. Moreover, PV systems are typically modular: thus, these devices can be added to the plant or removed for repairs without relevant disruption of their infrastructure. Several layouts and configurations of PV plants are possible [19]: as a consequence, each plant may have a different number of components, resulting in different schemes of the system. Thus, it is not possible to identify a single scheme, which describes each type of PV plant.

However, the FTA approach, which is described in Section II.C, requires a generic description of the main components in the PV system. Thus, a simple standard single-line diagram can be identified to perform the FTA. Fig. 3 shows the scheme adopted in the present work: it describes with good approximation the sequence and operation of the main components of a generic PV plant. The undesired event of the FTA is the loss of production of the PV plant due to the failure or the breakage of a component. In this case, the simplified scheme of the plant shows that all the components are connected in cascade: as a consequence, the undesired event may be due to the failure of a diode or a fuse, connected to a single string, or the failure of breakers like the AC breaker or the general breaker of the whole plant. Moreover, the loss of productivity due to the electric mismatch between PV modules or due to low irradiance are not taken into account because these conditions are not caused by a faulty component of the plant.

In the present paper, the PV plants consist of the electrical components described in [10], while support frames, video surveillance, etc. are not included. Table I reports the failure rates corresponding to each group of devices. This research paper examines all the above described components. However, other devices are located in a PV system, like Surge Protection Devices (SPDs) and the energy meter. The SPDs protect PV arrays against lightning surge voltages and they are connected in parallel to the arrays to be protected.

TABLE I. FAILURE RATES FROM LITERATURE

Components	Failure Rates (failures/hour)	Reference
PV modules	$3.1 \cdot 10^{-7}$ (p-Si)	[20]
	$1.5 \cdot 10^{-8}$ (m-Si)	[21]
	$2.4 \cdot 10^{-10}$ (thin films)	[21]
Connectors	$5.6 \cdot 10^{-9}$	[21]
Fuses	$1.8 \cdot 10^{-6}$	[21]
Diodes	$1.2 \cdot 10^{-9}$	[22]
DC breakers	$3.8 \cdot 10^{-7}$	[23]
DC/AC converters	$1.3 \cdot 10^{-4}$ (centralized)	[22]
	$1.3 \cdot 10^{-5}$ (string/multi-string)	[21]
AC breakers	$8.5 \cdot 10^{-6}$	[23]
Grid interface	$3.4 \cdot 10^{-6}$	[23]
General AC breaker	$3.8 \cdot 10^{-7}$	[23]

On the contrary, the energy meter monitors the energy exchange with the AC grid, improving the energy management and, thus, increasing the self-sufficiency of the system. However, if these components fail, they do not carry out their function but this situation does not result in the undesired event of this analysis (loss of PV production).

C. Fault-tree analysis of PV plants

The FTA is a diagrammatic analytical technique that is, generally, adopted in RA: the goal of FTA is to improve the reliability of a system, reducing its global probability of failure and, thus, its costs. In particular, it identifies the failures of components and their possible combinations resulting in the undesired event (top event) of the analysis [24, 25]. Then, the FTA estimates the probability of occurrence of the top event in the operating conditions of the system.

The top event of the FTA may consist of the failure or the breakage of a component, resulting in a faulty operation of the system. This event needs to be properly selected in order to guarantee the effectiveness of the method. In the present work, the top event is the loss of PV production [10]; however, the effects due to the natural degradation of PV production during time [26] are not taken into account. In fact, these effects are considered in the feasibility study of a PV plant.

In this case, the failure of an element leads to the failure of the whole system (top event); moreover, failure events are assumed independent from each other. This means that the events are not mutually exclusive, i.e. the failure of a component cannot exclude the fault of another device. Moreover, the present analysis does not include failures due to design or installation errors of the components (each device is assumed properly designed and installed). Finally, the FTA is performed supposing the components of the system as repairable ones; the *MTTF* is assumed equal to *MTBF* and it is evaluated according to [27].

D. Quantitative estimation of PV reliability

The reliability is estimated starting from the configuration of the fault tree presented in the previous subsection. The relationships between the components failures have to be converted into a Boolean expression using the logic gates. This operation is required to identify the Minimal Cut Sets (MCSs) of the system: these sets represent the smallest combinations of basic events resulting in the top event [28]. The fault tree used in this work [10] shows that all the events are connected with OR gates, meaning that each basic event causes the occurrence of the top event. As a consequence, the top event will be equal to the Boolean sum of 9 MCSs, which correspond to the basic events:

$$Top\ Event = F1 + F2 + \dots + F9 \quad (4)$$

Then, from probabilistic theory, the occurrence probability of top event can be calculated in the following way:

$$Pr(Top\ Event) = Pr(F1 + F2 + \dots + F9) \quad (5)$$

As a consequence, the reliability of the system R_{sys} can be calculated starting from the reliability associated to each basic event according to (6):

$$R_{sys} = R(Top\ Event) = R(F1 + F2 + \dots + F9) = R(F1) \cdot R(F2) \cdot R(F9) \quad (6)$$

The reliability of each event, which corresponds to the reliability of each component of the PV plant, is calculated starting from (1). In fact, eq. (1) permits to evaluate the reliability of a single component but a complex system includes many identical components of the same typology. In this case, the reliability R_i associated to a specific type of component is calculated in the following way [27]:

$$R_i(t) = \exp(-m_i \cdot \lambda_i \cdot t) \quad (7)$$

where m_i is the number of identical components in the system, λ_i is the failure rate for this type of component and t is the time of the analysis, expressed in hours. Finally, the reliability of the system R_{sys} , which is the lowest one with respect to the reliability of its components, is evaluated as follows:

$$R_{sys}(t) = \exp(-t \sum_{i=1}^n m_i \cdot \lambda_i) \quad (8)$$

In the present analysis, the PV plants are supposed operating for an average time of 12 h per day, which corresponds to the average number of light-hours per day over a year.

III. DESCRIPTION OF THE PV PLANTS UNDER ANALYSIS

In the first part of the paper, the reliability of ten PV plants is evaluated using the technical datasheets of components in the systems and failure rates from literature. Then, the reliability of PV plants is evaluated thanks to maintenance reports and monitoring data in the years 2016-2017 (systems from #1 to #5) and 2016-2018 (from #6 to #10). Finally, the annual energy losses and the availability are estimated at system level. The main characteristics of the PV plants under analysis are summarized in Table II. In particular, the PV systems under analysis are installed in Northern Italy and have comparable life (they started operating in the years 2009-2012). However, they have different rated (nominal) powers, ranging from 50 kW to 1.8 MW, and, thus, different number of components in their systems. The PV modules of these ten systems belong to various technologies (m-Si, p-Si and thin films). In particular, plant #2 consists of thin films PV modules (rated power = about 73 W), while plant #4 includes m-Si (245 W) and p-Si modules (230 W). The other plants consist of p-Si PV modules, with a rated power ranging between 220 W and 240 W. Furthermore, the systems from #6 to #10 have ground-mounted PV generators with lower thermal loads (Fig. 4), while the PV arrays are placed on rooftop in the systems from #1 to #5.

TABLE II. MAIN CHARACTERISTICS OF THE PV PLANTS UNDER ANALYSIS

Plant	#1	#2	#3	#4	#5	#6	#7	#8	#9	#10
Nominal power (kW)	50	150	260	550	1000	1000	1000	1000	1800	1800
Installation year	2011	2009	2011	2012	2011	2011	2011	2011	2011	2011
PV technology	p-Si	Thin films	p-Si	m-Si/p-Si	p-Si	p-Si	p-Si	p-Si	p-Si	p-Si
Rated power of PV modules (W)	230	72.5	230	245/230	230/240	230	230	230	220/230	220/230
PV installation	Roof	Roof	Roof	Roof	Roof	Ground	Ground	Ground	Ground	Ground
Converters configuration	String	String/ Multi-string	String/ Multi-string	String/ Multi-string	String/ Multi-string	Centralized	Centralized	Centralized	String	String



Fig. 4. PV generators of one of the ground-mounted systems under analysis

Regarding the DC/AC converters configurations, PV plants #1, #9 and #10 include string inverters (with only one Maximum Power Point Tracker, MPPT). In particular, plant #1 consists of five string inverters (rated power = 10 kW), while plants #9 and #10 include 134 and 132 converters, respectively (output power = 13 kW). On the contrary, PV arrays in plants #6, #7 and #8 are connected to centralized inverters with high capacity (500 kW for inverters in plant #6 and 350 kW for the others). The other plants include string and multi-string inverters (with more than one MPPT). The number of components in each PV plant is reported in Table III. Moreover, the first plant (plant #1), whose rated power is 50 kW, does not have a maintenance contract with an external company.

As a consequence, if the components of this PV plant fail, the cost of their repair is paid by the PV owner only. On the contrary, the other PV plants have similar maintenance contracts with companies, which perform any operation of corrective and preventive maintenance. In particular, corrective maintenance includes the replacement of any component in the system, while preventive maintenance includes operations like thermography analysis, electrical isolation checks and current-voltage ($I-V$) curve tracing of PV arrays. In general, in case of failure, the PV owner purchases the replacement components or materials.

IV. RESULTS

A. Evaluation of Reliability using data from literature

According to (8), the reliability of each PV plant is evaluated in this sub-section using the failure rates assumed in Table I.

Table IV reports the estimated reliability of the groups of components for each PV plant after 10 operation years. In general, the reliability is almost null for PV modules, DC/AC converters and fuses: this means that, after 10 years, it is very likely that at least one of these components fails, requiring a repair or a complete replacement. Obviously, the reliability of the whole plants after 10 years is zero: a failure of at least one component is certain. Fig. 5 presents the estimated profile of reliability function of the PV plants under study during 3 years. Except for PV plants from #1 to #4, it is very likely for the other systems to require maintenance starting from the first operation year. On the contrary, the reliability function of plants from #1 to #4 after one year, i.e. the probability that each component works properly, ranges between 0.02 (#4) and 0.49 (#1). This condition is due to the dependency of a system reliability on the number of components: in particular, it decreases with a larger number of installed devices. As shown in Table IV, DC/AC converters are the devices presenting the lowest reliability after 10 years: thus, they present the highest probability of failure. As a consequence, their impact on the systems reliability is the greatest one: PV systems from #5 to #10 have a larger number of inverters with respect to the others and, thus, a null reliability after one year.

TABLE III. NUMBER OF COMPONENTS IN PV PLANTS UNDER ANALYSIS

Plant	#1	#2	#3	#4	#5	#6	#7	#8	#9	#10
Nominal power [kW]	50	150	260	550	1000	1000	1000	1000	1800	1800
Number of components										
PV modules	216	1472	1125	2375	4284	4340	4340	4420	7820	7920
Connectors	432	2944	2250	4750	8568	8680	8680	8840	15760	15840
Fuses	32	410	142	224	380	434	434	442	804	792
Diodes	16	205	71	112	190	217	217	221	402	396
DC breakers	16	19	23	50	69	14	14	17	134	132
DC/AC converters	4	9	15	12	69	2	3	3	134	132
AC breakers	4	9	15	12	69	2	3	3	3	3
Grid interface	1	1	2	2	2	14	14	17	13	15
General AC breaker	1	1	2	2	2	1	1	1	3	3

TABLE IV. ESTIMATED RELIABILITY AFTER 10 YEARS FOR GROUPS OF COMPONENTS

Plant	#1	#2	#3	#4	#5	#6	#7	#8	#9	#10
Nominal power [kW]	50	150	260	550	1000	1000	1000	1000	1800	1800
Reliability of groups of components after 10 years										
PV modules	0.11	0.99	0	0.31	0	0	0	0	0	0
Connectors	0.92	0.58	0.66	0.42	0.21	0.20	0.20	0.20	0.06	0.05
Fuses	0.21	0	0	0	0	0	0	0	0	0
Diodes	1	0.99	1	1	0.99	0.99	0.99	0.99	0.98	0.98
DC breakers	0.82	0.79	0.75	0.54	0.42	0.84	0.84	0.81	0.19	0.19
DC/AC converters	0.19	0.02	0	0	0	0	0	0	0	0
AC breakers	0.33	0.08	0.02	0.04	0	0.76	0.76	0.76	0.43	0.43
Grid interface	0.89	0.89	0.80	0.80	0.80	0.21	0.21	0.15	0.23	0.19
General AC breaker	0.76	0.76	0.57	0.57	0.57	0.57	0.43	0.43	0.43	0.43
ENTIRE PLANT	0	0	0	0	0	0	0	0	0	0

Then, the $MTTF$ is estimated for each plant using the failure rates from literature. This parameter is evaluated according to the following equation:

$$MTTF = 1 / \sum_{i=1}^n m_i \lambda_i \quad (9)$$

As previously described, the $MTTF$ and the reliability function depend on the number of identical components in the system and their failure rate. In fact, PV plants with larger number of components are characterized by a lower $MTTF$, which decreases from 4550 h (plant #1) to 180 h (plant #10).

B. Evaluation of Reliability using data from maintenance reports

In the second part of the analysis, the $MTTF$ of PV plants is evaluated starting from data of industrial maintenance reports in the years 2016-2018. These results are compared to the outputs from previous sub-section in order to check the accuracy of the models described in section II. The list of the faults from industrial maintenance reports, divided per category and plant, are reported in Table V. The $MTTF$ of each PV plant is obtained as the ratio between the operation time and the number of failures occurring to groups of components. Fig. 6 compares the $MTTF$ evaluated with data from reports and the results from sub-section IV.A using failure rates from literature. In general, the data from literature slightly underestimate the $MTTF$ for plants from #2 to #5, i.e. the components of these systems operate for a longer period without failures. On the contrary, the other plants fail with a higher frequency than expected. The models used in sub-section IV.A use failure rates taken from literature, which are average values evaluated from large experimental datasets of failures. Thus, low deviations between models using these failure rates and data from industrial maintenance reports cannot be guaranteed. However, the ratio between the deviations in terms of hours and the operation hours of each plant is a parameter of interest, which has to be low. In the present analysis, except for plant #1, this ratio ranges between 1% (#7, #9 and #10) and 8% (#5), corresponding to deviations between literature data and data from maintenance reports in the range about 50–350 h. Thus, these results are reasonably close to the outputs evaluated with data from literature. In addition, the comparison between data from literature and from these maintenance reports provides useful information for plant #1. In fact, in this case, the plant performs much worse than expected, having a $MTTF$ (≈ 1500 h) that is about 1/3 of models prediction (≈ 4500 h). Thus, a deeper analysis is performed in order to identify the components contributing to this bad behavior. In this plant, an error regarding the installation of

fuses has been detected. In particular, they were directly exposed to sun irradiation, resulting in large thermal stresses that damaged their enclosures in short time. Consequently, this plant is not statistically relevant for the present RA and the following sections will not focus on this plant.

The *MTTR* of the plants is taken from the maintenance reports. Then, this quantity is calculated for each group of components: in particular, starting from the maintenance reports of each system, it is calculated as the ratio between the global repair time and the number of repairs of each group of components.

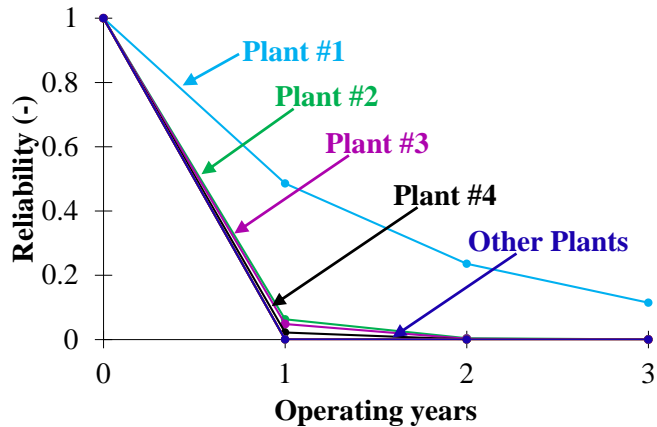

Fig. 5. Reliability function of the PV plants under study during 3 years

TABLE V. NUMBER OF MAINTENANCE WORKS

Plant	#1	#2	#3	#4	#5	#6	#7	#8	#9	#10
Nominal power [kW]	50	150	260	550	1000	1000	1000	1000	1800	1800
Reliability of groups of components after 10 years										
PV modules	-	4	3	1	1	-	-	-	-	-
Connectors	1	1	2	1	3	2	2	-	3	-
Fuses	3	-	1	1	1	43	29	47	3	22
Diodes	-	-	-	-	-	-	-	-	-	-
DC breakers	-	-	-	-	-	-	-	2	-	-
DC/AC converters	2	-	2	4	9	2	6	4	91	74
AC breakers	-	-	1	1	-	-	-	-	-	2
Grid interface	-	1	-	-	-	-	-	-	-	-
General AC breaker	-	-	-	-	-	-	-	-	-	2

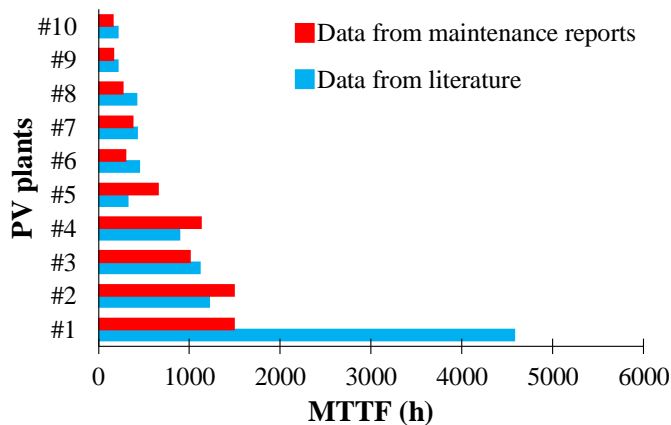

Fig. 6. MTTF of PV plants evaluated using data from literature or from maintenance reports

Fig. 7 reports the *MTTR* associated to the analyzed PV plants: generally, *MTTR* decreases with increasing rated power. As mentioned in Section III, except for #1, the other plants have a maintenance contract with companies. In general, the contracts of the PV systems under analysis are similar but they become more restrictive in terms of speed of maintenance operation for larger capacities. This means that, for plants with larger rated power, the duration of maintenance operations is lower: in particular, the

delay between the detection of a failure and the restoration to its full operation is lower, thus, reducing the production loss. Generally, plants with low rated power (up to few decades of kW) do not have a maintenance contract: in fact, the probability of failure of the plant may be minimized under specific design indications [29]. In particular, these consist of the installation of high efficiency PV modules, the oversizing of DC/AC converters with respect to the rated power of PV generators and the minimization of the number of parallel-connected PV strings. The last indication affects the number of installed fuses, which are connected to each PV string, being the devices most subject to failures due to over temperature issues. Under such design characteristics, small PV plants may avoid to pay maintenance contracts. PV plants from #1 to #5 results in the worst *MTTRs*; on the contrary, PV systems from #6 to #10 exhibit the lowest *MTTRs*, which range from ≈ 13 h (#6) to ≈ 15 h (#10).

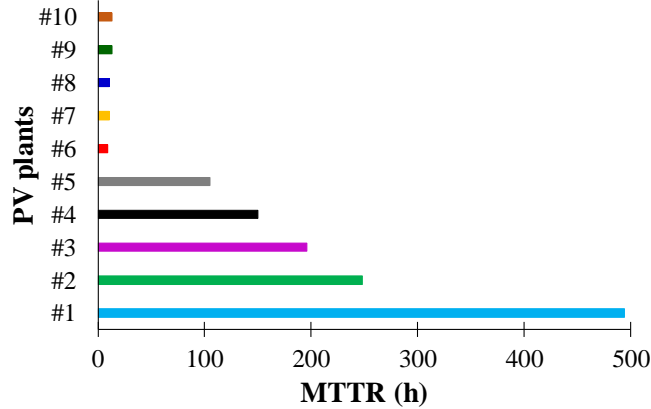

Fig. 7. *MTTR* of PV plants under study

These plants have restrictive maintenance contracts with the same company, which guarantees an availability higher than 90%. Moreover, they have ground-mounted PV generators, which are easier to repair or replace with respect to the rooftop arrays in plants from #1 to #5.

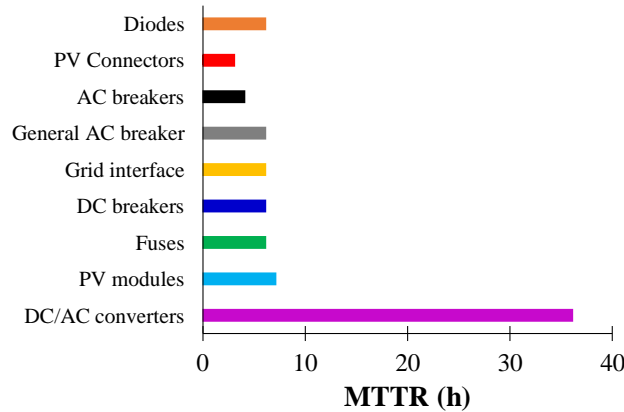

Fig. 8. *MTTR* per category of failure

Fig. 8 shows the *MTTRs* per group of component: the replacement or the repair of inverters due to hardware/software issues requires an average time of 36 h (the largest), while the other components of the plants are repaired within 10 h.

C. Evaluation of annual energy losses and availability

The yearly energy loss is evaluated for each plant. In particular, it is calculated as the difference between measured PV production and the expected generation in the same time interval. The first term is taken from the monitoring system of each plant; in case of failures, the second term is calculated starting from the performance of similar converters (in terms of number, tilt and azimuth of PV modules) that are well operating in the same plant. If this information is not available, e.g. there are not similar arrays to faulty ones or the whole plant is disconnected, the second term is evaluated using proper theoretical models [30].

In the plants under study, proper energy meters are installed after each centralized inverter in order to monitor the energy output of each PV system. On the contrary, this information is not available with string and multi-string converters because the installation of energy meters would be expensive due to the large number of inverters. For this reason, in case of maintenance or failures, the expected PV generation E_{PV} in each time interval Δt is evaluated as follows:

$$E_{PV}(\Delta t) = H_g \cdot S_{PV} \cdot \eta_{STC} \cdot PR \cdot \eta_{deg} \cdot \eta_{PCU} \quad (10)$$

where H_g is the global irradiation on the PV generators, S_{PV} is PV surface area, η_{STC} is the efficiency of PV modules at Standard Test Conditions (STC, irradiance = 1000 W/m² and cell temperature = 25 °C), PR is the Performance Ratio of the generator [29] and η_{deg} is an efficiency taking into account the degradation of PV modules. The PR has been evaluated from the total generated energy of the plants during days without failures or maintenance operations: it results almost constant and equal to $\approx 80\%$. Regarding η_{deg} , an experimental loss of performance of $\approx 0.87\%/year$ [31] has been assumed. The results of the analysis are the following: the highest energy loss is associated to plant #1 ($\approx -8\%$). Regarding PV systems from #2 to #4, their energy loss is much lower ($\approx -1\%$): this is due to the benefits of having maintenance contracts, which lower the $MTTR$ and, thus, the related energy loss. The energy loss associated to plants from #5 to #10 is negligible ($< -1\%$): this is due to even more restrictive maintenance contracts.

TABLE VI. AVAILABILITY OF PV PLANTS UNDER STUDY

Plant	Availability
#1	75%
#2	85%
#3	83%
#4	88%
#5	86%
#6	95%
#7	96%
#8	94%
#9	91%
#10	91%

Finally, the $MTTF$ and the $MTTR$ evaluated using data from maintenance reports permit to assess the availability of the plants according to (3).

The results are reported in Table VI: plant #1 has the lowest availability ($\approx 75\%$), while this ranges between $\approx 83\%$ and $\approx 88\%$ for systems from #2 to #5. The availability function of the other plants, which have the additional availability requirement in their contract, ranges from $\approx 91\%$ (#9 and #10) to $\approx 96\%$ (#7).

V. COMPARISON WITH OTHER RES POWER PLANTS

The results of the analysis are compared with the reliability of some PV systems and wind power plants investigated in literature. In particular, [21] performs a reliability and availability analysis of 7 PV systems with rated power ranging from 100 kW to 2.5 MW. As presented in this work, the reliability of PV systems decreases with increasing rated power. After 1 year, the 100 kW plant has the highest reliability (≈ 0.72), while the systems with more than 1.5 MW have reliability equal to zero (Fig. 9). In [36], failure rates are collected from literature in different scan times and the median values of the sorted data for each group of components is identified in order to reduce the uncertainties of the collected data. Nevertheless, the reliability of these plants is, generally, higher with respect to results in this work. This condition is due to the assumed failure rates, which are different from the ones assumed in the first part of this analysis. However, the low deviations presented in this work confirm the quality of the adopted values. Regarding the components of the plants, the DC/AC converters have the highest failure rate ($4.03 \cdot 10^{-5}$ failures/hour). However, this value is ten times lower than the failure rate assumed in the present work for centralized inverters ($1.3 \cdot 10^{-4}$ failures/hour). The $MTTR$ of converters in [21] (≈ 245 h) is about ten times higher than results in this work (≈ 36 h). As a consequence, the availability of the plants in [21] is relatively low and this effect is more evident for plants with a large number of inverters.

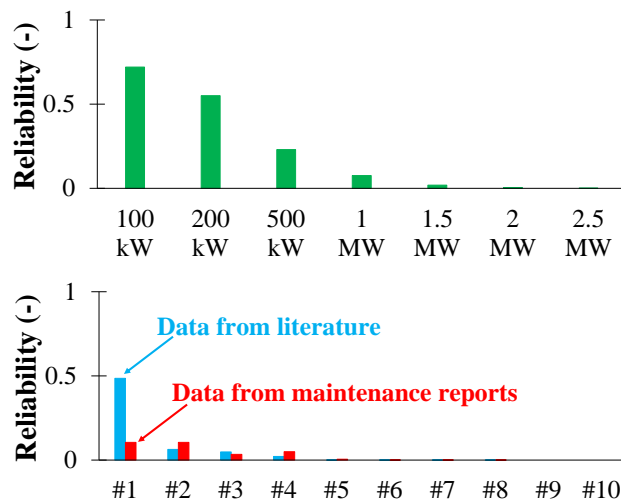

Fig. 9. Reliability of PV plants analyzed in [21] (top) and in this work (bottom)

Indeed, in [21] the availability of PV plants with rated power up to 500 kW is higher than 93%. On the contrary, it is lower than 90% for the others, being worse than PV systems from in the present work with similar rated power. Research paper [22] confirms the effect of inverters on systems reliability and availability due to their high probability of failure and *MTTR*.

Most of subsystems in Wind Turbines (WTs) may fail during operation, including rotors with their blades, pitch control systems, gearboxes and bearings, brakes, yaw systems, generators, power electronics and automatic controls. A typical scheme presenting the components of wind farms is reported in [32]. In this paper, 18 free reliability data for both onshore and offshore WTs are presented, including more than 18000 WTs. The subassemblies exhibiting the highest average failure rates include the electrical subassembly (DC/AC converters, transformers and electrical protections) and the pitch system. Indeed, these components may fail up to twice per year ($\lambda \approx 2.28 \cdot 10^{-4}$ failures/hour). On the contrary, the most reliable components are the brakes; the shafts and the bearings; the nacelle and the structure (tower and foundation). The failure rates of the systems vary from ≈ 1 to ≈ 10 failures/year, corresponding to a reliability which is comparable to most of plants analyzed in the present paper. Indeed, after 1 year, it ranges between 0 and 0.37.

Comparing variable speed and fixed-speed WTs, many faults affect the subsystems centered on the drive train, including the main-shaft and the bearings; the gearbox; the rotor brake; the blades and the generator. For fixed-speed turbines, the failure rates for drive train components, mainly gearbox and blades, are remarkable. On the contrary, for variable-speed turbines, the failure rates of drive train are greatly reduced, but the failure rates of control and electric components (in particular the pitch mechanism and sensors) are increased.

Moreover, WTs are often located in remote areas and their structures are hard-to-access. The consequence of these factors is an increase of their Operation and Maintenance (O&M) cost. In particular, repair and maintenance of WTs require extensive usage of cranes and lifting equipment. A consequent increase in the O&M cost is generated with respect to PV plants. Thus, poor reliability reduces the availability of wind power plants, which is, generally, lower than PV systems. Indeed, [33] reports the availability of a wind farm, installed on a very complex terrain with cold winter climate. It includes 32 WTs grouped in three contiguous wind parks of 11, 11 and 10 WTs, respectively; the availability in six months has been estimated equal to 69%, 62% and 71%, respectively. However, in case of wind farms placed on a smooth terrain with mild climate, the availability may be higher than 90% [33].

VI. CONCLUSIONS

The present paper performs a maintenance, reliability and availability analysis of ten PV systems, with different inverter configuration and capacity, ranging from 50 kW to 1.8 MW. The models using failure rates from literature estimate *MTTF* values which are reasonably close to data from industrial maintenance reports, ranging between ≈ 130 h and ≈ 1500 h. Regarding the *MTTR*, it ranges between ≈ 13 h (#6) and ≈ 500 h (#1). The plants include a maintenance contract with companies, lowering their *MTTR*, except for plant #1, which does not have a contract (resulting in the largest *MTTR*). In particular, plants from #6 to #10 exhibit the lowest values, ranging from ≈ 13 h (#6) to ≈ 15 h (#10). This is due to an additional requirement in their contract: in fact, the company performing the maintenance of these plants guarantees a minimum availability equal to 90%. Moreover, they have ground-mounted PV generators, which are easier to repair or replace with respect to the rooftop arrays in plants from #1 to #5. The presence of maintenance contracts increases the availability (between $\approx 83\%$ and $\approx 96\%$) and limits the energy losses, which are about $\approx 1\%$ or lower. As a conclusion, energy losses = -1% may be set as a desirable value for PV plants with rated power from a few kilowatts to several megawatts. The corresponding availability should be larger than $\approx 83\%$ from few kilowatts up to few hundreds of kilowatts. On the contrary, plants with rated power of several MW are expected to perform correctly for more than 90% of operation time. Comparing the reliability of PV plants with WTs, the performance is similar in terms of reliability, while the availability of wind power plants is, generally, lower due to the higher O&M costs.

ACKNOWLEDGMENT

The authors gratefully acknowledge the contributions of Mr. D. Forastiere (CEO of TGE S.r.l.), for providing the industrial maintenance reports of plants from #1 to #5 in the years 2016-2017, and Dr.s. G. Libertini and C. Di Stefano (Rios Rinnovabili S.r.l.), for providing the industrial maintenance reports of plants from #6 to #10 in the years 2016-2018.

REFERENCES

- [1] A. Mazza, G. Chicco, M. Rubino, Hierarchy Process Multi-objective distribution system optimization assisted by Analytic Hierarchy Process, 2012 IEEE International Energy Conference and Exhibition (ENERGYCON 2012), 9-12 Sep 2012, Firenze (Italy)
- [2] P.M. De Quevedo, J. Contreras, A. Mazza, G. Chicco, R. Porumb, "Reliability Assessment of Microgrids With Local and Mobile Generation, Time-Dependent Profiles, and Intraday Reconfiguration," *IEEE Transactions on Industry Applications* vol. 54, 2018, pp 61-72.
- [3] A. Khalilnejad, M. M. Pour, E. Zarafshan and A. Sarwat. "Long term reliability analysis of components of photovoltaic system based on Markov process. SoutheastCon 2016. Norfolk, VA. 2016. pp. 1-5.
- [4] M. Chang et al., "The reliability investigation of PV junction box based on IGW worldwide field database," 2015 IEEE 42nd Photovoltaic Specialist Conference (PVSC), New Orleans, LA, 2015, pp. 1-4.
- [5] F. Obeidat and R. Shuttleworth, "Reliability prediction of PV inverters based on MIL-HDBK-217F N2," 2015 IEEE 42nd Photovoltaic Specialist Conference (PVSC), New Orleans, LA, 2015, pp. 1-6.
- [6] K. Yedidi, S. Tatapudi, J. Mallineni, B. Knisely, J. Kutiche and G. TamizhMani, "Failure and degradation modes and rates of PV modules in a hot-dry climate: Results after 16 years of field exposure," 2014 IEEE 40th Photovoltaic Specialist Conference (PVSC), Denver, CO, 2014, pp. 3245-3247.
- [7] A. Altamimi and D. Jayaweera, "Reliability performances of grid-integrated PV systems with varying climatic conditions," IET International Conference on Resilience of Transmission and Distribution Networks (RTDN 2017), Birmingham, 2017, pp. 1-6.
- [8] Y. Rongbin, L. Guixiong and Xiaoli. "Failure Risk Analysis of the PV Modules Based on the Improved FMECA Method." Fifth International Conference on Instrumentation and Measurement. Computer, Communication and Control, Qinhuangdao, 2015, pp. 1166-1170.

- [9] X. Shi and A. M. Bazzi. "Solar photovoltaic power electronic systems: Design for reliability approach." 17th European Conference on Power Electronics and Applications, Geneva. 2015, pp. 1-8.
- [10] F. Spertino, E. Chiodo, A. Ciocia, G. Malgaroli and A. Ratclif, "Maintenance Activity, Reliability Analysis and Related Energy Losses in Five Operating Photovoltaic Plants," 2019 IEEE International Conference on Environment and Electrical Engineering and 2019 IEEE Industrial and Commercial Power Systems Europe (EEEIC / I&CPS Europe), Genova, Italy, 2019, pp. 1-6.
- [11] Y. Song and B. Wang. "Survey on Reliability of Power Electronic Systems," *IEEE Transactions on Power Electronics*. vol. 28. no. 1. pp. 591-604. Jan. 2013
- [12] YF. Obeidat and R. Shuttleworth. "Reliability prediction of PV inverters based on MIL-HDBK-217F N2." in *Proc. 2015 IEEE 42nd Photovoltaic Specialist Conf.* pp. 1-6.
- [13] M. Cooper. "Observations on Component Infant Mortality and Burn-In Effectiveness." in *IEEE Transactions on Components and Packaging Technologies*. vol. 31. no. 4. pp. 914-916. December 2008.
- [14] D. J. Smith, "Variable Failure Rates and Probability Plotting," *Reliability, Maintainability and Risk* (Ninth Edition), 2017, Pages 73-85, ISBN 9780081020104.
- [15] T. E. Wing and L. H. Crow. "A model for mean-time-to-repair and mean-logistics-delay-time at the system level." Annual Proceedings on Reliability and Maintainability Symposium. Los Angeles. CA. USA. 1990, pp. 389-393.
- [16] C. Bufi, A. Elasser, M. Agamy. "A system reliability trade-off study for centralized and distributed PV architectures." IEEE 42nd Photovoltaic Specialist Conference, New Orleans. LA. 2015, pp. 1-5.
- [17] "MTBF, MTTR, MTTA, and MTTF", available at <https://www.atlassian.com/incident-management/kpis/common-metrics>
- [18] E. Topuz, "Reliability and Availability Basics," in *IEEE Antennas and Propagation Magazine*, vol. 51, no. 5, pp. 231-236, Oct. 2009, doi: 10.1109/MAP.2009.5432110.
- [19] F. Spertino, G. Chicco, A. Ciocia, G. Malgaroli, A. Mazza and A. Russo. "Harmonic distortion and unbalance analysis in multi-inverter photovoltaic systems." in *Proc. 2018 International Symposium on Power Electronics, Electrical Drives, Automation and Motion*, pp. 1031-1036.
- [20] T. Oozeki, T. Yamada, K. Kato, T. Yamamoto, "An analysis of reliability for photovoltaic systems on the field test project for photovoltaic in Japan," In: *Proc. ISES Solar World Congress; 2007*, pp. 1628-1632.
- [21] S. Baschel, E. Koubli, J. Roy, R. Gottschalg, "Impact of Component Reliability on Large Scale Photovoltaic Systems' Performance," *Energies* 2018, 11, 1579.
- [22] A. Sayed, M. El-Shimy, M. El-Metwally, M. Elshahed, "Reliability, Availability and Maintainability Analysis for Grid-Connected Solar Photovoltaic Systems," *Energies* 2019, 12, 1213.
- [23] Reliability prediction of electronic equipment. MIL-HDBK-217F. 217F Notice 1, Washington DC, USA, Departement of Defense; 1991-92-95.
- [24] A. Golnas. "PV System Reliability: An Operator's Perspective." in *IEEE Journal of Photovoltaics*. vol. 3. no. 1. pp. 416-421. Jan. 2013.
- [25] D. Kritzinger, "Fault tree analysis," *Aircraft System Safety*, pp. 59-99, 2017.
- [26] A. Carullo, A. Castellana, A. Vallan, A. Ciocia, F. Spertino. "Uncertainty issues in the experimental assessment of degradation rate of power ratings in photovoltaic modules." in *Measurement*. vol. 111, pp. 432-440, 2017.
- [27] G. Zini, C. Mangeant and J. Merten, "Reliability of large-scale grid-connected photovoltaic systems," *Renewable Energy*, vol. 36, pp. 2334-2340, 2011.
- [28] H. Ren, X. Chen and Y. Chen, "Fault Tree Analysis for Composite Structural Damage," *Reliability Based Aircraft Maintenance Optimization and Applications*, pp. 115-131, 2017.
- [29] F. Spertino, F. Corona, "Monitoring and checking of performance in photovoltaic plants: A tool for design, installation and maintenance of grid-connected systems," *Renewable Energy*, vol. 60, pp. 722-732, 2013.
- [30] F. Spertino, J. Ahmad, A. Ciocia, P. Di Leo, "How much is the advisable self-sufficiency of aggregated prosumers with photovoltaic-wind power and storage to avoid grid upgrades?," *Proceedings of IEEE Industry Applications Society Annual Meeting, 2017*, pp. 1-8.
- [31] A. Carullo, A. Castellana, A. Vallan, A. Ciocia, F. Spertino, "In-field monitoring of eight photovoltaic plants: Degradation rate over seven years of continuous operation," *Acta IMEKO*, 7 (4), pp. 75-81, 2018.
- [32] C. Dao, B. Kazemtabrizi, C. Crabtree. "Wind turbine reliability data review and impacts on levelised cost of energy," *Wind Energy* 2019; 22: 1848– 1871. <https://doi.org/10.1002/we.2404>.
- [33] G. Chicco, P. Di Leo, IS. Ilie, F. Spertino, "Operational characteristics of a 27-MW wind farm from experimental data," *Proceedings of the 14th IEEE Mediterranean Electrotechnical Conference (MELECON) 2008; Ajaccio; 2008; 520–526*.